



US00D825463S

(12) **United States Design Patent**
Krivonak et al.

(10) **Patent No.:** **US D825,463 S**

(45) **Date of Patent:** **** Aug. 14, 2018**

(54) **HEAT SPREADER**

(71) Applicant: **GENERAL ELECTRIC COMPANY**,
Schenectady, NY (US)

(72) Inventors: **Andrew Louis Krivonak**, Erie, PA
(US); **Shreenath Shekar Perlaguri**,
Bangalore (IN); **Rajendra**
Yammanuru, Bangalore (IN);
Arunpandi Radhakrishnan, Bangalore
(IN)

(73) Assignee: **General Electric Company**,
Schenectady, NY (US)

(**) Term: **15 Years**

(21) Appl. No.: **29/628,414**

(22) Filed: **Dec. 5, 2017**

Related U.S. Application Data

(62) Division of application No. 29/571,352, filed on Jul.
18, 2016, now Pat. No. Des. 807,824.

(51) **LOC (11) Cl.** **13-02**

(52) **U.S. Cl.**
USPC **D13/118**; D13/179

(58) **Field of Classification Search**
USPC D13/101, 102, 110, 118, 121, 145, 179,
D13/181, 182, 199
CPC ... H01L 23/36; H01L 23/427; H01L 23/3672;
H01L 2924/00; H01L 2924/0002; H01L
21/50; H01L 24/34; F28F 9/22
See application file for complete search history.

(56) **References Cited**

U.S. PATENT DOCUMENTS

D411,509 S * 6/1999 Schlegel D13/118
6,118,177 A * 9/2000 Lischner H01L 23/36
257/704

6,538,320 B1 * 3/2003 Tosaya H01L 21/50
257/706
6,807,058 B2 * 10/2004 Matteson H01L 23/3672
165/185
D503,691 S * 4/2005 Standing H01L 24/63
D13/182
7,005,738 B2 * 2/2006 Zuo H01L 23/427
257/704
7,575,956 B2 * 8/2009 Ararao H01L 21/4878
257/E21.476
D661,261 S * 6/2012 Taylor D13/179
9,353,996 B2 * 5/2016 Chang F28D 15/0266
D773,409 S * 12/2016 Rodarte D13/179

* cited by examiner

Primary Examiner — Derrick Holland

(74) *Attorney, Agent, or Firm* — GE Global Patent
Operation; John A. Kramer

(57) **CLAIM**

The ornamental design for a heat spreader, as shown and
described.

DESCRIPTION

FIG. 1 is a perspective view of a heat spreader depicting our
new design;
FIG. 2 is a top view thereof;
FIG. 3 is a bottom view thereof;
FIG. 4 is an end view thereof;
FIG. 5 is an opposite end view thereof;
FIG. 6 is a side view thereof;
FIG. 7 is an opposite side view thereof; and,
FIG. 8 is an additional perspective view thereof.
The broken lines shown in the figures illustrate the portions
of the design that form no part of the claimed design.

1 Claim, 6 Drawing Sheets

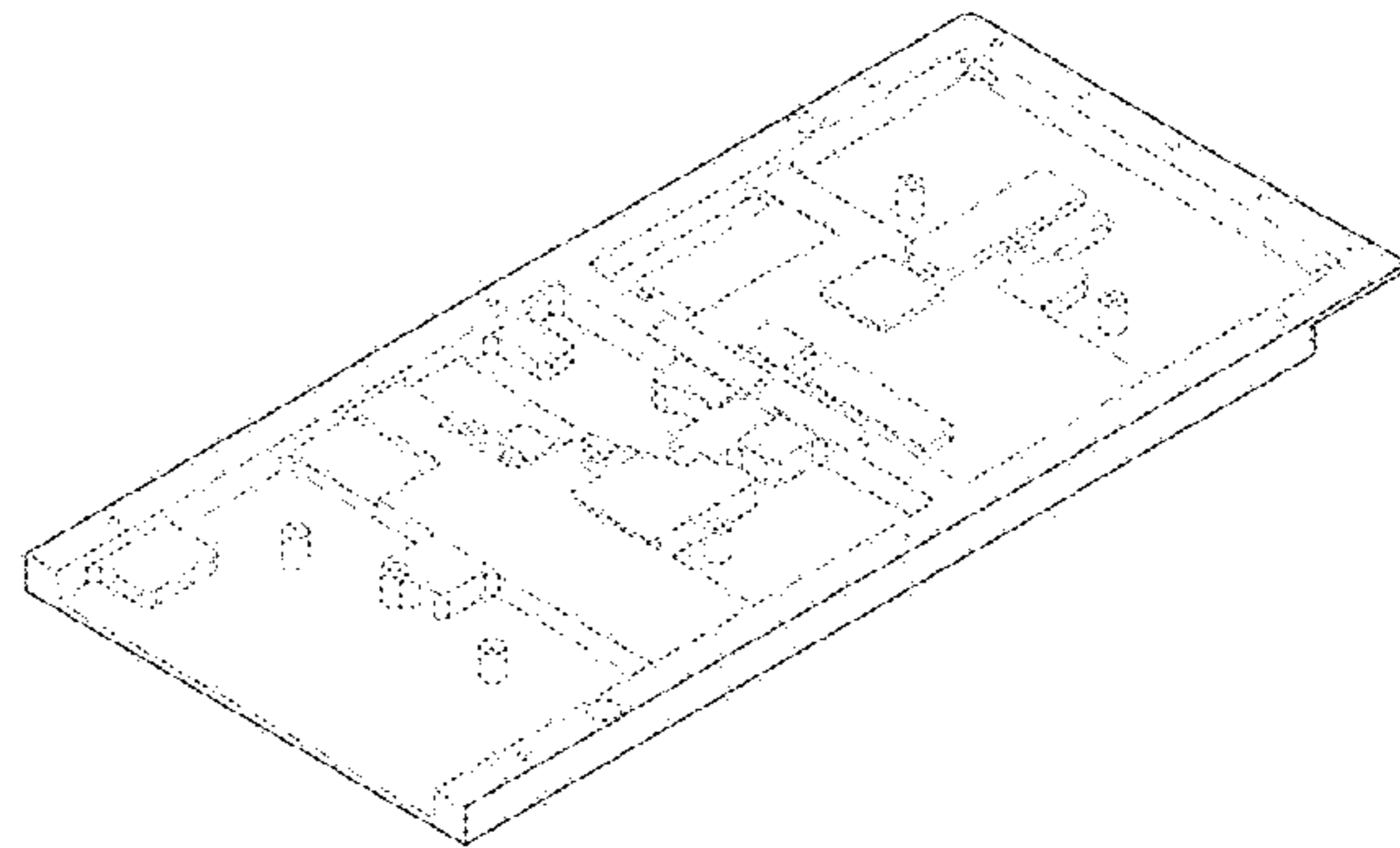
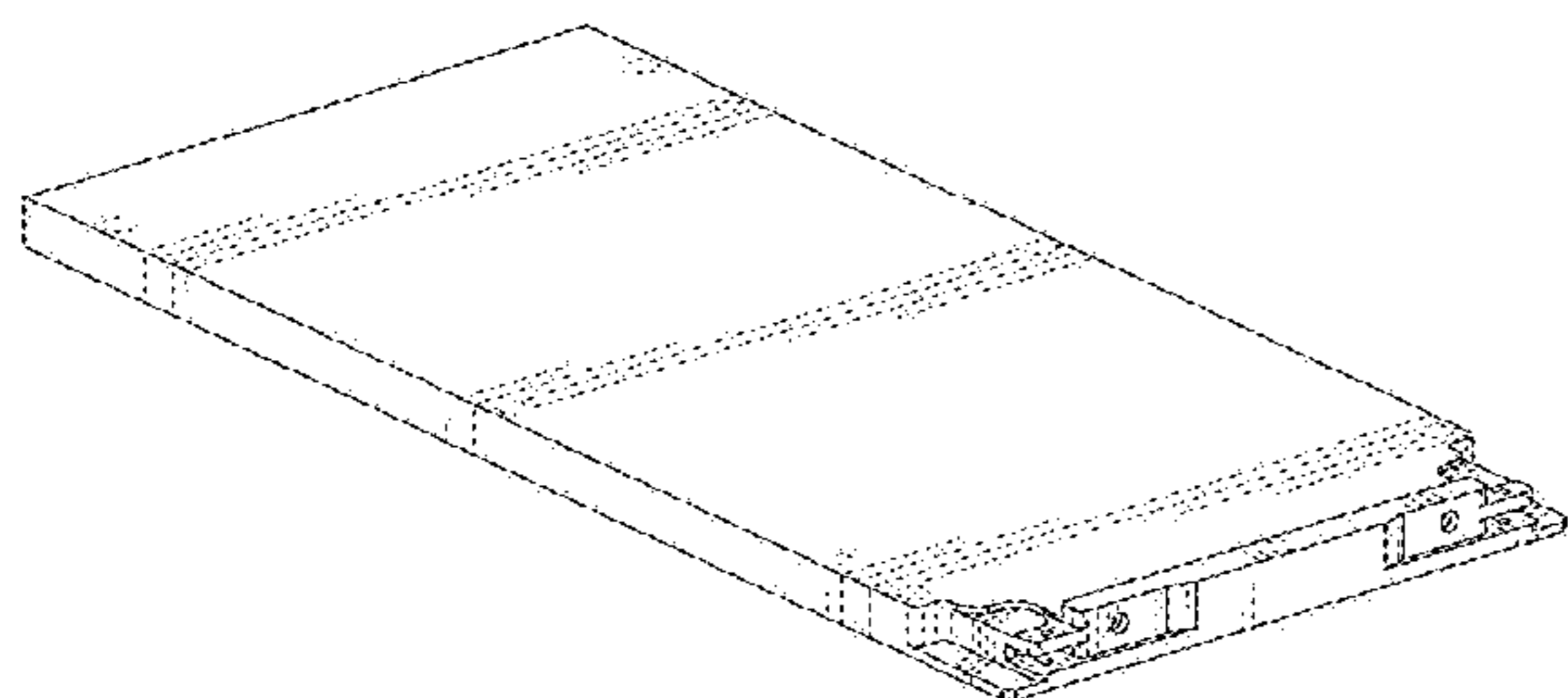

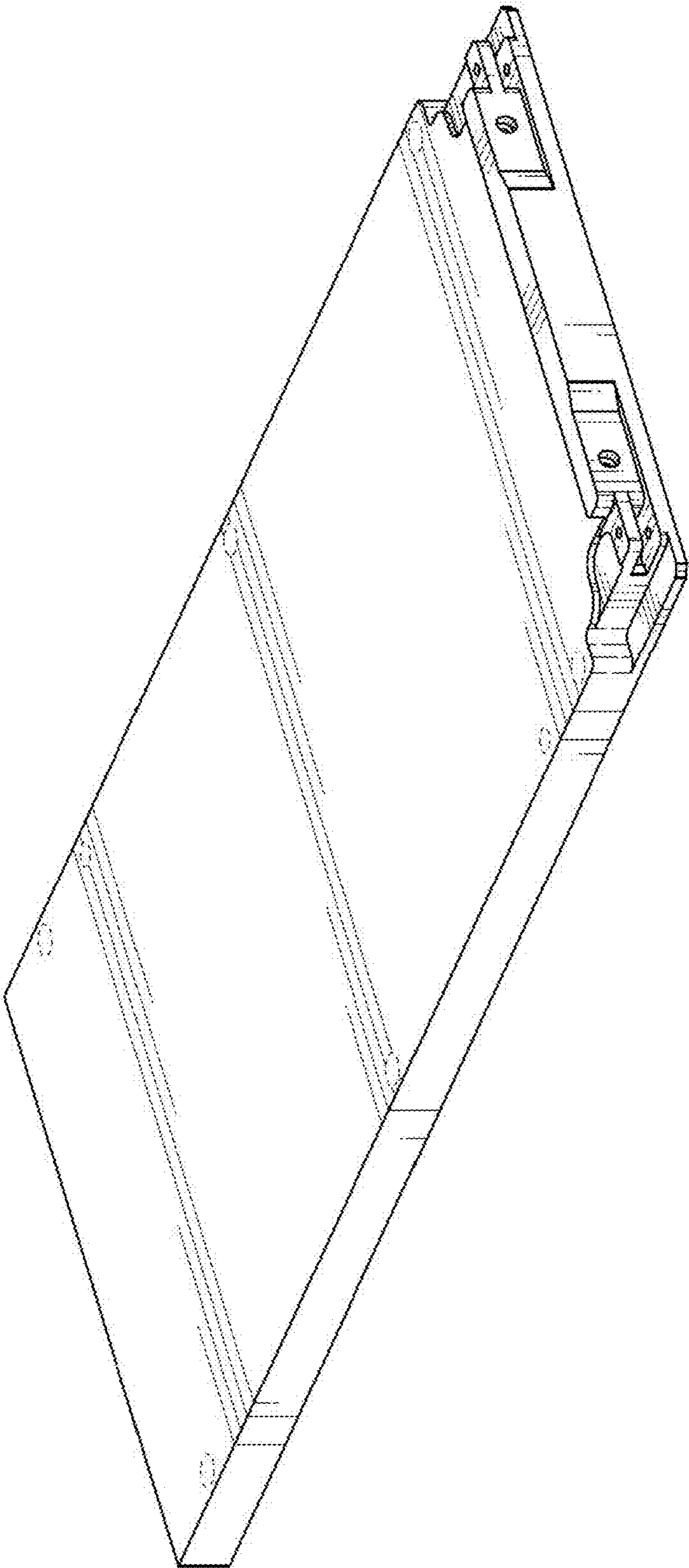

FIG. 1

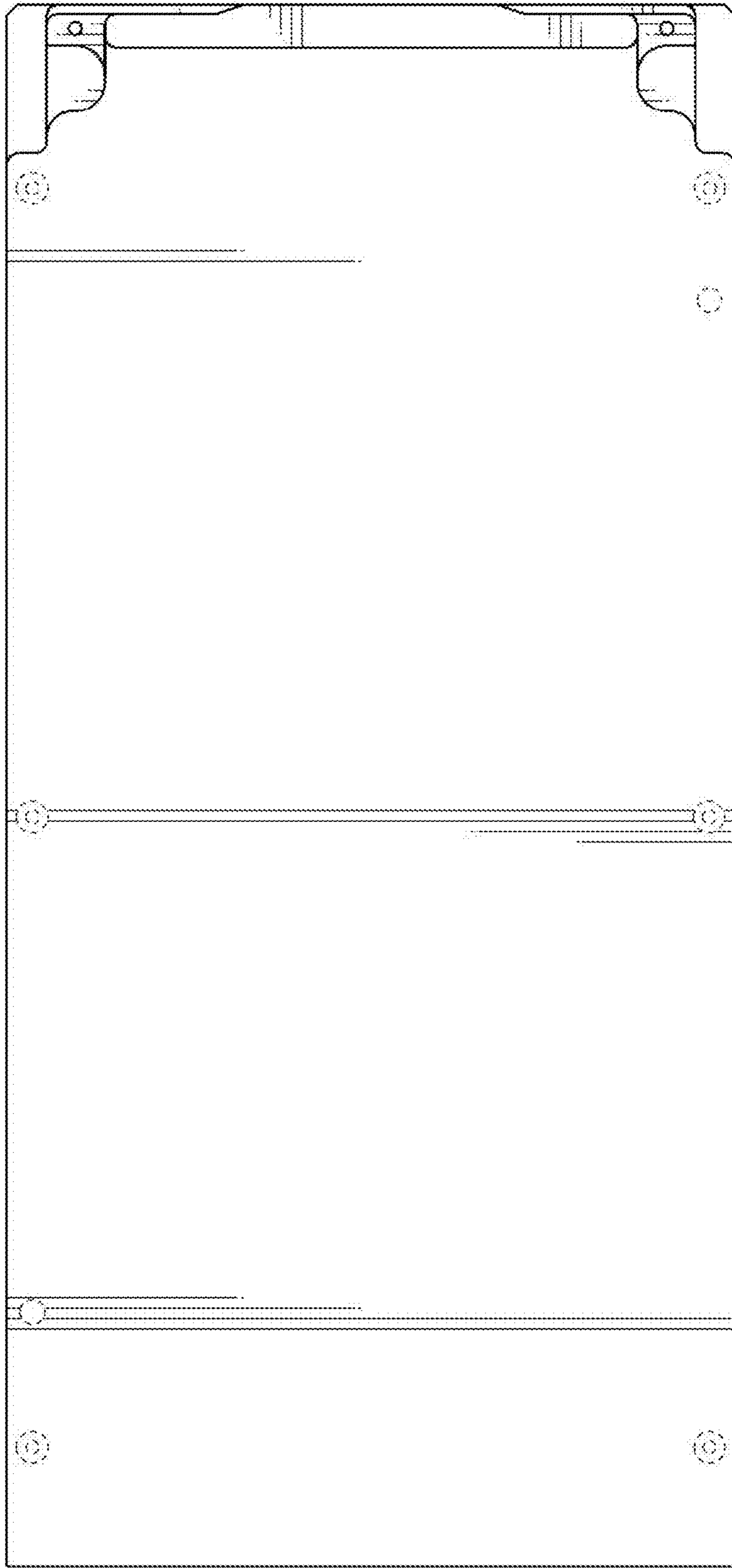

FIG. 2

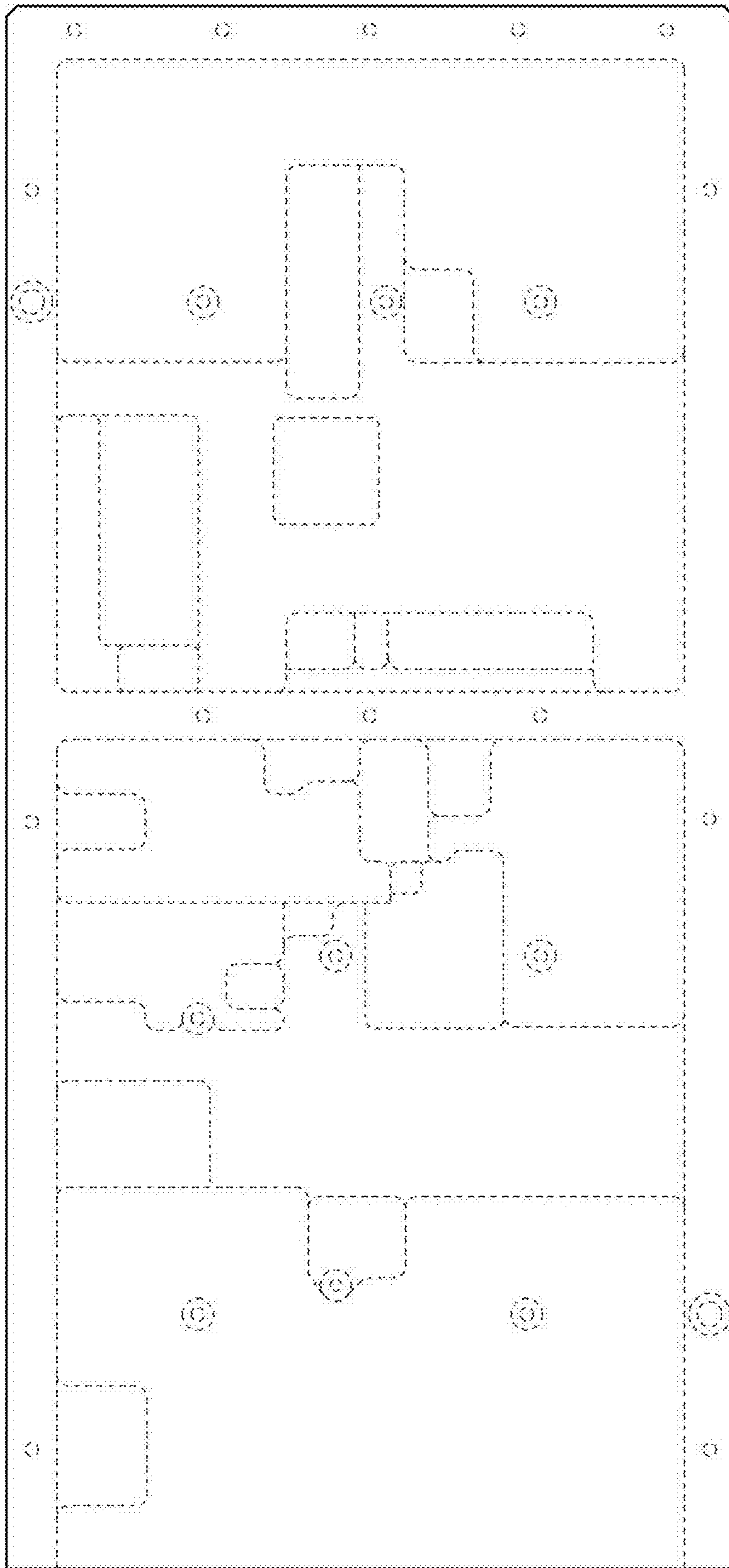

FIG. 3

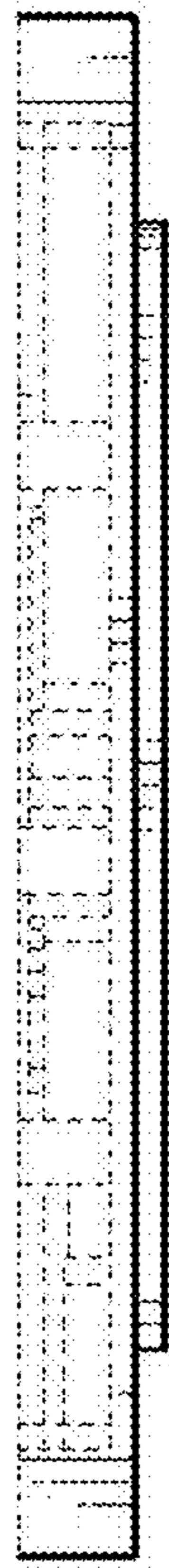

FIG. 4

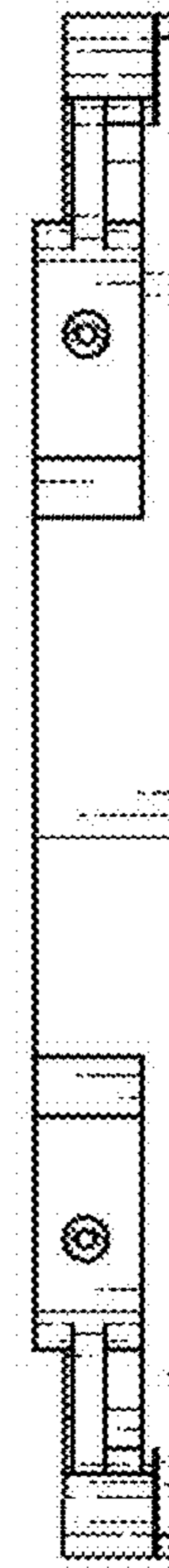

FIG. 5

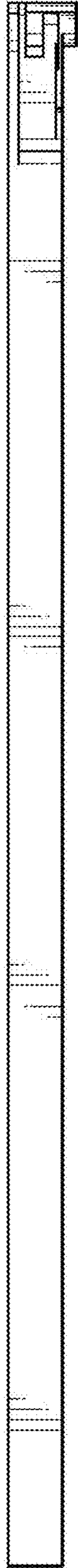

FIG. 6



FIG. 7

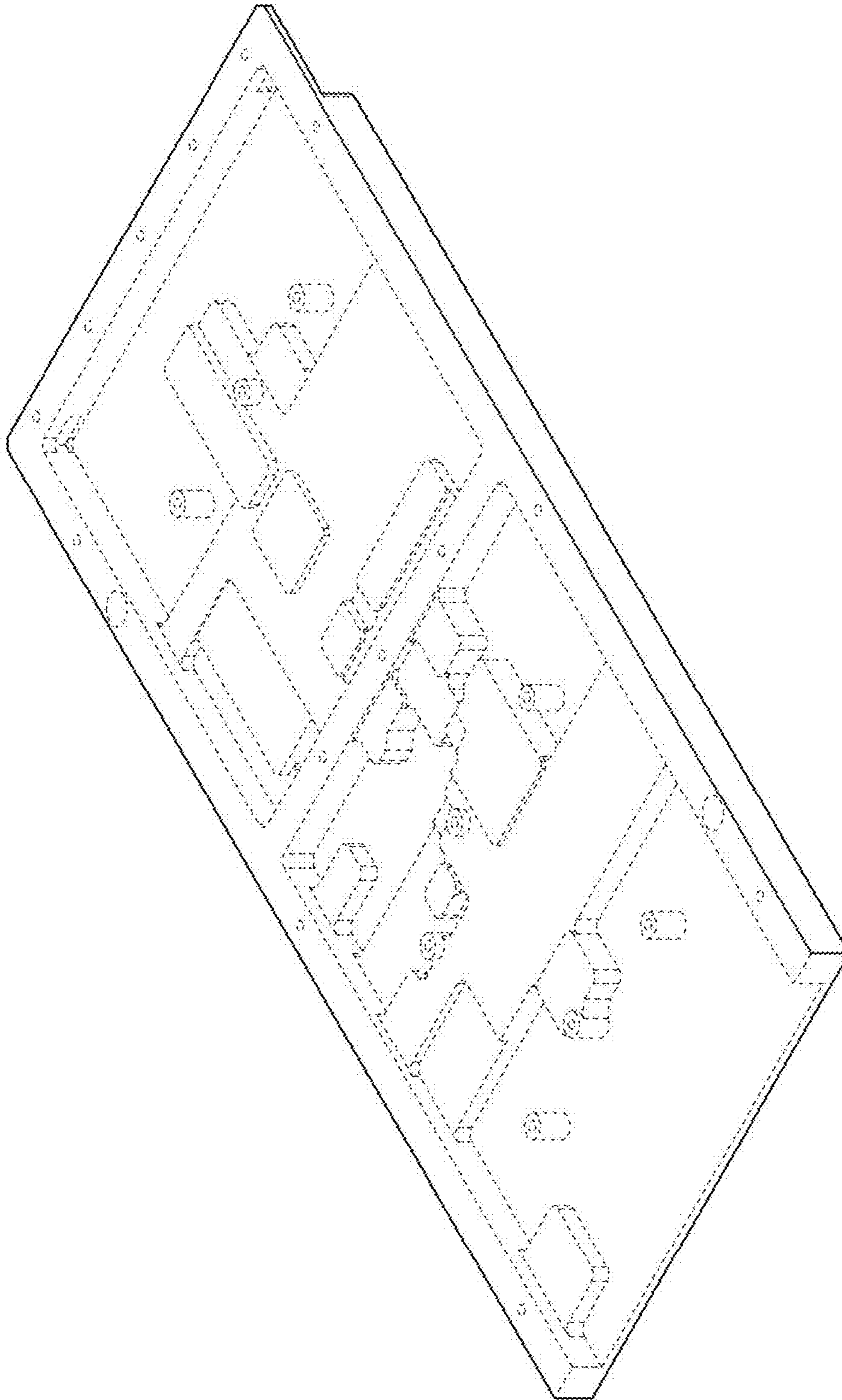

FIG. 8