



US00D825361S

(12) **United States Design Patent**
Hirose et al.

(10) **Patent No.:** **US D825,361 S**

(45) **Date of Patent:** **** Aug. 14, 2018**

(54) **SPECTROMETERS**

(71) Applicant: **HAMAMATSU PHOTONICS K.K.**,
Shizuoka (JP)

(72) Inventors: **Masaki Hirose**, Hamamatsu (JP);
Katsumi Shibayama, Hamamatsu (JP);
Takashi Kasahara, Hamamatsu (JP);
Toshimitsu Kawai, Hamamatsu (JP);
Hiroki Oyama, Hamamatsu (JP); **Yumi**
Teramachi, Hamamatsu (JP); **Mitsushi**
Mineno, Hamamatsu (JP); **Minoru**
Takase, Hamamatsu (JP)

(73) Assignee: **HAMAMATSU PHOTONICS K.K.**,
Hamamatsu-shi, Shizuoka (JP)

(**) Term: **15 Years**

(21) Appl. No.: **35/502,848**

(22) Filed: **Oct. 25, 2016**

(80) **Hague Agreement Data**

Int. Filing Date: **Oct. 25, 2016**

Int. Reg. No.: **DM/093511**

Int. Reg. Date: **Oct. 25, 2016**

Int. Reg. Pub. Date: **Apr. 28, 2017**

(30) **Foreign Application Priority Data**

Apr. 25, 2016 (JP) 2016-009060

Apr. 25, 2016 (JP) 2016-009061

(51) **LOC (11) Cl.** **10-04**

(52) **U.S. Cl.**
USPC **D10/81**

(58) **Field of Classification Search**
USPC D10/81, 47; D13/158, 159, 160
See application file for complete search history.

(56) **References Cited**

U.S. PATENT DOCUMENTS

D603,280 S * 11/2009 Shibayama D10/81

D603,729 S * 11/2009 Shibayama D10/81

D603,730 S * 11/2009 Shibayama D10/81
D603,731 S * 11/2009 Shibayama D10/81
D730,217 S * 5/2015 Yokino D10/81
D733,599 S * 7/2015 Yokino D10/81
D744,878 S * 12/2015 Yokino D10/46

* cited by examiner

Primary Examiner — George D. Kirschbaum

(57) **CLAIM**

The ornamental design for a spectrometer, as shown and described.

DESCRIPTION

1.-2. Spectrometers
1.1 : Perspective
1.2 : Front
1.3 : Back
1.4 : Top
1.5 : Bottom
1.6 : Left
1.7 : Right
1.8 : Partial enlarged vertical sectional view
1.9 : Enlarged top view
1.10 : Partial enlarged perspective view
2.1 : Perspective
2.2 : Front
2.3 : Back
2.4 : Top
2.5 : Bottom
2.6 : Left
2.7 : Right
2.8 : Partial enlarged vertical sectional view
2.9 : Enlarged top view
2.10 : Partial enlarged perspective view
The broken line showing is included for the purpose of illustrating portions of the “article” and forms no part of the claimed design. The dash-dot-dash lines represent the boundary of the claimed design.

1 Claim, 20 Drawing Sheets

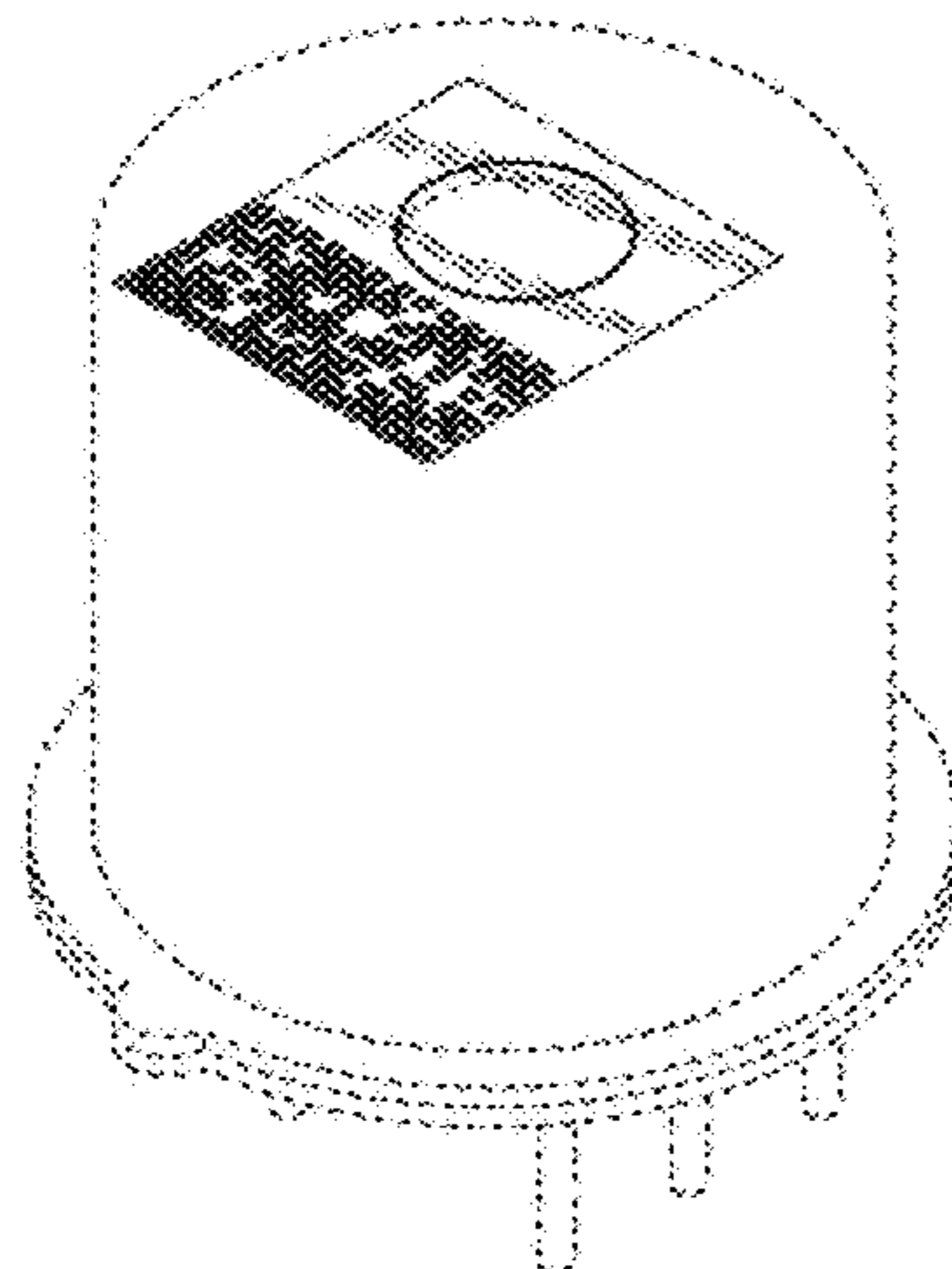

1.1

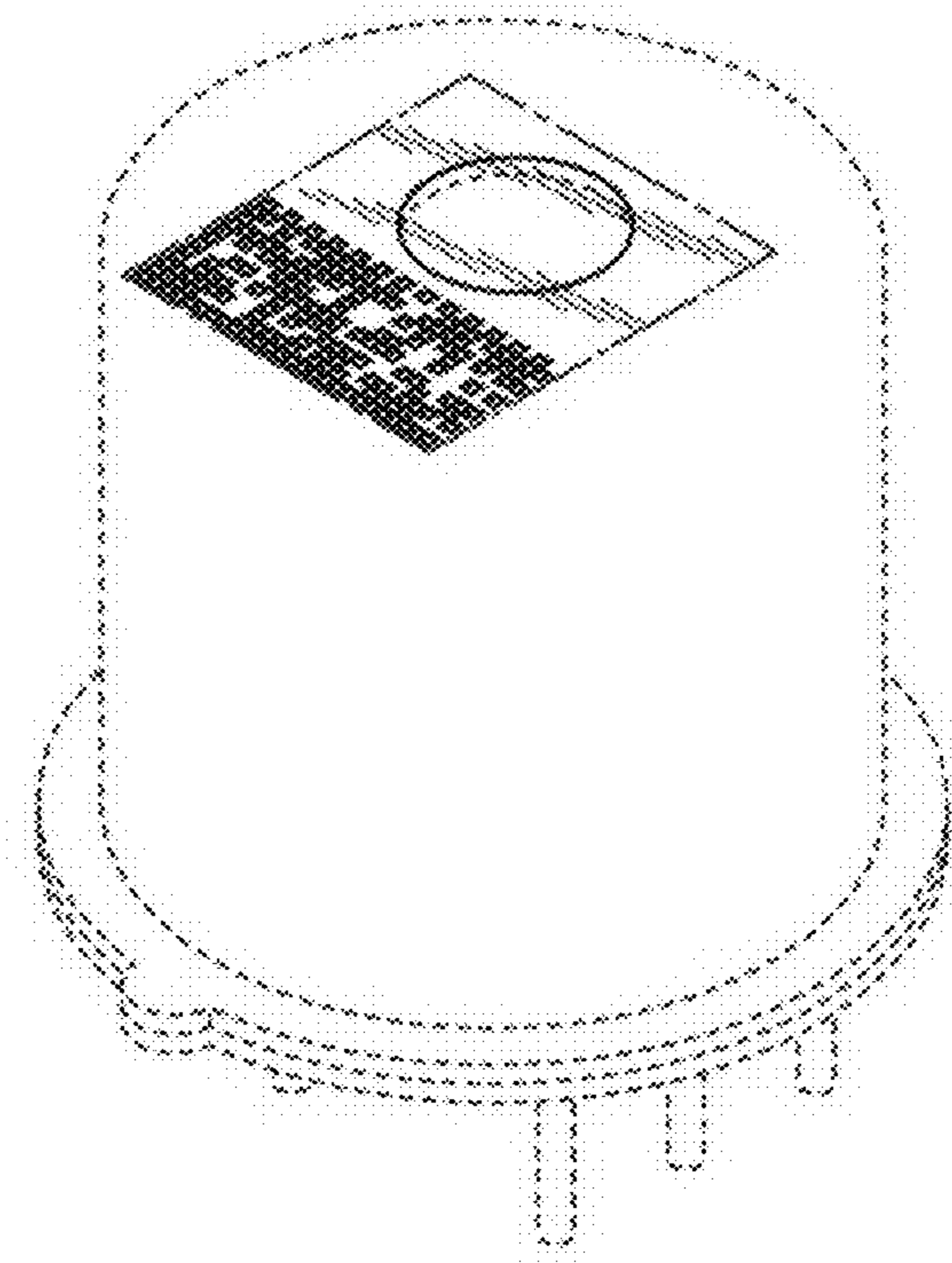

1.2

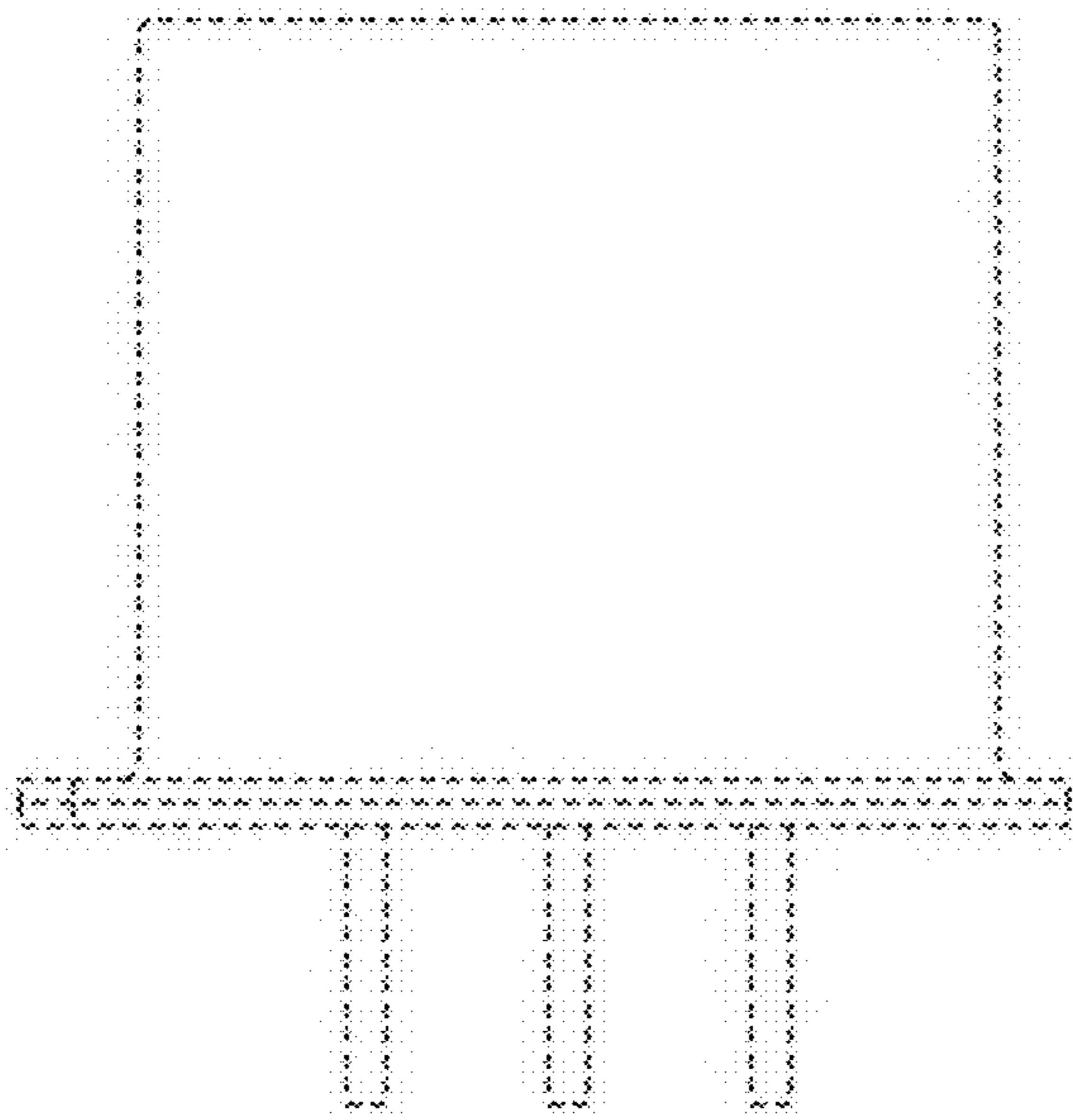

1.3

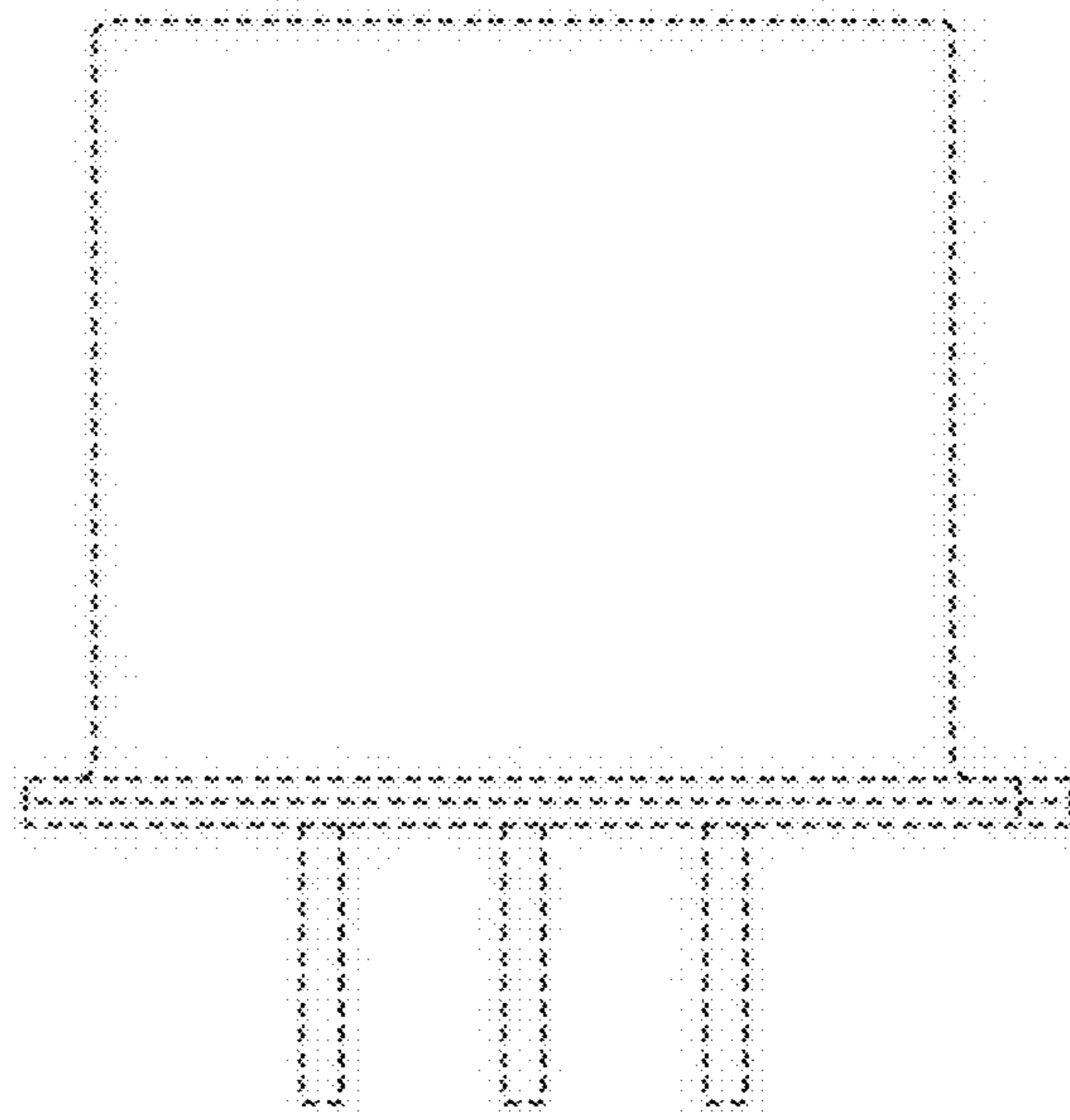

1.4

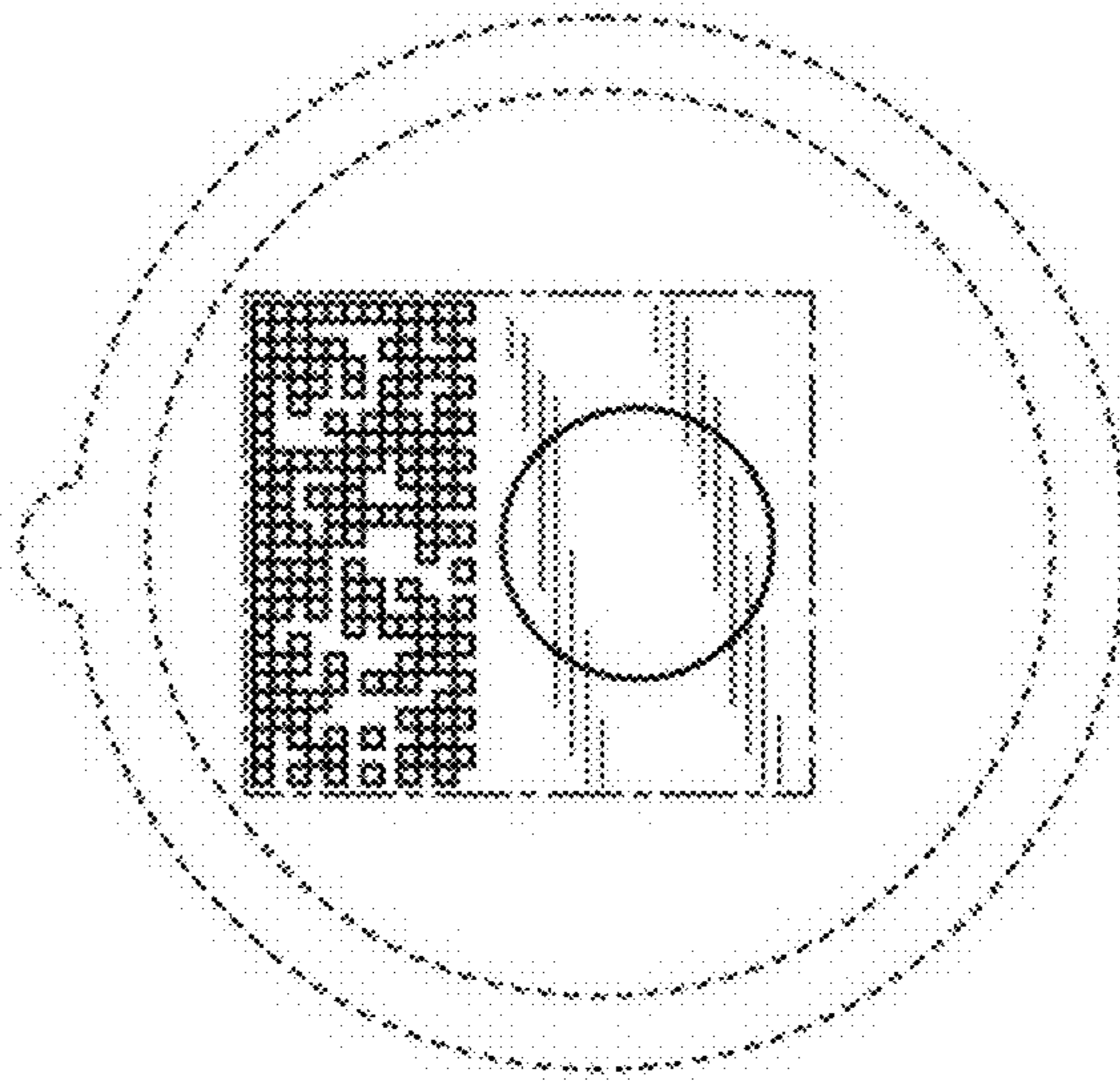

1.5

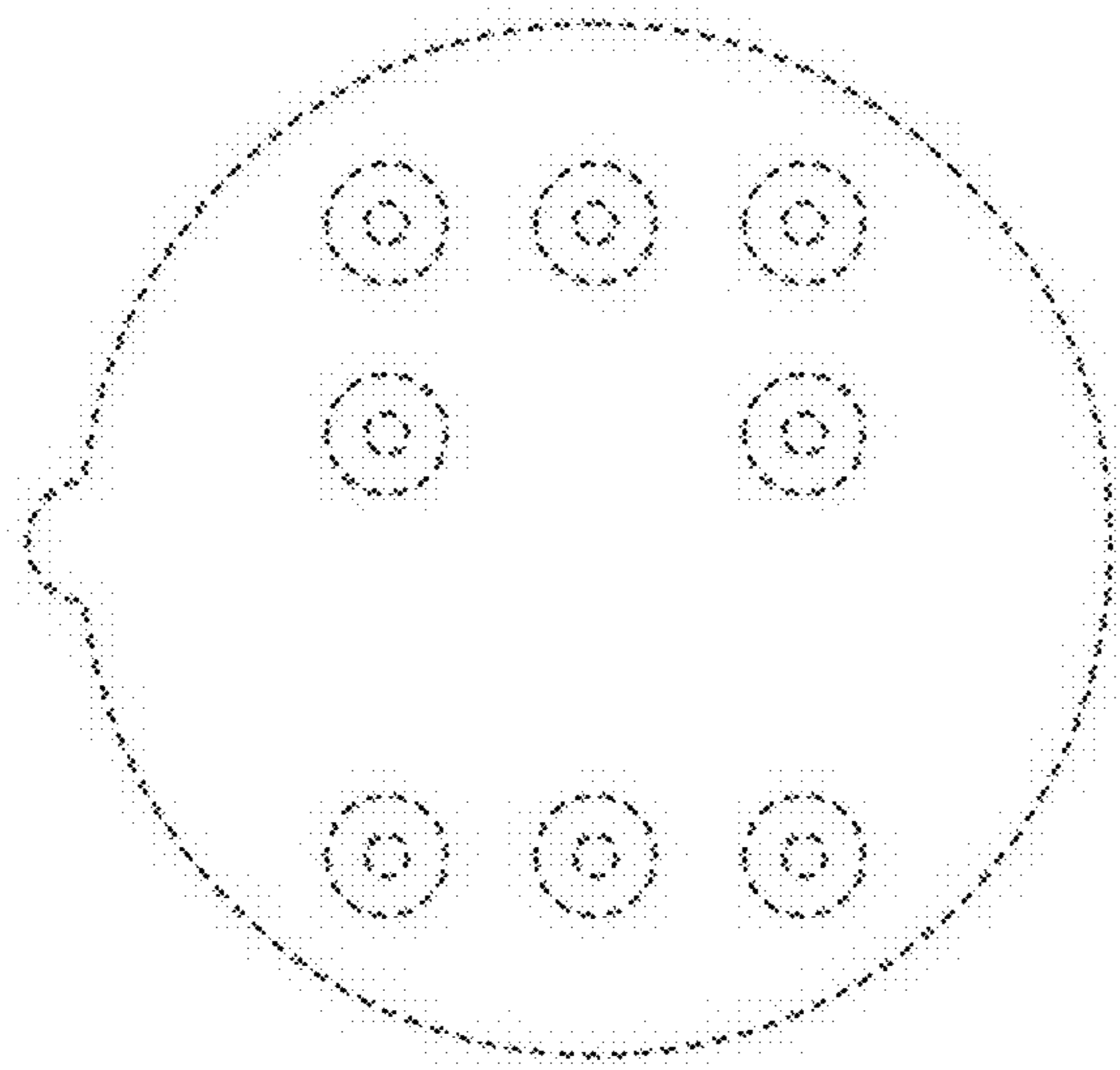

1.6

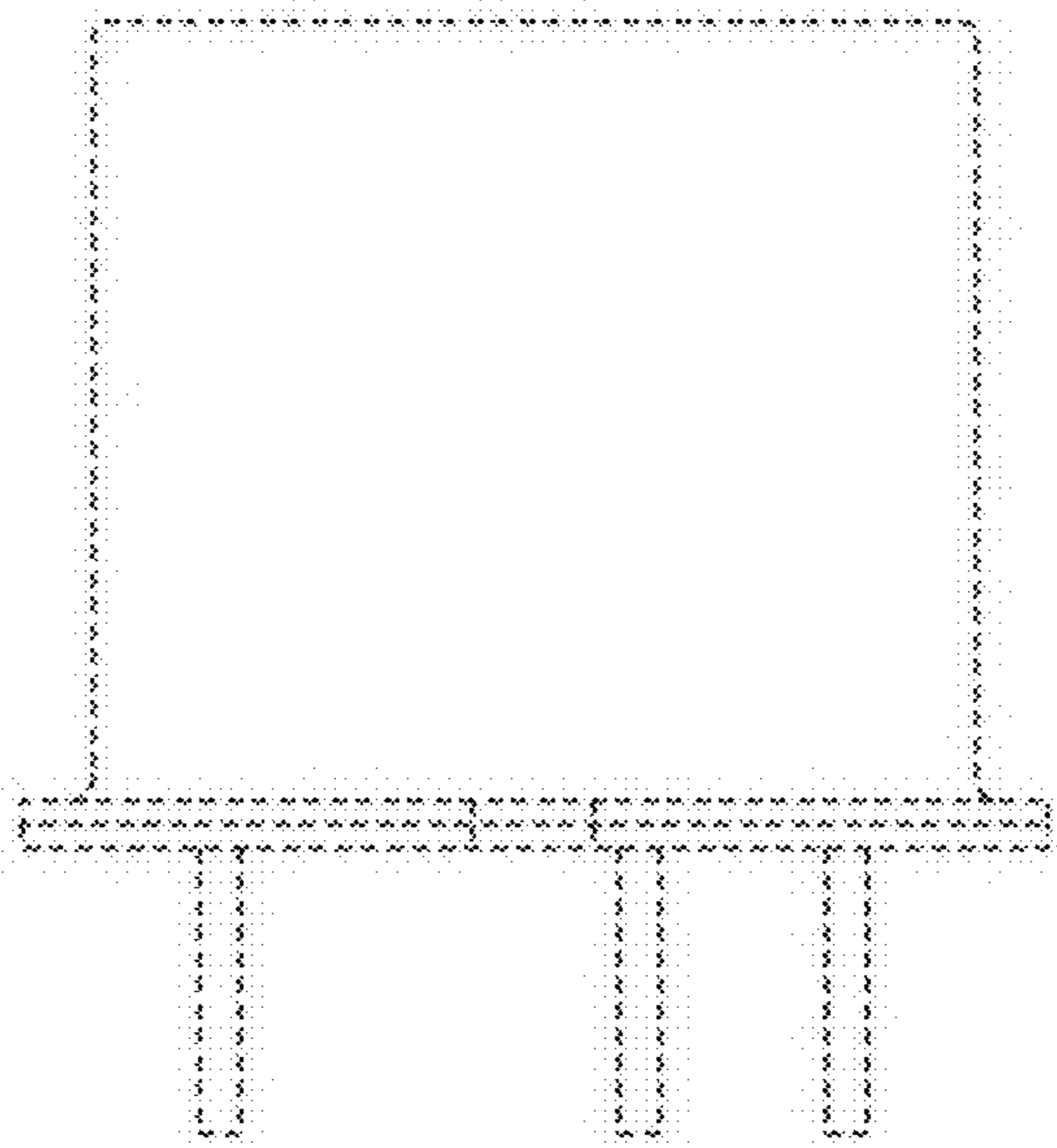

1.7

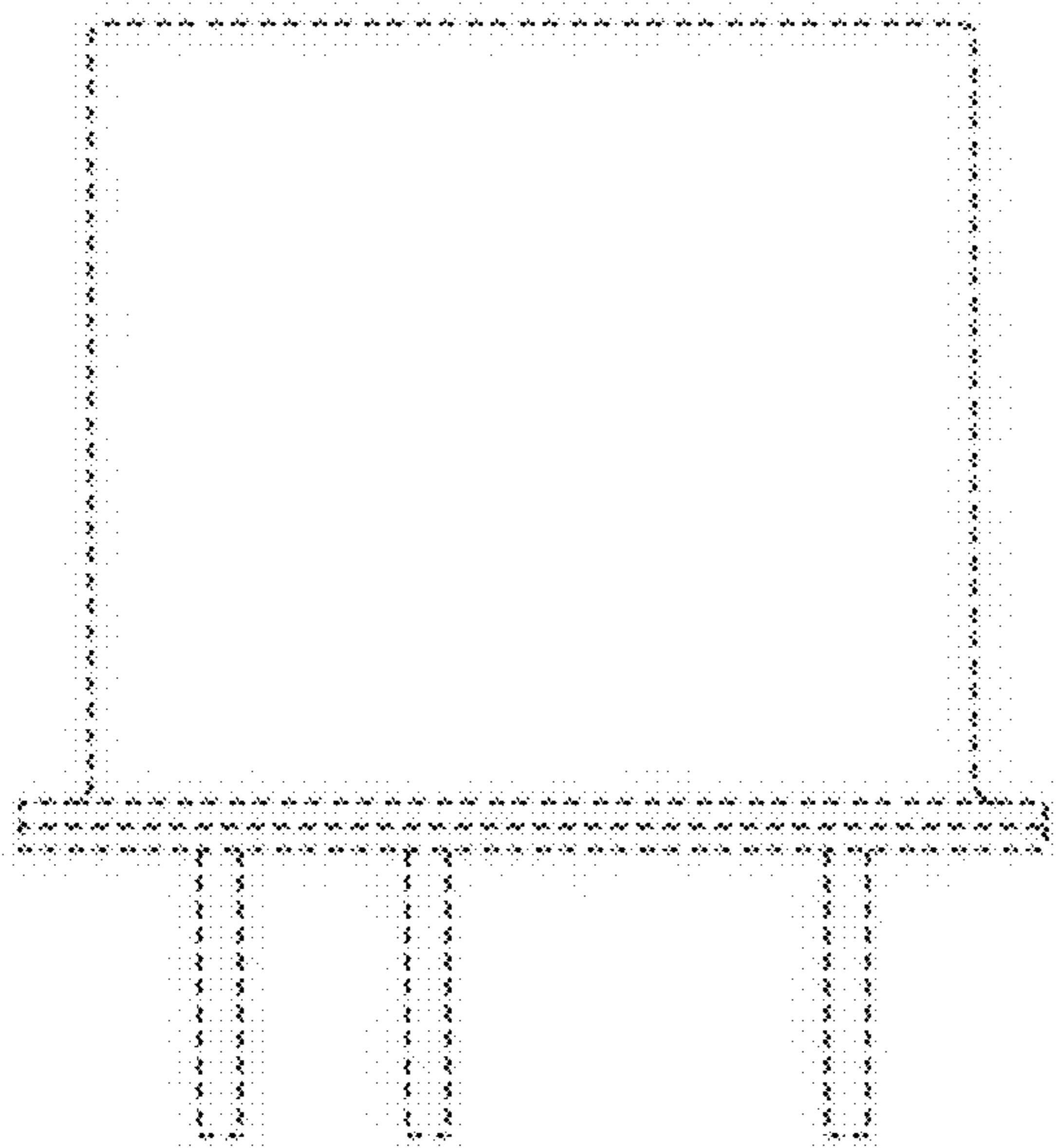

1.8

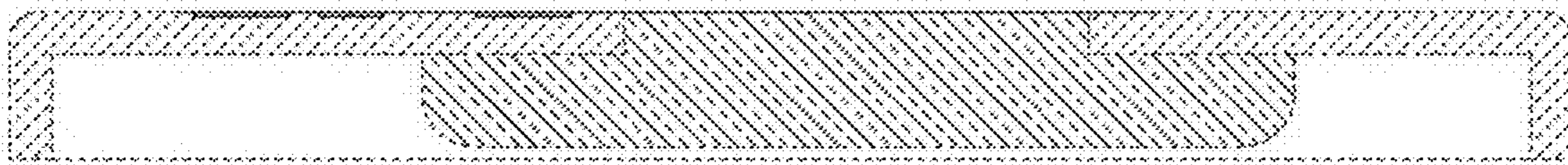

1.9

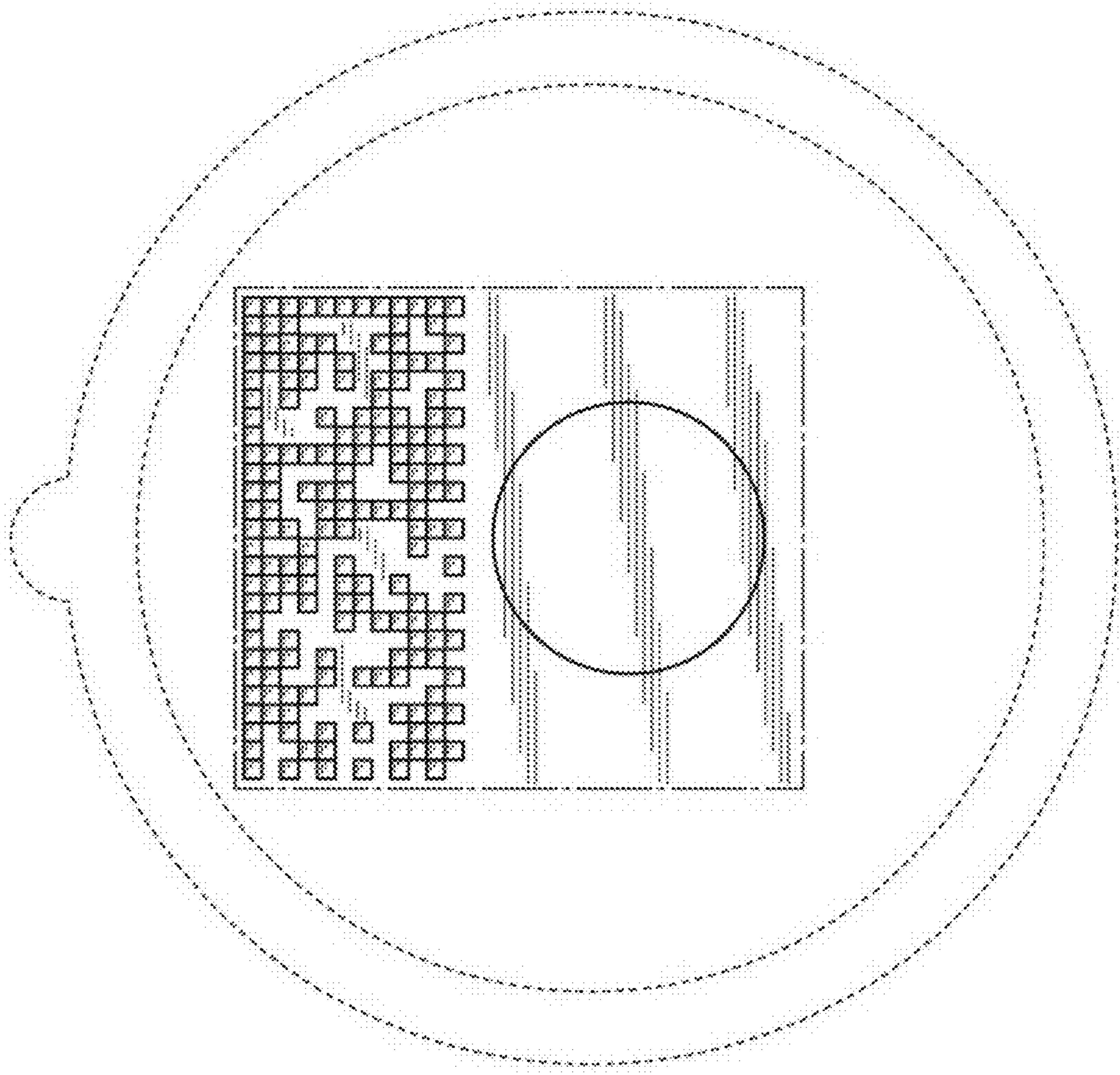

1.10

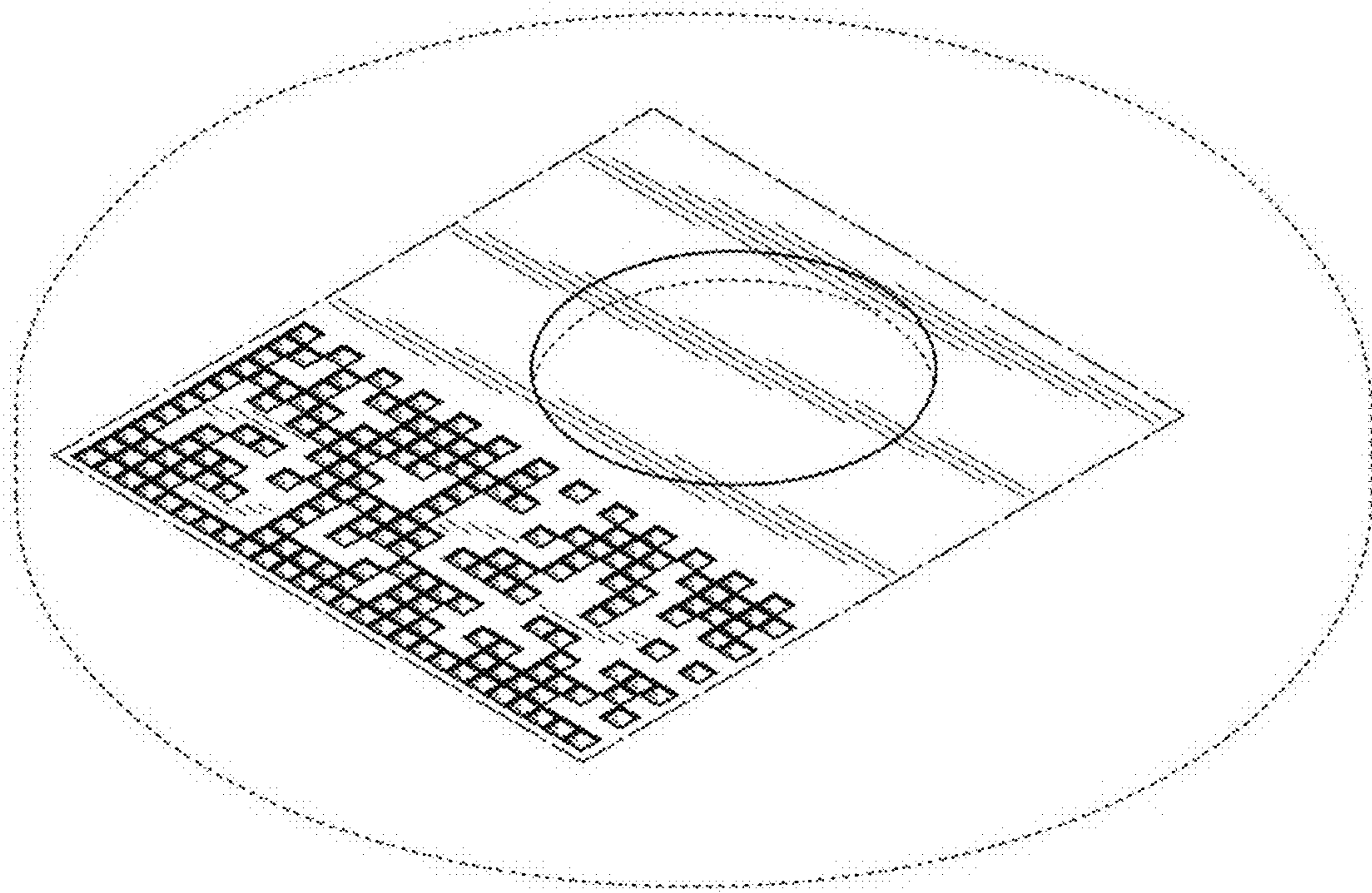

2.1

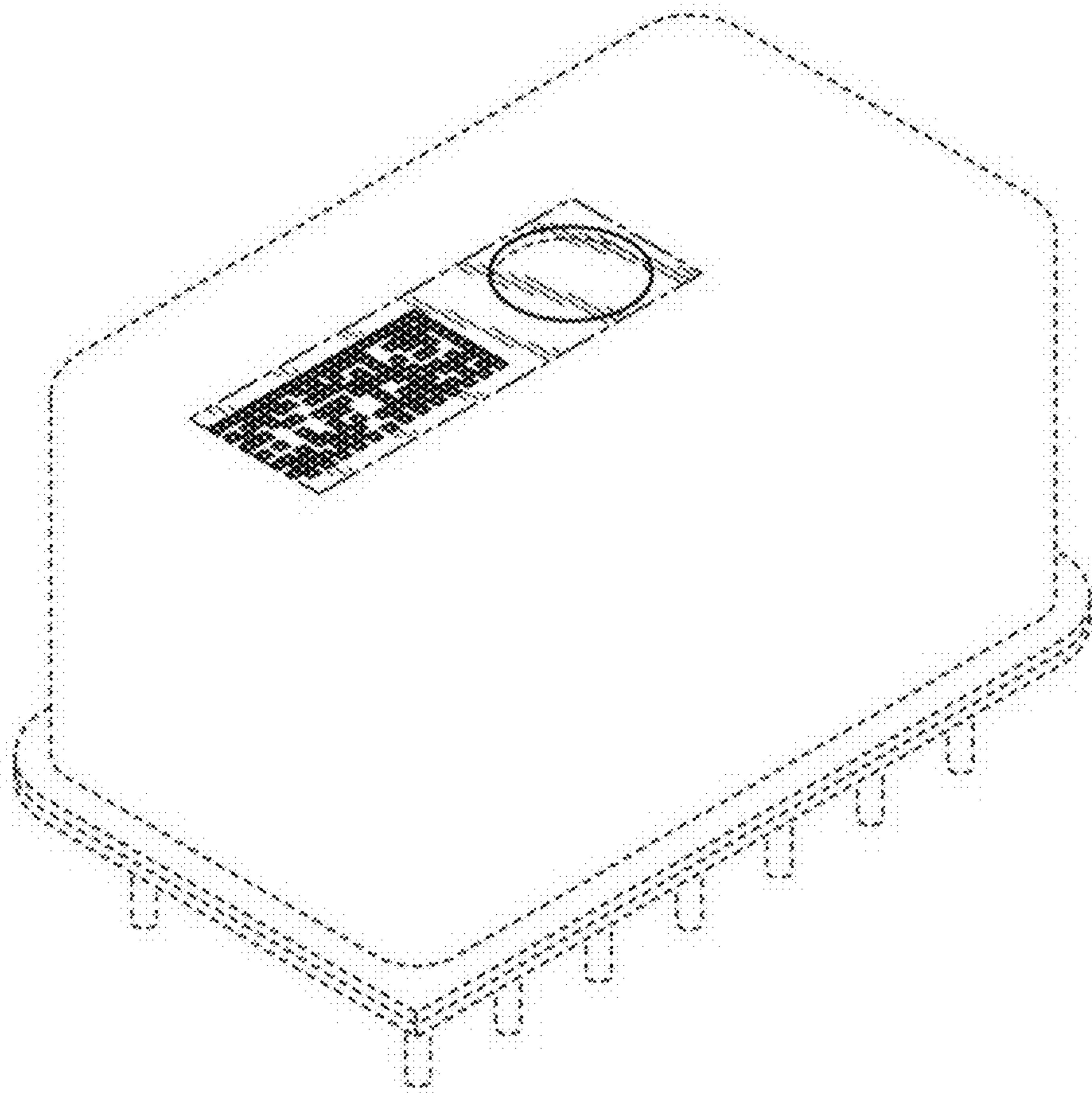

2.2

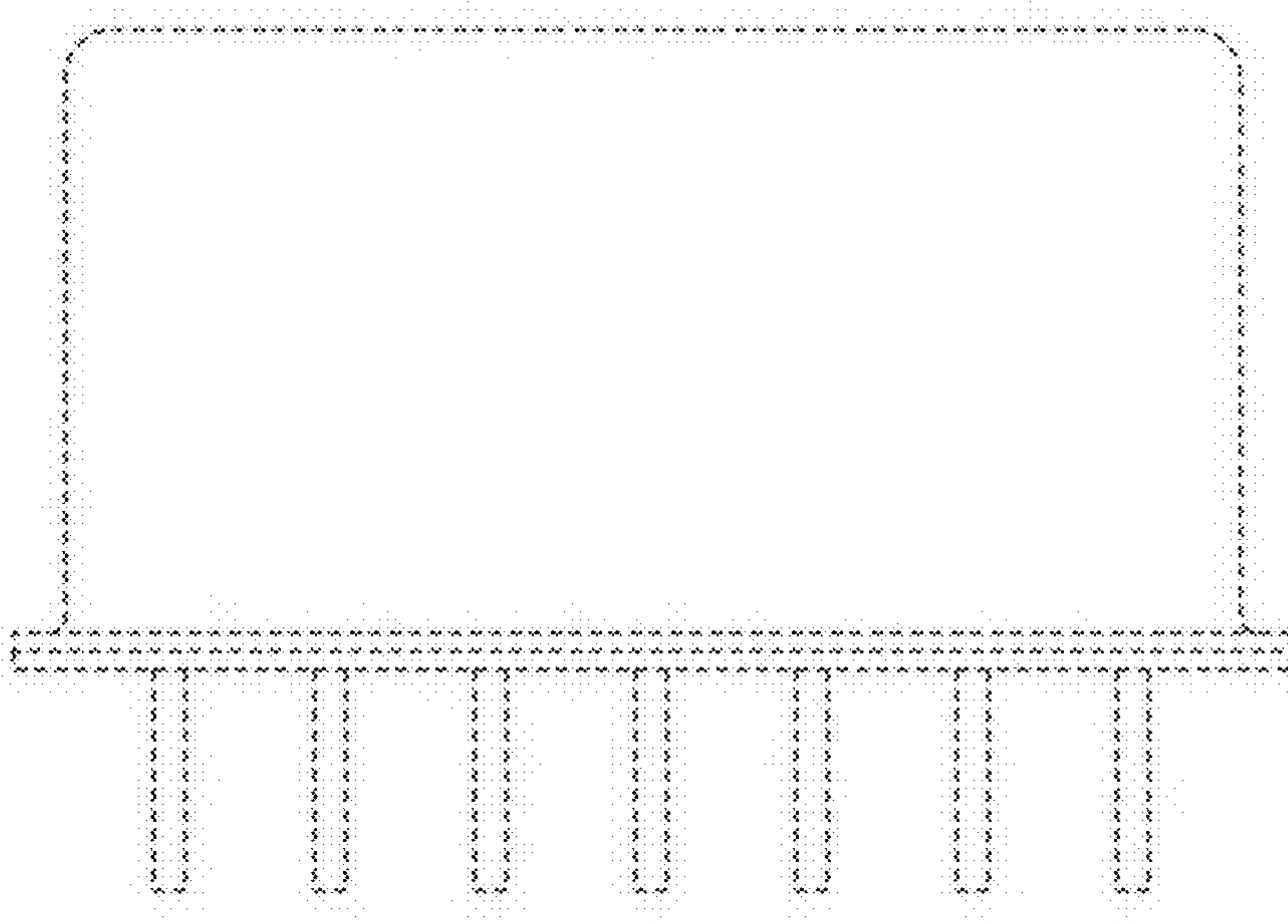

2.3

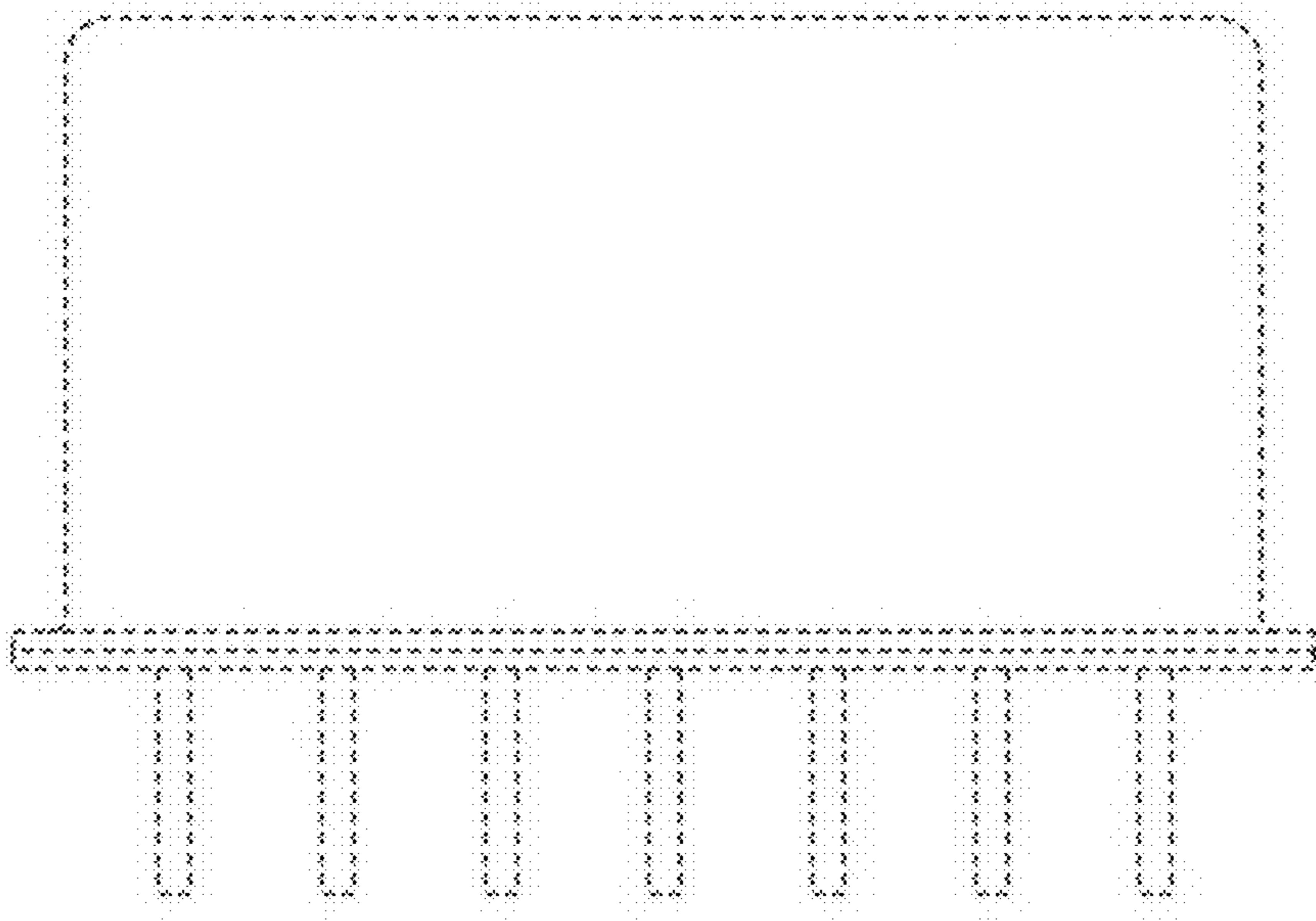

2.4

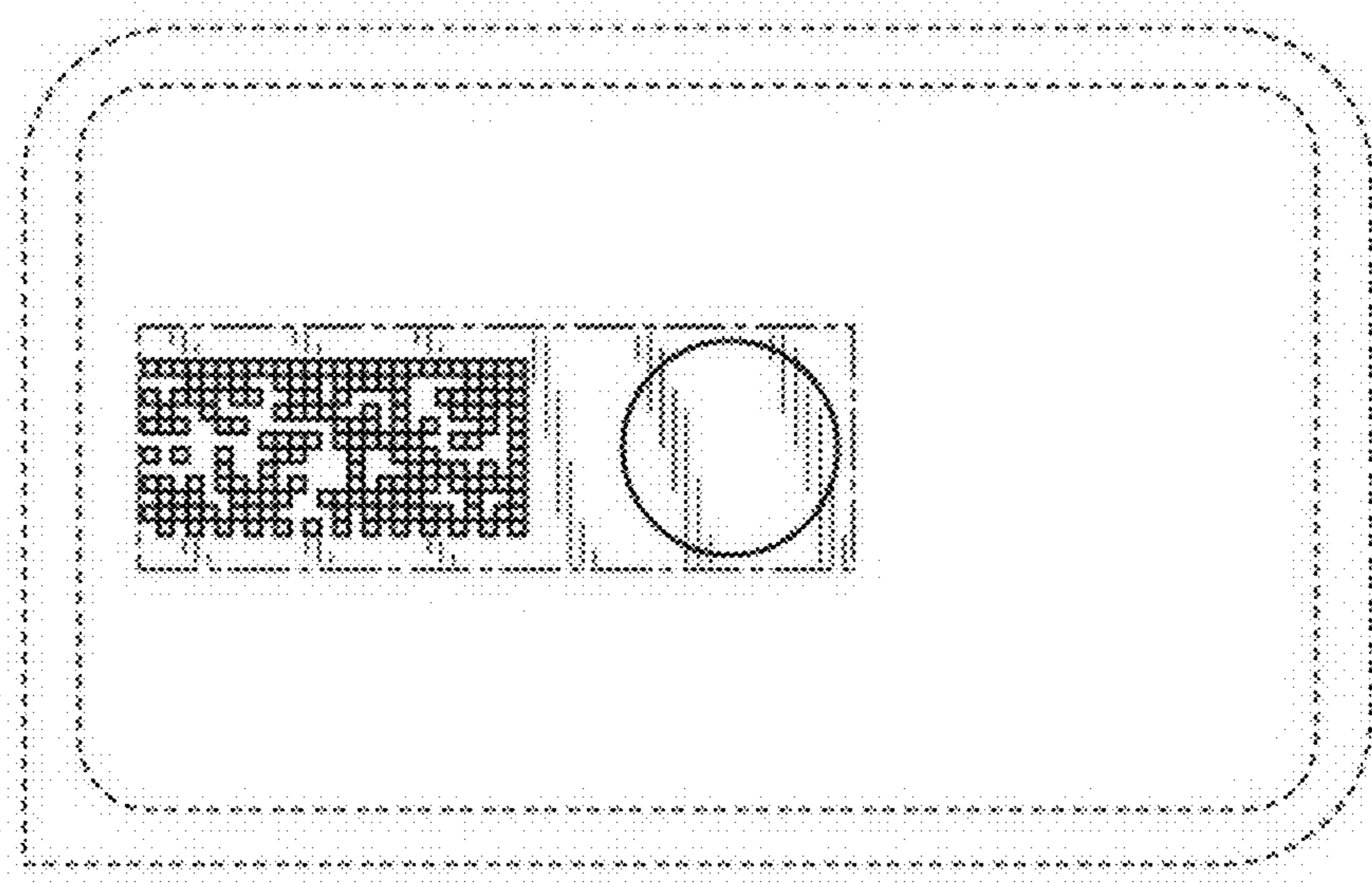

2.5

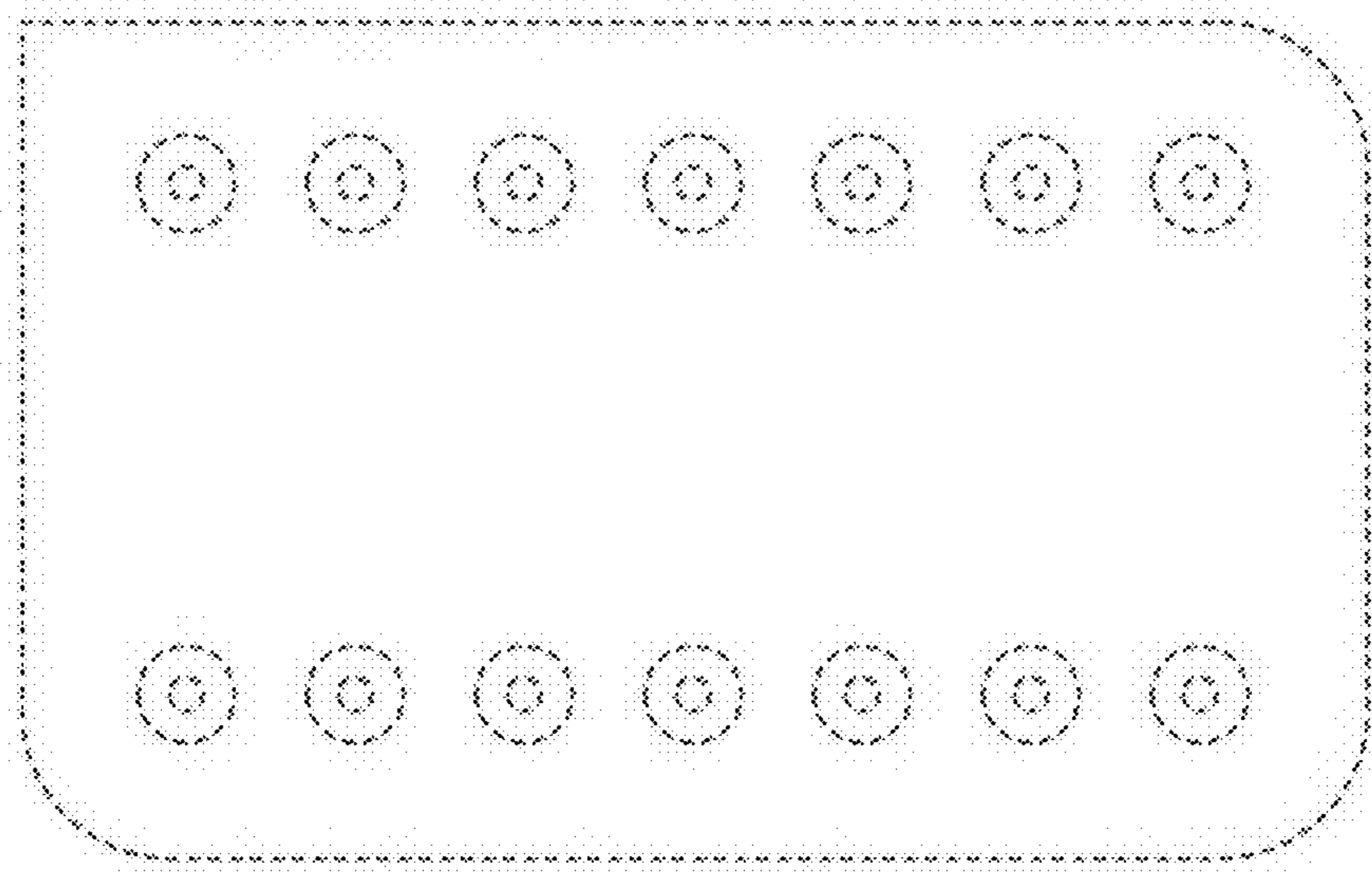

2.6

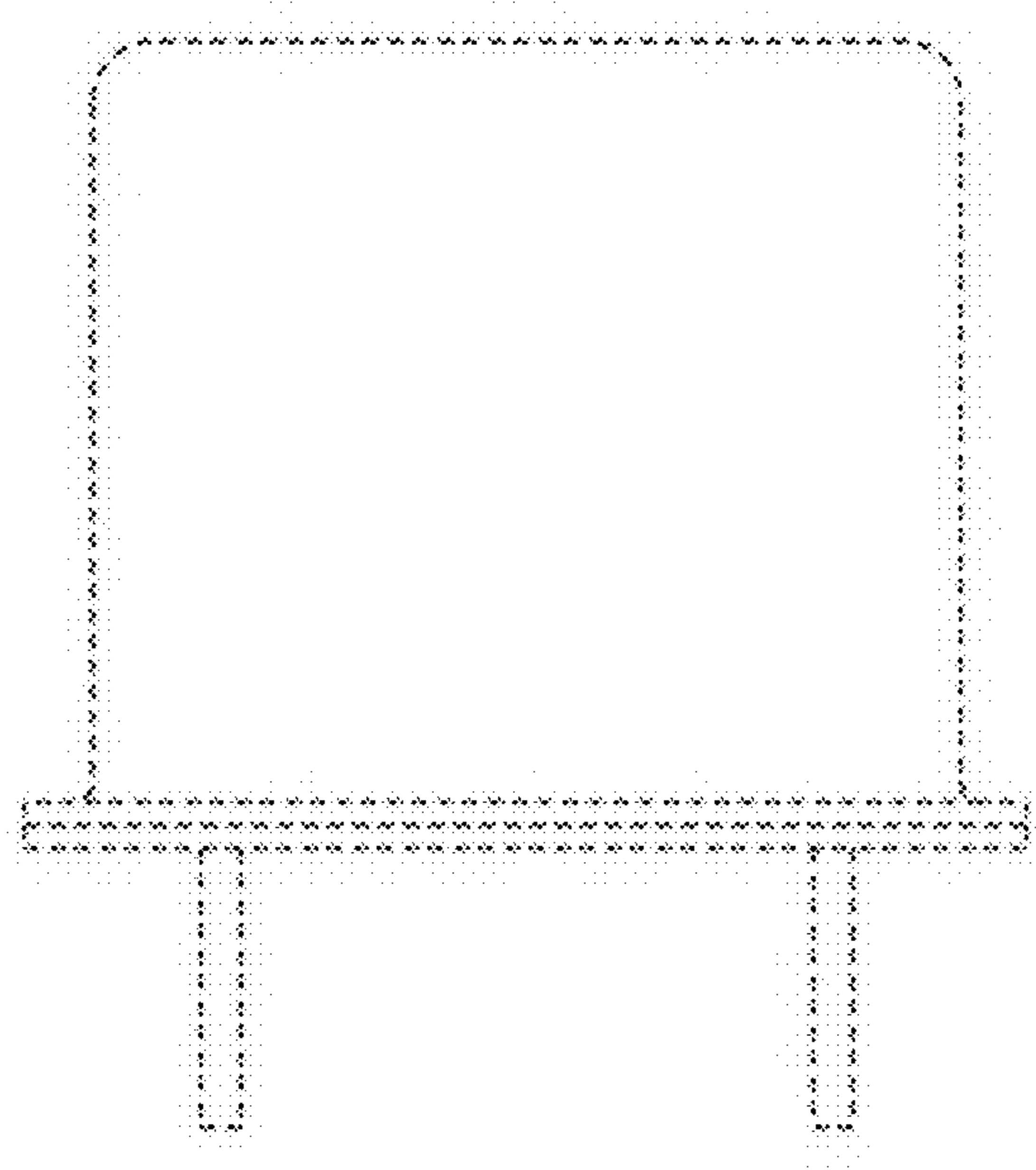

2.7

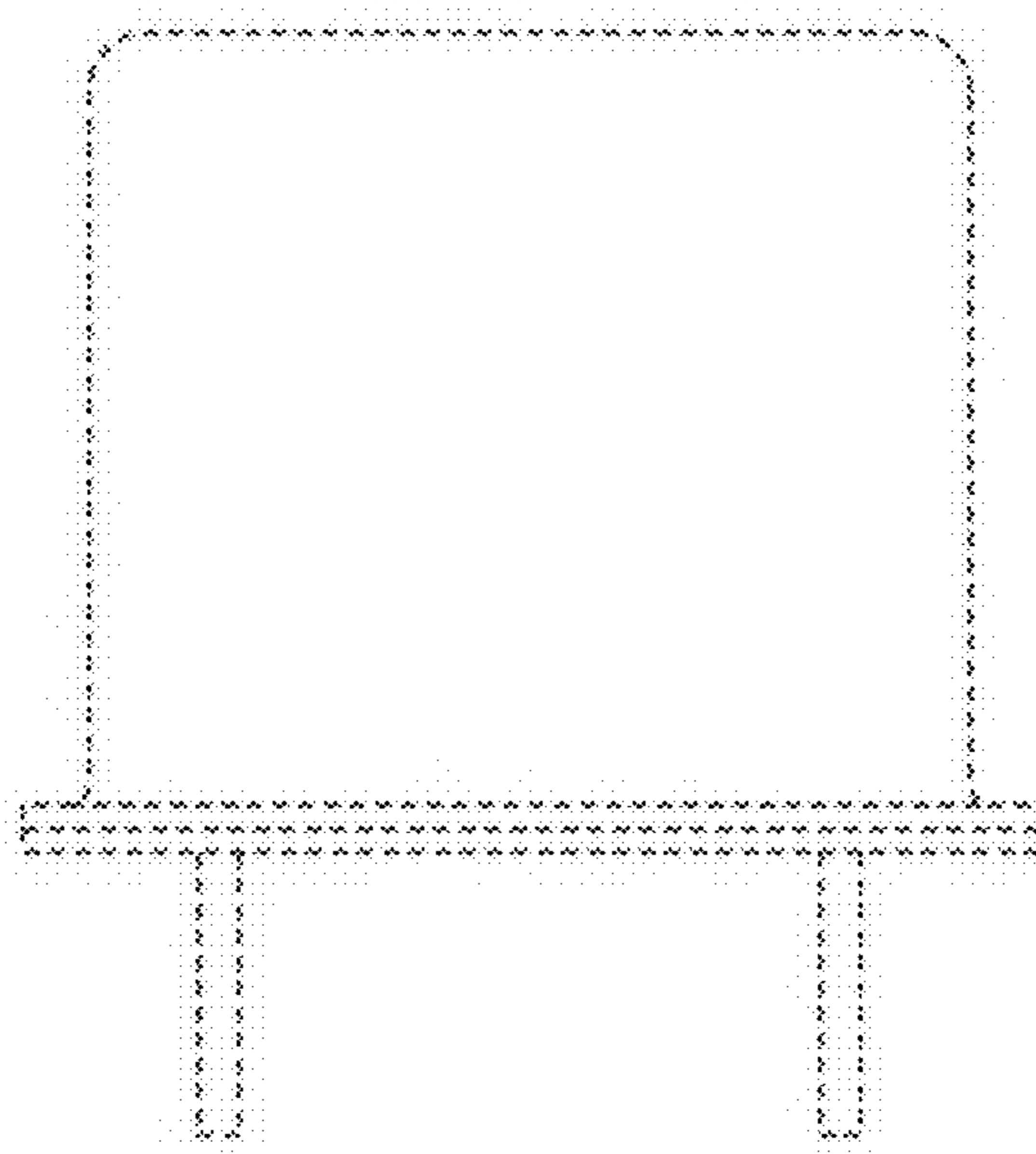

2.8

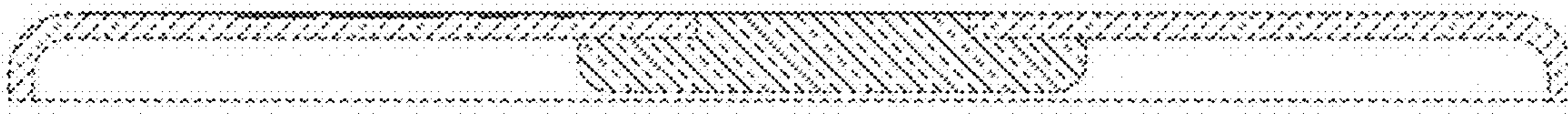

2.9

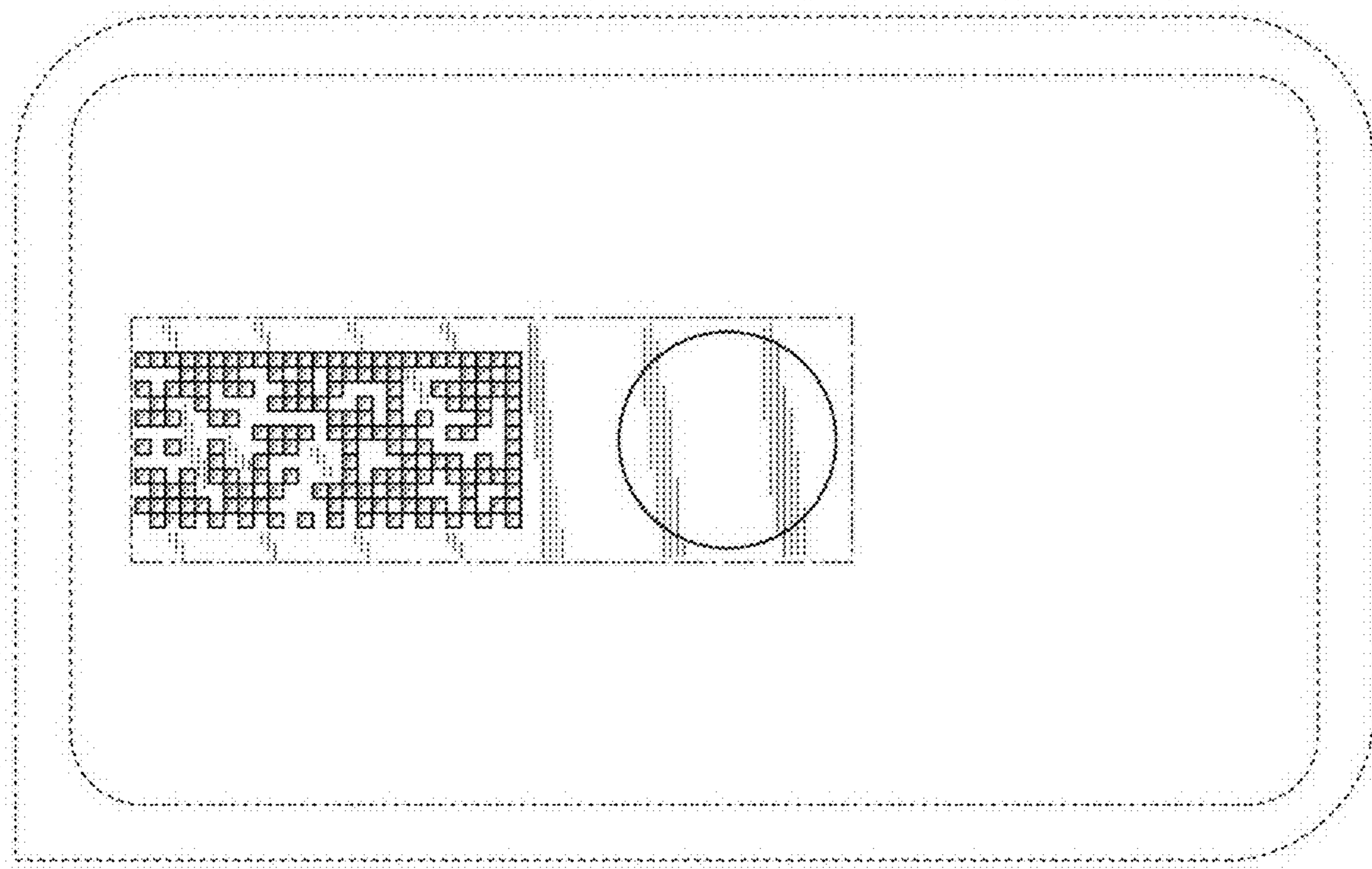

2.10

