



US00D825215S

(12) **United States Design Patent**
Olofsson et al.

(10) **Patent No.:** **US D825,215 S**
(45) **Date of Patent:** **** Aug. 14, 2018**

(54) **CHAIR**

(71) Applicant: **Vestre AS**, Oslo (NO)

(72) Inventors: **Michael Olofsson**, Oslo (NO); **Tore Borgersen**, Oslo (NO); **Espen Voll**, Oslo (NO)

(73) Assignee: **Vestre AS**, Oslo (NO)

(**) Term: **15 Years**

(21) Appl. No.: **29/592,984**

(22) Filed: **Feb. 3, 2017**

(51) **LOC (11) Cl.** **06-01**

(52) **U.S. Cl.**
USPC **D6/373**; D6/370

(58) **Field of Classification Search**
USPC D6/334-336, 370, 371, 372, 373, 374,
D6/376, 379, 380, 716, 716.1, 716.4
CPC A47C 3/04; A47C 4/02; A47C 4/03; A47C
4/08; A47C 5/04; A47C 5/06; A47C
4/022; A47C 7/16
See application file for complete search history.

(56) **References Cited**

U.S. PATENT DOCUMENTS

D90,912 S *	10/1933	Goodman	D6/373
D157,447 S *	2/1950	Smith	D6/373
D166,660 S *	5/1952	Curtis	D6/373
2,955,646 A *	10/1960	Briggs	A47C 5/06 297/440.21
3,999,802 A *	12/1976	Powers	A47C 3/04 297/239
D296,961 S *	8/1988	Norton	D6/370
D779,219 S *	2/2017	Miller	D6/373

* cited by examiner

Primary Examiner — Mimosa De

(74) *Attorney, Agent, or Firm* — Kolisich Hartwell, P.C.

(57) **CLAIM**

The ornamental design for a chair, as shown and described.

DESCRIPTION

FIG. 1 is an upper, front, and left side perspective view of a chair showing my new design;
 FIG. 2 is an upper, rear, and left side perspective view thereof;
 FIG. 3 is a front elevational view thereof;
 FIG. 4 is a rear elevational view thereof;
 FIG. 5 is a top plan view thereof;
 FIG. 6 is a bottom plan view thereof;
 FIG. 7 is a left side elevational view thereof;
 FIG. 8 is an alternative upper, front, and left side perspective view of a chair showing my new design;
 FIG. 9 is an upper, rear, and left side perspective view thereof;
 FIG. 10 is a front elevational view thereof;
 FIG. 11 is a rear elevational view thereof;
 FIG. 12 is a top plan view thereof;
 FIG. 13 is a bottom plan view thereof; and,
 FIG. 14 is a left side elevational view thereof.
 The dashed lines shown in the drawings are included for purposes of illustrating environmental structure. The dashed lines and structure they depict form no part of the claimed design. The right side of the chair is a mirror image of the left side, so the right side view has been omitted.

1 Claim, 14 Drawing Sheets

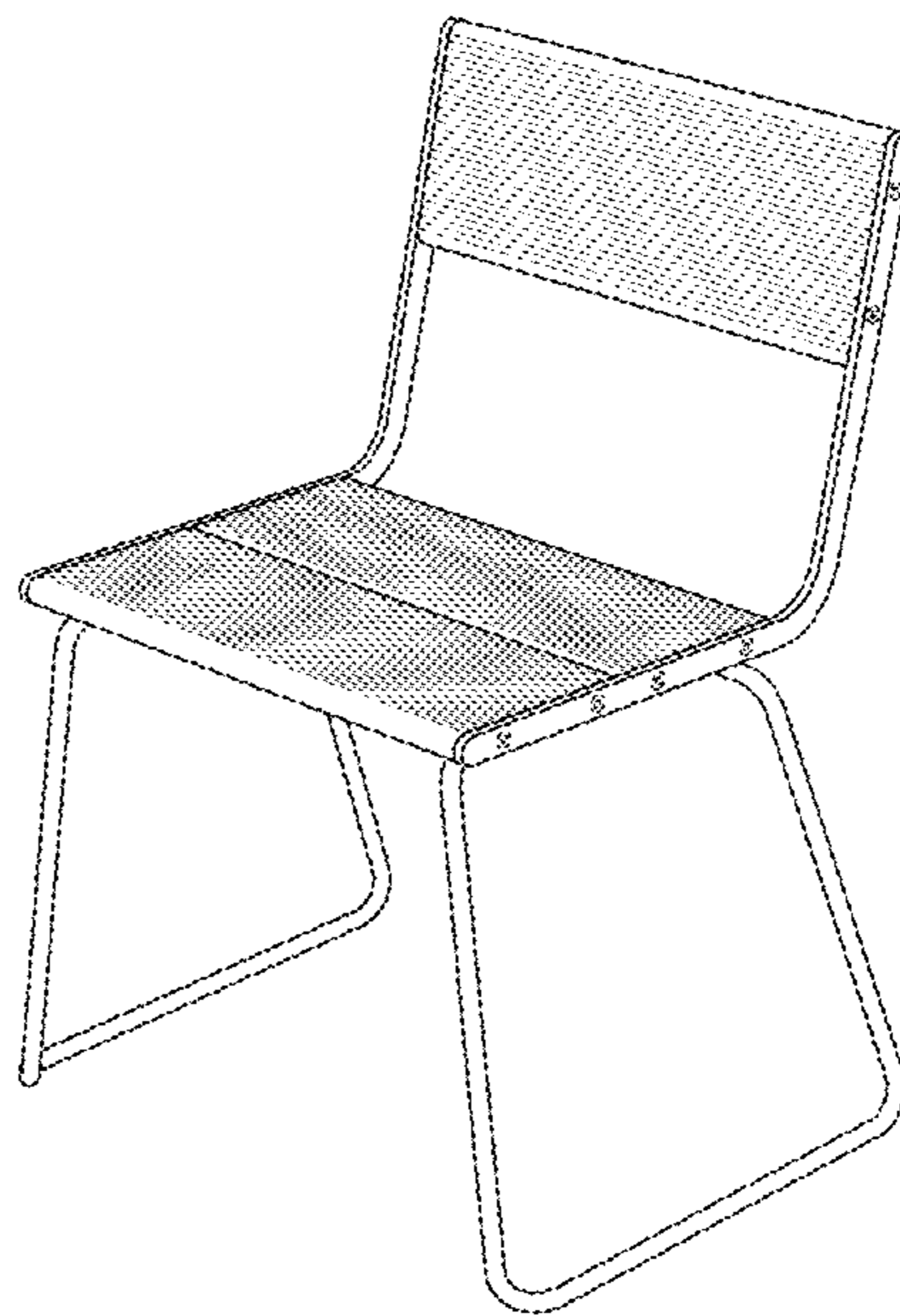
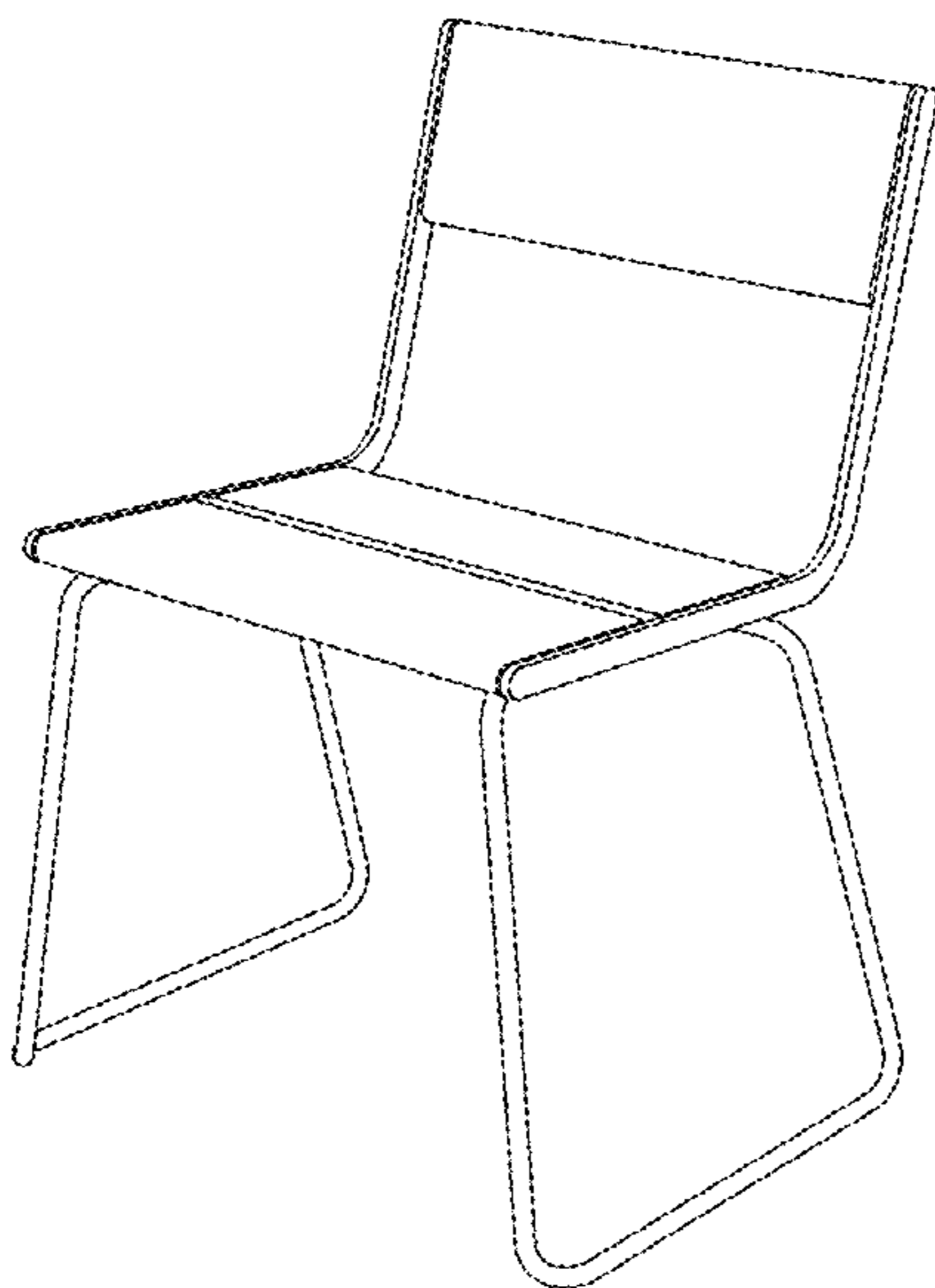

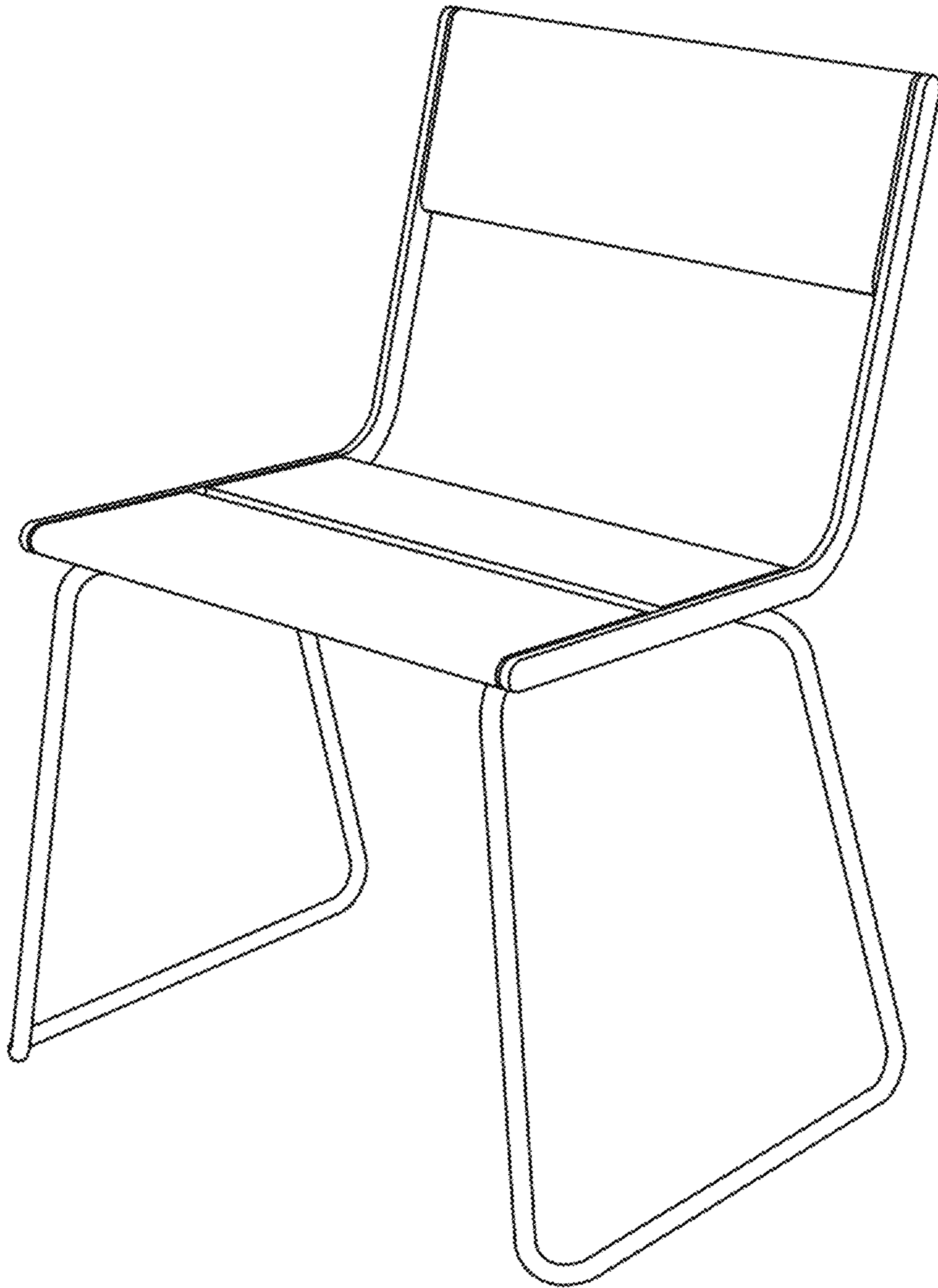

Fig. 1

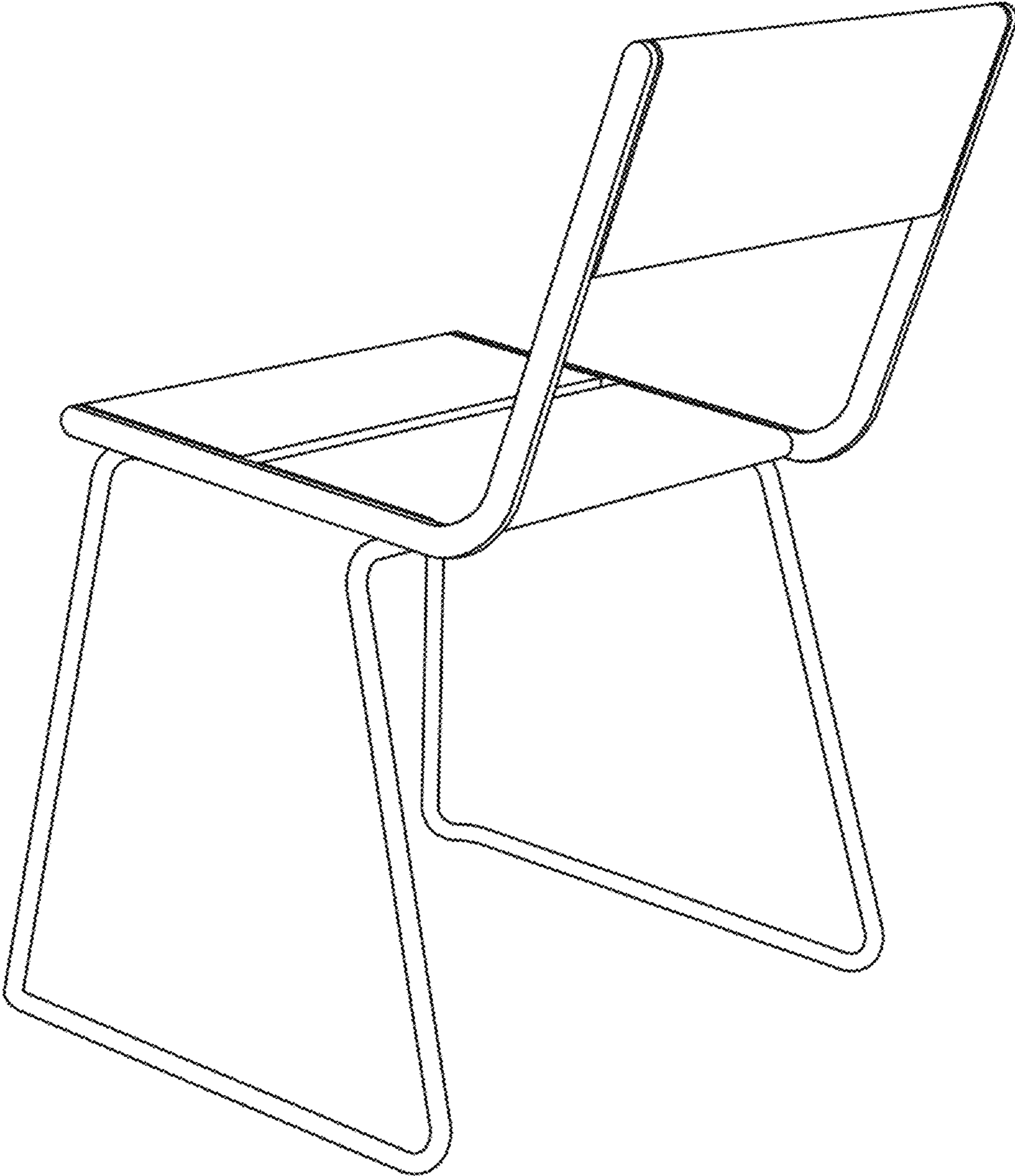

Fig. 2

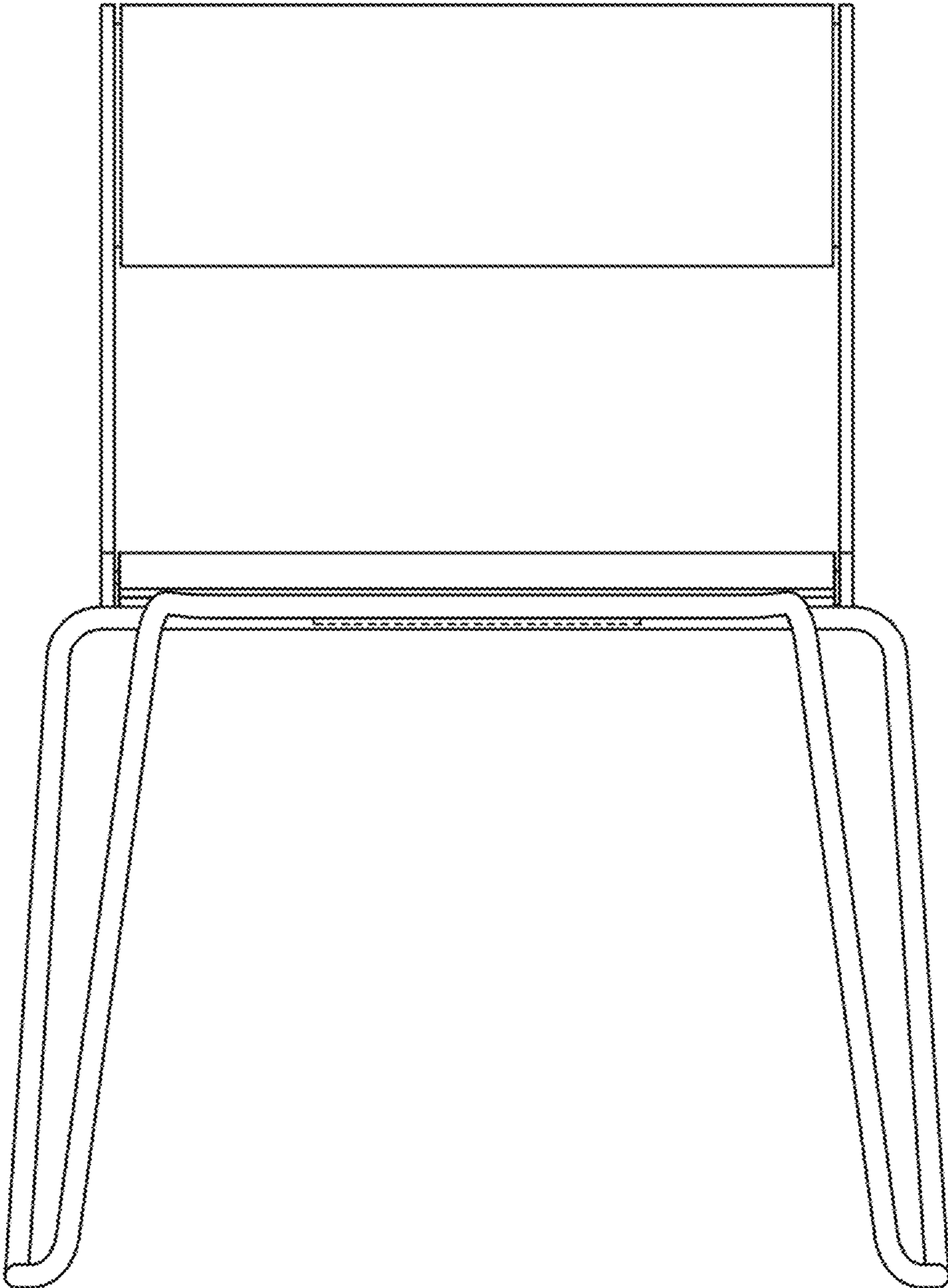

Fig. 3

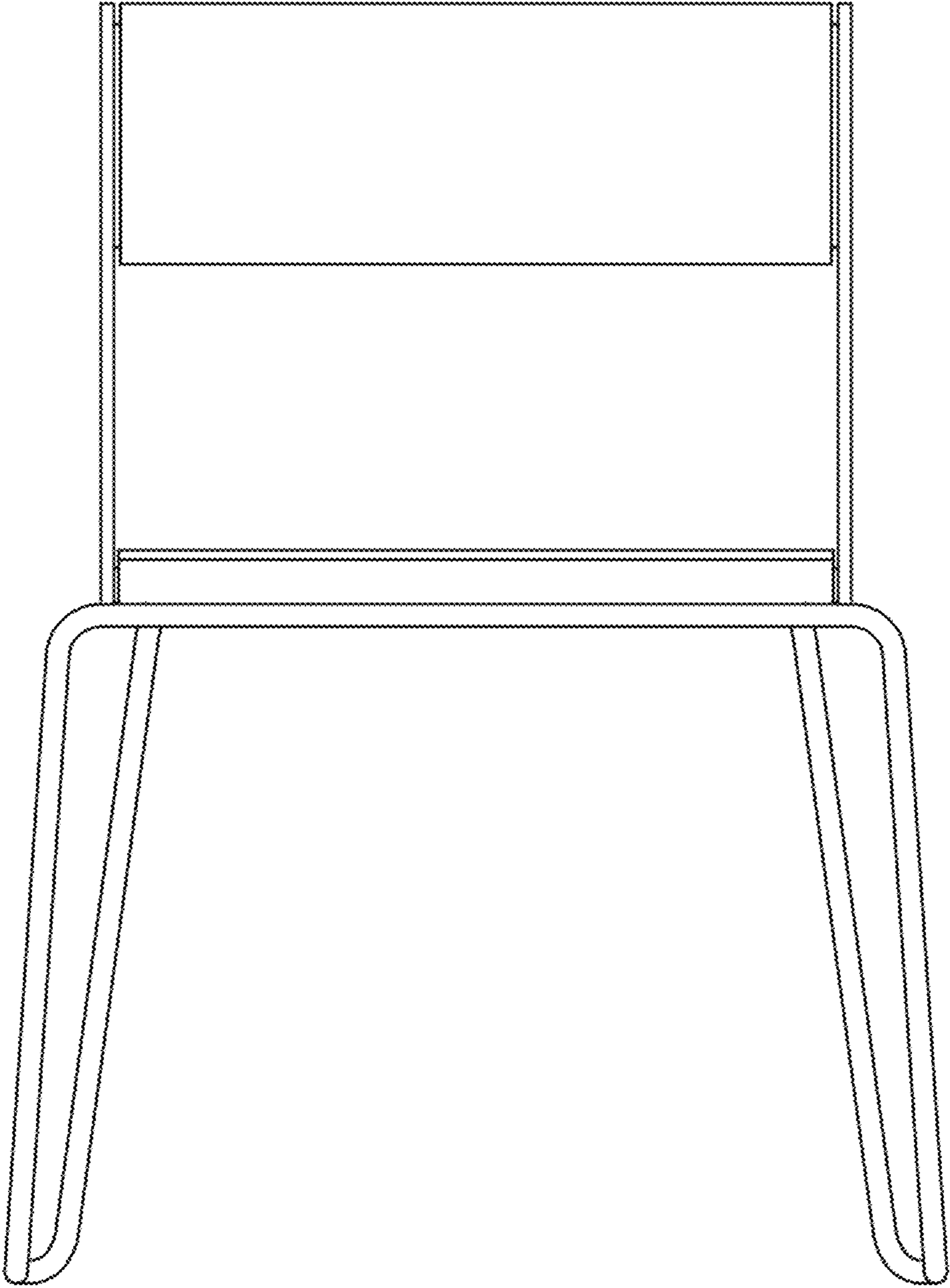

Fig. 4

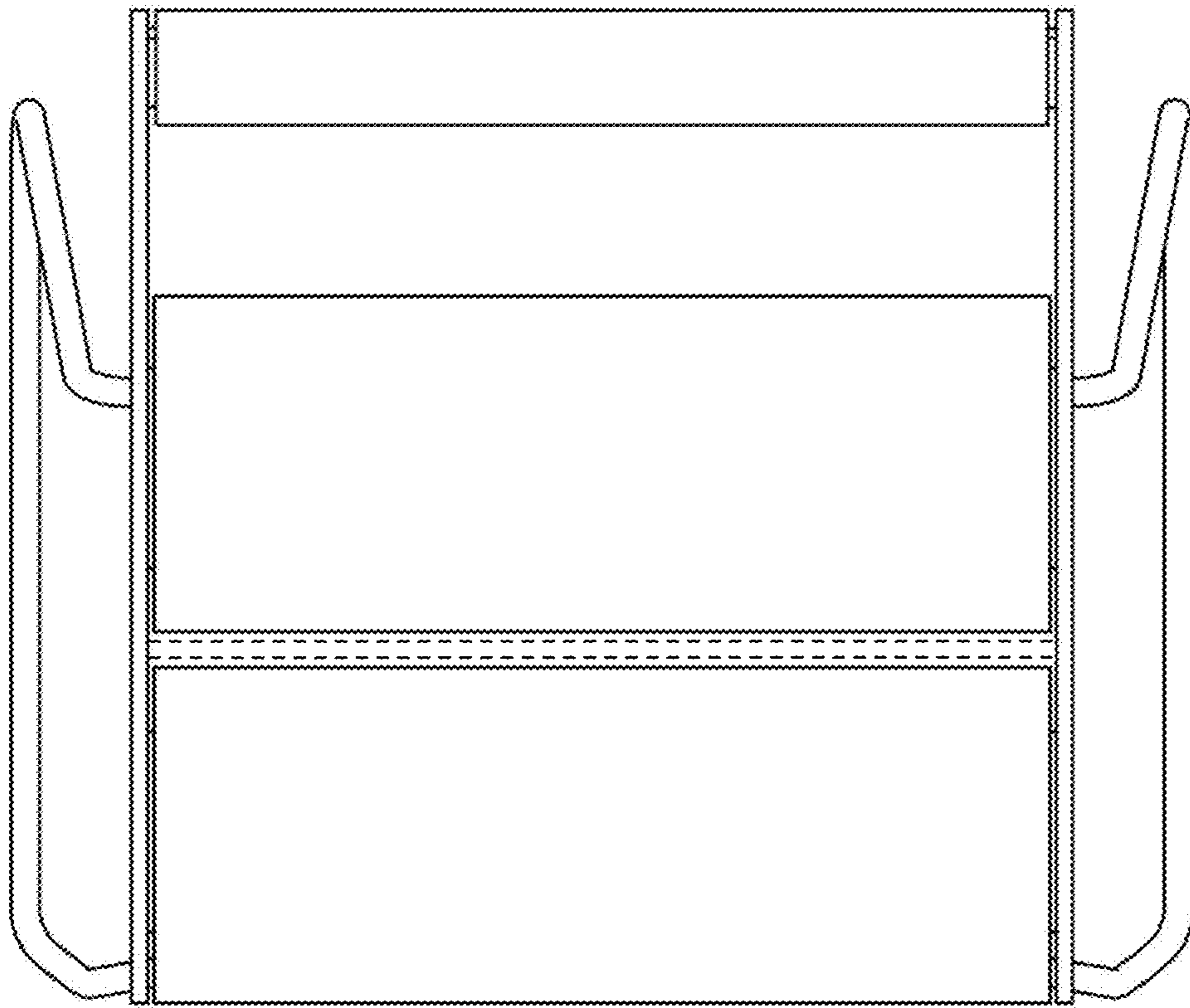

Fig. 5

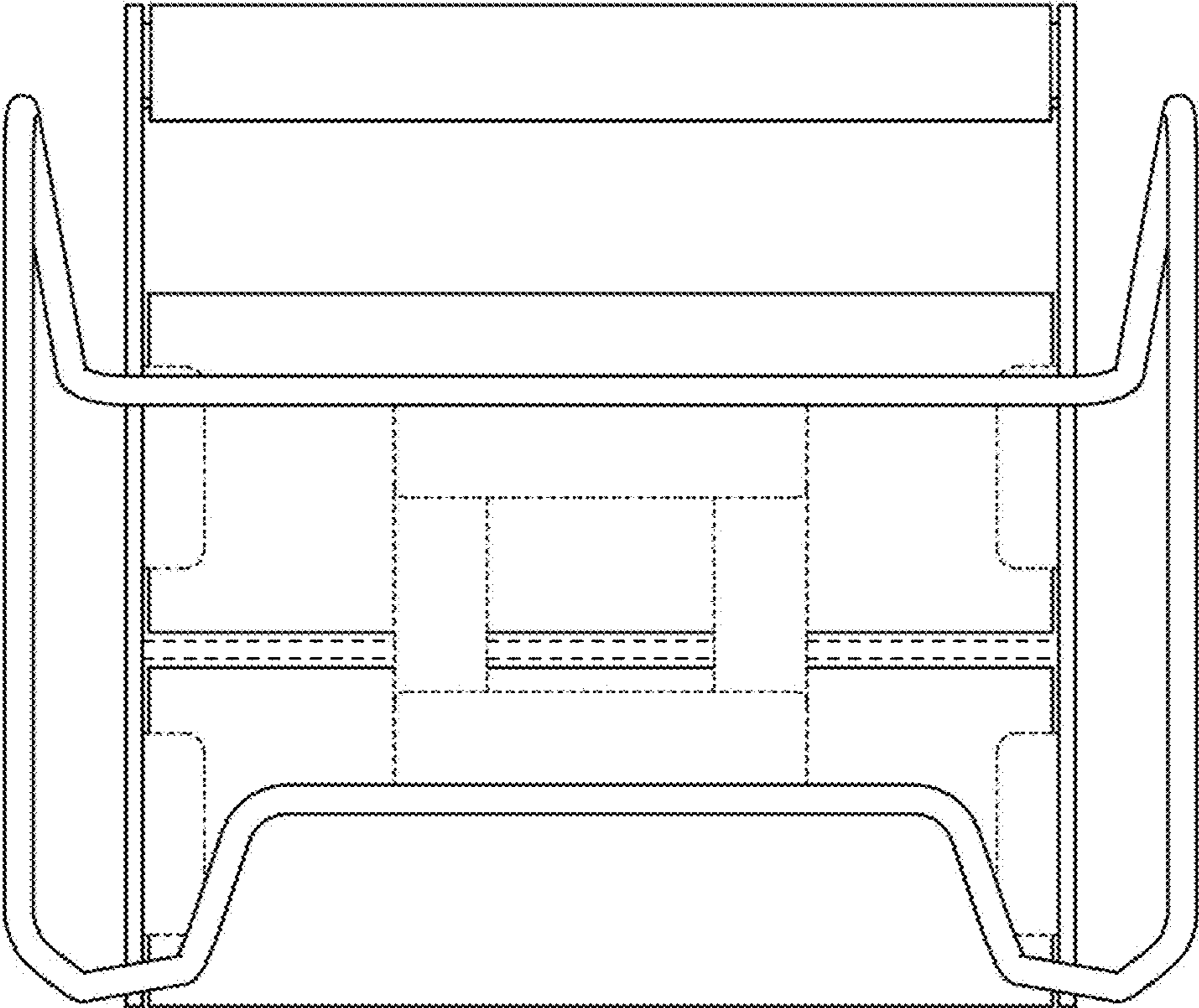

Fig. 6

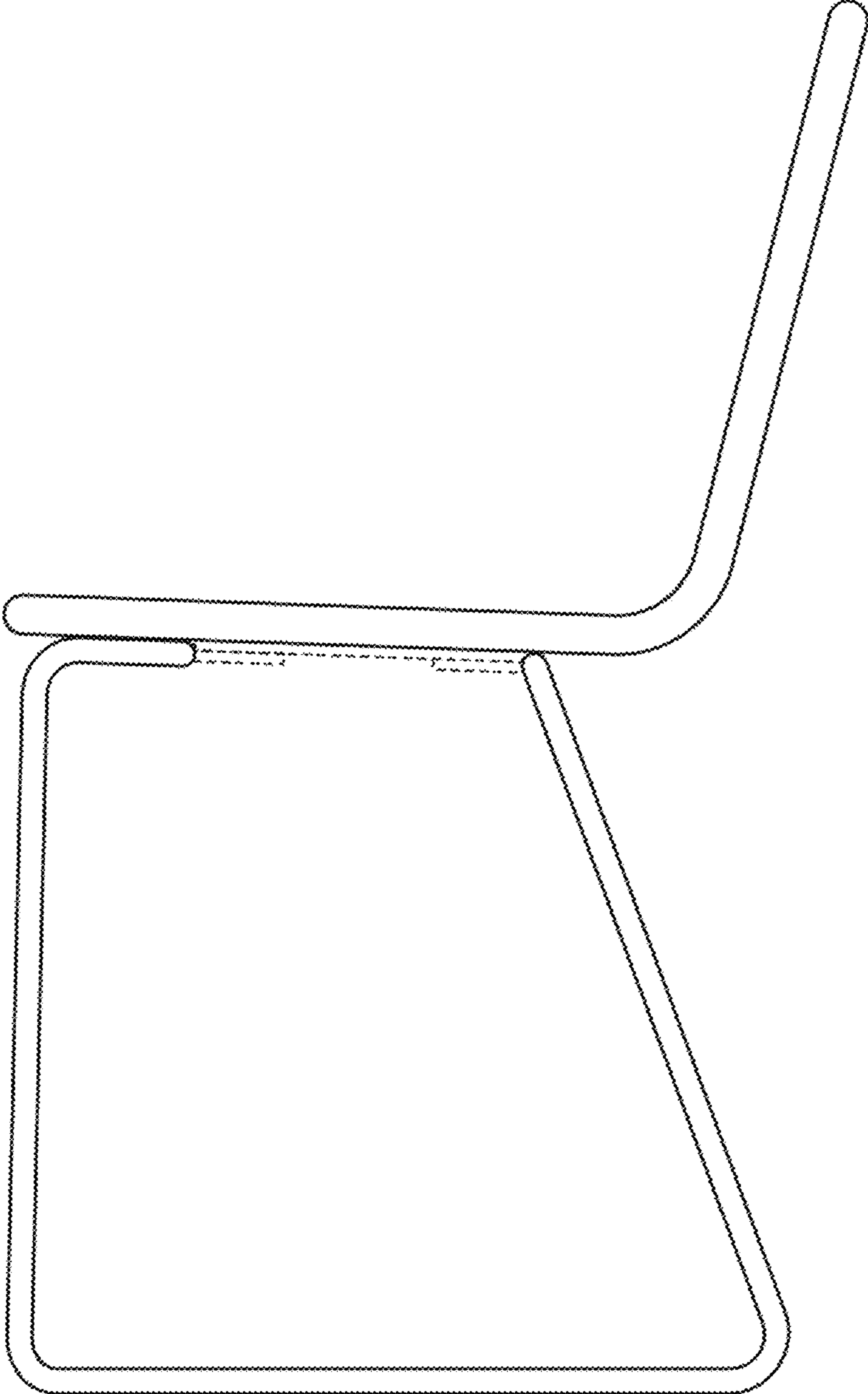

Fig. 7

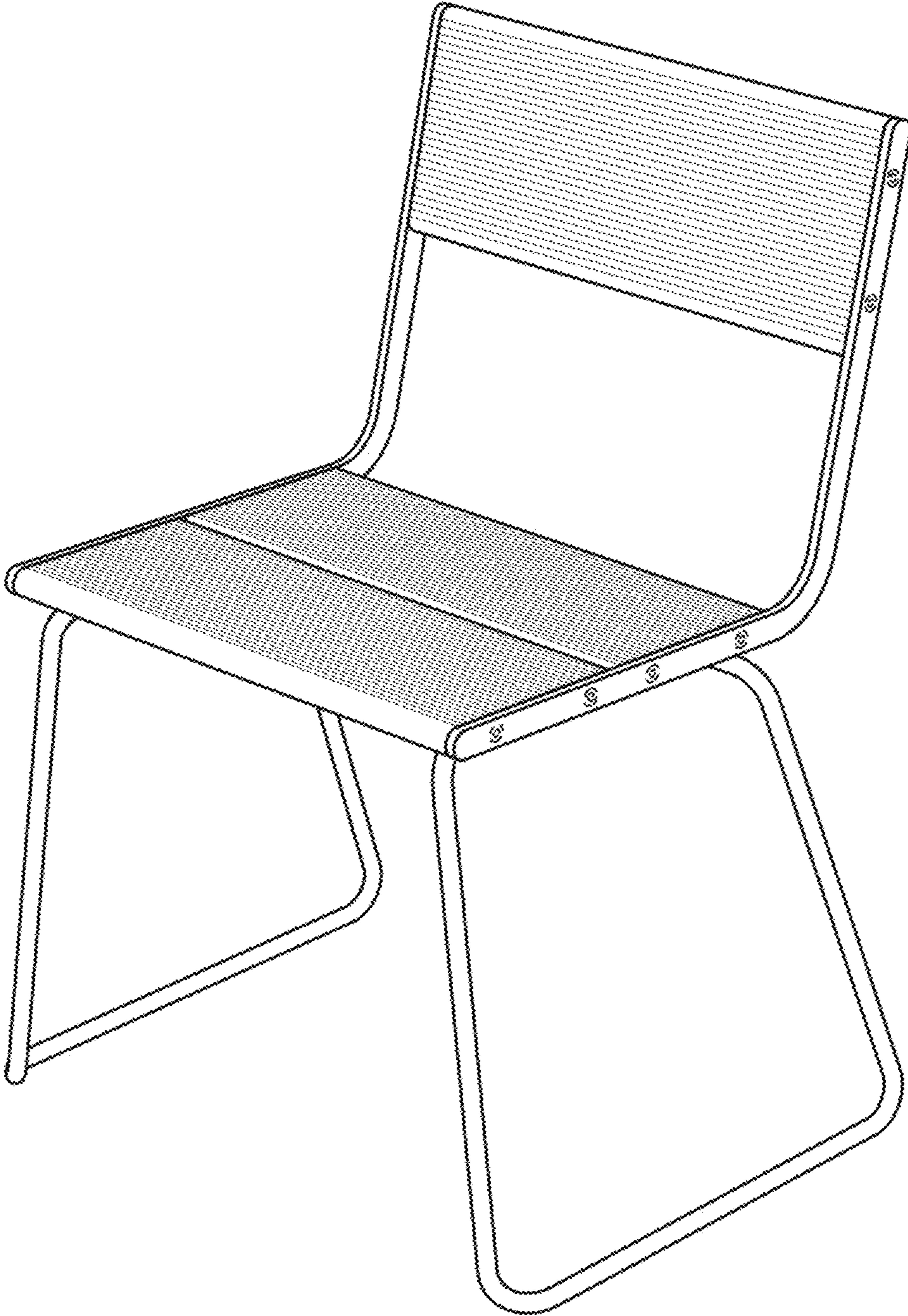

Fig. 8

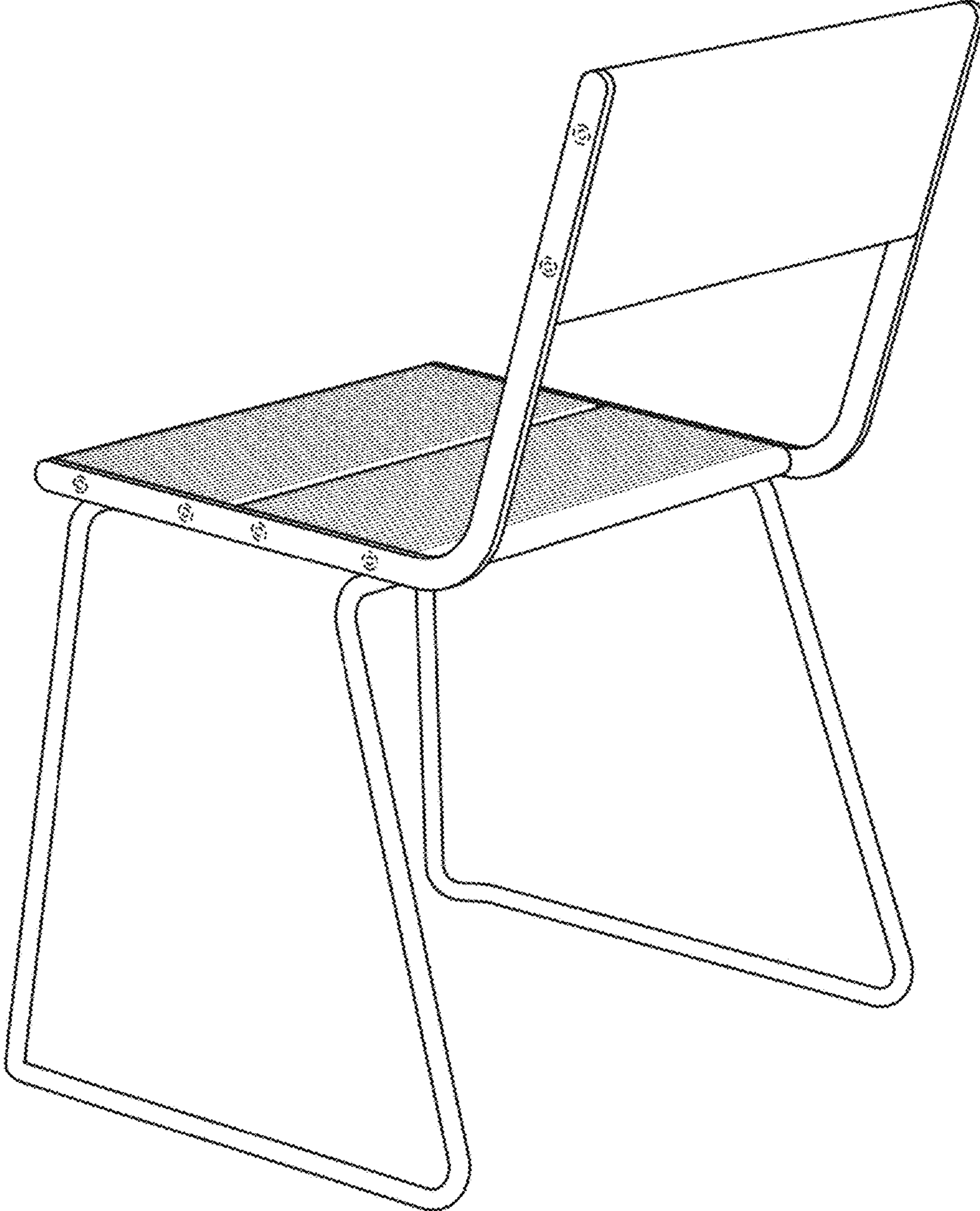

Fig. 9

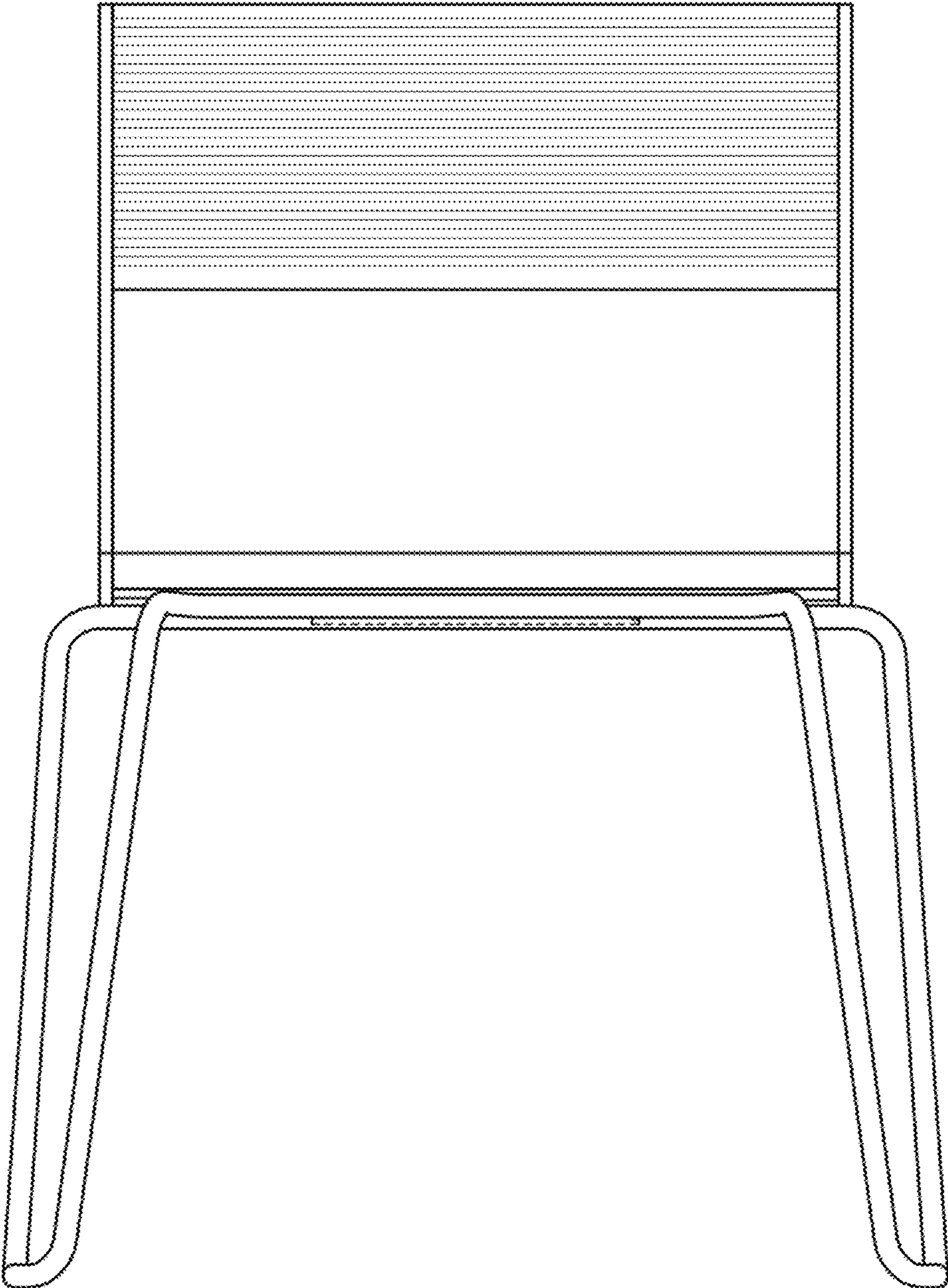

Fig. 10

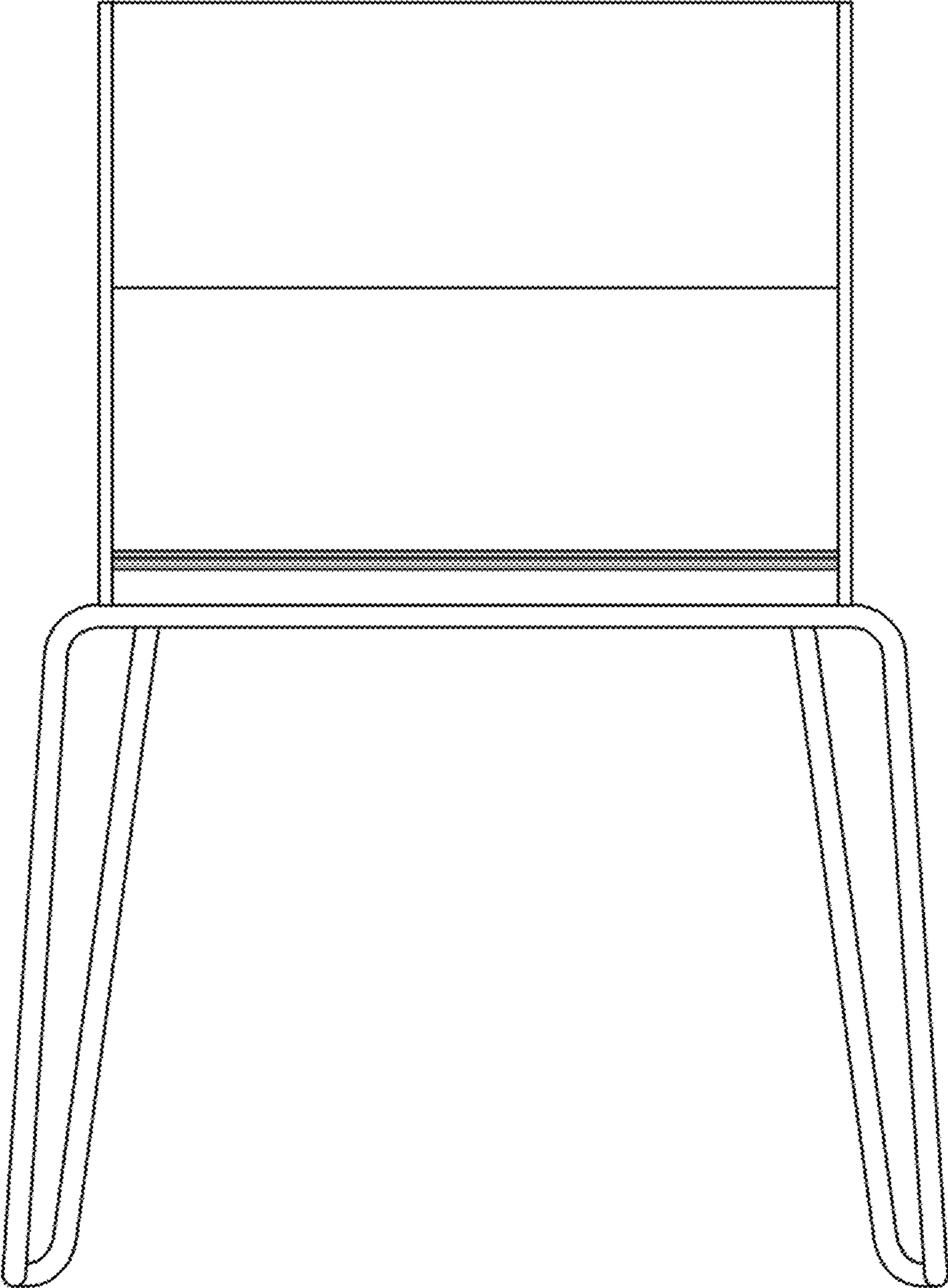

Fig. 11

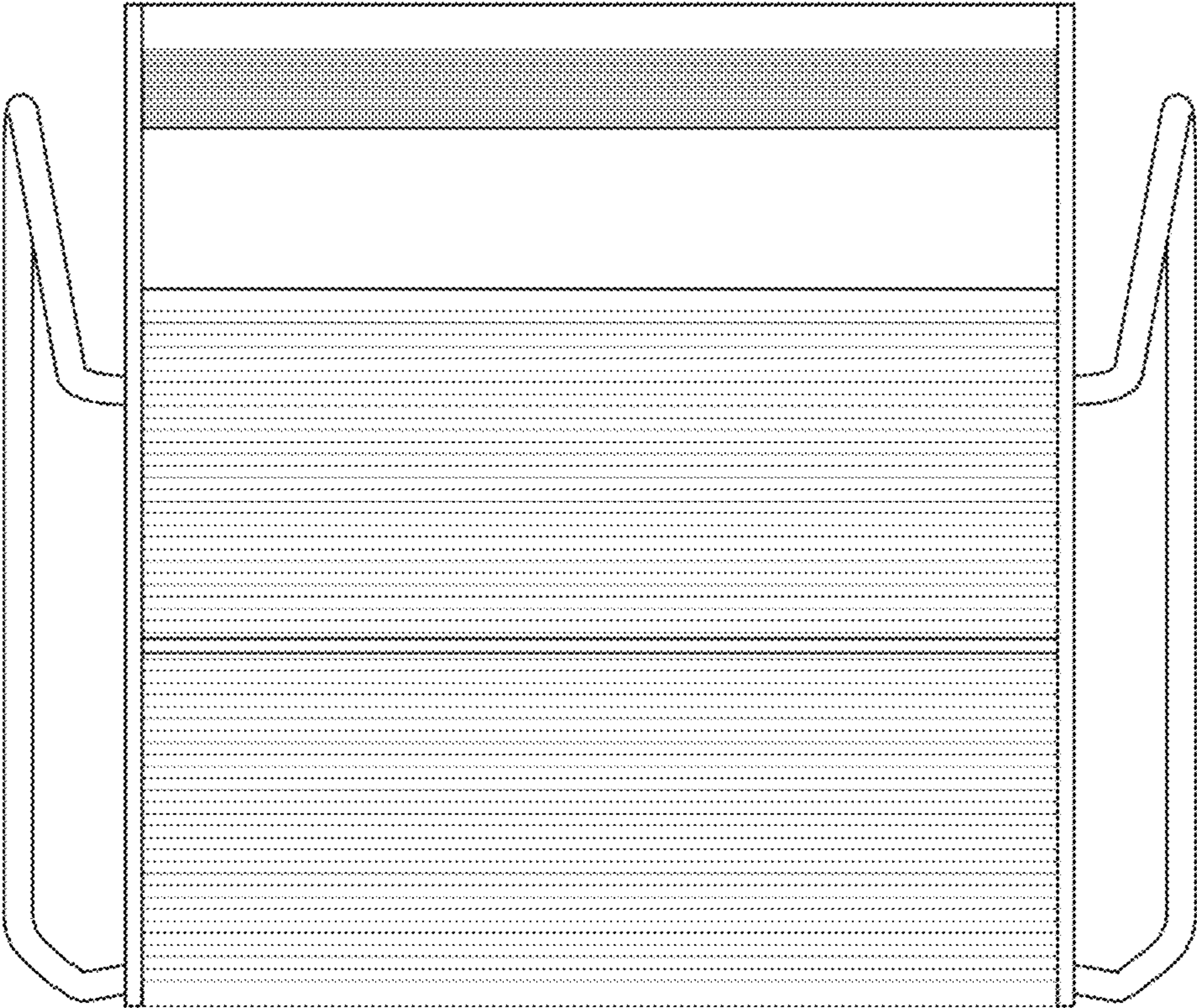

Fig. 12

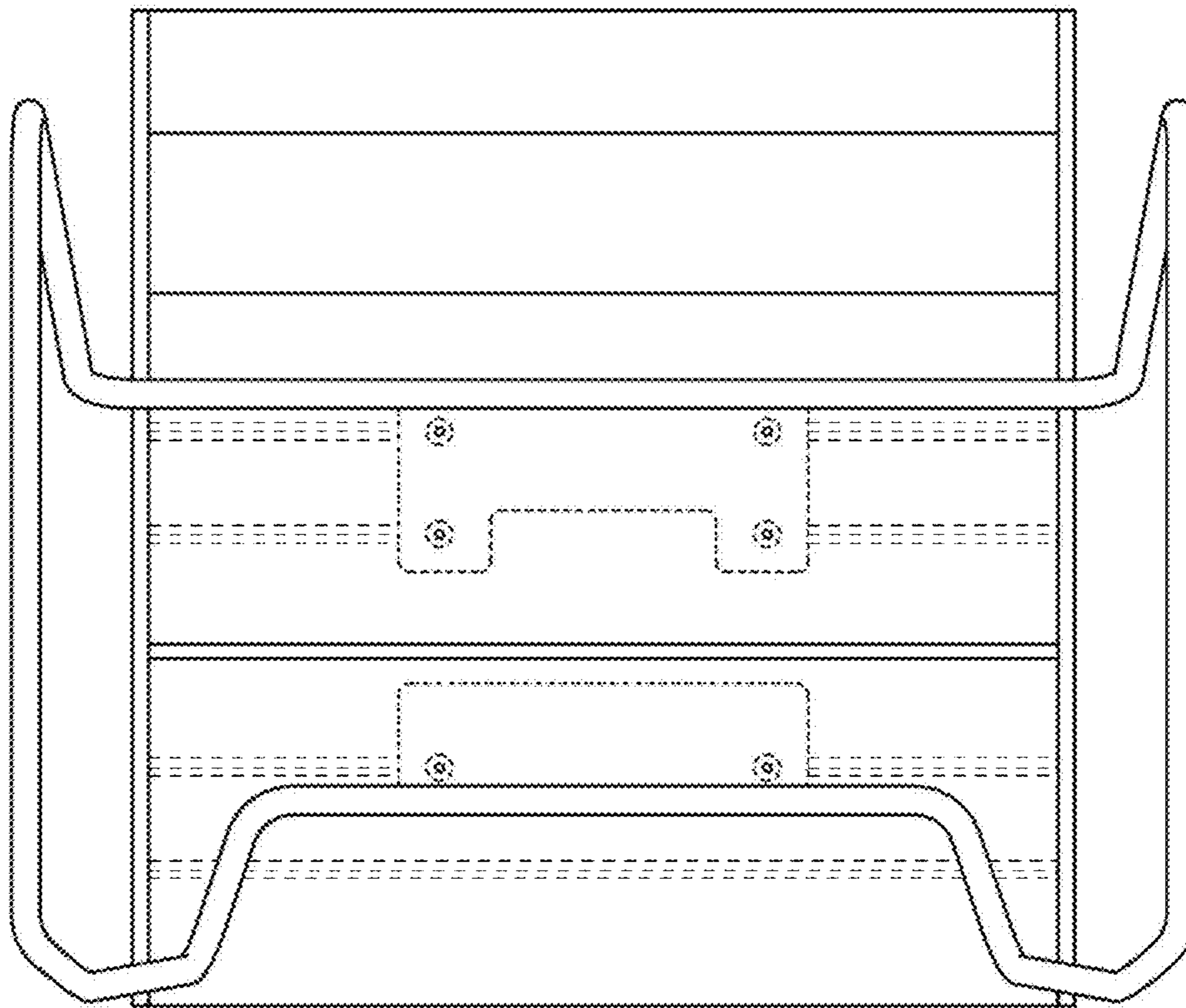

Fig. 13

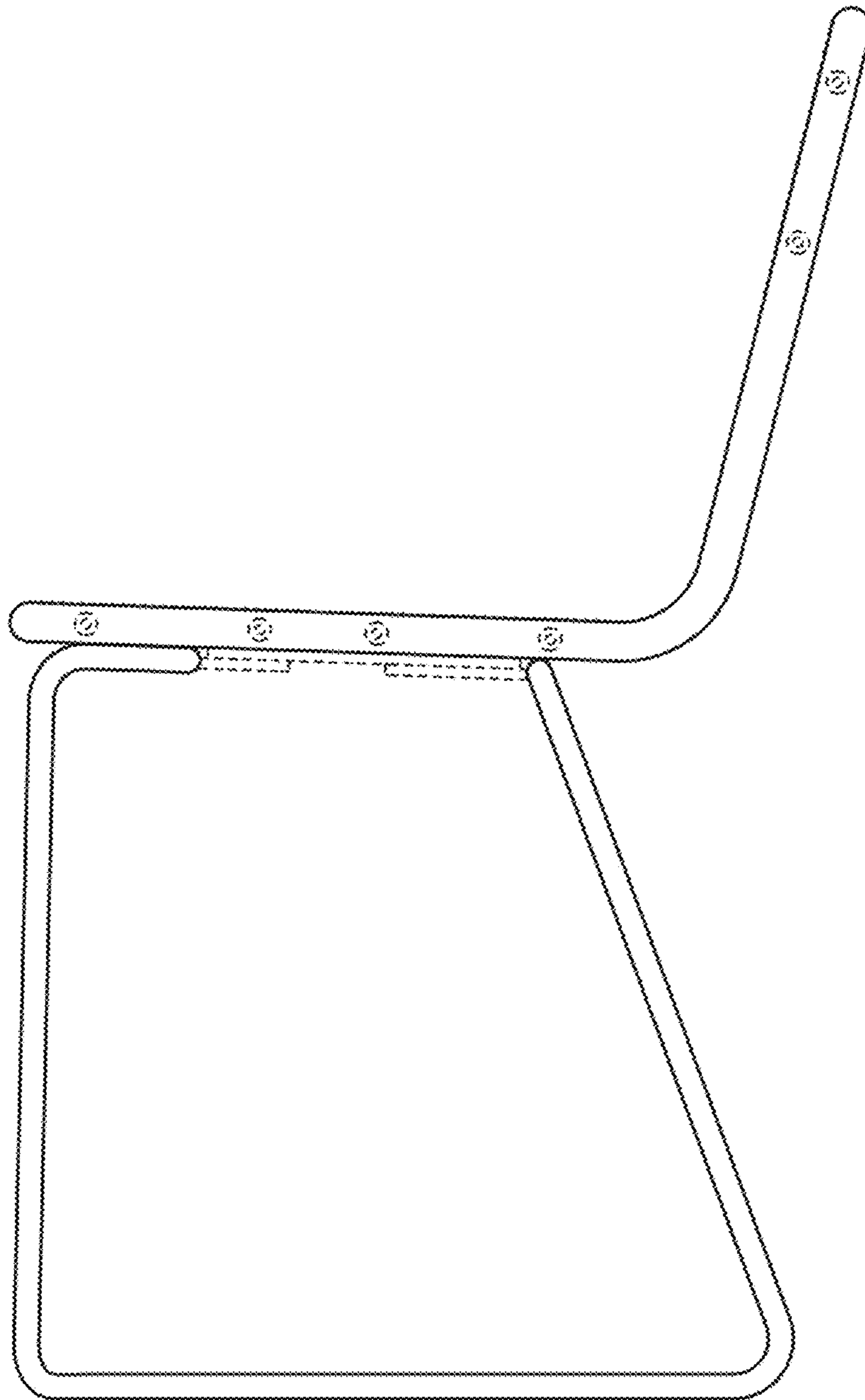

Fig. 14