



US00D825179S

(12) **United States Design Patent**
Tomasetta

(10) **Patent No.:** **US D825,179 S**

(45) **Date of Patent:** **** Aug. 14, 2018**

(54) **HANDBAG**

(71) Applicant: **Chloe S.A.S.**, Paris (FR)

(72) Inventor: **Marco Ettore Tomasetta**, Paris (FR)

(73) Assignee: **Chloe S.A.S.**, Paris (FR)

(**) Term: **15 Years**

(21) Appl. No.: **29/599,054**

(22) Filed: **Mar. 30, 2017**

(30) **Foreign Application Priority Data**

Nov. 23, 2016 (EM) 003479013

(51) **LOC (11) Cl.** **03-01**

(52) **U.S. Cl.**
USPC **D3/243**

(58) **Field of Classification Search**

USPC D3/232-233, 240-243, 245-246

CPC A45C 1/024; A45C 3/06

See application file for complete search history.

(56) **References Cited**

U.S. PATENT DOCUMENTS

D436,437 S * 1/2001 Guyon D3/232

D441,528 S * 5/2001 Guyon D3/232

D786,552 S * 5/2017 Maier D3/243

* cited by examiner

Primary Examiner — Holly H Baynham

(74) *Attorney, Agent, or Firm* — Fross Zelnick Lehrman & Zissu, P.C.; Charles T. J. Weigell, Esq.

(57) **CLAIM**

The ornamental design for a handbag, as shown and described.

DESCRIPTION

FIG. 1 is a front perspective view of a handbag showing my new design;

FIG. 2 is another perspective view thereof;

FIG. 3 is a front view thereof;

FIG. 4 is a back view thereof;

FIG. 5 is a left side view thereof;

FIG. 6 is a right side view thereof;

FIG. 7 is a top view thereof;

FIG. 8 is a bottom view thereof; and,

FIG. 9 is a front view of the handbag shown in FIG. 1, with lock shown in an open position and zipper shown unzipped. The broken lines showing a shoulder strap are for the purposes of illustrating environment and form no part of the claimed design.

The dotted lines other than those depicting the shoulder strap are understood to represent stitching and are part of the claimed design.

1 Claim, 7 Drawing Sheets

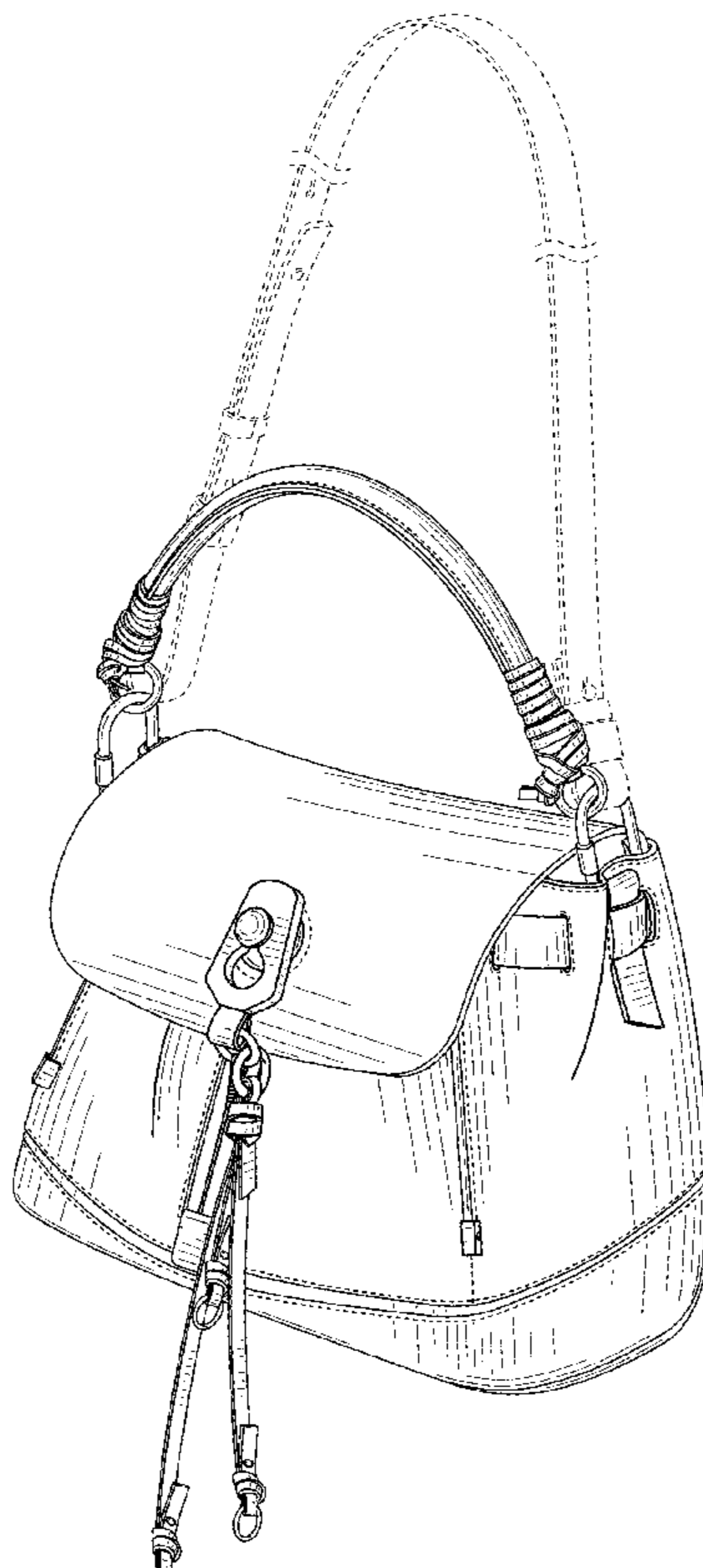

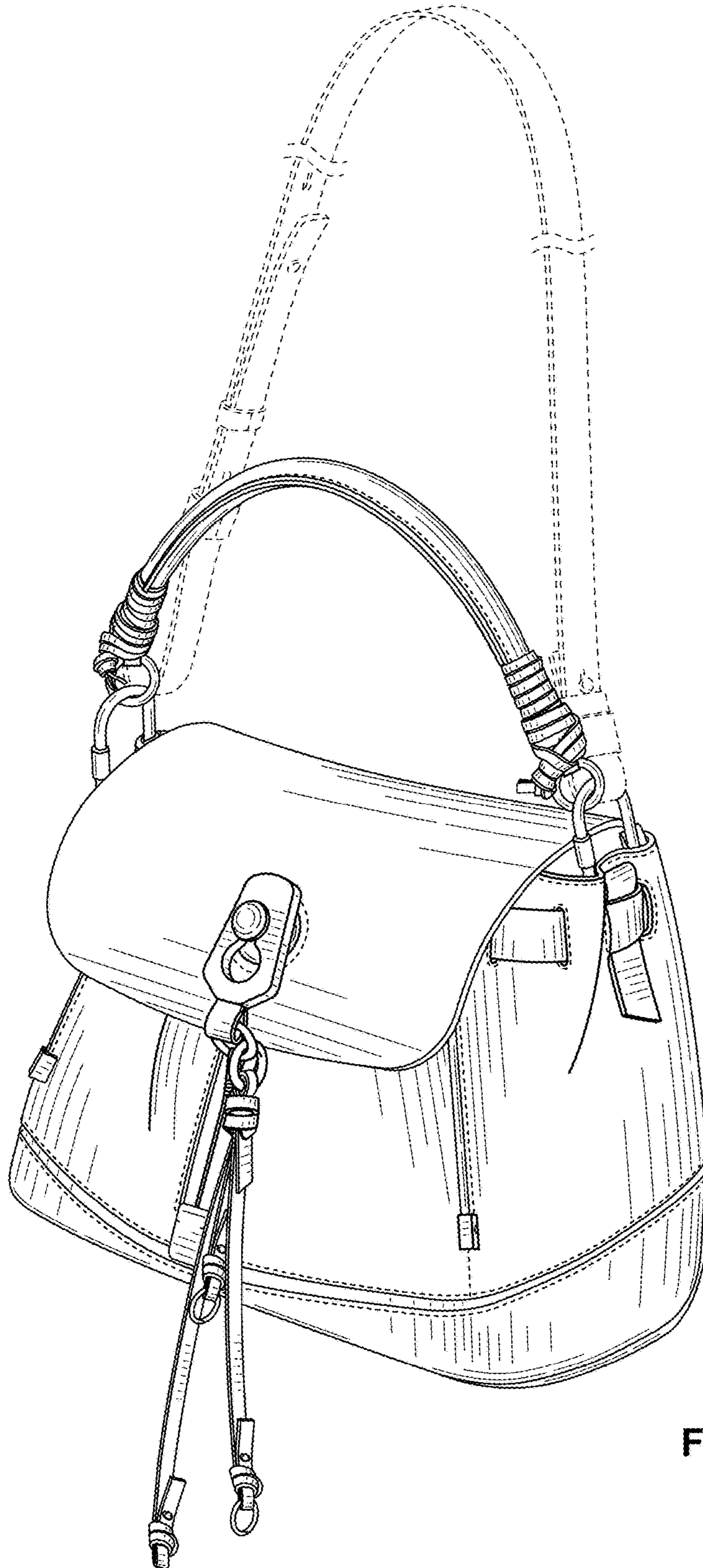

FIG. 1

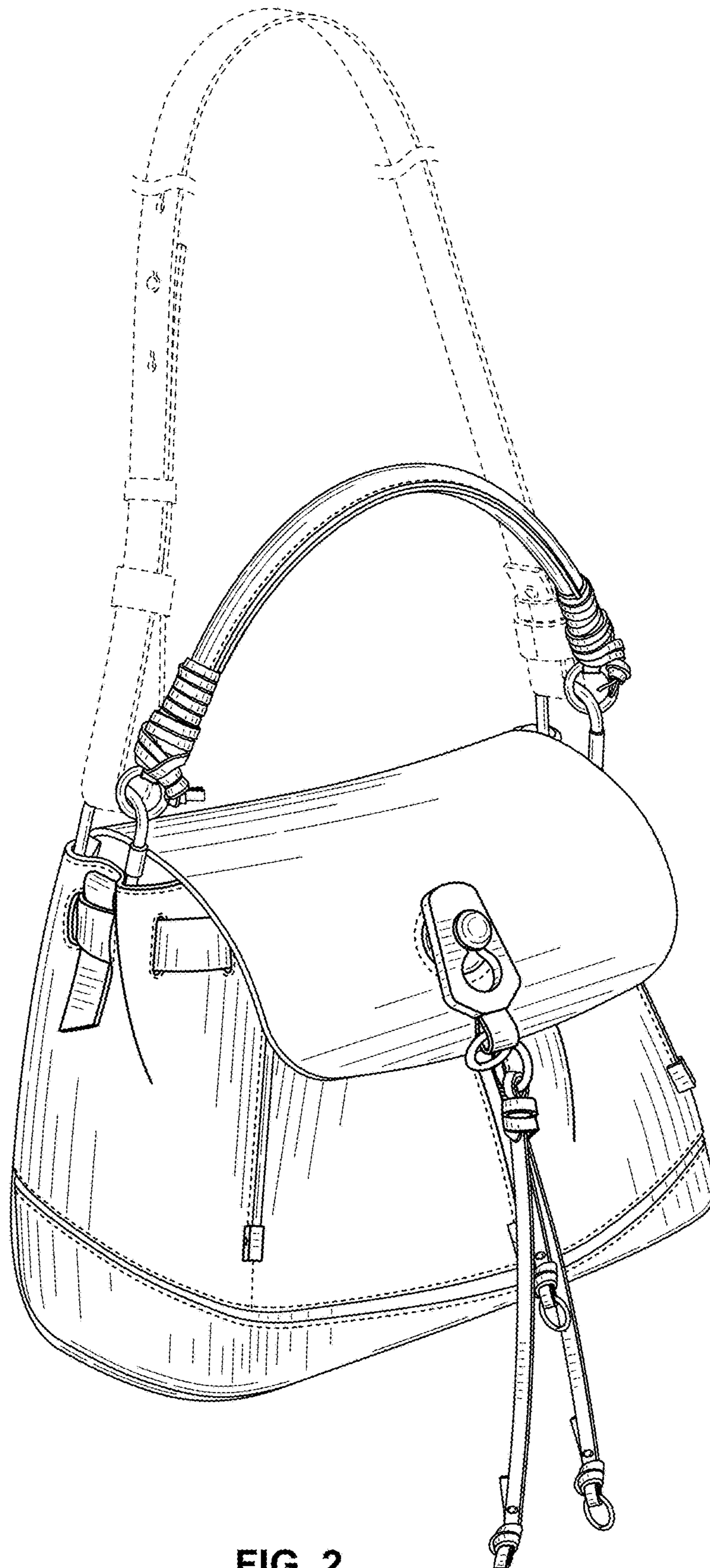

FIG. 2

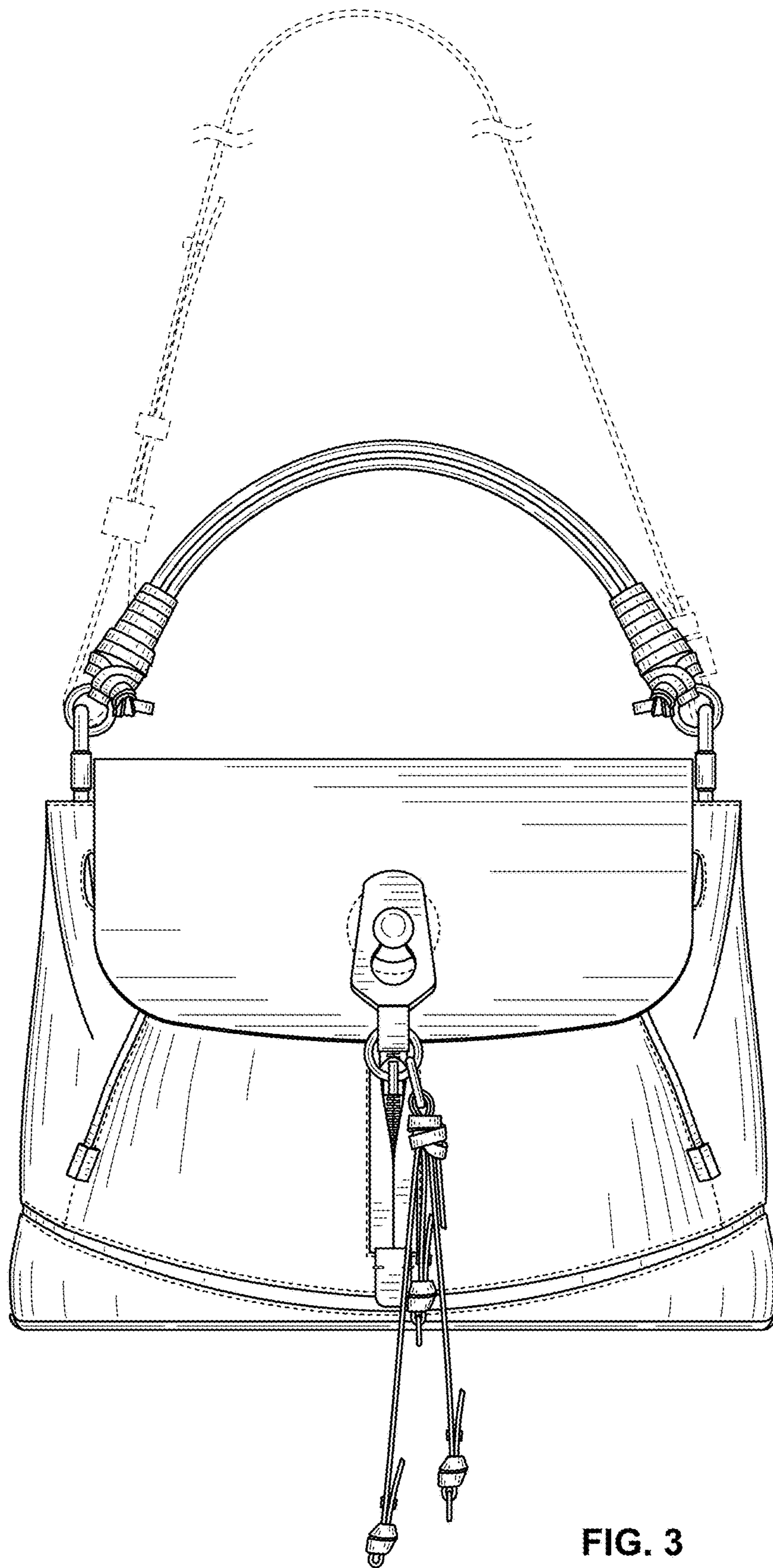

FIG. 3

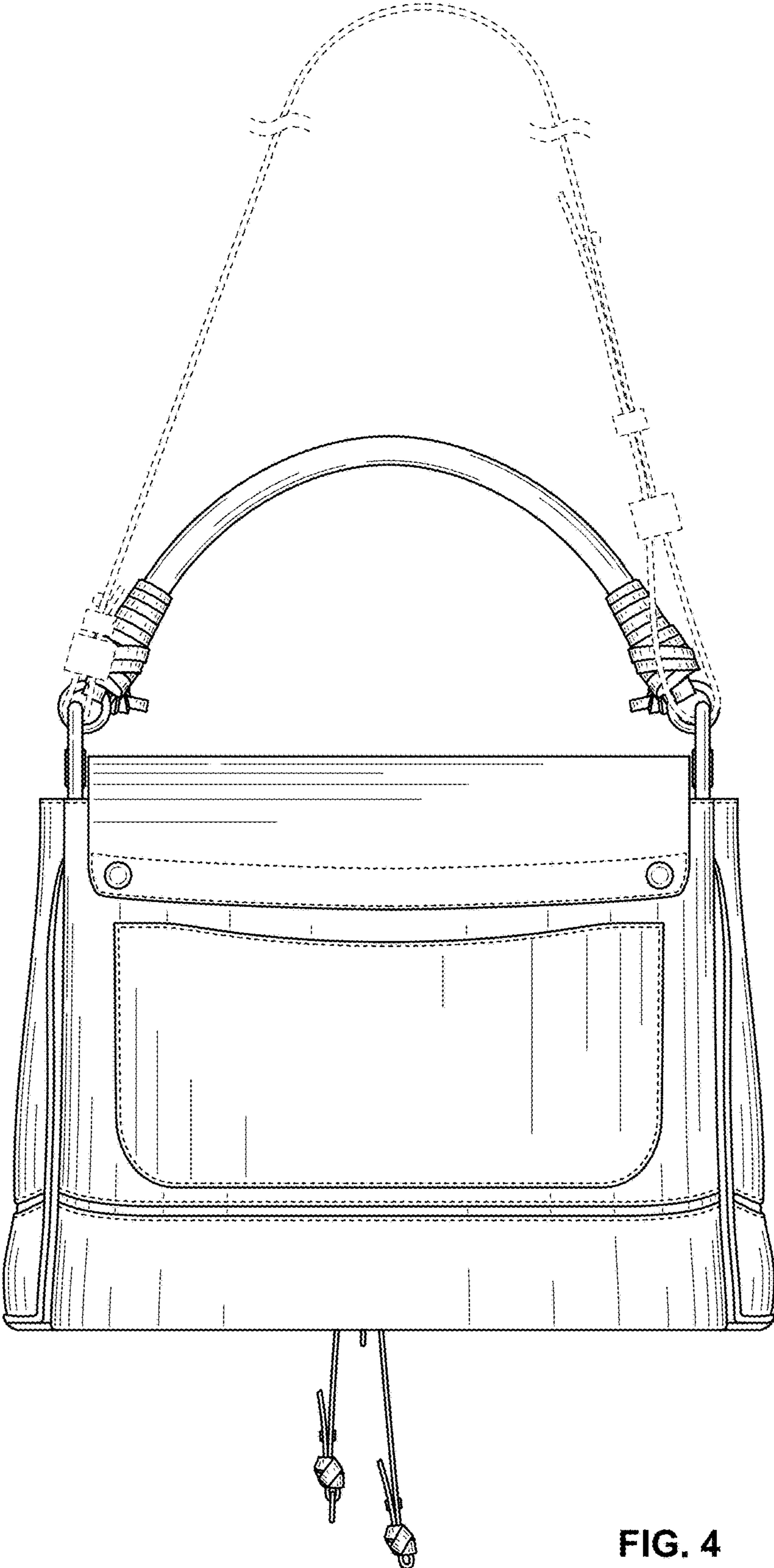

FIG. 4

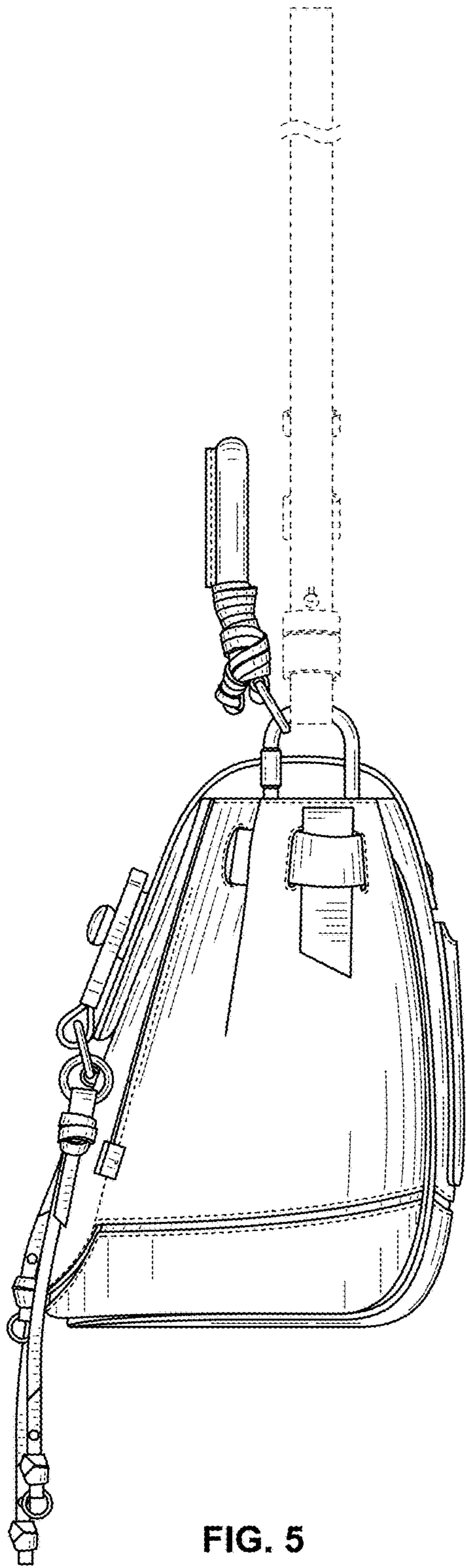

FIG. 5

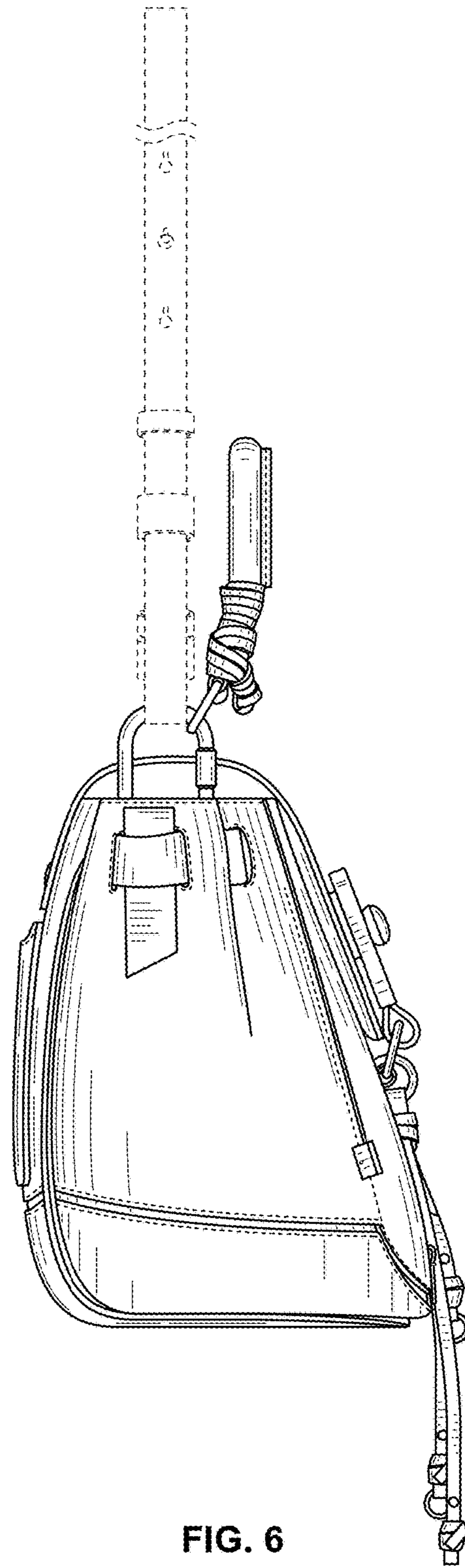

FIG. 6

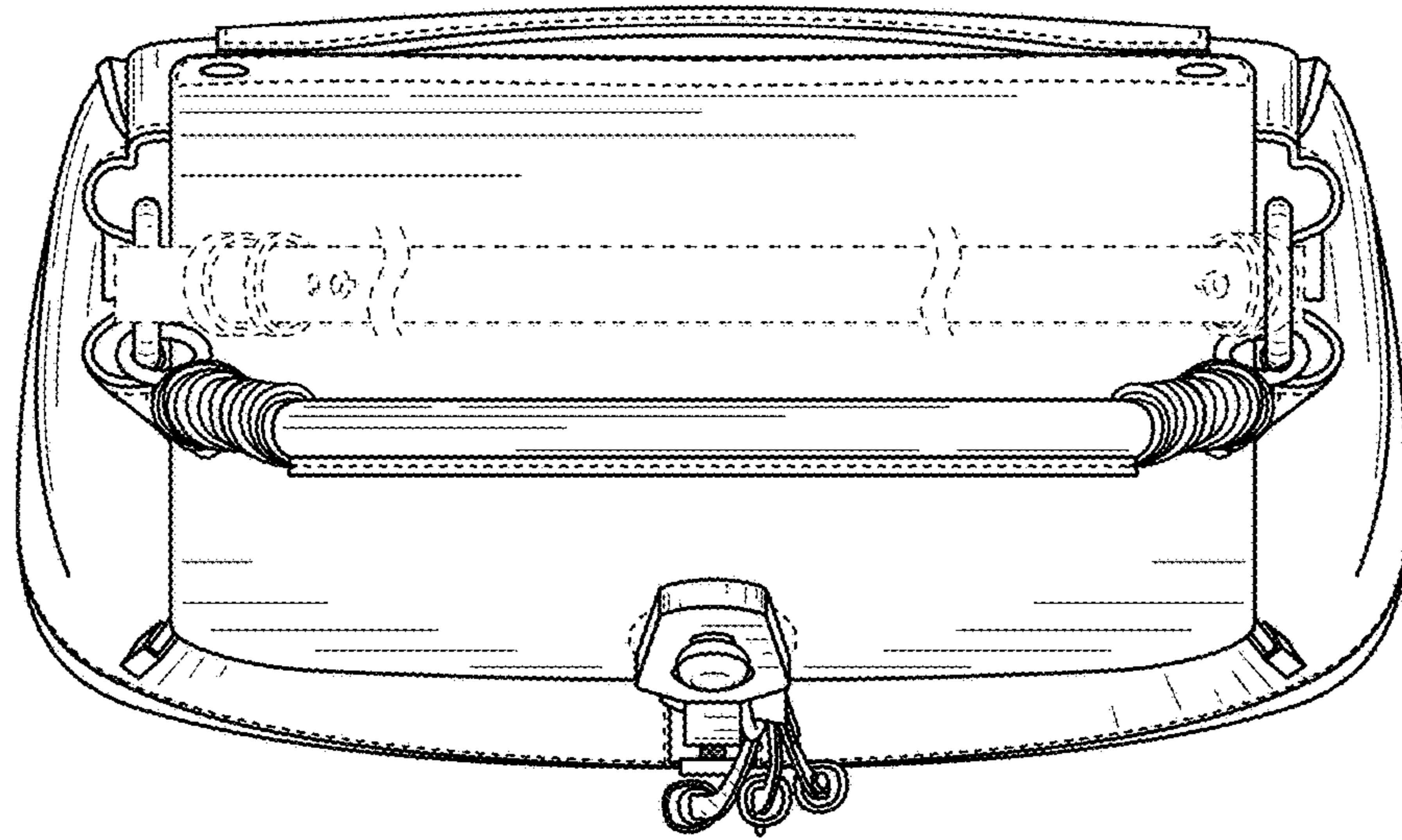

FIG. 7

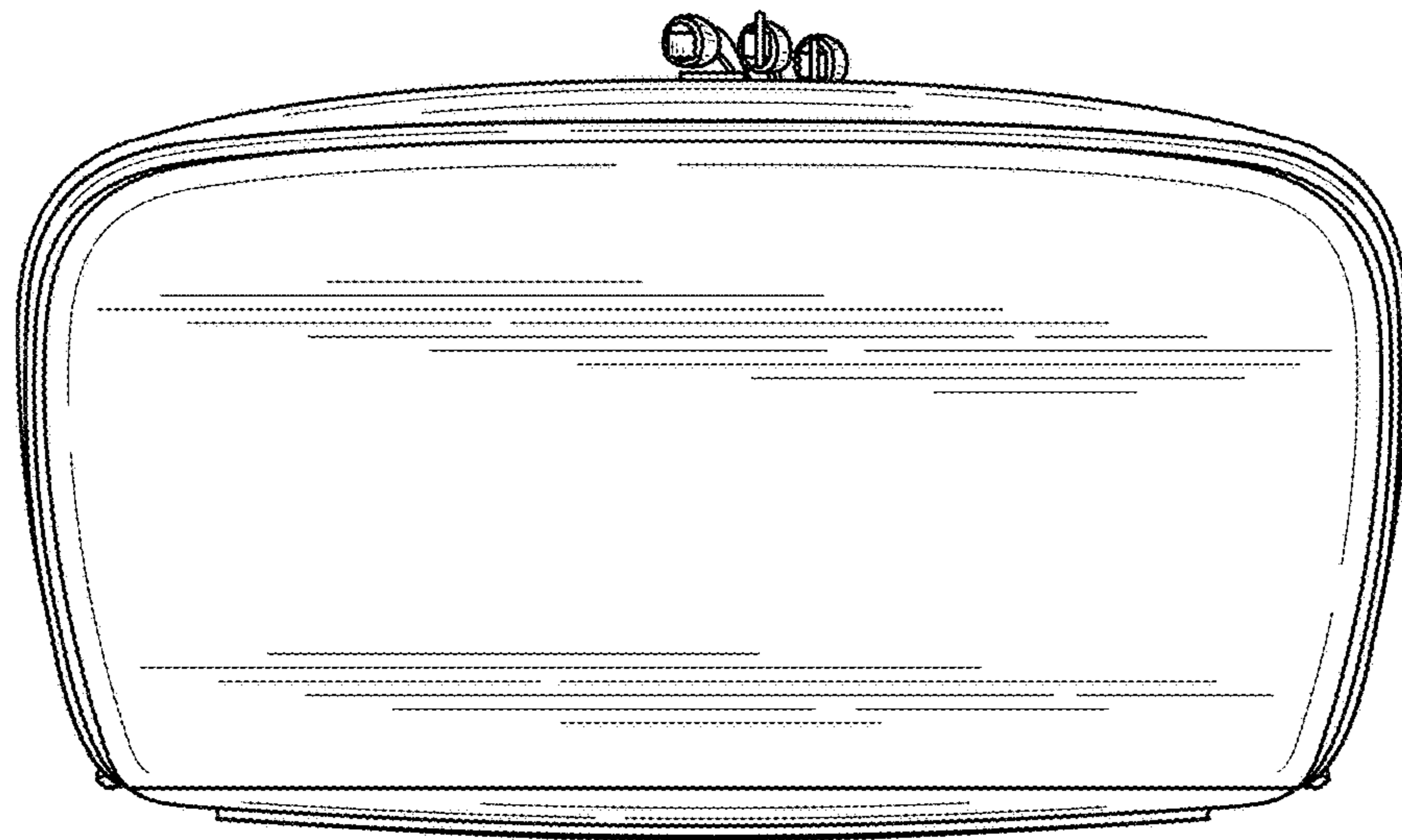

FIG. 8

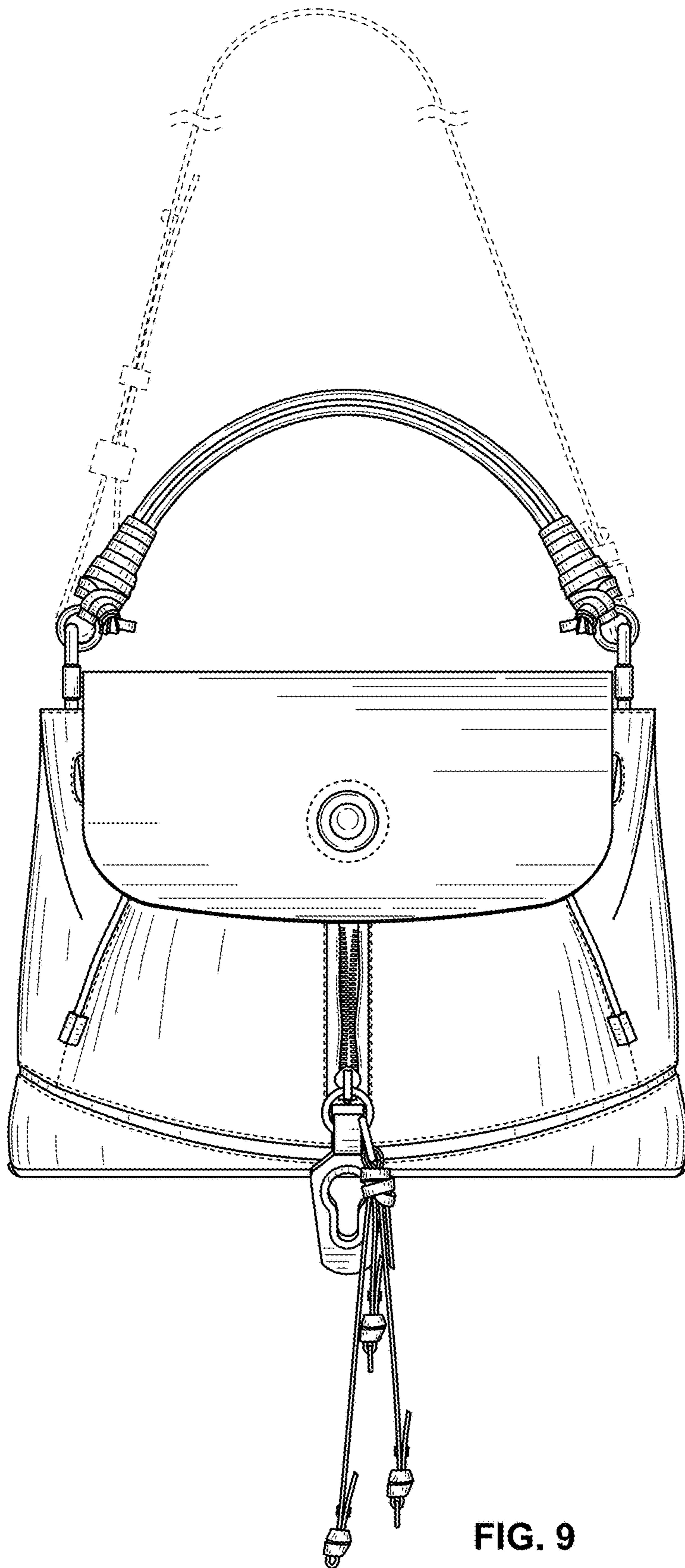

FIG. 9