



US00D825160S

(12) **United States Design Patent** (10) **Patent No.:** **US D825,160 S**
Gavrieli et al. (45) **Date of Patent:** **** *Aug. 14, 2018**

- (54) **BLUE SOLE AND MIDSOLE ASSEMBLY FOR SINGLE-SOLE SHOE** 1,214,666 A 2/1917 Ford
1,519,009 A 12/1924 Reina
1,525,848 A * 2/1925 Bonaventure A43B 5/12
36/113
- (71) Applicant: **Gavrieli Brands, LLC**, Beverly Hills, CA (US) 1,587,377 A 6/1926 Grosjean
1,650,466 A 11/1927 Righter
2,224,590 A 12/1940 Boivin
- (72) Inventors: **Kfir Gavrieli**, Los Angeles, CA (US); 2,268,777 A 1/1942 Scholl
Dikla Gavrieli, Los Angeles, CA (US) D133,819 S 9/1942 Harris
D135,791 S 6/1943 Beebe
- (73) Assignee: **Gavrieli Brands LLC**, Beverly Hills, CA (US) 2,323,563 A 7/1943 Nugent
2,342,882 A 2/1944 Meltzer
D141,871 S 7/1945 Braun
2,383,585 A 8/1945 Bindner
D149,685 S 5/1948 Sandler
D150,729 S 8/1948 Sandler
D166,090 S 3/1952 Maling
2,772,488 A 12/1956 Meltzer
2,904,814 A 9/1959 Scholl
3,148,378 A 9/1964 Tibbitts
D200,897 S 4/1965 Mitchell
D220,494 S 4/1971 Hayoshi
- (*) Notice: This patent is subject to a terminal disclaimer. D247,396 S * 3/1978 Schlerth D2/939
4,412,393 A 11/1983 Terlizzi, Jr. et al.
D275,525 S 9/1984 Nakao
4,674,206 A 6/1987 Lyden
D295,692 S * 5/1988 Zuidema D2/950
D300,085 S 3/1989 Ito et al.
RE33,018 E 8/1989 Ostrander
- (**) Term: **15 Years** 4,899,412 A 2/1990 Ganon
D316,773 S 5/1991 Valle
5,012,541 A 5/1991 Ganon
D339,669 S * 9/1993 Miller D2/919
5,282,326 A 2/1994 Schroer, Jr. et al.
5,421,050 A 6/1995 Laganas
5,699,629 A 12/1997 Munschy
5,746,014 A 5/1998 Tanemoto
D420,785 S 2/2000 Perez
6,055,745 A 5/2000 Endoh
6,076,284 A 6/2000 Terlizzi
6,189,239 B1 2/2001 Gasparovic et al.
6,338,207 B1 1/2002 Chang
D457,292 S * 5/2002 Sessa D2/949
D461,947 S 8/2002 Merceron
6,588,124 B2 6/2003 Morrone
D476,798 S 7/2003 Reynolds et al.
D498,041 S 11/2004 McClaskie
D500,191 S * 12/2004 Belley D2/969
D501,706 S 2/2005 McClaskie
6,857,203 B2 2/2005 Minden
6,895,693 B2 5/2005 Baruck
6,978,557 B2 12/2005 Lee
7,032,327 B1 4/2006 Tartaglia et al.
- (21) Appl. No.: **29/570,799**
- (22) Filed: **Jul. 12, 2016**

Related U.S. Application Data

- (63) Continuation of application No. 29/493,446, filed on Jun. 10, 2014, now abandoned.
- (51) **LOC (11) Cl.** **02-99**
- (52) **U.S. Cl.**
USPC **D2/950**
- (58) **Field of Classification Search**
USPC D2/896, 900, 919-921, 925, 939, 947,
D2/950, 969, 971; 36/1, 83, 8.1-8.3, 9 R,
36/45-58, 104, 108, 76 R
CPC A43B 21/00; A43B 21/02; A43B 21/06;
A43B 9/14; A43B 1/0045; A43B 13/10;
A43B 13/12; A43B 23/06; A43B 23/07;
A43B 1/0036; A43B 5/12
See application file for complete search history.

(56) **References Cited**

U.S. PATENT DOCUMENTS

- 249,086 A 11/1881 Pienovi
773,850 A 11/1904 Cooper et al.
830,941 A 9/1906 Walden
1,208,209 A 12/1916 Prince

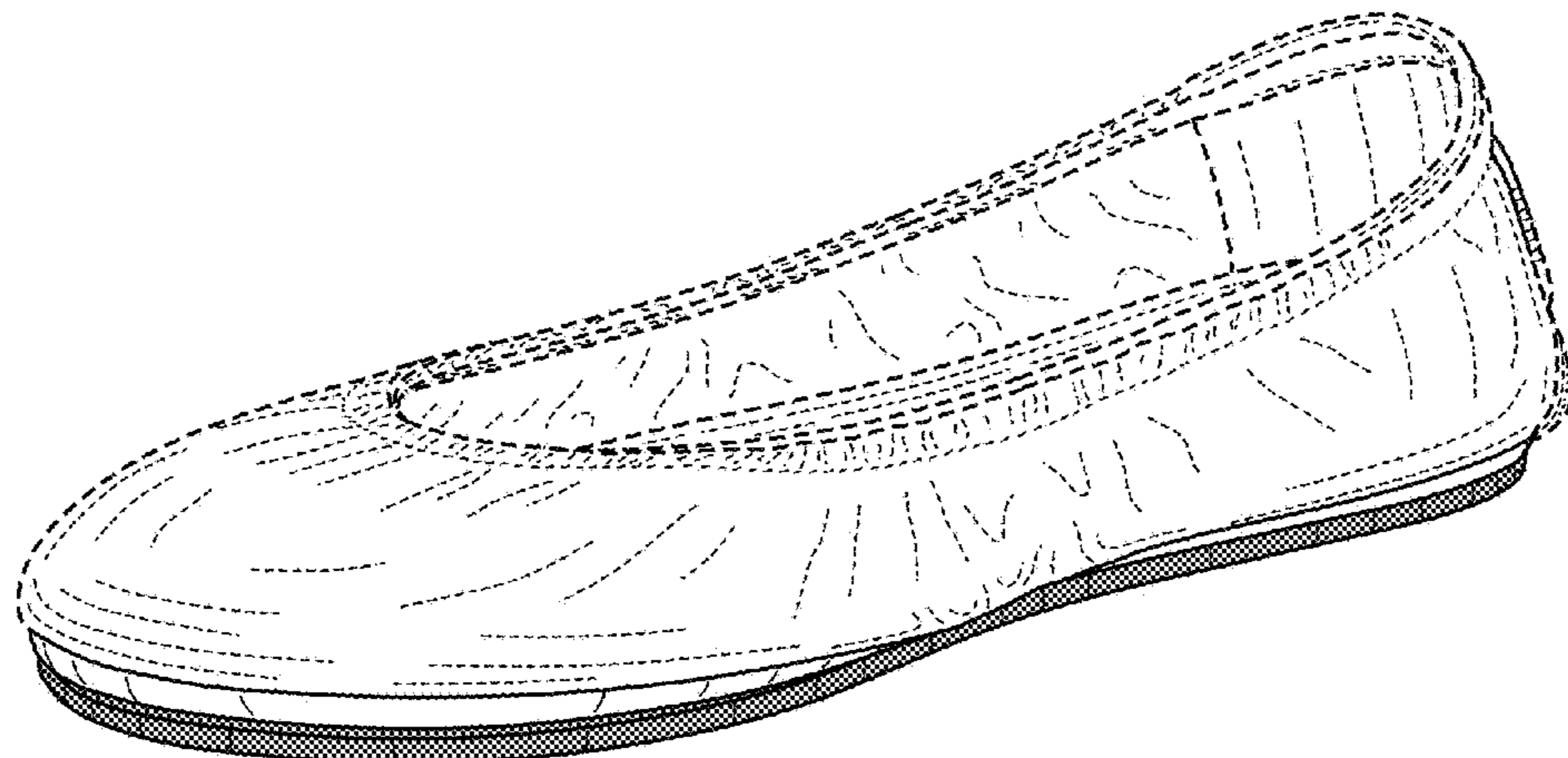

7,036,244	B1	5/2006	Finch	
D527,513	S	9/2006	Della Valle	
D529,513	S *	10/2006	Aketa	D15/5
D531,790	S	11/2006	Wurzburg	
D534,341	S *	1/2007	Choi	D2/896
D542,513	S	5/2007	Amado et al.	
D556,990	S	12/2007	Cabados	
7,337,558	B2	3/2008	Terlizzi et al.	
D567,485	S	4/2008	James	
D570,488	S	6/2008	Kirksey et al.	
D571,084	S	6/2008	Comeau	
D571,548	S	6/2008	Seamans	
D571,989	S	7/2008	Siegal	
D580,640	S	11/2008	Wurzburg	
D582,638	S	12/2008	Ringholz	
7,496,982	B2	3/2009	Clark et al.	
7,506,459	B2	3/2009	Grisoni et al.	
D591,031	S	4/2009	Cofinco	
D593,295	S *	6/2009	Belley	D2/969
D593,297	S *	6/2009	Belley	D2/969
D593,307	S *	6/2009	Belley	D2/969
D599,093	S *	9/2009	Issler	D2/925
D604,030	S	11/2009	Wilson	
D607,194	S	1/2010	Zagula	
D610,332	S	2/2010	Raichle	
D610,785	S	3/2010	Smith	
D612,140	S	3/2010	Moon	
D612,141	S	3/2010	Moon	
7,694,435	B1	4/2010	Kiser et al.	
D615,737	S	5/2010	Feller	
7,735,244	B1	6/2010	Ameche	
7,743,530	B2	6/2010	Truelsen	
D618,891	S	7/2010	McClaskie	
7,757,408	B2	7/2010	McClaskie	
D630,829	S	1/2011	Weisner	
D632,881	S	2/2011	Rosenberg	
7,926,203	B2	4/2011	Wilkenfeld	
7,966,747	B2	6/2011	Wilkenfeld et al.	
D640,861	S	7/2011	Wilkenfeld	
8,020,320	B2	9/2011	Gillespie	
8,127,468	B2	3/2012	Morgan	
D657,543	S	4/2012	Bove	
D659,960	S	5/2012	Bizzo	
8,230,619	B2	7/2012	Salvatelli	
D664,755	S	8/2012	Gavrieli et al.	
D665,157	S	8/2012	Wu	
8,240,067	B2	8/2012	Sussmann	
8,245,420	B2	8/2012	Wilson	
D668,027	S	10/2012	Millieret	
D668,438	S	10/2012	Millieret	
D668,847	S *	10/2012	Gavrieli	D2/925
D668,848	S *	10/2012	Gavrieli	D2/925
D668,849	S	10/2012	Pozzi	
D668,850	S	10/2012	Pozzi	
D672,542	S	12/2012	Gray et al.	
D676,634	S *	2/2013	Gavrieli	D2/925
D681,927	S *	5/2013	Gavrieli	D2/925
D681,928	S *	5/2013	Gavrieli	D2/925
D681,929	S *	5/2013	Gavrieli	D2/925
D683,936	S *	6/2013	Gavrieli	D2/925
8,468,723	B2	6/2013	Malka-Harari	
D686,812	S	7/2013	Gavrieli et al.	
8,510,975	B2	8/2013	Krikelis	
D688,853	S *	9/2013	Gavrieli	D2/925
D688,854	S *	9/2013	Gavrieli	D2/925
D688,855	S *	9/2013	Gavrieli	D2/925
D689,270	S *	9/2013	Gavrieli	D2/925
D689,271	S *	9/2013	Gavrieli	D2/925
D689,272	S *	9/2013	Gavrieli	D2/925
D690,914	S *	10/2013	Gavrieli	D2/925
D690,915	S *	10/2013	Gavrieli	D2/925
D696,500	S	12/2013	Hunt	
D699,424	S	2/2014	Hamm	
8,661,714	B2	3/2014	Sussman	
8,745,893	B2	6/2014	Gavrieli et al.	
8,973,287	B2	3/2015	Shibata	
2002/0078591	A1	6/2002	Morrone	
2002/0129519	A1	9/2002	Cahan	
2003/0070319	A1	4/2003	Minden	

2003/0121176	A1	7/2003	Baruck
2004/0025377	A1	2/2004	Brannon
2005/0022421	A1	2/2005	Bruckner
2005/0115115	A1	6/2005	Lacey
2005/0217148	A1	10/2005	Connolly et al.
2005/0262734	A1	12/2005	Cheng
2006/0086005	A1	4/2006	Yerian
2006/0156576	A1	7/2006	Sloan
2007/0074424	A1	4/2007	Lin
2007/0204482	A1	9/2007	Gibson-Collinson
2007/0204483	A1	9/2007	Kirsch et al.
2008/0052964	A1	3/2008	Taylor
2008/0086912	A1	4/2008	Wilkenfeld
2008/0110059	A1	5/2008	Kuramoto et al.
2009/0019732	A1	1/2009	Sussmann
2009/0193685	A1	8/2009	Wilson
2009/0205222	A1	8/2009	Mclinden
2009/0272009	A1	11/2009	Weisner et al.
2010/0011625	A1	1/2010	Percival
2010/0018080	A1	1/2010	Smith
2010/0050469	A1	3/2010	Chen
2010/0095557	A1	4/2010	Jarvis
2010/0115793	A1	5/2010	Kraisosky
2010/0122475	A1	5/2010	Purrington
2010/0146822	A1	6/2010	MacGregor
2010/0212186	A1	8/2010	Cheng
2010/0275462	A1	11/2010	Pucci
2010/0281713	A1	11/2010	Pantazes
2015/0089843	A1	4/2015	Gavrieli

FOREIGN PATENT DOCUMENTS

DE	20	2006	000230	U1	5/2007
GB			2443937	A	5/2008
GB			2 446 205	A	8/2008
TW			D119165		10/2007

OTHER PUBLICATIONS

Examination Report for AU 341324, 3 pgs., dated Oct. 24, 2012.
 Letter from TMI and Associates with Office Action, 2 pgs, dated Sep. 19, 2012 <http://www.payless.com/store/?&TLC=Womens&SLC=WomensNewArrivals&BLC=WomensNewArrivalsNewArrivals&With+Regular&ItemCode=60131&LotNumber=062642&Type=Adult&Popularity=637&Descriptvein>.
 Taiwanese Office Action for TW 101300726, 10 pgs., dated Sep. 6, 2012.
 “The Love List, Tieks by Gavrieli—Foldable Ballet Flats,” <http://thelovelist-carly.blogspot.com.au/2010/09/tieks-by-gavrieli-foldable-ballet.html>, 3 pgs., Sep. 12, 2010.
 “Tieks by Gavrieli,” <http://tieks.com> 1 pg., retrieved Mar. 13, 2013 from URL.
 “Try It Mummy!, Tieks by Gavrieli,” <http://tryitmummy.blogspot.com.au/2010/12/tieks-by-gavrieli.html>, 4 pgs., Dec. 9, 2010.
 “Wearability—Real People Style, What came first, the City Flat or the Tieks,” <http://wearability.posterous.com/what-came-first-the-city-flat-or-the-tieks>, 4 pgs., Aug. 29, 2010.
 “The Ballet Flat . . . Reinvented; Ballet Flats . . . with a Bonus; Step Into Tieks; Going Places? Take Tieks,” <http://web.archive.org/web/2010052004346/http://www.tieks.com/>; 4 pgs., May 24, 2010.
 “Tieks—Comfortable designer flats you can fit in your purse and wear all day, every day,” <http://web.archive.org/web/20110731151555/http://tieks.com/>; 6 pgs., Jul. 31, 2011.
 “58th Annual Emmy Awards,” http://spoonsforksandfashion.blogspot.com/2006_08_01_archive.html, depicting Nine West flats, 11 pgs., Aug. 1, 2006.
 Pictures of Nine West flats sold in 2006, 3 pgs.
 “I Love a Good Ballet Flat!,” <http://dressupfiles.com/i-love-a-good-ballet-flat>, depicting Sue London flats, 4 pgs., Sep. 3, 2010.
 Pictures of Sue London flats sold in 2010, 2 pgs.
 “Miss Cathie Reviews: The Yosi Samra Foldable Ballet Flat . . .,” <http://www.misscathie.com/2010/01/miss-cathie-reviews-the-yosi-samra-foldable-ballet-flat/>, depicting Yosi Samra flats, 7 pgs., Jan. 2010.

Pictures of Yosi Samra flats sold in 2010, 2 pgs.
 “Goodbye two thousand ten,” http://emmajoyrussell.blogspot.com/2010_12_01_archive.html, depicting Gap flats, 39 pgs., Dec. 1, 2010.
 Pictures of Gap flats available for sale in 2010, 9 pgs.
 “Our newest design of folding flats—Pink,” <https://fitinclouds.wordpress.com/2010/05/16/our-newest-design-of-folding-flats-pink/>, depicting Fit in Clouds flats, 1 pg., May 16, 2010.
 “Fit in Clouds Satin Folding Shoes,” <http://www.goodhousekeeping.com/product-reviews/clothing/best-ballet-flats/fit-in-clouds-satin-foldable-ballet-flats>, depicting Fit in Clouds flats, 1 pg., Aug. 2013.
 Pictures of Fit in Clouds flats available for sale in 2011, 4 pgs.
 “Shoes for Standing,” <https://truthinshoes.wordpress.com/2008/07/>, depicting Sam & Libby flats, 2 pgs., Jul. 31, 2008.
 “Target Designer Collaboration: Announcing Sam & Libby Shoes for Target,” <http://www.therecessionista.com/2012/11/target-designer-collaboration-announcing-sam-libby-shoes-for-target.html>, depicting Sam & Libby flats, 1 pg., Nov. 26, 2012.
 Pictures of Sam & Libby flats available for purchase in 2011, 5 pgs.
 “Save your soles with Citisoles ballet flats,” <http://glamazondiaries.com/2009/07/save-your-soles-with-citisoles-ballet-flats>, depicting Citisoles flats, 3 pgs., Jul. 2009.
 Pictures of Citisoles flats available for purchase in 2009, 3 pgs.
 “#16 Corso Como Delicious Pumps Review and Giveaway!,” <http://www.mommatoldmeblog.com/2011/01/16-corso-como-delicious-pumps-review.html>, depicting Corso Como flats, 8 pgs., Jan. 16, 2011.
 Pictures of Corso Como flats available for sale in 2011, 3 pgs.
 “jil-sander-navy-lead-ballet-flats-product . . . ,” www.ebay.com, depicting Jil Sander flats, 4 pgs., Nov. 2013.
 Pictures of Jil Sander flats available for sale in 2011, 3 pgs.
 “Spare Soles: Shoes That Roll-up & Fold-up,” <http://herpackinglist.com/2011/01/spare-soles-shoes/>, depicting Spare Soles flats, 2 pgs., Jan. 2011.
 Pictures of Spare Soles flats available for sale in 2011, 5 pgs.
 The Original Rollable, Foldable ballet flats with matching wristlet—Spare Soles, <http://herpackinglist.com/2011/01/spare-soles-shoes/>, depicting Roll-Upz Spare Soles flats, 2 pgs., Jan. 2011.
 Pictures of Roll-Upz by Spare Soles flats available for sale in 2011, 6 pgs.
 “The Cutest Blog, Preppy 50 and Loving Lilly, Ballet Flat Delight,” <http://preppy50andlovinglilly.blogspot.com/2011/02/ballet-flat-delight.html>, depicting Henri Bendel flats, 13 pgs., Feb. 19, 2011.
 Pictures of Henri Bendel flats available for sale in 2011, 4 pgs.
 “Mumsnet by parents for parents,” http://www.mumsnet.com/Talk/style_and_beauty/a1612000-Anyone-tried-Redfoot-Flatmates-foldable-ballet-pumps, depicting Redfoot Flatmates flats, 1 pg, Nov. 14, 2012.
 Pictures of Redfoot Flatmates flats available for sale in 2011, 6 pgs.
 “Amazon.com: Customer Reviews: Bloch London Women’s Lux Ballet Flat,” <http://www.amazon.com/Bloch-London-Womens-Ballet-Flat/product-reviews/B004LWP7YW>, depicting Bloch London flats, 4 pgs., Dec. 11, 2011.
 Pictures of Bloch London flats offered for sale in 2011, 11 pgs.
 “h&m foldable leopard print flat,” <http://845shops.wordpress.com/2011/06/16/flats-for-7-bucks/shoe1/>, depicting h&m flats, 3 pgs., Jun. 16, 2011.
 Pictures of h&m foldable flats offered for sale in 2011, 4 pgs.
 “Seekyt—Juicy Couture Ballet Flats—Are They Worth the Money?,” <http://seekyt.com/juicy-couture-ballet-flats-are-they-worth-the-money/>, 14 pgs., Jun. 3, 2011.
 Pictures of Juicy Couture flats offered for sale in 2011, 3 pgs.
 “Purse Flats,” <http://purseflats.wordpress.com>, depicting Purse Flats by Erica Wilson, 3 pgs., Jul. 12, 2012.
 Pictures of Purse Flats by Erica Wilson offered for sale in 2011, 6 pgs.
 “Splash Page,” <http://web.archive.org/web/20100524004346/http://www.tieks.com/>, 4 pgs., May 24, 2010.
 “Tieks—Comfortable, designer flats you can fit in your purse and wear all day, every day,” <http://web.archive.org/web/20110731151555/http://tieks.com>, 6 pgs., Jul. 31, 2011.

“Tieks by Gavrieli—Comfortable, designer flats you can fit in your purse and wear all day . . . ,” <http://web.archive.org/web/20110202210649/http://www.tieks.com/>, 8 pgs., Feb. 2, 2011.
 “Carolina M. M. Gonzalez > Tieks by Gavrieli,” http://m2.facebook.com/Tieks?v=timeline&filter=2&timecutoff=1406427986&page=17§ionLoadingID=m_timeline_loading_div_1293868799_1262332800_8_17&timeend=1293868799×tart=1262332800&tm=AQDOvqhWQPN_Nbwm&refid=17, 1 pg. Jan. 26, 2010.
 “The Shoes Oprah Would Wear to Work (if She Had to Walk),” <http://www.inc.com/30under30/christina-desmarais/kfir-gavrieli-and-elram-gavrieli-founders-of-tieks>, 8 pgs., Jul. 2, 2012.
 “Tieks by Gavrieli,” http://m2.facebook.com/Tieks?v=timeline&filter=2&timecutoff=1406427986&page=14§ionLoadingID=m_timeline_loading_div_1293868799_1262332800_8_14&timeend=1293868799×tart=1262332800&tm=AQDOvqhWQPN_Nbwm&refid=17, 4 pgs., Jan. 26, 2010.
 “Mighty Life List, Sensible Shoes,” <http://mightygirl.com/2010/08/24/sensible-shoes/>, 10 pgs., Aug. 24, 2010.
 “Find! Tieks: Fab & sexy flats for fall,” <http://thefabmom.com/2013/08/29/find-tieks-fab-sexy-flats-for-fall/>, 3 pgs. Aug. 29, 2013.
 “Step into Tieks,” <http://sliceofpink.typepad.com/blog/2010/09/tieks-1.html>, 5 pgs., Sep. 22, 2010.
 “In Need of Flat-Soled Shoes,” <http://sliceofpink.typepad.com/blog/2010/09/tieks-1.html>, 7 pgs., Oct. 3, 2010.
 “Say Hello to the Flat Shoes You Need for Fall . . . All 88 of Them!”, Picture of Adam Tucker Shoe/Slipper, <https://www.facebook.com/search/top/?q=adam%20shoes%20slipper>, last accessed Oct. 28, 2016, dated Oct. 1, 2013, 1 page.
 Picture of Adam Tucker Rainbow Shoes, <https://www.facebook.com/search/top/?q=adam%20shoes%20rainbow>, last accessed Oct. 28, 2016, dated Aug. 14, 2013, 1 page.

* cited by examiner

Primary Examiner — Dominic V Simone
 (74) *Attorney, Agent, or Firm* — Morgan, Lewis & Bockius LLP

(57)

CLAIM

The ornamental design for a blue sole and midsole assembly for single-sole shoe, as shown and described.

DESCRIPTION

The file of this patent contains at least one drawing executed in color. Copies of this patent with color drawing(s) will be provided by the Office upon request and payment of the necessary fee.

FIG. 1 is a perspective view of our new design for a blue sole and midsole assembly for single-sole shoe illustrated in conjunction with a disclaimed shoe upper;

FIG. 2 is a first side view thereof;

FIG. 3 is a second side view thereof;

FIG. 4 is a top view thereof;

FIG. 5 is a bottom view thereof;

FIG. 6 is a front view thereof;

FIG. 7 is a back view thereof;

FIG. 8 is a perspective view of another embodiment of our new design of a blue sole and midsole assembly for single-sole shoe illustrated in conjunction with a disclaimed shoe upper of FIG. 1, where the blue portions are indicated using the USPTO convention of horizontal lines for blue;

FIG. 9 is a first side view thereof;

FIG. 10 is a second side view thereof;

FIG. 11 is a top view thereof;

FIG. 12 is a bottom view thereof;

FIG. 13 is a front view thereof;

FIG. 14 is a back view thereof;

FIG. 15 is a perspective view of yet another embodiment of our new design of a blue sole and midsole assembly for single-sole shoe of FIG. 1, illustrated in conjunction with a disclaimed shoe, where the blue portions are indicated using a cross-hatched pattern to indicate the blue color Pantone 7466C;

FIG. 16 is a first side view thereof;

FIG. 17 is a second side view thereof;

FIG. 18 is a top view thereof;

FIG. 19 is a bottom view thereof;

FIG. 20 is a front view thereof; and,

FIG. 21 is a back view thereof.

The broken lines showing elements in the above described Figures are for illustrative purposes only and form no part of the claimed design.

**1 Claim, 18 Drawing Sheets
(5 of 18 Drawing Sheet(s) Filed in Color)**

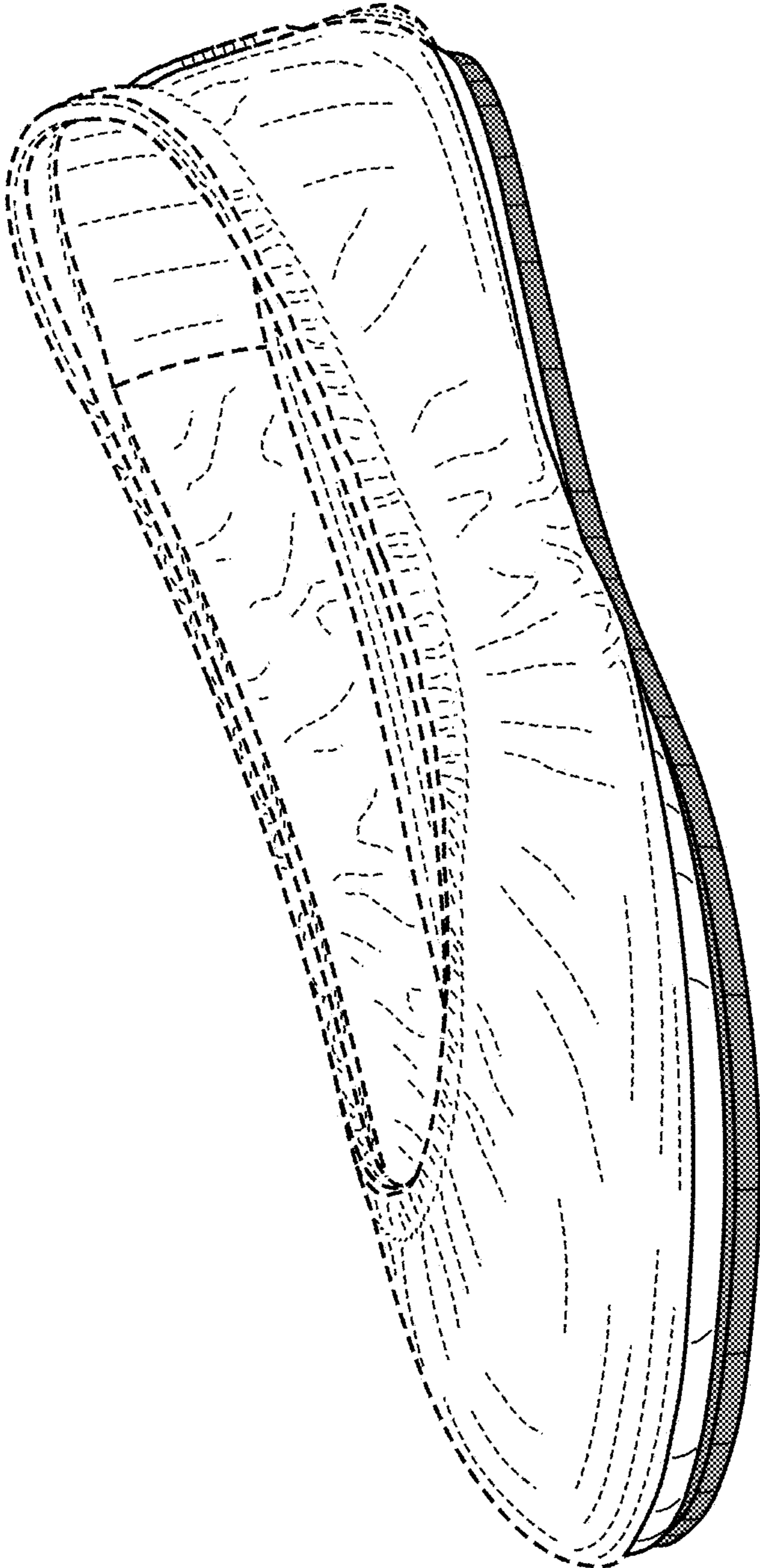

FIG. 1

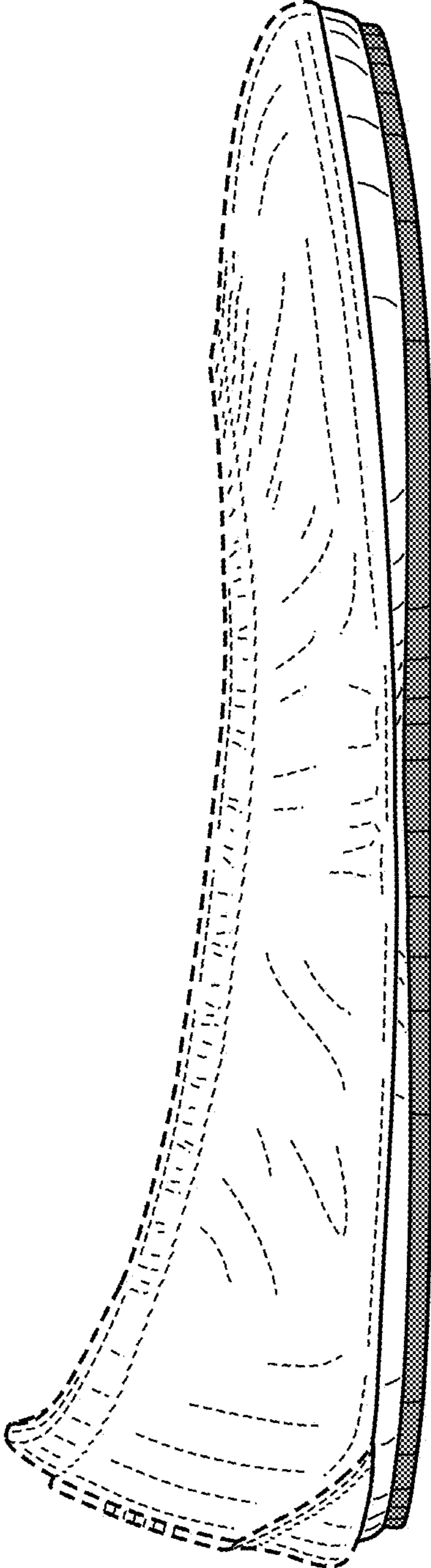

FIG. 2

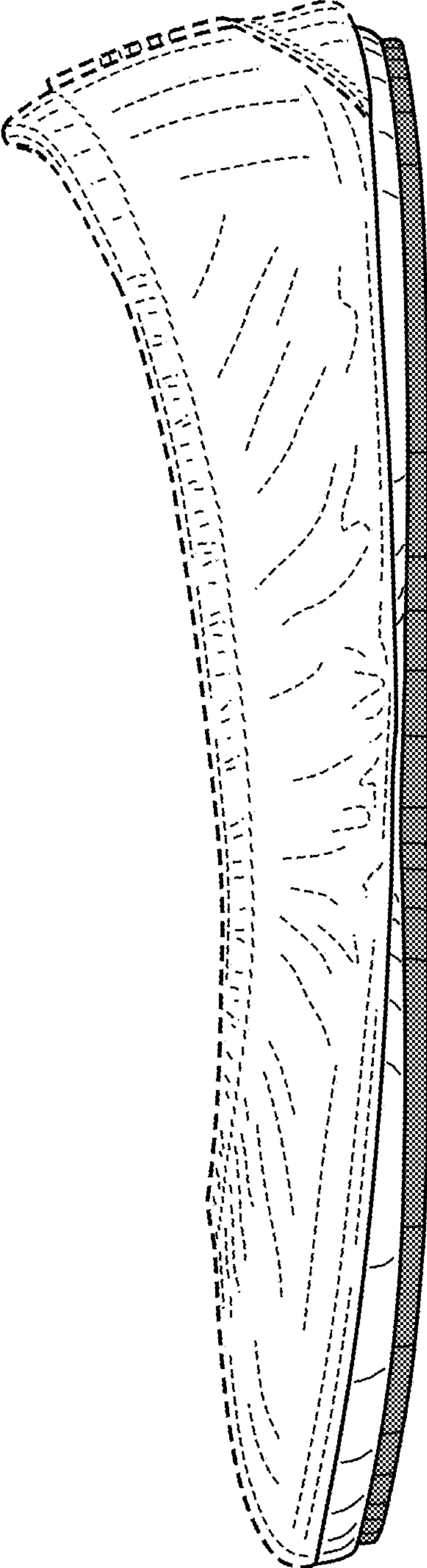

FIG. 3

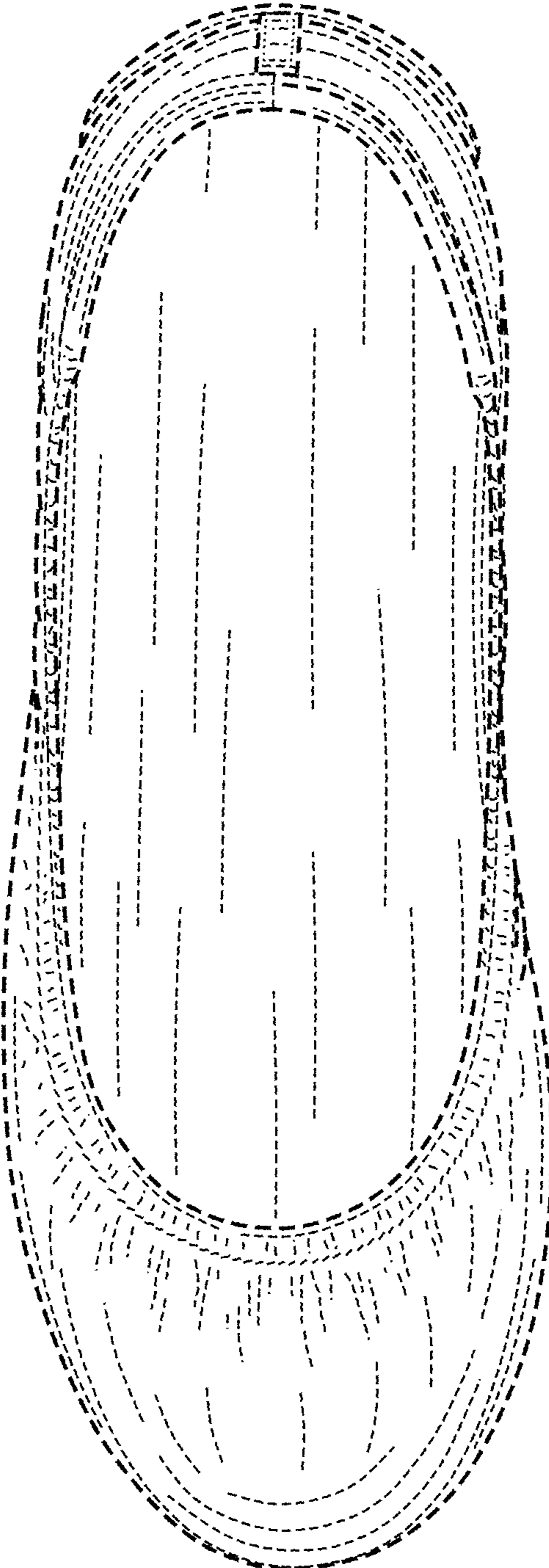

FIG. 4

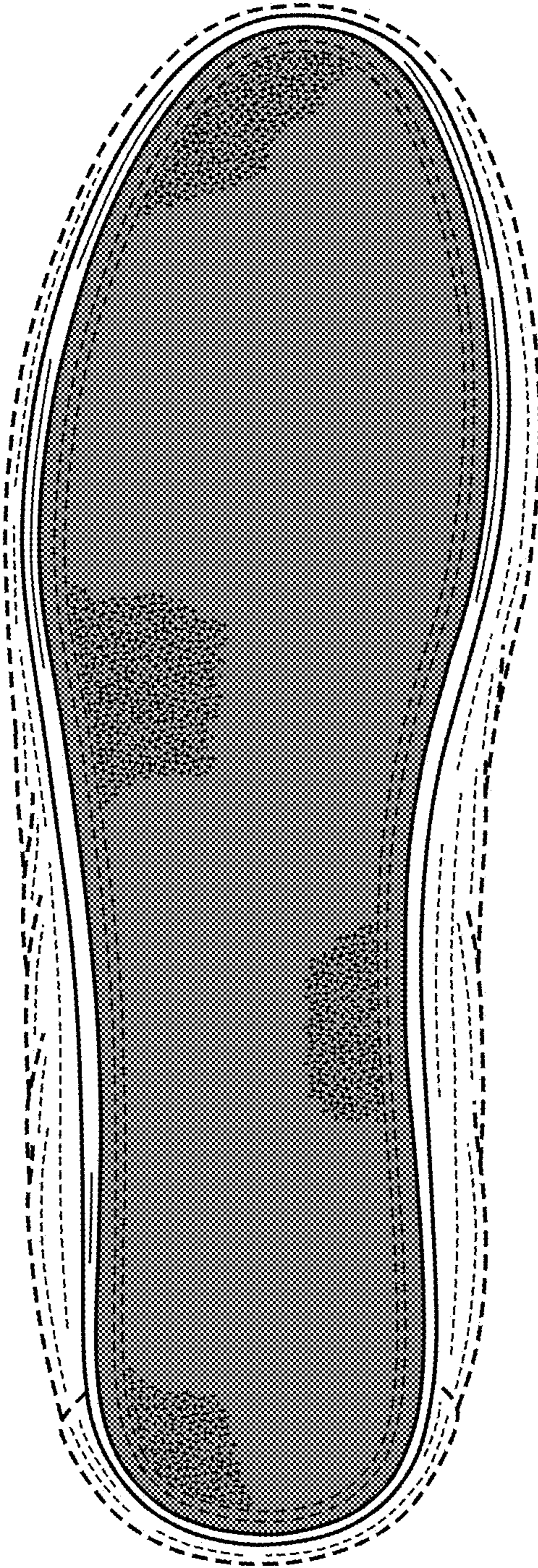

FIG. 5

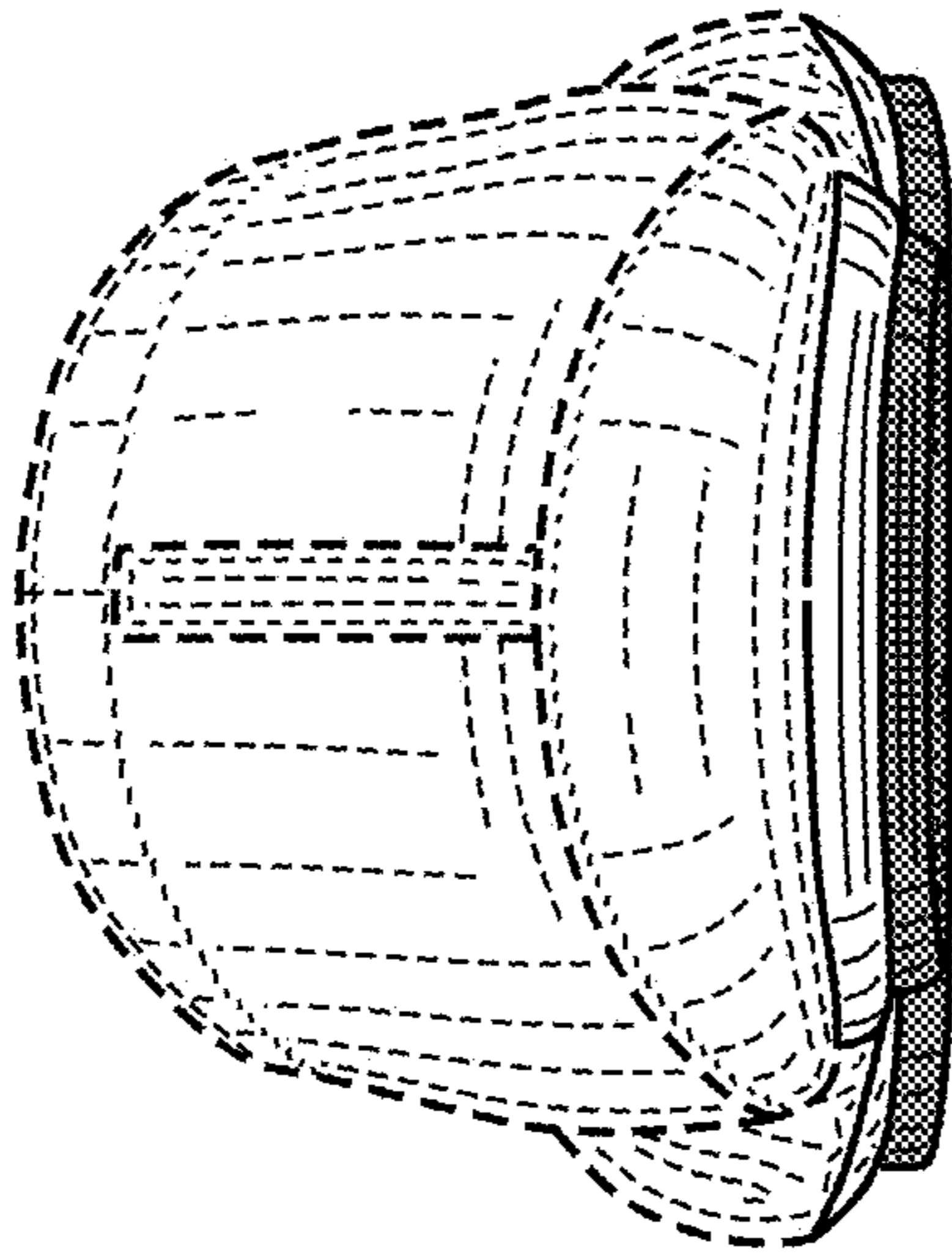

FIG. 7

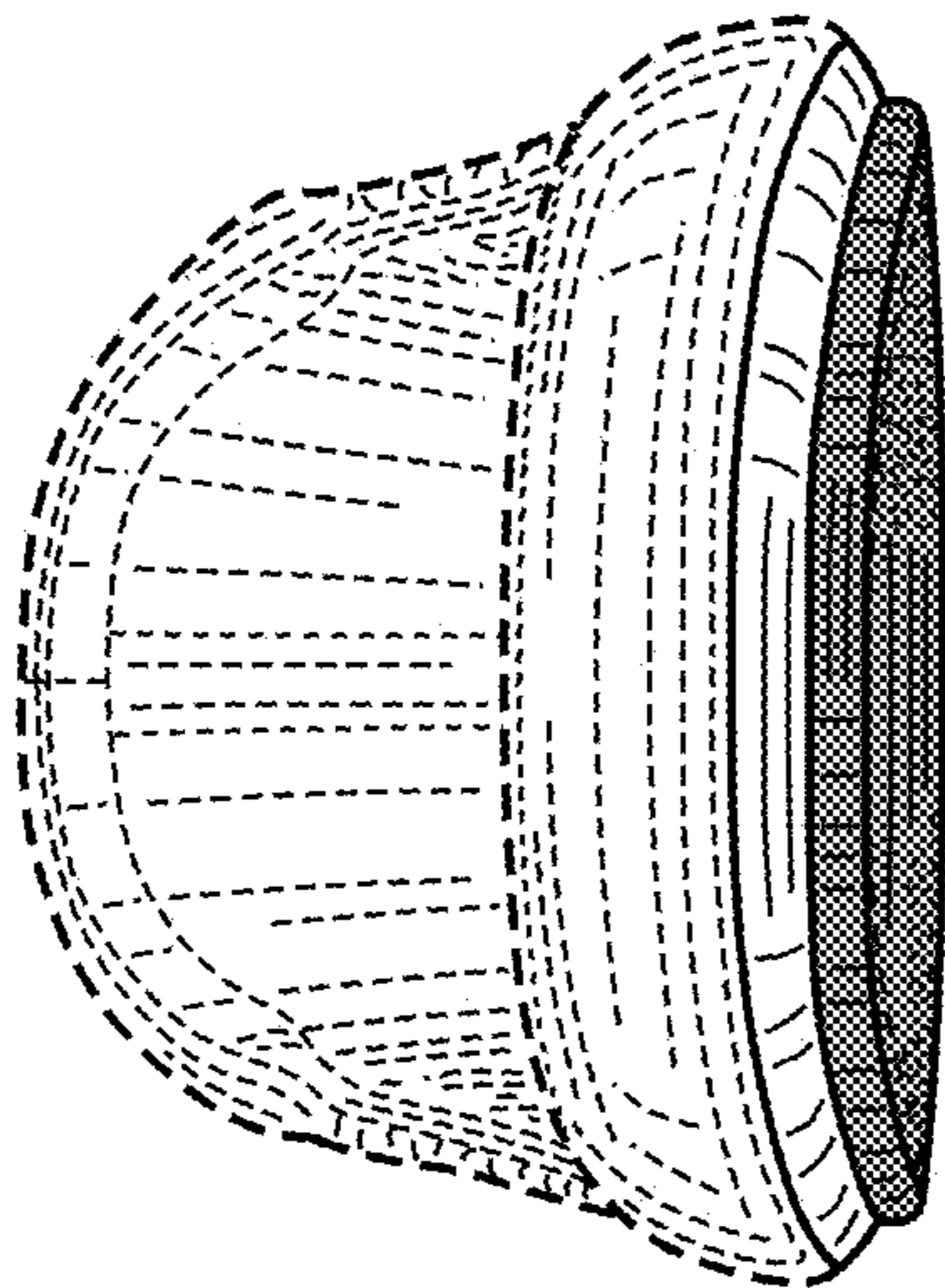

FIG. 6

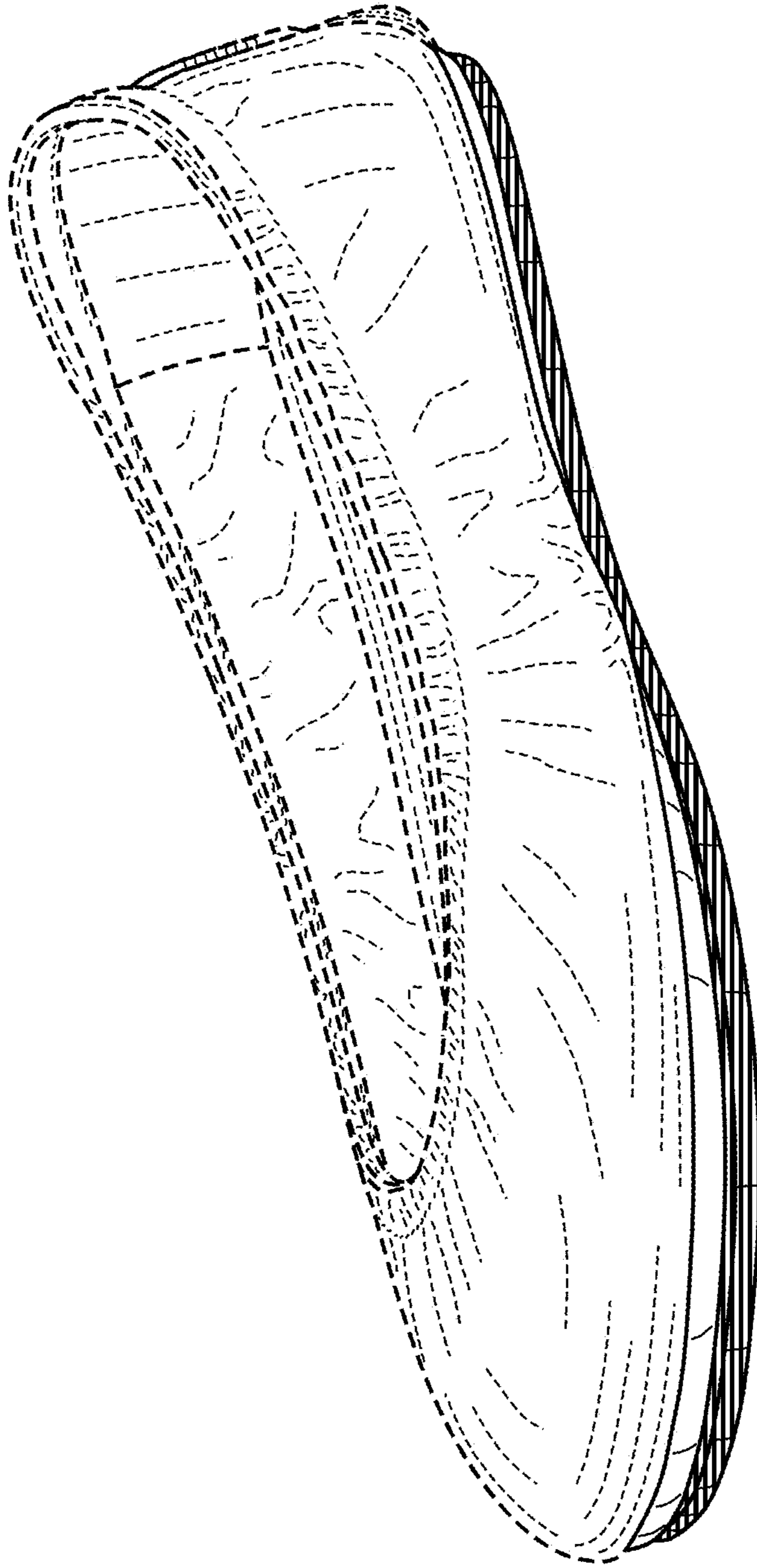

FIG. 8

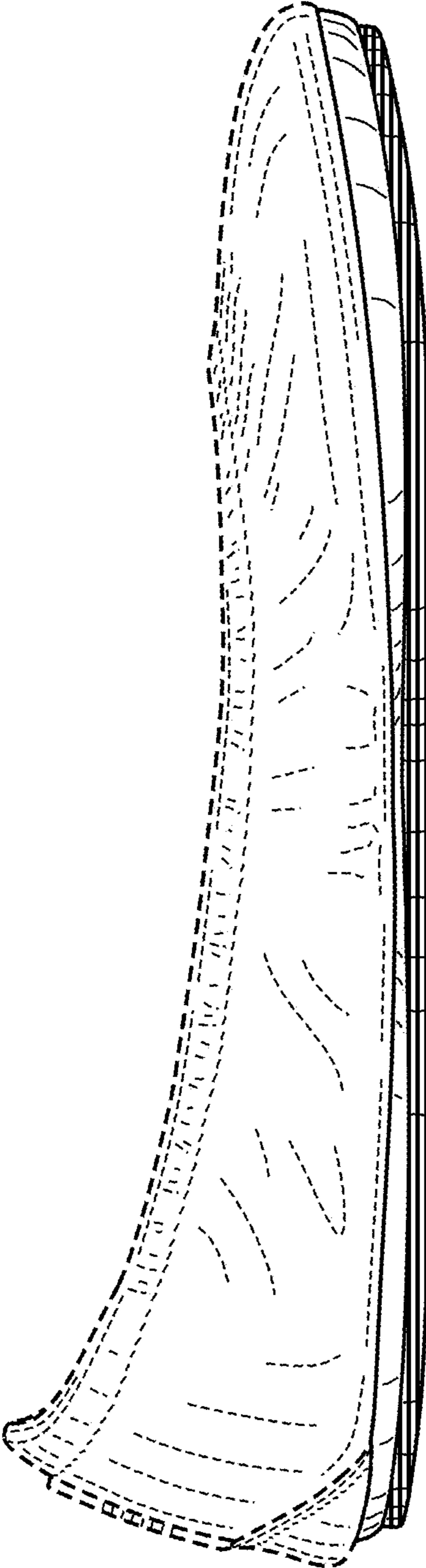

FIG. 9

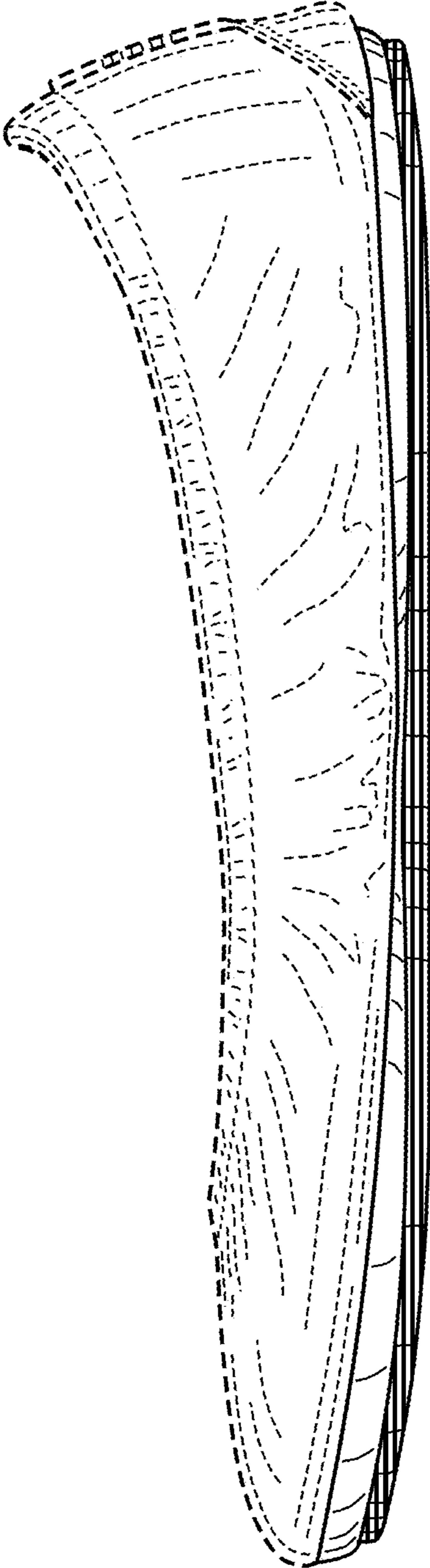

FIG. 10

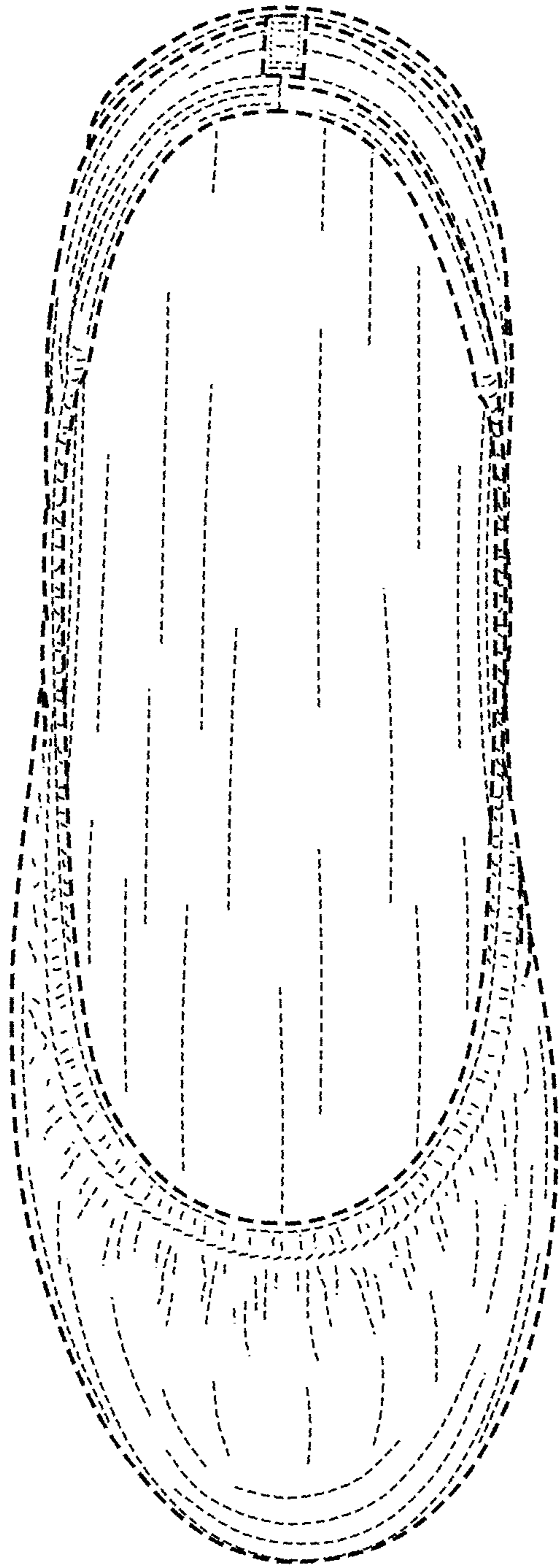

FIG. 11

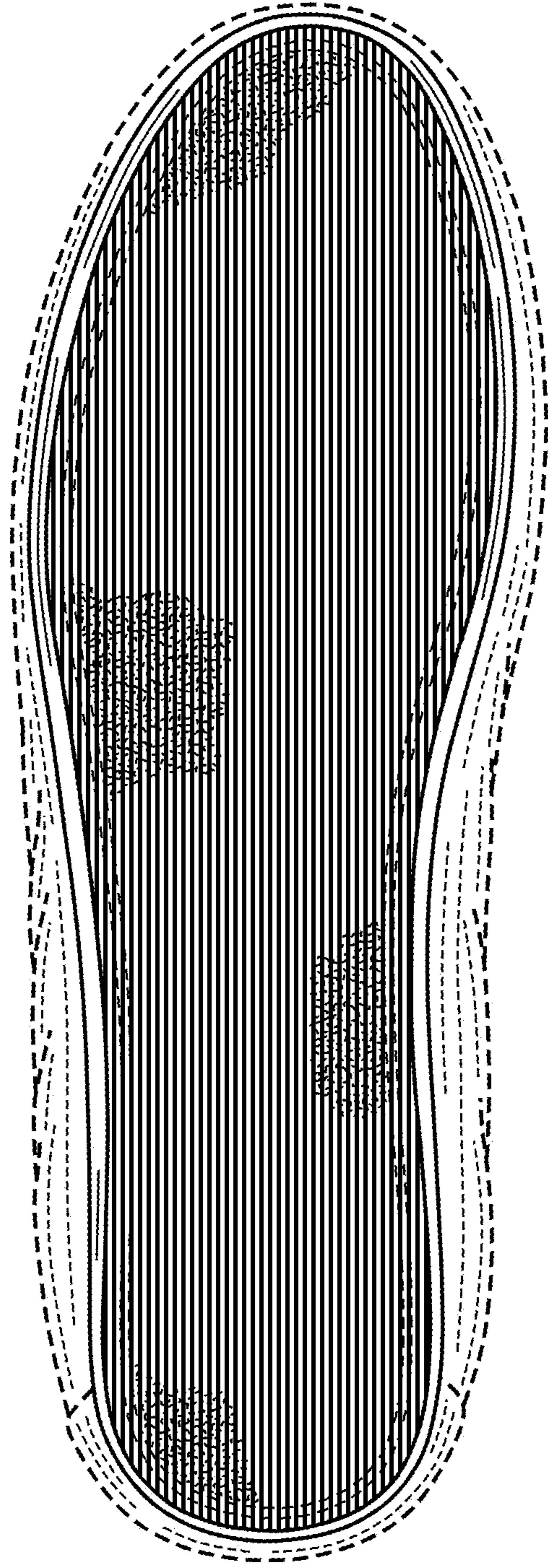

FIG. 12

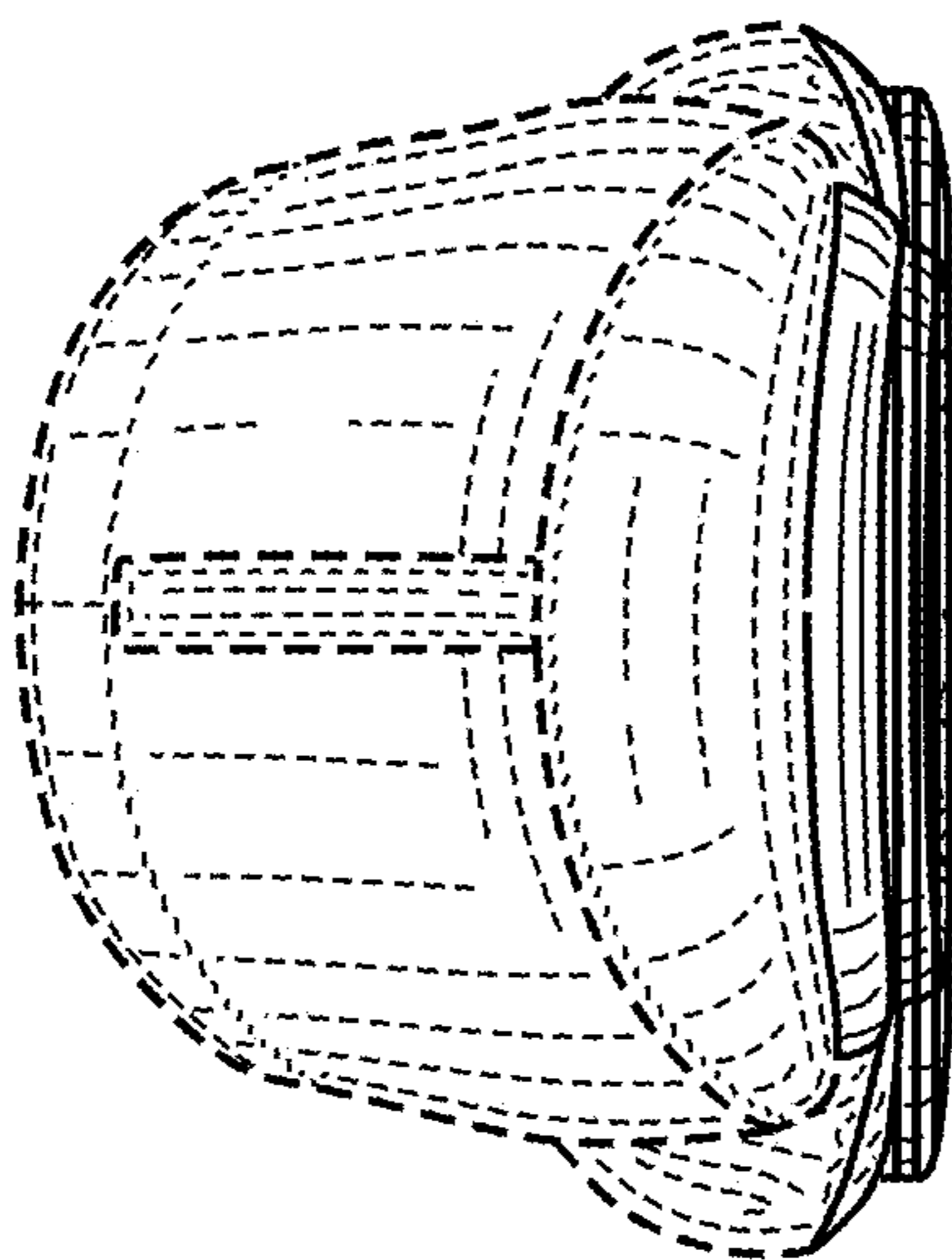

FIG. 14

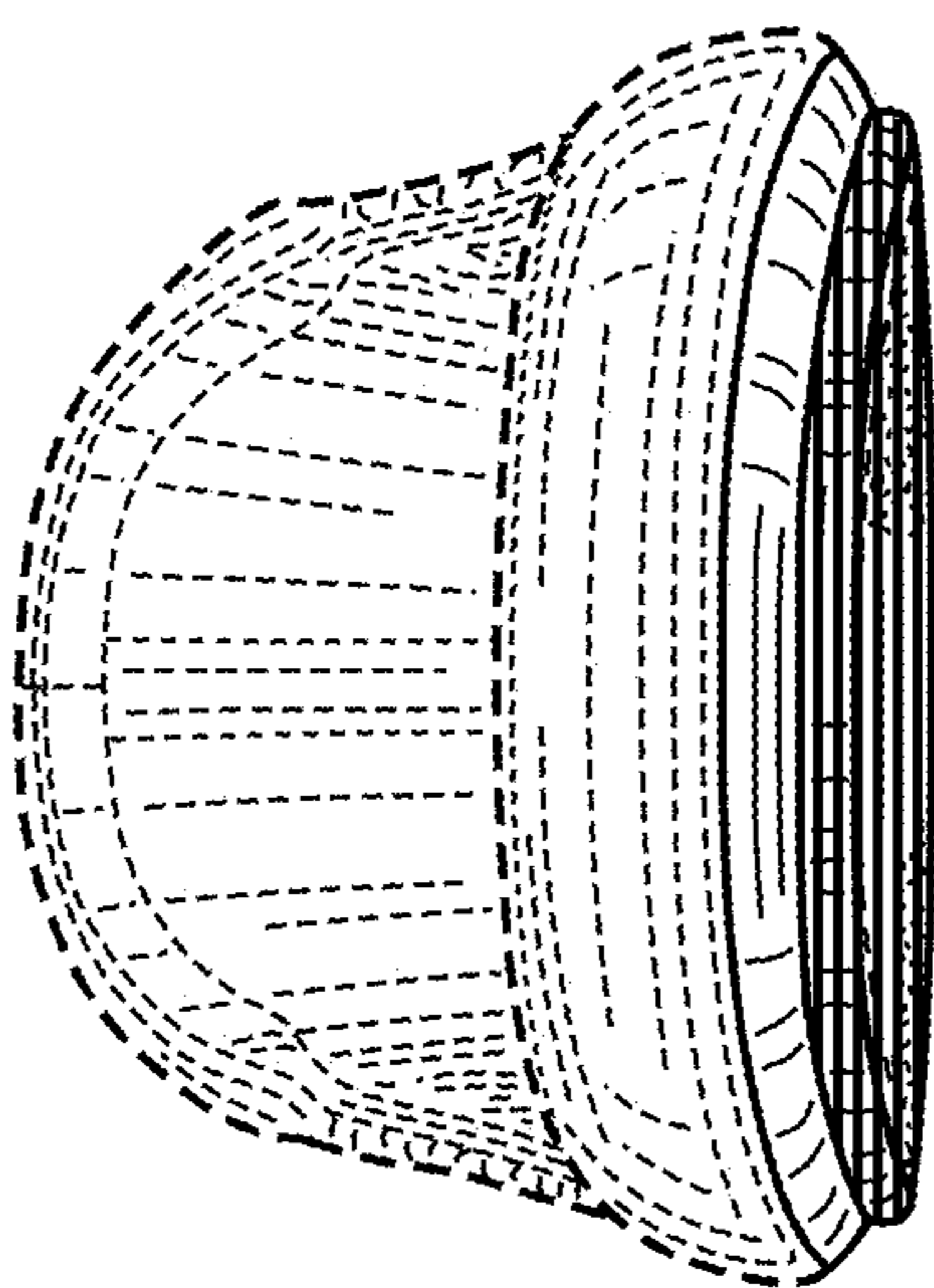

FIG. 13

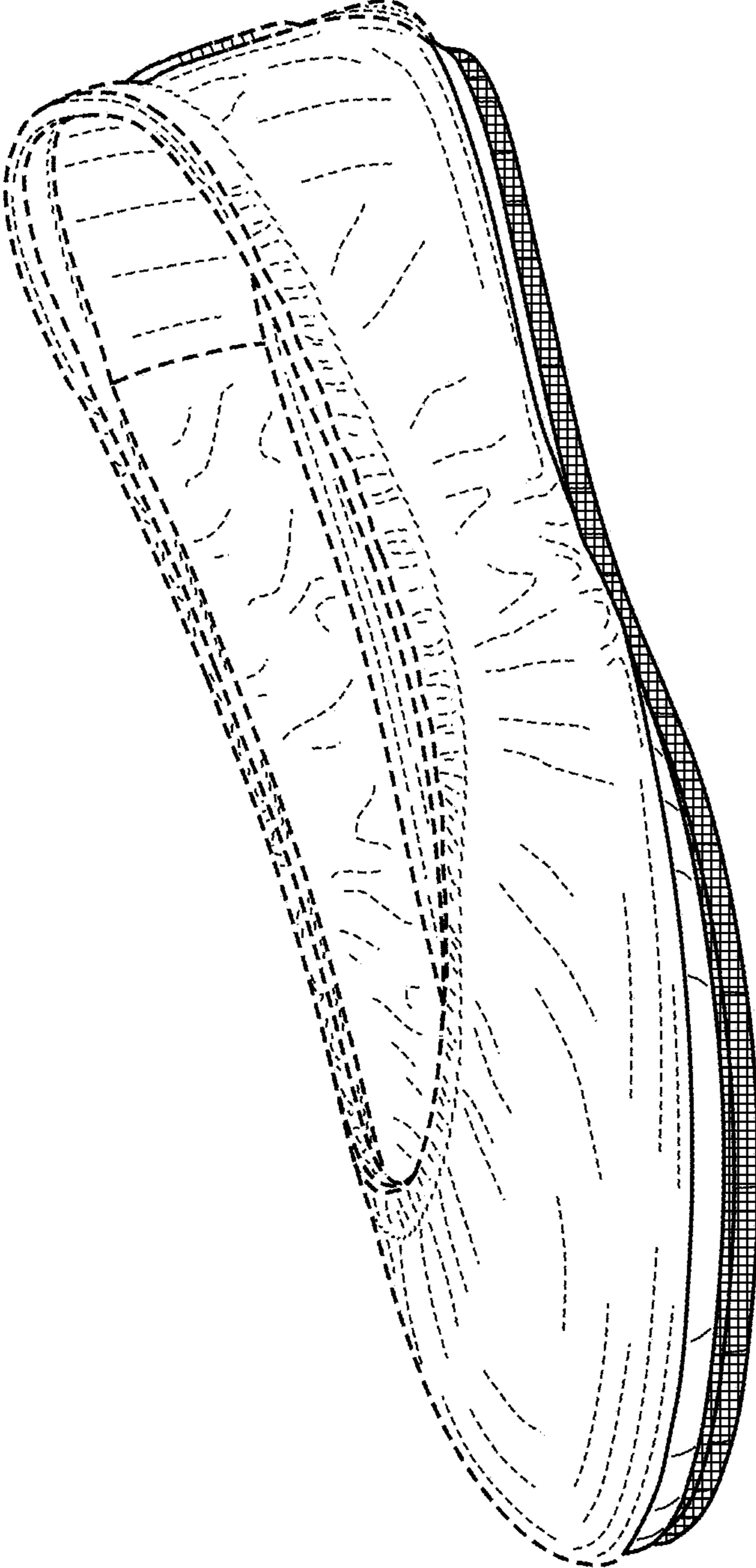

FIG. 15

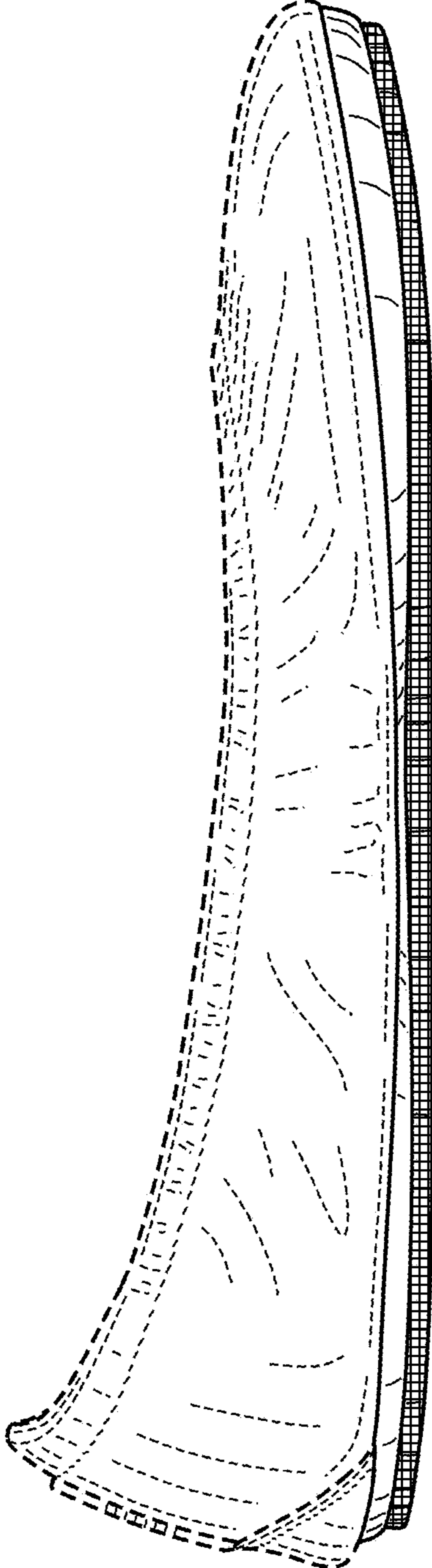

FIG. 16

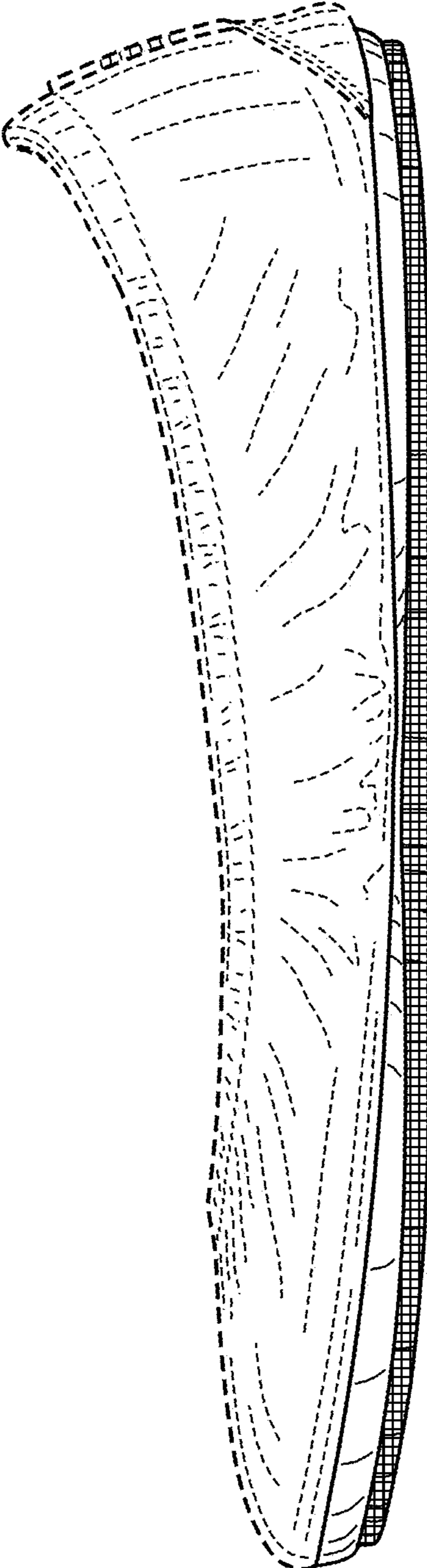

FIG. 17

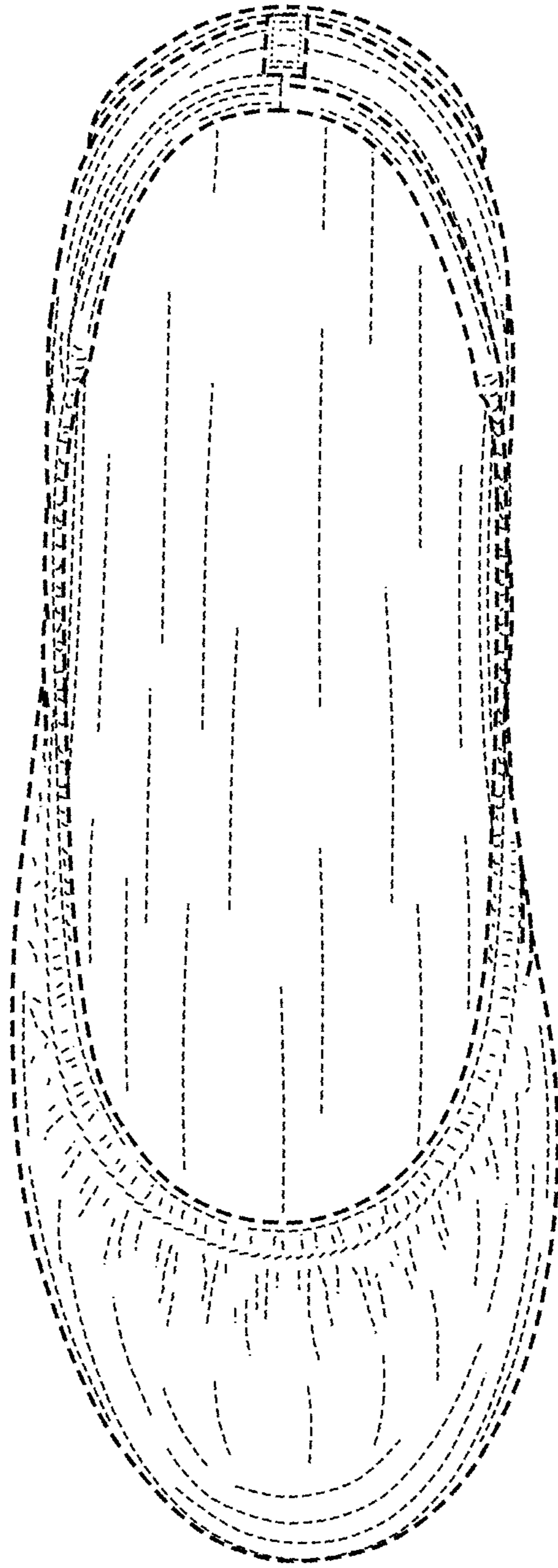

FIG. 18

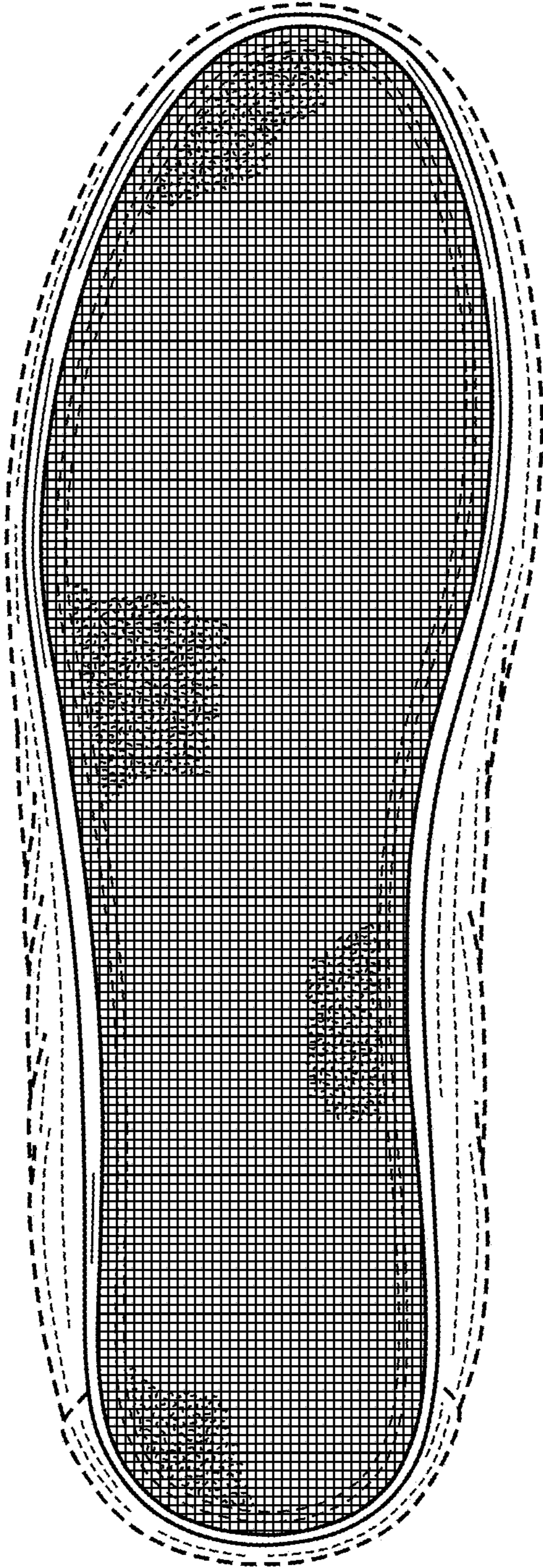

FIG. 19

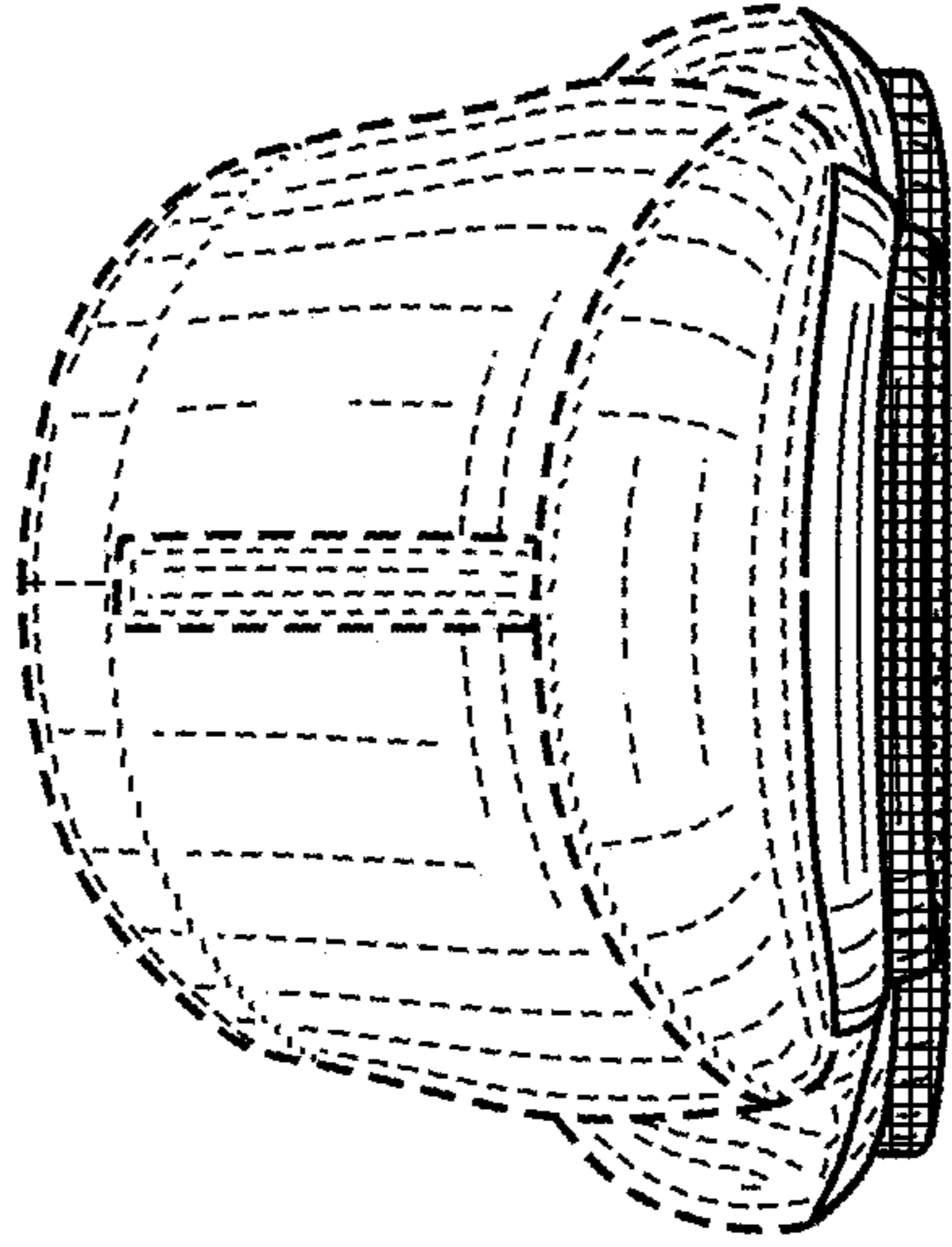

FIG. 21

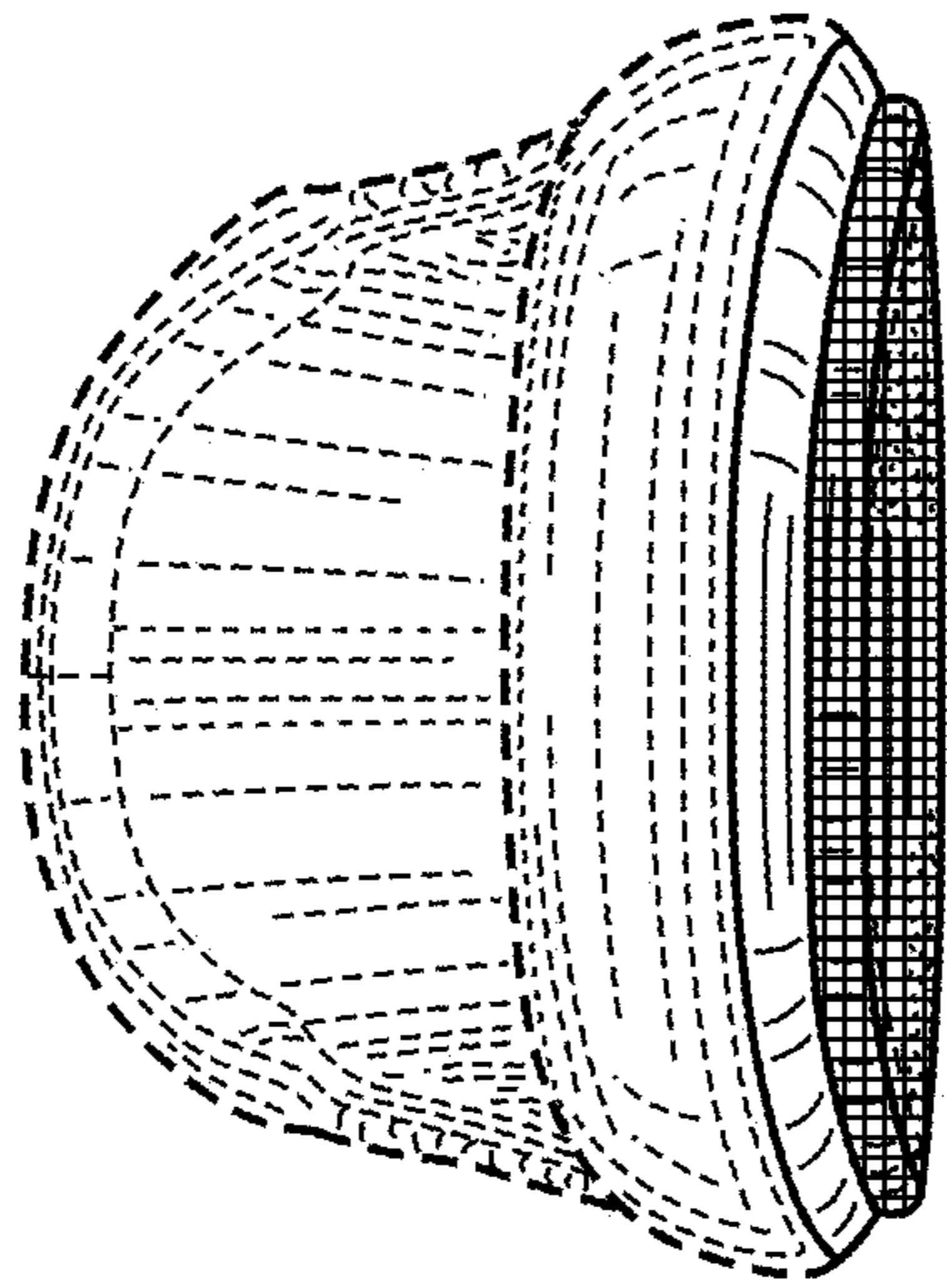

FIG. 20