



US00D825038S

(12) **United States Design Patent** (10) **Patent No.:** **US D825,038 S**  
**Corpuz** (45) **Date of Patent:** **\*\* Aug. 7, 2018**

(54) **SINK**  
(71) Applicant: **Kohler Co.**, Kohler, WI (US)  
(72) Inventor: **Roque Corpuz**, Sheboygan, WI (US)  
(73) Assignee: **KOHLER CO.**, Kohler, WI (US)  
(\*\*) Term: **15 Years**  
(21) Appl. No.: **29/597,269**  
(22) Filed: **Mar. 15, 2017**  
(51) **LOC (11) Cl.** ..... **23-01**  
(52) **U.S. Cl.**  
USPC ..... **D23/293.1**  
(58) **Field of Classification Search**  
USPC ..... D23/284–293.1, 303, 308; D6/329, 573,  
D6/657, 663–666, 671, 671.1, 671.4  
(Continued)

(56) **References Cited**  
U.S. PATENT DOCUMENTS  
D538,900 S \* 3/2007 Bates ..... D23/290  
D592,292 S \* 5/2009 Kakihana ..... D23/293.1  
(Continued)

*Primary Examiner* — Lakiya G Rogers  
*Assistant Examiner* — John A Voytek  
(74) *Attorney, Agent, or Firm* — Foley & Lardner LLP

(57) **CLAIM**  
I claim the ornamental design for a sink, as shown and described.

**DESCRIPTION**

FIG. 1 is a top, front, right perspective view of an embodiment of the claimed design;  
FIG. 2 is a front elevation view thereof;  
FIG. 3 is a rear elevation view thereof;

FIG. 4 is a left side elevation view thereof;  
FIG. 5 is a right side elevation view thereof;  
FIG. 6 is a top plan view thereof;  
FIG. 7 is a bottom plan view thereof;  
FIG. 8 is a cross-sectional view thereof taken across line 8-8 of FIG. 6;  
FIG. 9 is a cross-sectional view thereof taken across line 9-9 of FIG. 6;  
FIG. 10 is a cross-sectional view thereof taken across line 10-10 of FIG. 6;  
FIG. 11 is a cross-sectional view thereof taken across line 11-11 of FIG. 6;  
FIG. 12 is a cross-sectional view thereof taken across line 12-12 of FIG. 6;  
FIG. 13 is a cross-sectional view thereof taken across line 13-13 of FIG. 6;  
FIG. 14 is a top, front, right perspective view of another embodiment of the claimed design;  
FIG. 15 is a front elevation view thereof;  
FIG. 16 is a rear elevation view thereof;  
FIG. 17 is a left side elevation view thereof;  
FIG. 18 is a right side elevation view thereof;  
FIG. 19 is a top plan view thereof;  
FIG. 20 is a bottom plan view thereof;  
FIG. 21 is a cross-sectional view thereof taken across line 21-21 of FIG. 19;  
FIG. 22 is a cross-sectional view thereof taken across line 22-22 of FIG. 19;  
FIG. 23 is a cross-sectional view thereof taken across line 23-23 of FIG. 19;  
FIG. 24 is a cross-sectional view thereof taken across line 24-24 of FIG. 19;  
FIG. 25 is a cross-sectional view thereof taken across line 25-25 of FIG. 19; and,  
FIG. 26 is a cross-sectional view thereof taken across line 26-26 of FIG. 19.

In the drawings, the broken lines depict environmental subject matter only and form no part of the claimed design. The dot and dashed lines indicate a boundary between the claimed and unclaimed portion of the design.

**1 Claim, 14 Drawing Sheets**

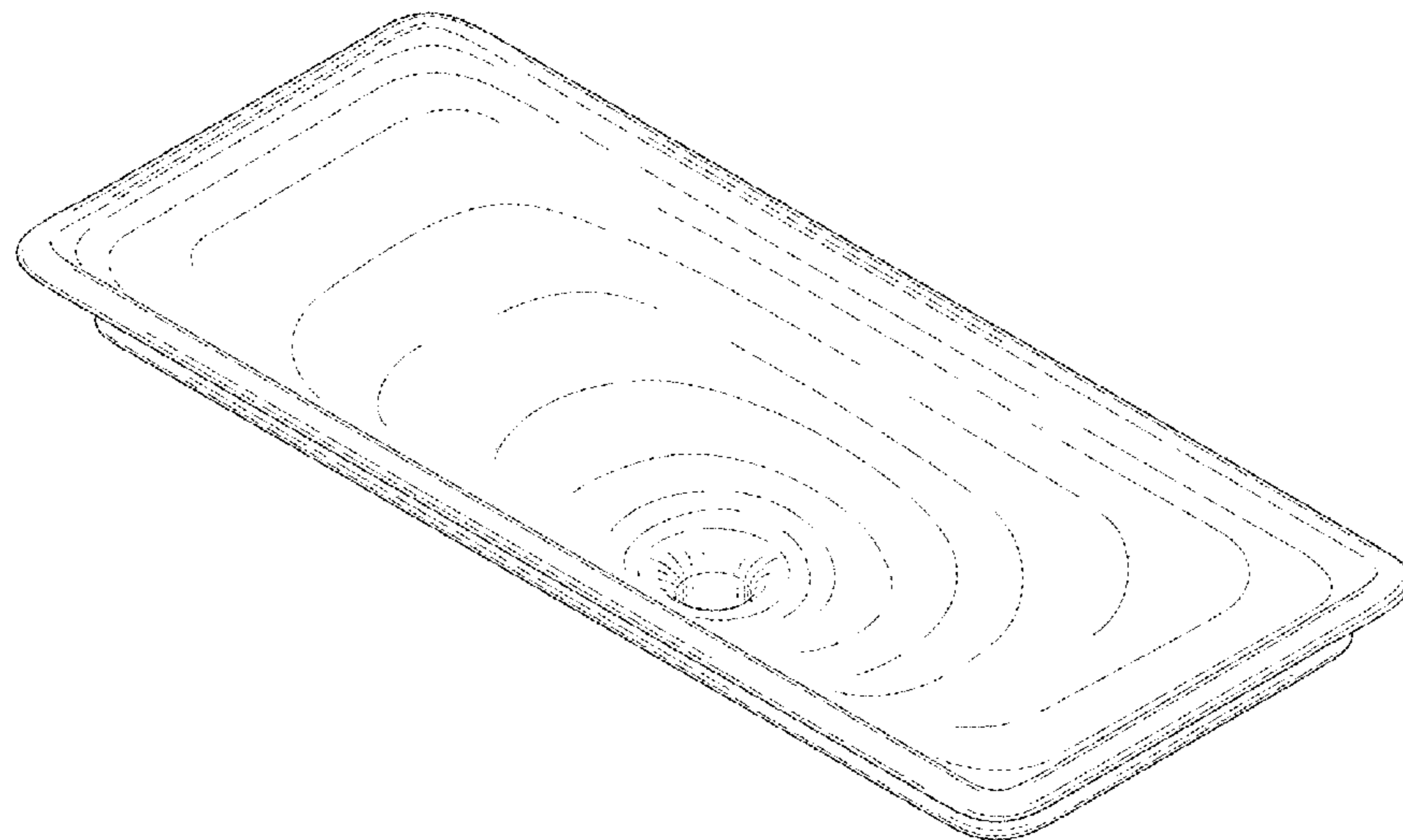

(58) **Field of Classification Search**

CPC ..... A47K 1/04; A47B 77/06; A47J 47/20

See application file for complete search history.

(56) **References Cited**

U.S. PATENT DOCUMENTS

D678,991 S	3/2013	Stauffer	
D687,529 S	8/2013	Stauffer	
D722,143 S	2/2015	Clarke et al.	
D752,726 S *	3/2016	Clarke .....	D23/293.1
D765,229 S	8/2016	Stauffer et al.	
D767,741 S *	9/2016	Clarke .....	D23/293.1
D779,643 S *	2/2017	Stauffer .....	D23/284

\* cited by examiner

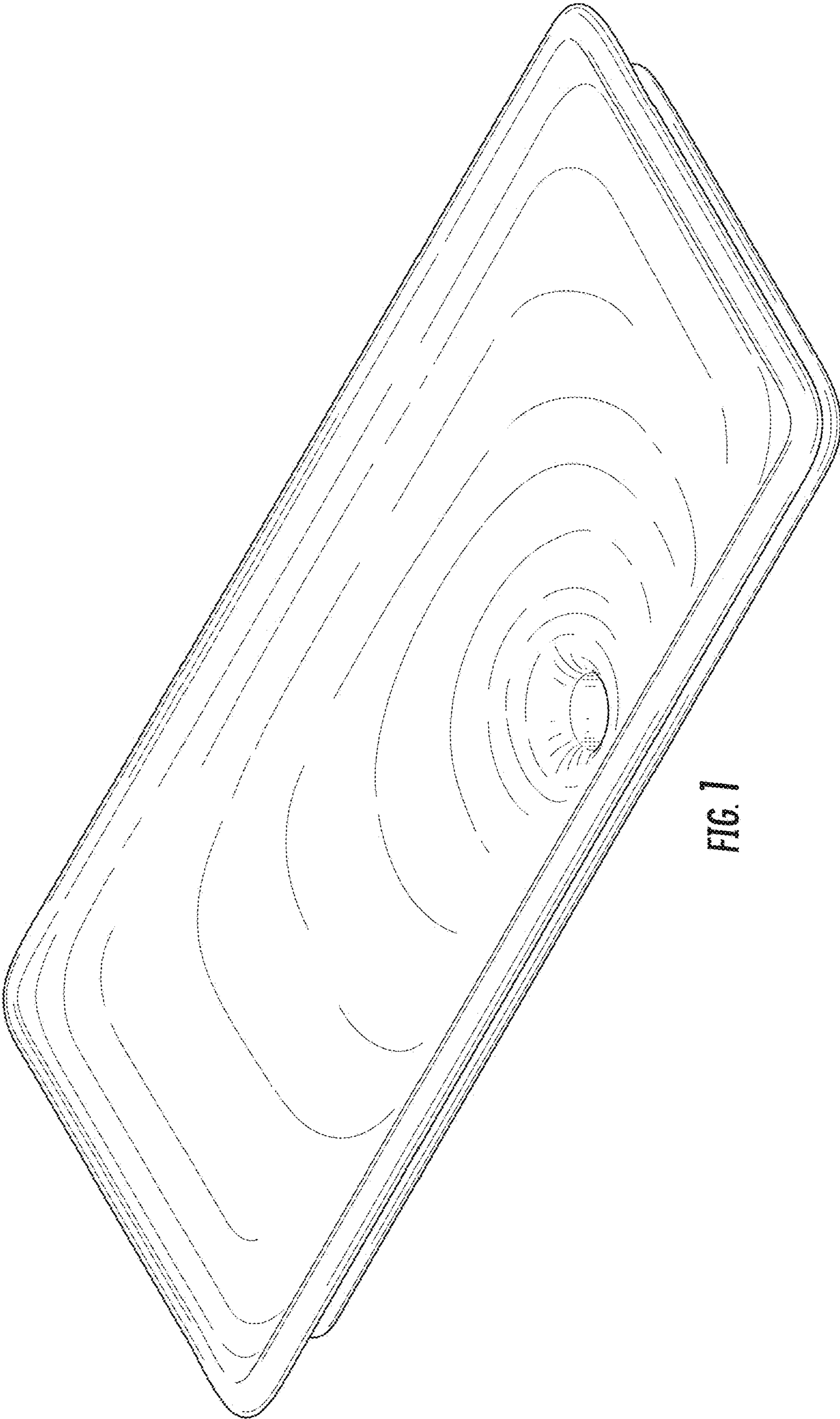

FIG. 1

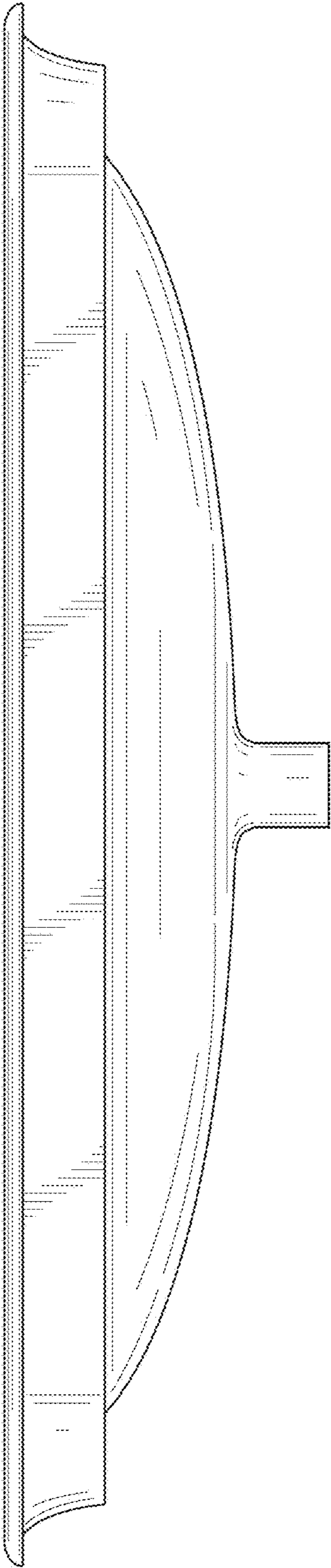

FIG. 2

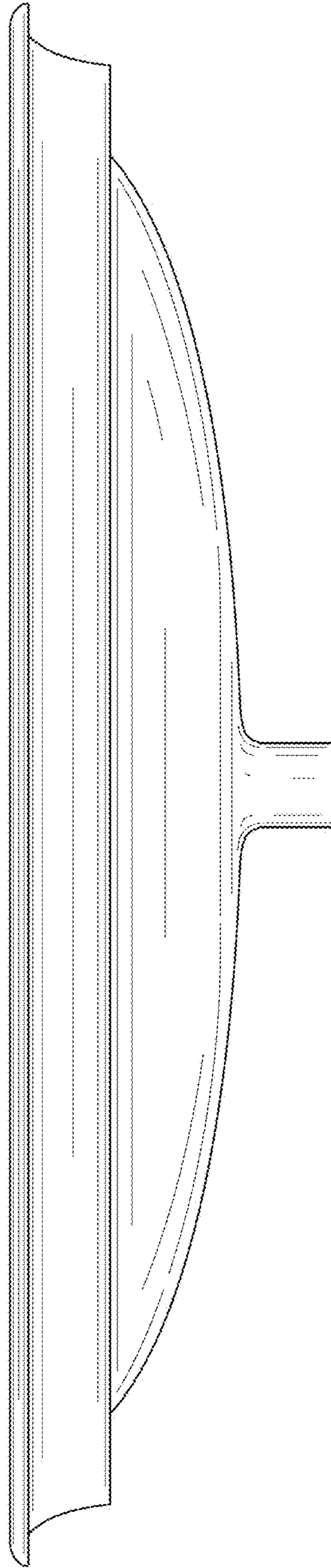

FIG. 3

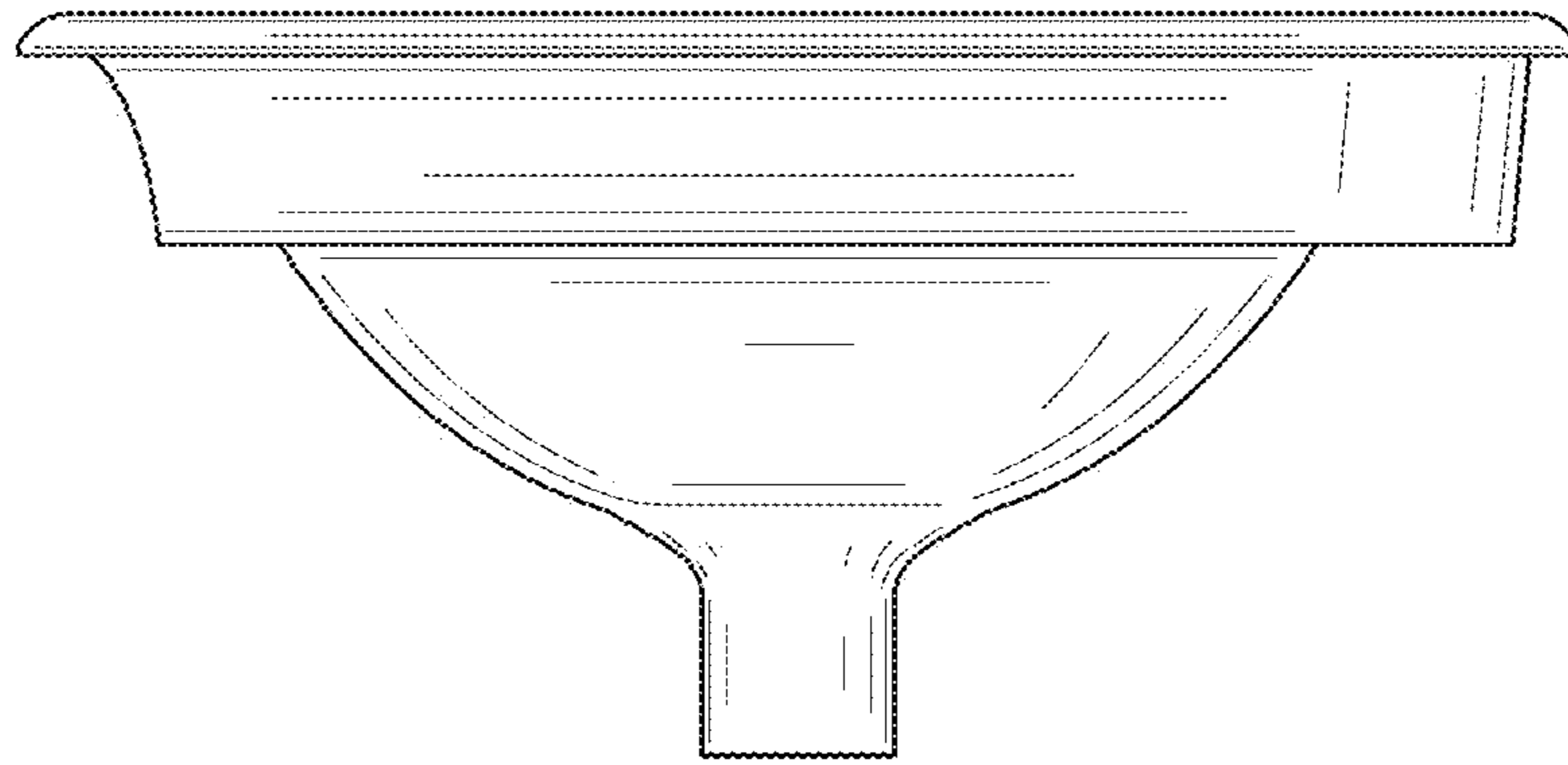

FIG. 4

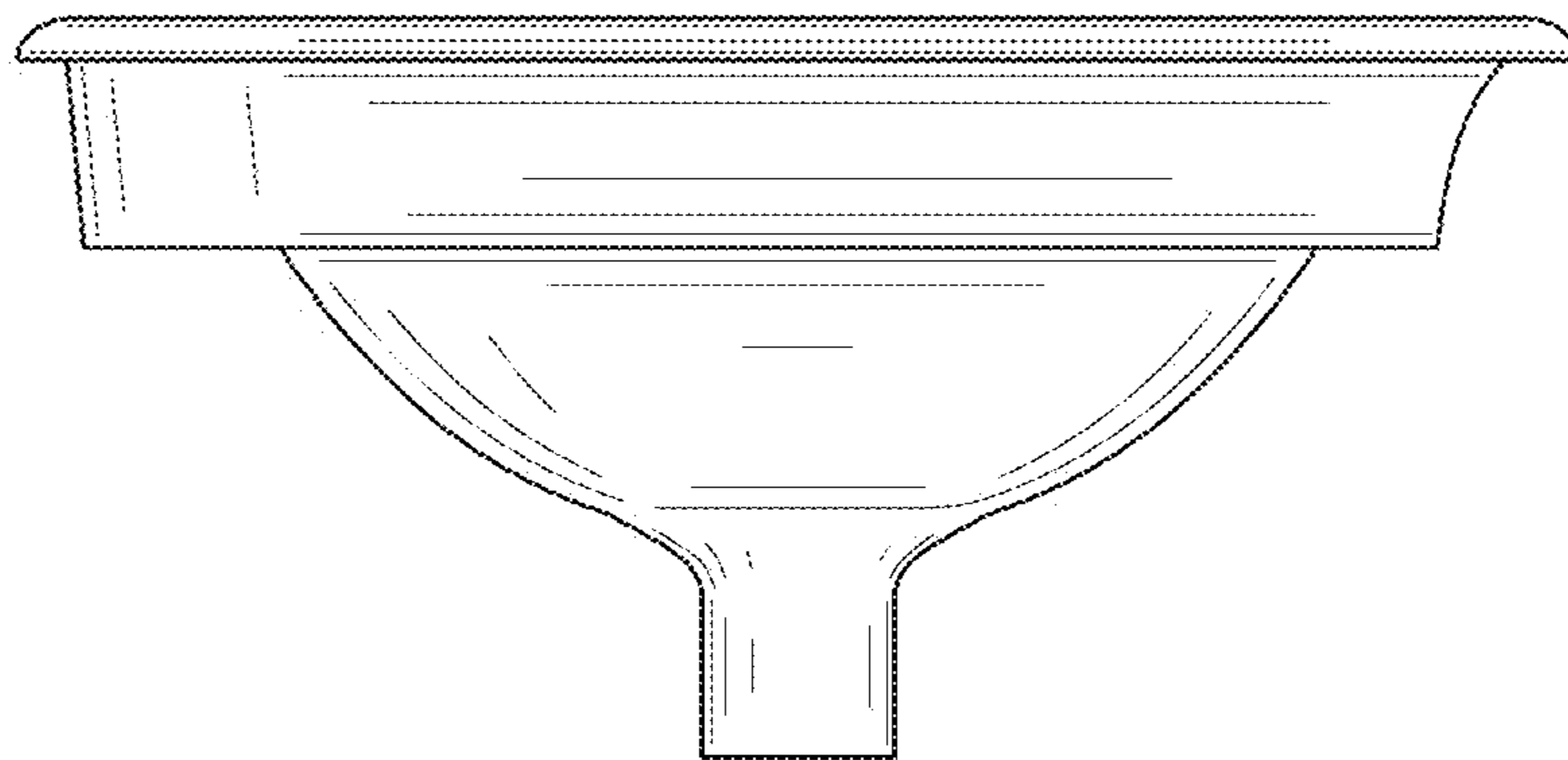

FIG. 5

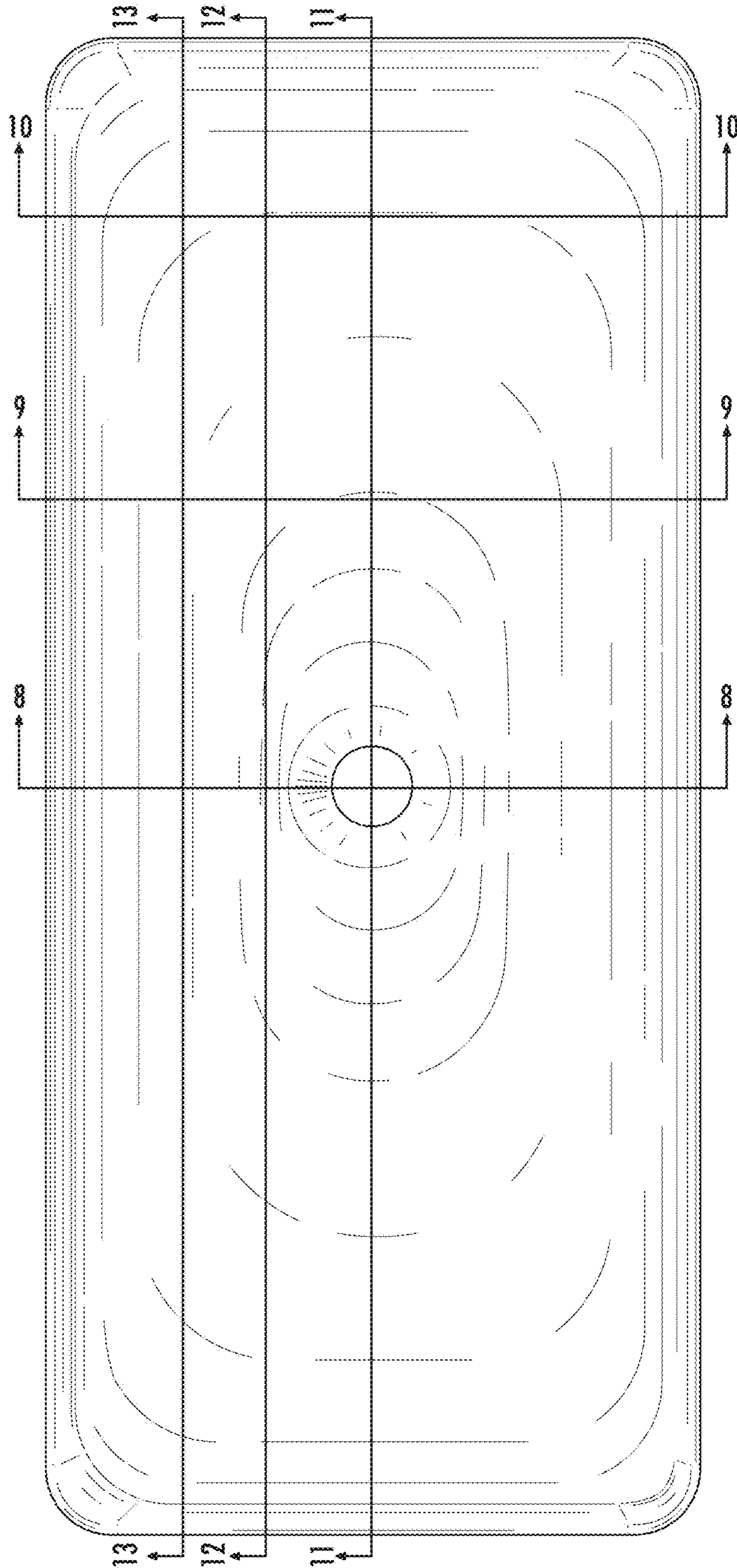

FIG. 6

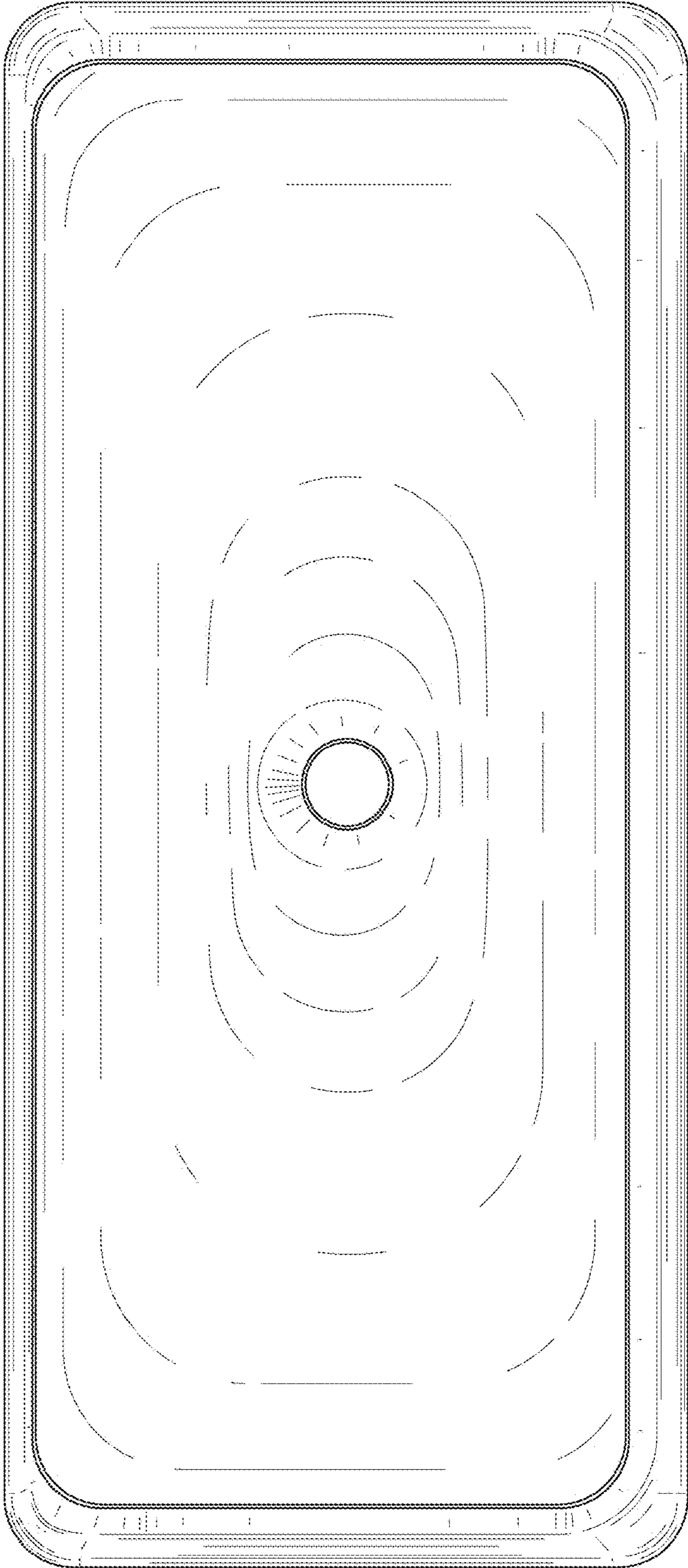
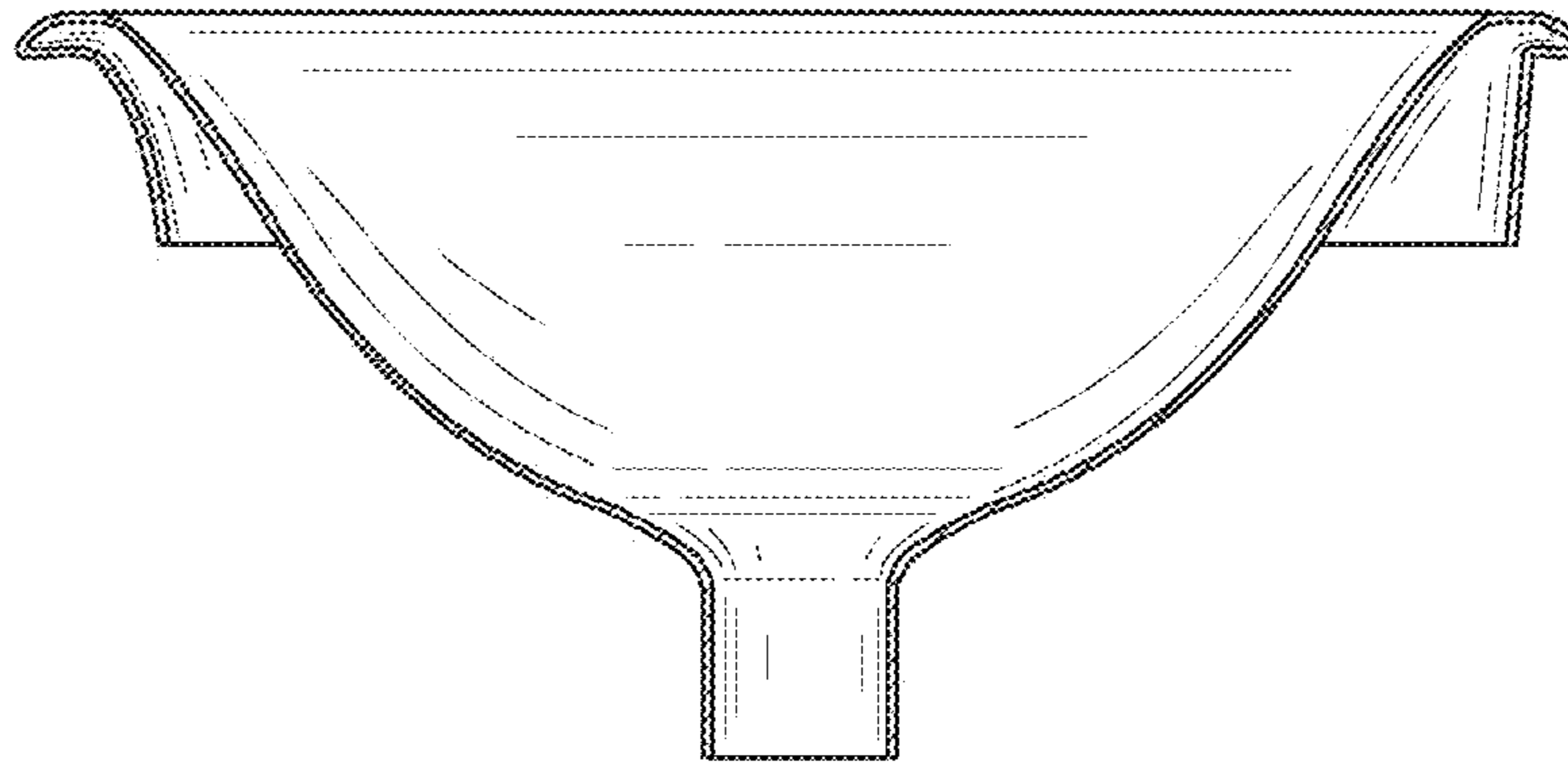
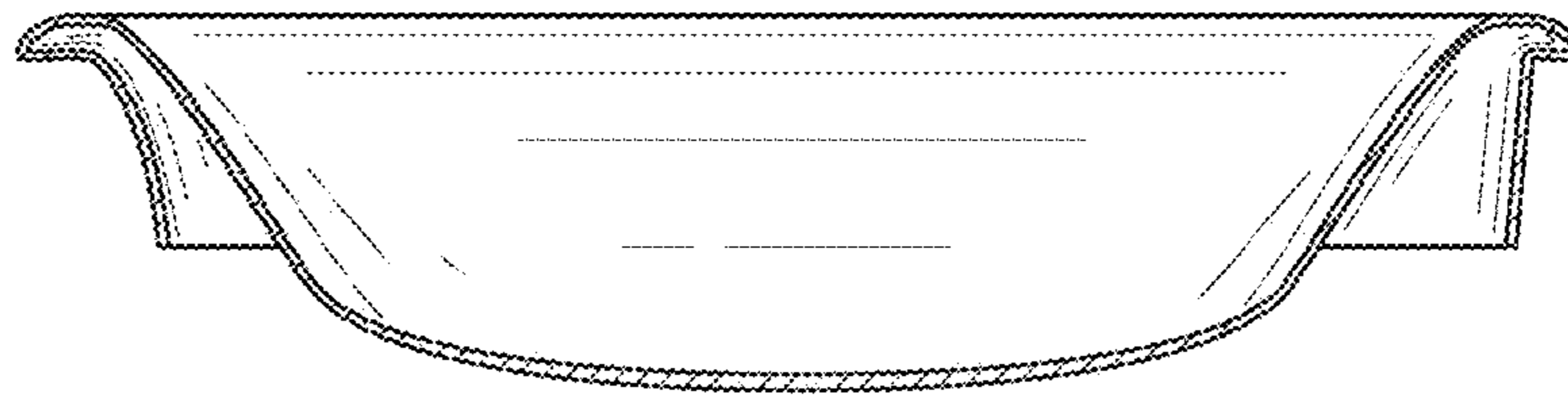

FIG. 7



**FIG. 8**



**FIG. 9**

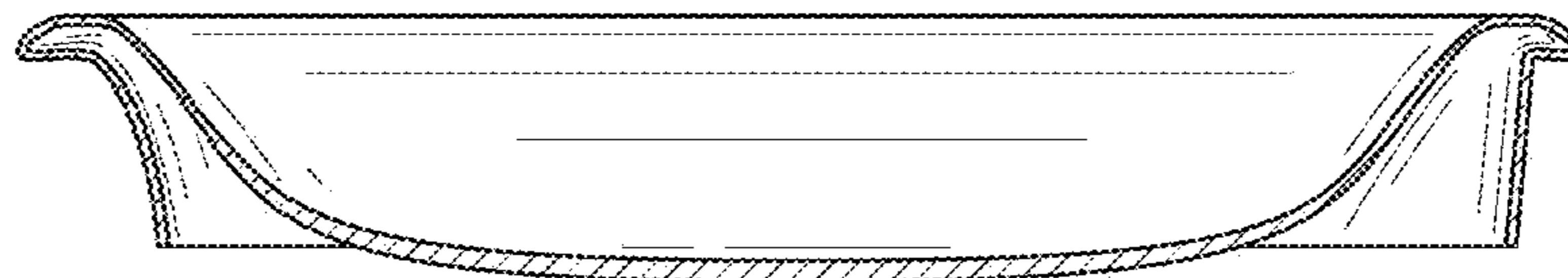

**FIG. 10**



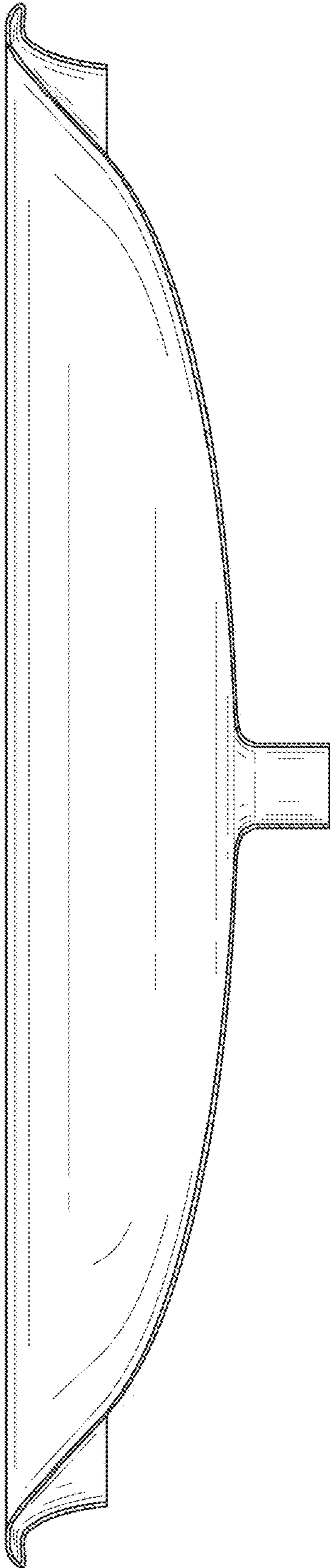

FIG. 11

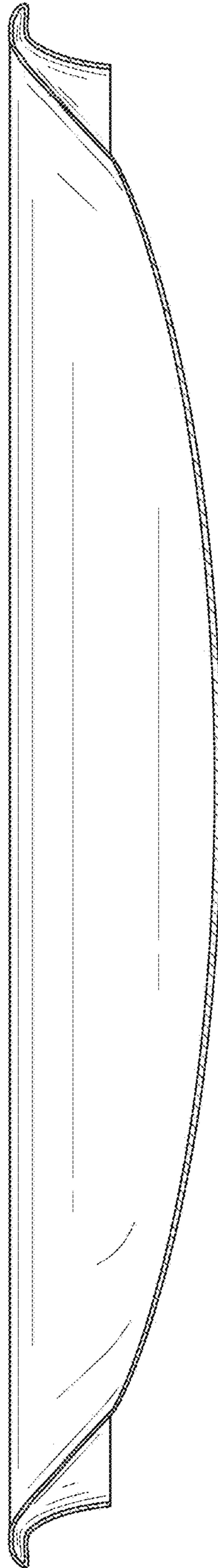

FIG. 12

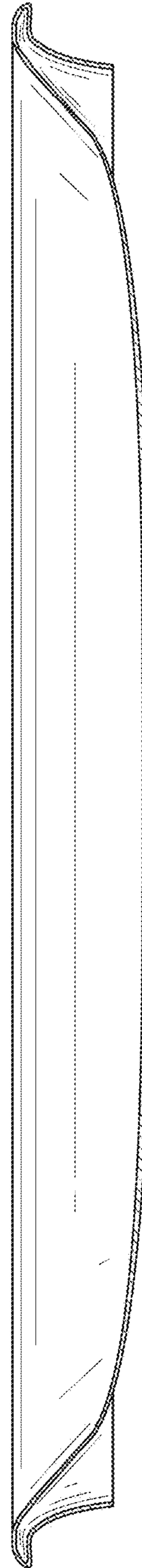

FIG. 13

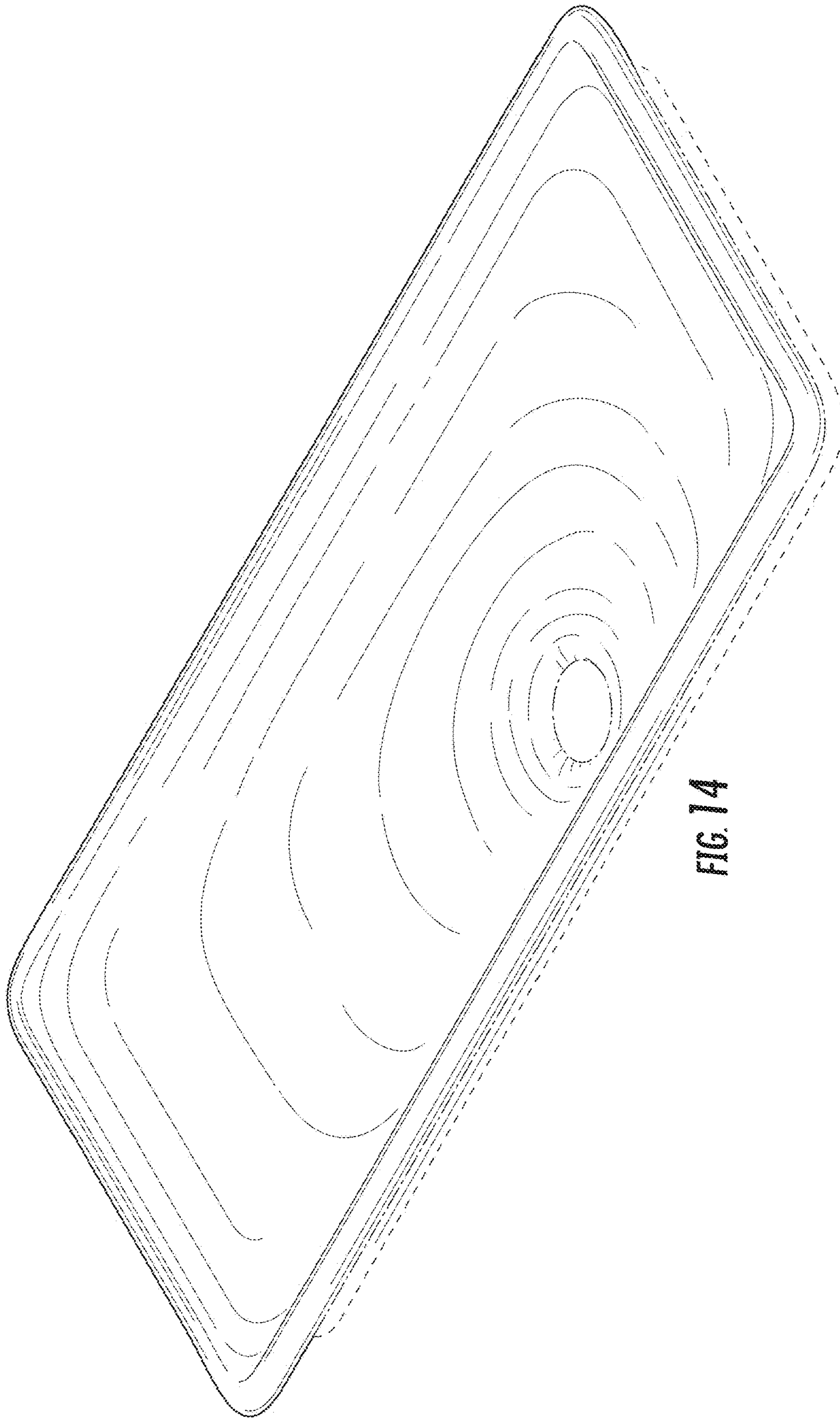

FIG. 14

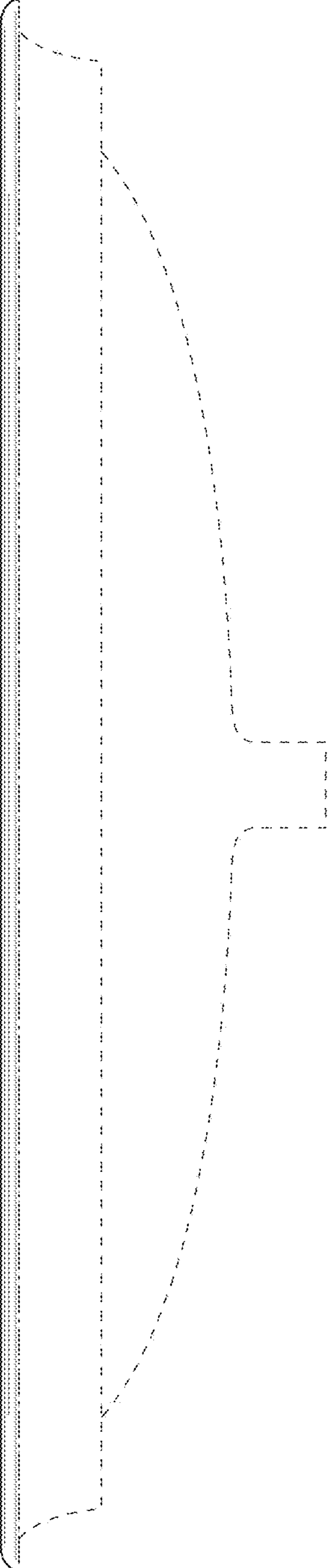

FIG. 15

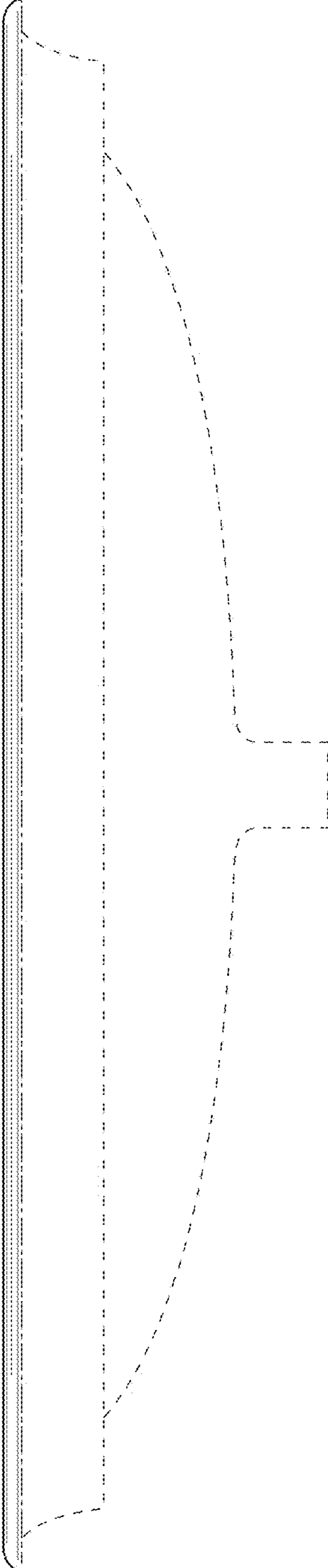
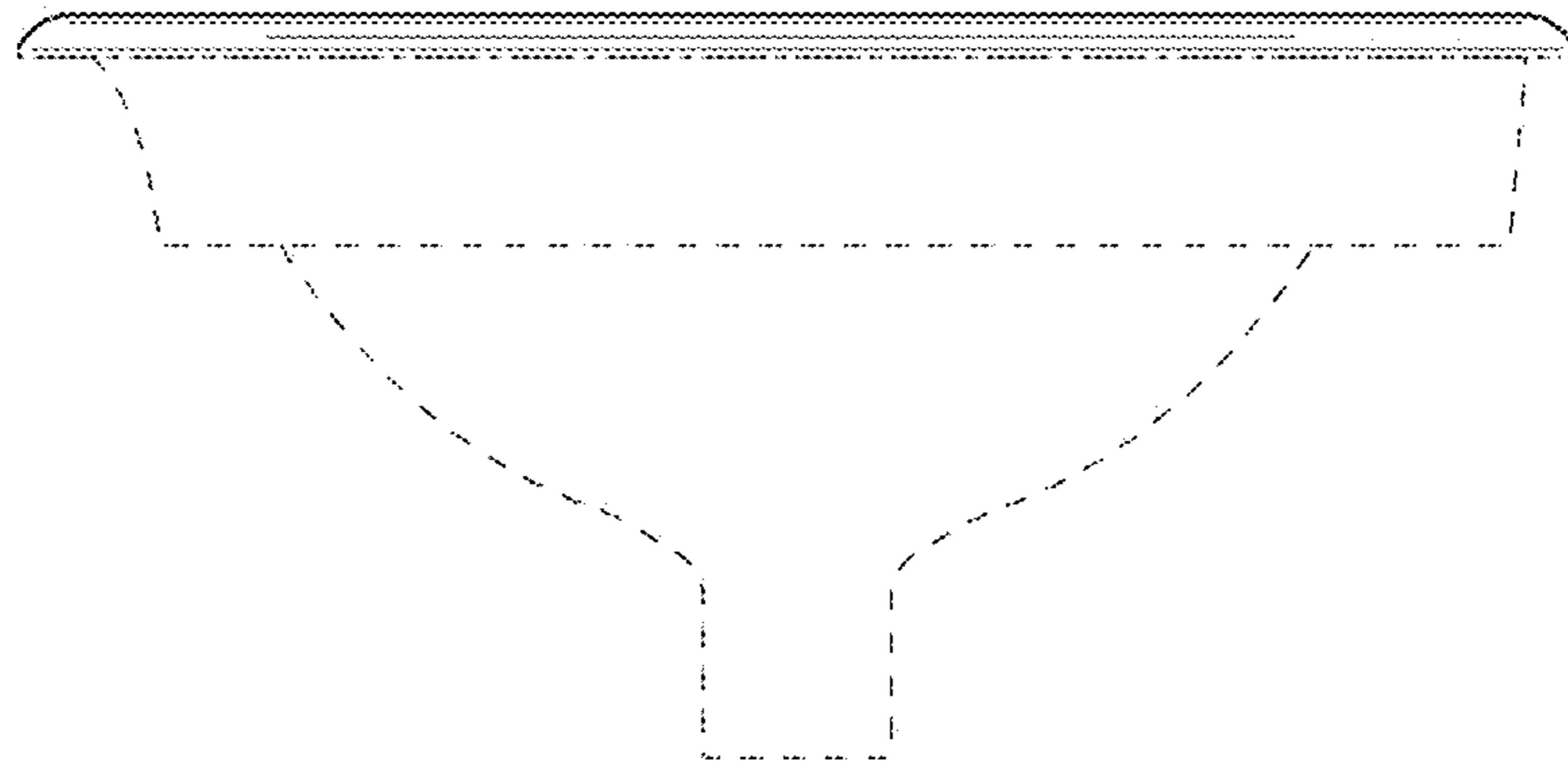
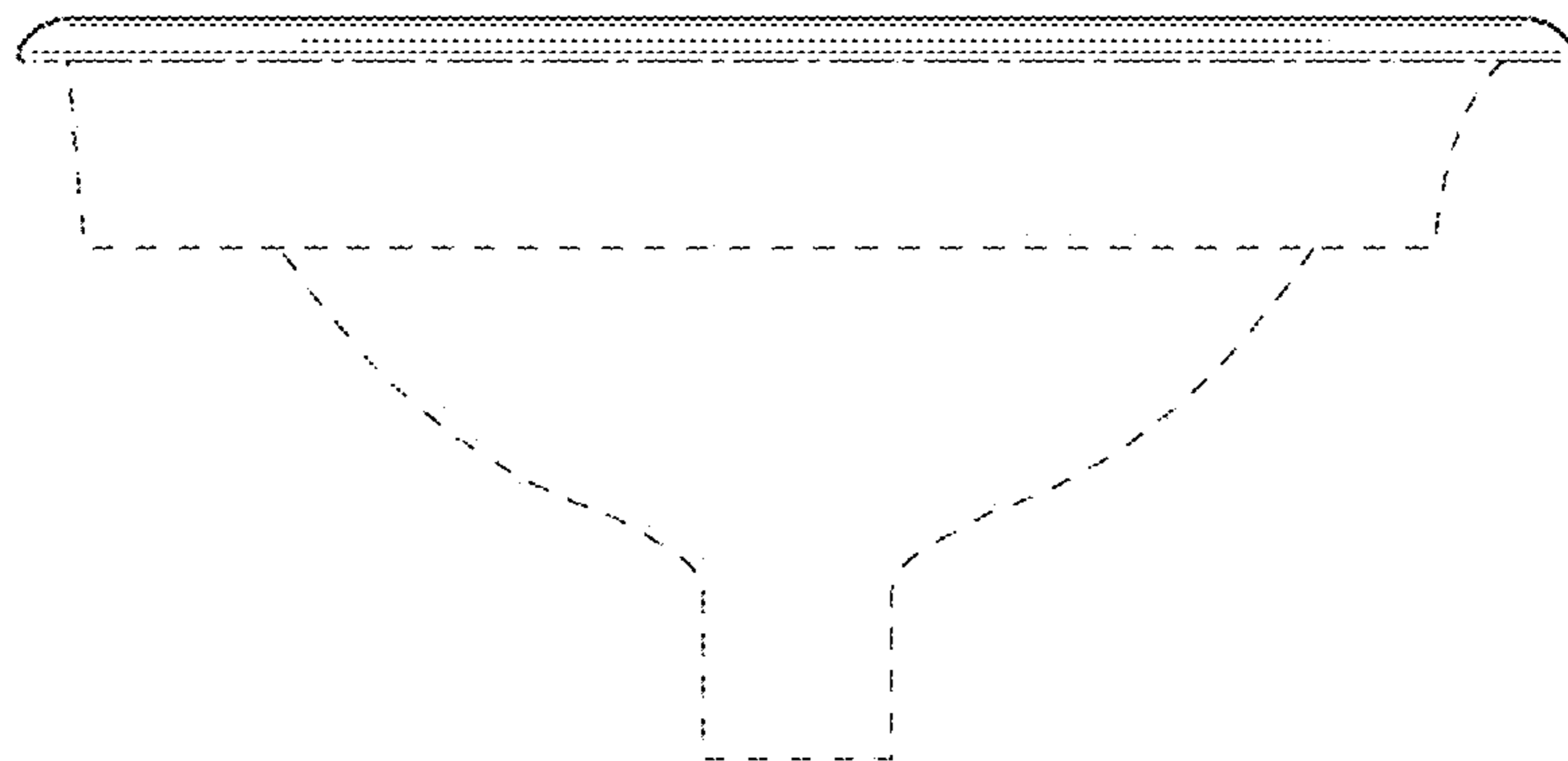

FIG. 16



**FIG. 17**



**FIG. 18**

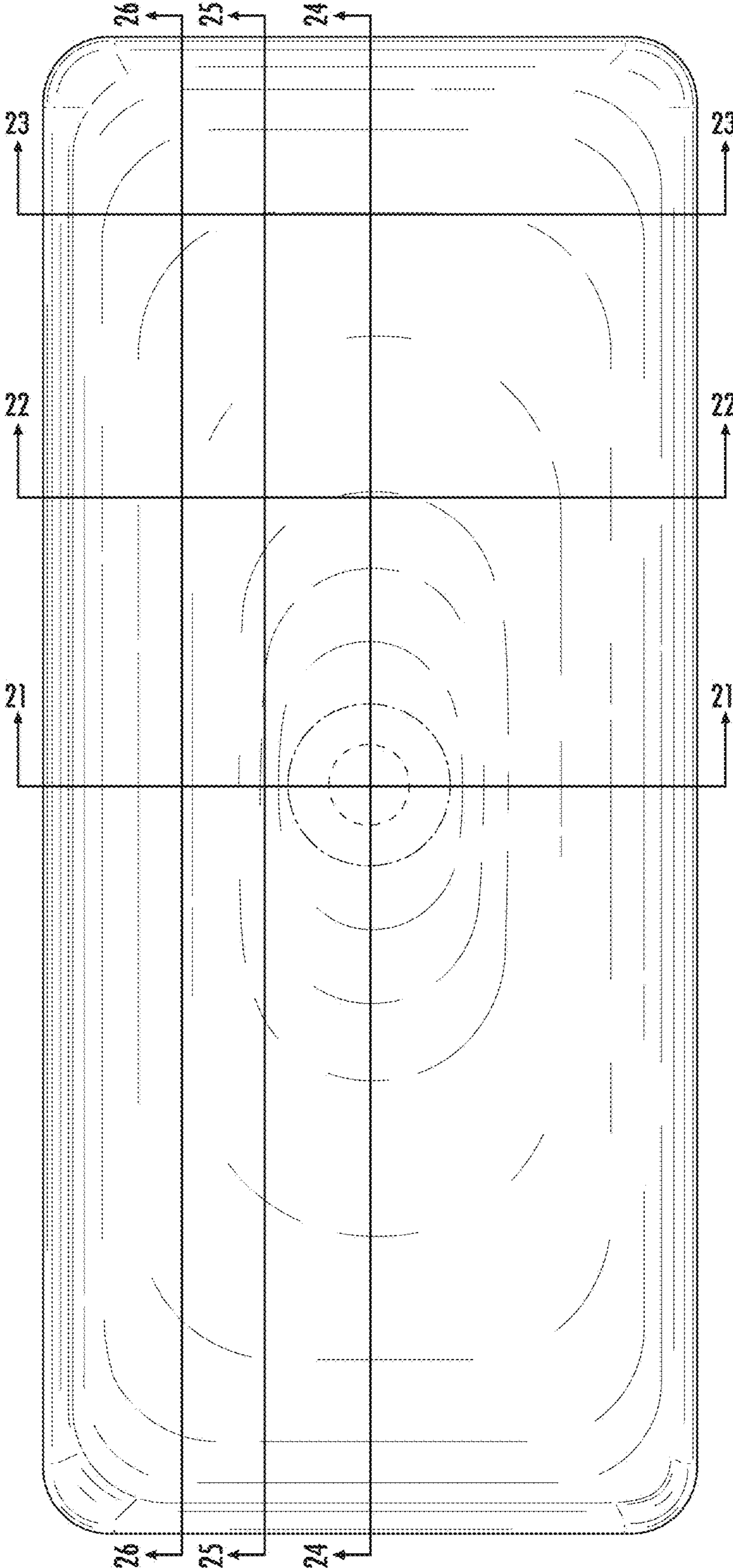

FIG. 19

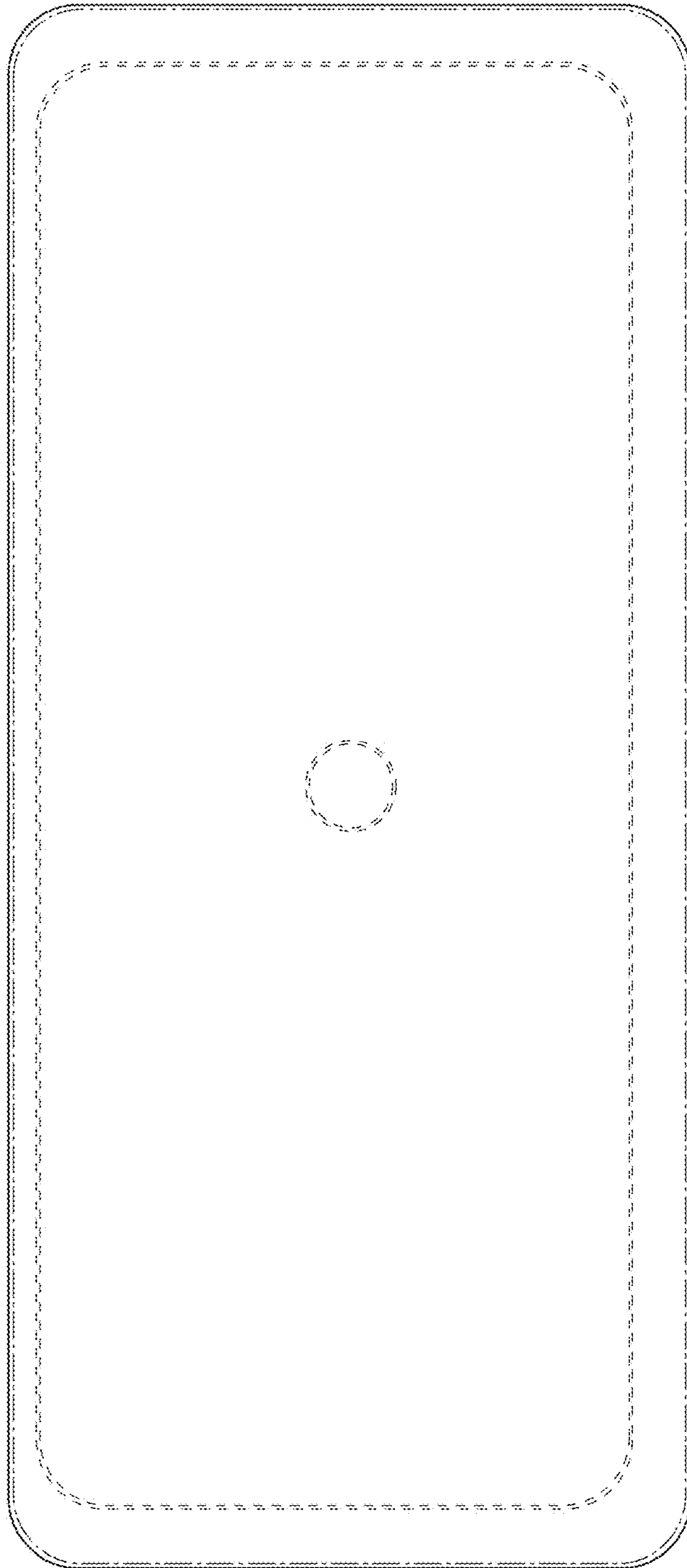
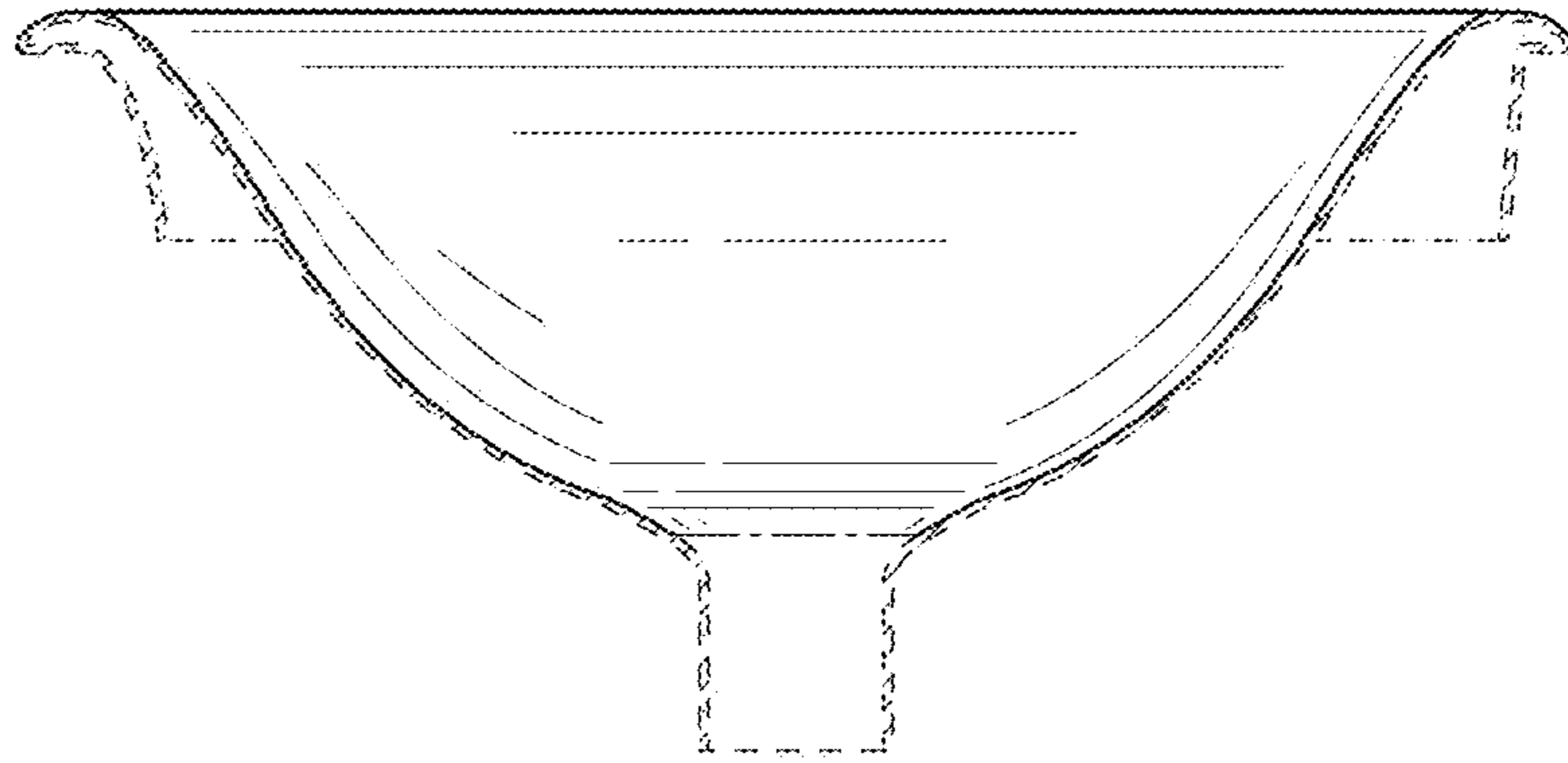
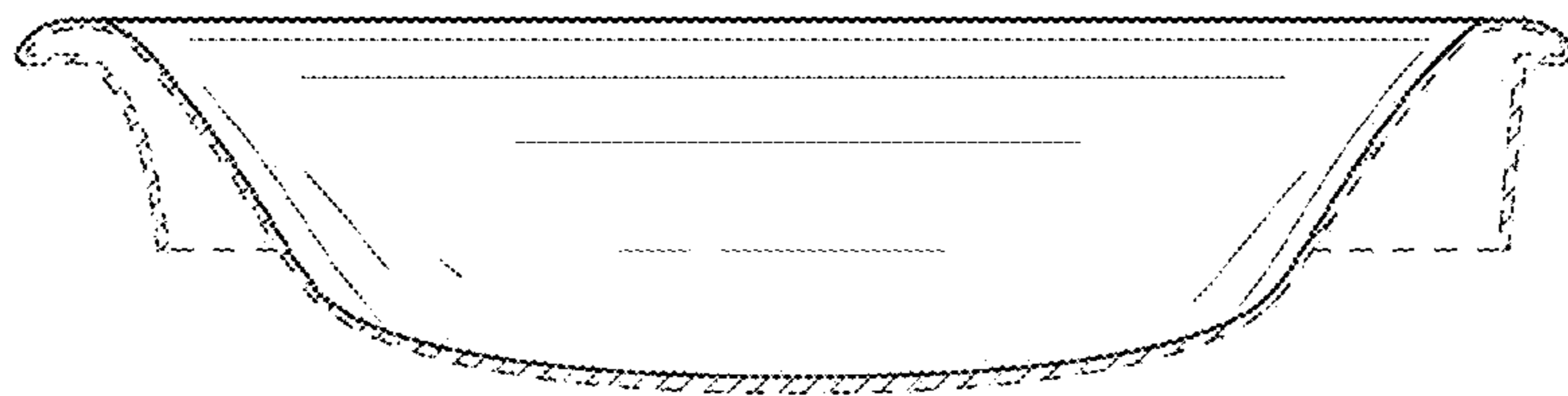

FIG. 20



**FIG. 21**



**FIG. 22**

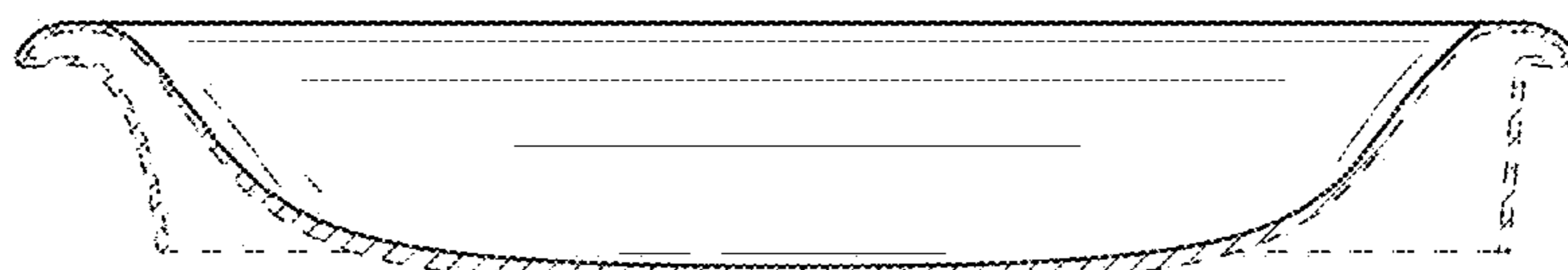

**FIG. 23**

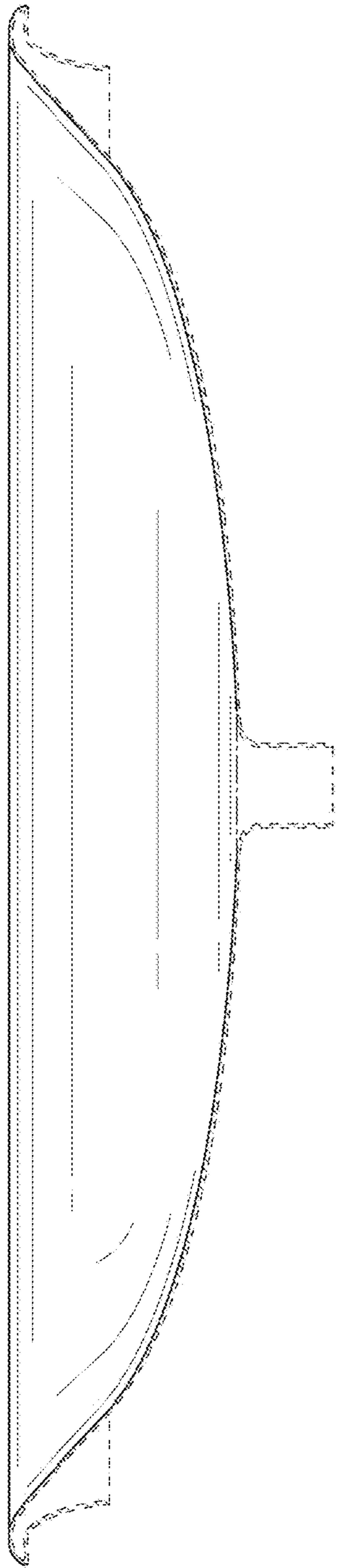

FIG. 24

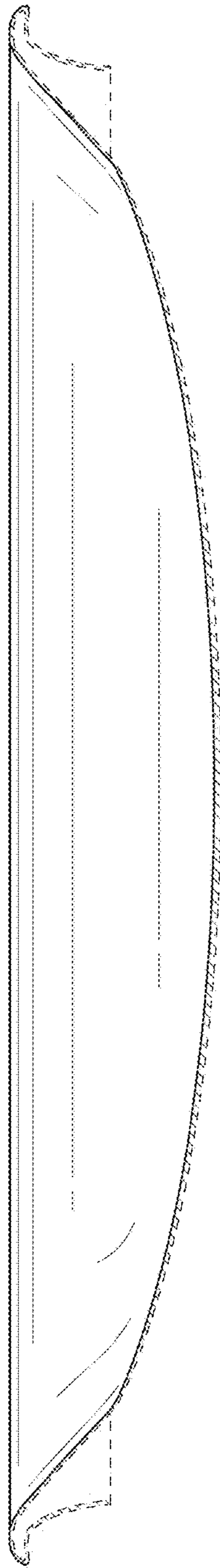

FIG. 25

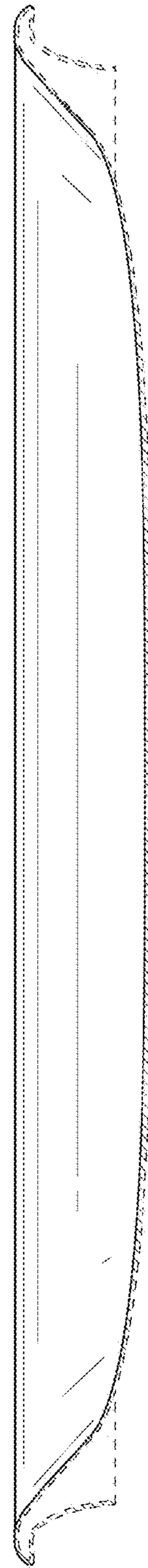

FIG. 26