



US00D824998S

(12) **United States Design Patent** (10) **Patent No.:** **US D824,998 S**
Bindra (45) **Date of Patent:** **** Aug. 7, 2018**

(54) **WRITING INSTRUMENT**
(71) Applicant: **Fibro Source U.S.A. Inc.**, San Diego, CA (US)
(72) Inventor: **Sarvjeet S. Bindra**, San Diego, CA (US)
(73) Assignee: **Fibro Source USA, Inc.**, San Diego, CA (US)

(**) Term: **15 Years**

(21) Appl. No.: **29/589,122**
(22) Filed: **Dec. 28, 2016**
(51) **LOC (11) Cl.** **19-06**
(52) **U.S. Cl.**
USPC **D19/167**; D19/918; D19/923
(58) **Field of Classification Search**
USPC D14/411; D19/115-204; D9/724, 725
CPC ... B43K 7/12; B43K 8/04; B43K 8/06; B43K 19/00; B43K 19/02; B43K 19/14; B43K 21/006; B43K 21/06; B43K 23/06; B43K 24/08

See application file for complete search history.

(56) **References Cited**

U.S. PATENT DOCUMENTS

| | | | | |
|--------------|---------|------------------|-------|---------|
| D98,255 S * | 1/1936 | Kahn | | D19/196 |
| 4,382,706 A | 5/1983 | Hashimoto et al. | | |
| D402,693 S | 12/1998 | Sunaga | | |
| D408,057 S | 4/1999 | Izushima | | |
| D410,030 S | 5/1999 | Sunaga | | |
| D410,681 S | 6/1999 | Izushima | | |
| D410,682 S | 6/1999 | Izushima | | |
| D412,014 S | 7/1999 | Izushima | | |
| D416,940 S * | 11/1999 | Ito | | D19/166 |
| D418,163 S | 12/1999 | Rosen | | |
| D418,870 S | 1/2000 | Polidoro | | |
| D418,871 S | 1/2000 | Keda | | |
| D423,577 S | 4/2000 | Baudino et al. | | |

| | | | | |
|--------------|---------|----------------|-------|---------|
| 6,203,225 B1 | 3/2001 | Baudino et al. | | |
| D441,017 S | 4/2001 | Gault et al. | | |
| D444,499 S | 7/2001 | Nakazawa | | |
| D450,769 S | 11/2001 | Nishida | | |
| D452,526 S * | 12/2001 | Nishida | | D19/166 |
| D453,790 S | 2/2002 | Tsuchikura | | |
| D455,179 S * | 4/2002 | Oka | | D19/197 |
| D456,040 S * | 4/2002 | Moon | | D19/169 |
| D457,917 S | 5/2002 | Traut et al. | | |
| D458,306 S | 6/2002 | Moon | | |
| D465,238 S | 11/2002 | Qiu | | |
| D471,588 S * | 3/2003 | Hu | | D19/166 |

(Continued)

OTHER PUBLICATIONS

Uni-ball—Power Tank RT; <http://www.uniball-na.com/main.taf?p=2,1,1>; 4 pages; Nov. 27, 2006.

Primary Examiner — Elizabeth Albert

(74) *Attorney, Agent, or Firm* — Frank J. Bonini, Jr.; John F. A. Earley, III; Harding, Earley, Follmer & Frailey, PC

(57) **CLAIM**

The ornamental design for a writing instrument, as shown and described.

DESCRIPTION

FIG. 1 is a front, left perspective view of a writing instrument showing my new design;
FIG. 2 is a front elevational view thereof;
FIG. 3 is a rear elevational view thereof;
FIG. 4 is a right side elevational view thereof;
FIG. 5 is a left side elevational view thereof;
FIG. 6 is a top plan view thereof;
FIG. 7 is a bottom plan view thereof; and,
FIG. 8 is a left side perspective view of the writing instrument of FIG. 1, with the cap removed.
The broken lines in FIGS. 1-6 and 8 are for illustrative purposes and form no part of the claimed invention.

1 Claim, 7 Drawing Sheets

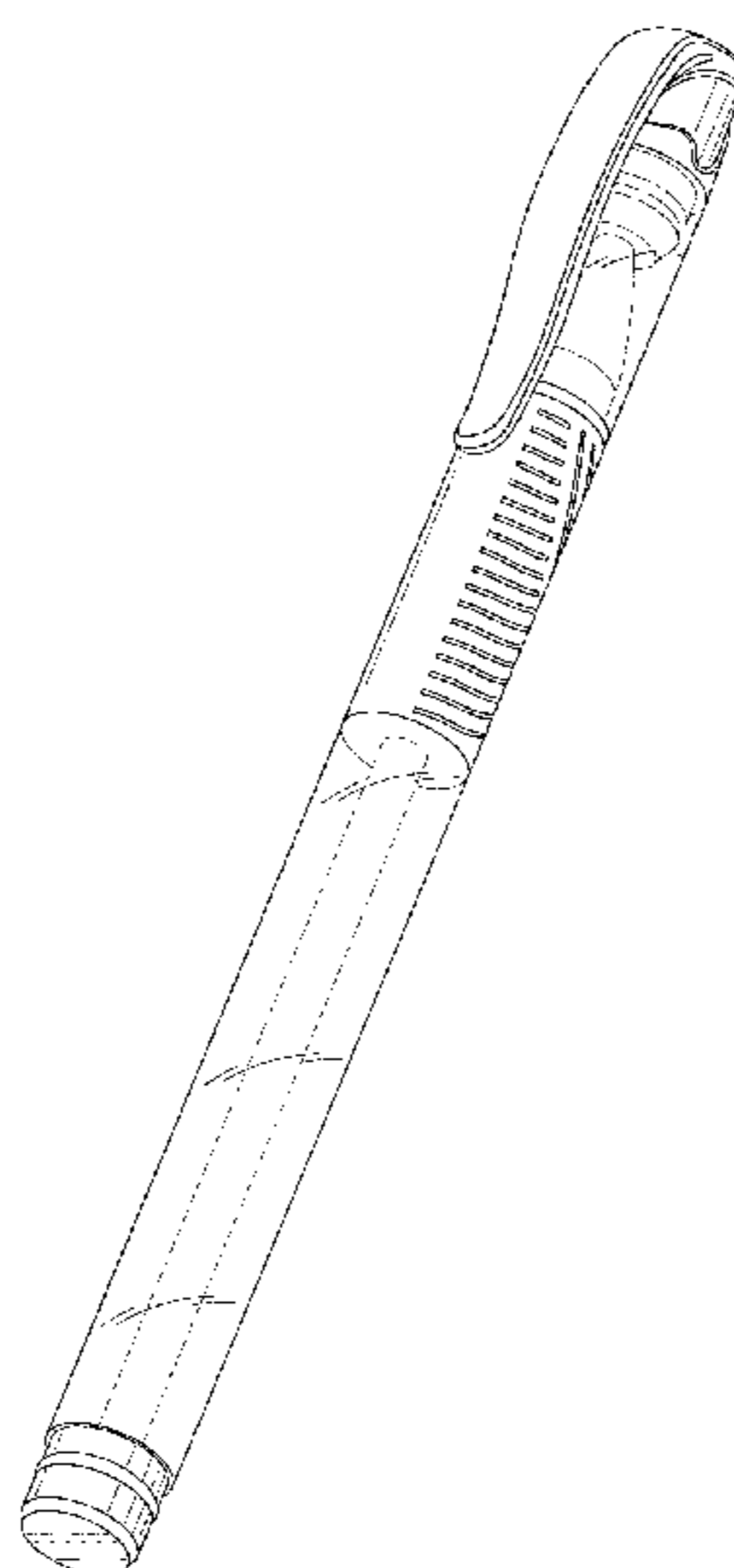

(56)

References Cited

U.S. PATENT DOCUMENTS

D476,364 S 6/2003 Bain
 D482,071 S 11/2003 Kennedy et al.
 D484,187 S 12/2003 Moon
 D489,404 S * 5/2004 Nakazawa D19/166
 D492,349 S 6/2004 Qiu
 D492,350 S 6/2004 Morrow
 D495,002 S 8/2004 Sung
 D496,399 S * 9/2004 Hoffmann D19/168
 D496,688 S 9/2004 Nishida
 D497,643 S 10/2004 Nishida
 D498,791 S 11/2004 Morrow
 D499,142 S 11/2004 Morrow
 D500,520 S 1/2005 Bain et al.
 D500,792 S 1/2005 Bain et al.
 D500,794 S 1/2005 Conklin et al.
 D506,504 S 6/2005 Nakazawa et al.
 D507,301 S 7/2005 Qiu
 D508,717 S 8/2005 Anand
 D508,950 S 8/2005 Kiple et al.
 D534,213 S 12/2006 Hageman et al.
 D542,843 S 5/2007 Qiu

D544,915 S 6/2007 Santa Maria et al.
 D548,791 S 8/2007 Santa Maria et al.
 D550,282 S 9/2007 Neuenschwanter et al.
 D553,191 S * 10/2007 Qiu D19/168
 D559,315 S 1/2008 Qiu et al.
 D562,392 S * 2/2008 Qiu D19/172
 D562,895 S * 2/2008 Shibata D19/172
 D567,855 S * 4/2008 Rolion D19/175
 D573,184 S 7/2008 Vadenne
 D600,282 S 9/2009 Guoguang
 D601,196 S * 9/2009 Zhang D19/166
 D603,454 S * 11/2009 Matsumura D19/195
 D631,913 S * 2/2011 Li D19/174
 D641,786 S * 7/2011 Rolion D19/167
 D648,791 S * 11/2011 Li D19/173
 D695,830 S * 12/2013 Casciotti D19/199
 D699,292 S * 2/2014 Wang D19/167
 D701,913 S * 4/2014 Li D19/173
 D713,878 S 9/2014 Fleming
 D776,760 S * 1/2017 Simon D19/167
 D782,576 S * 3/2017 Laemle D19/172
 2009/0129065 A1 * 5/2009 Tamir B43K 7/005
 362/118

* cited by examiner

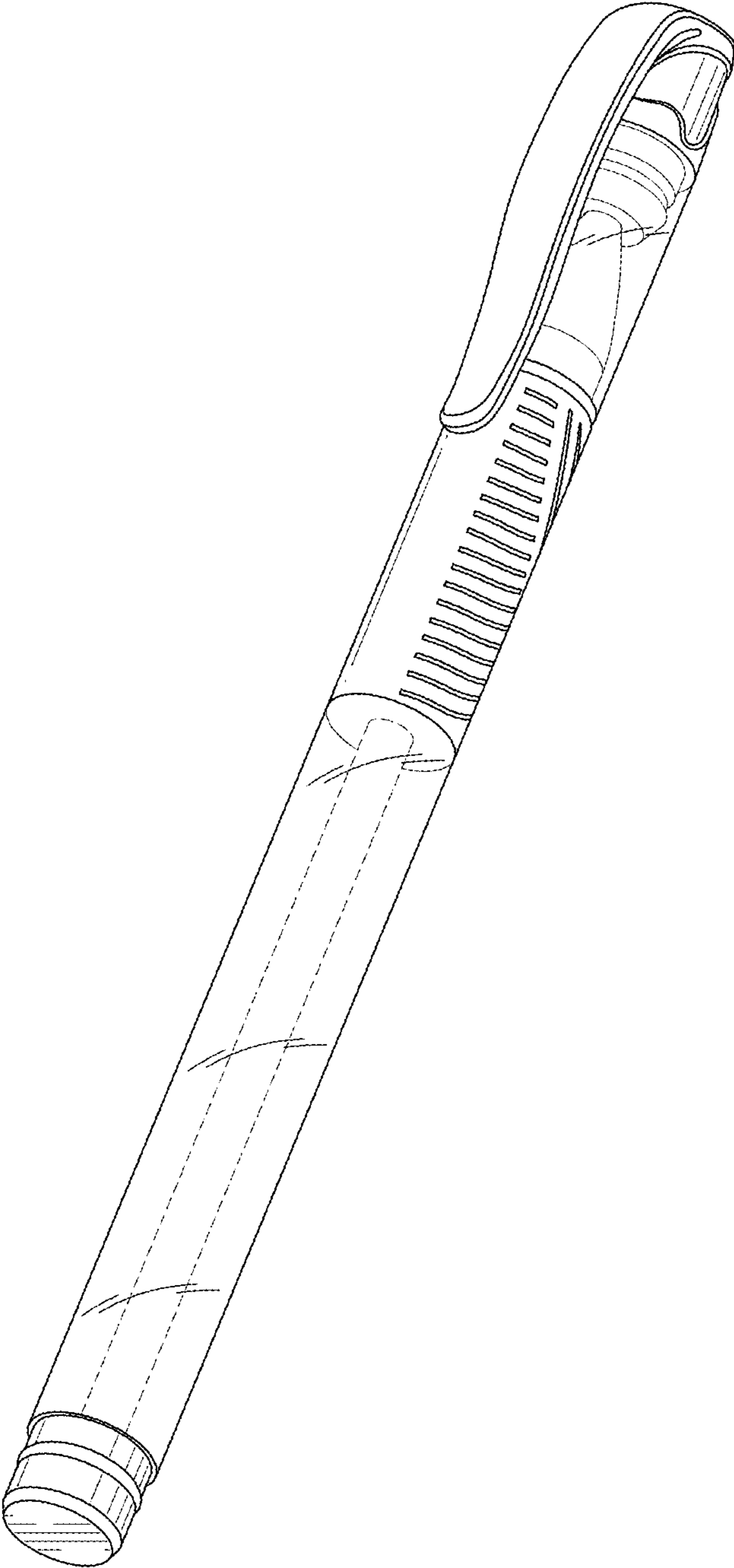

FIG. 1

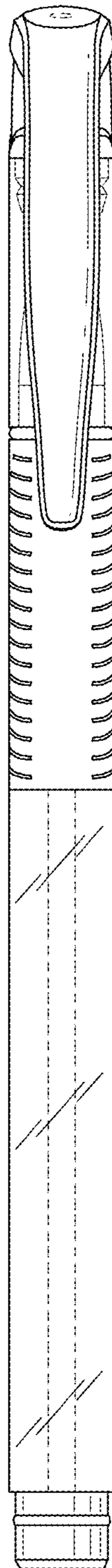

FIG. 2

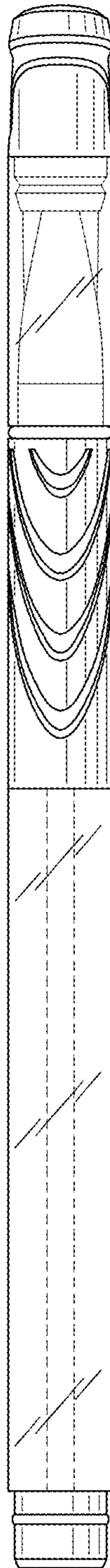

FIG. 3

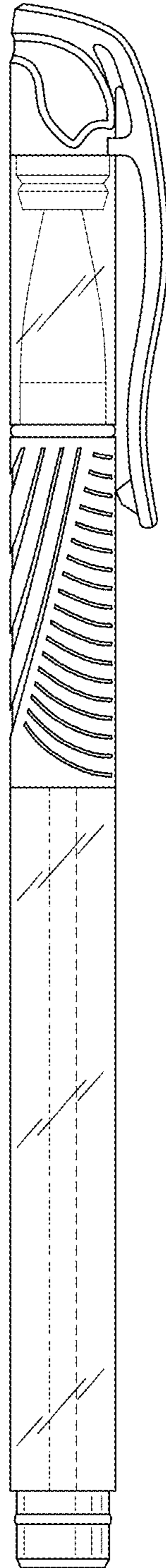

FIG.4

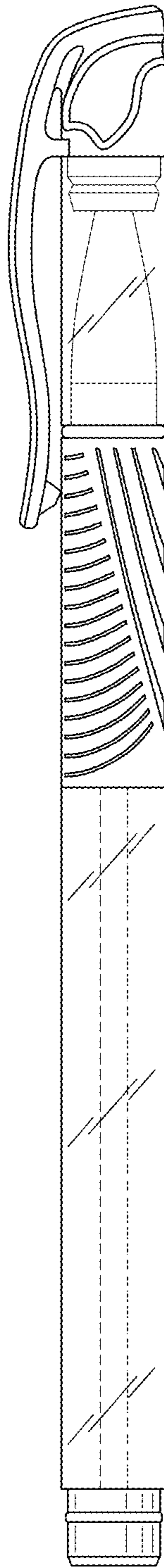

FIG. 5

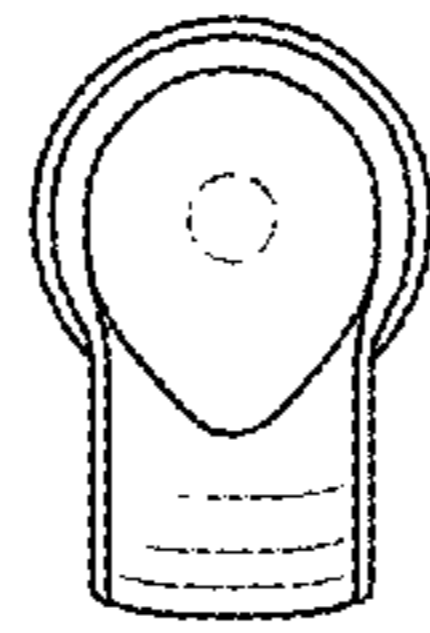

FIG. 6

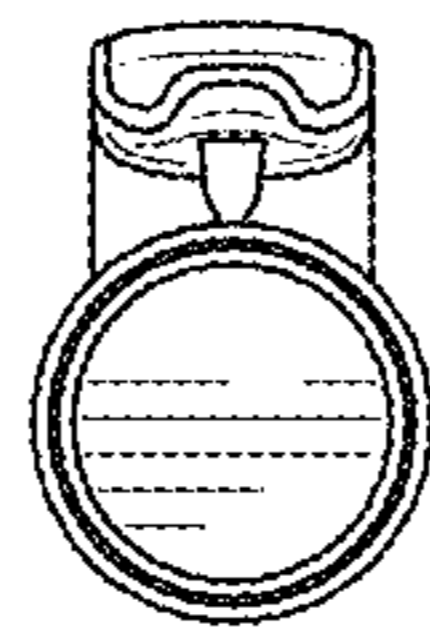

FIG. 7

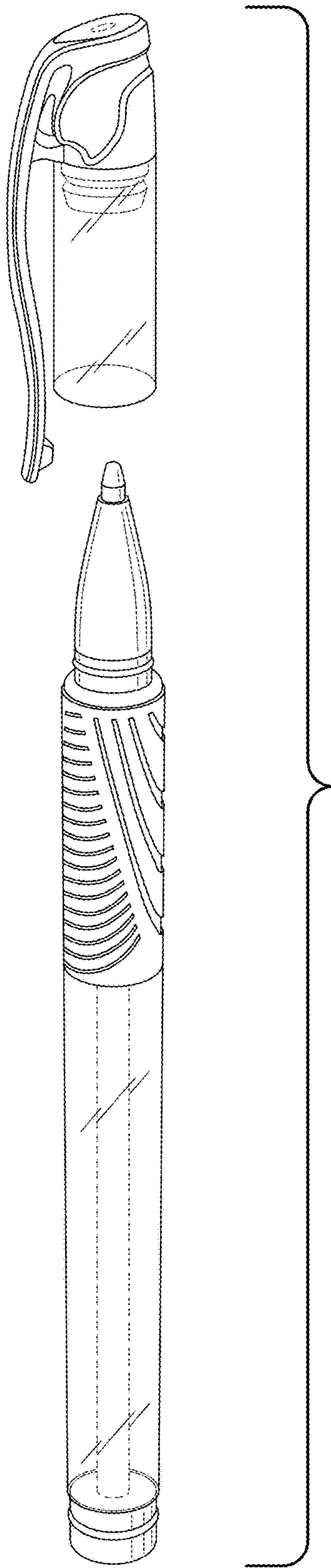

FIG. 8