



US00D824986S

(12) **United States Design Patent** (10) **Patent No.:** **US D824,986 S**
Bartram et al. (45) **Date of Patent:** **** Aug. 7, 2018**

(54) **WEB CAMERA** D407,096 S * 3/1999 Christensen D16/202
6,411,332 B1 * 6/2002 Whitby H04N 5/2251
348/373
(71) Applicant: **ASCENT INFORMATION** D511,352 S * 11/2005 Oliver D16/203
TECHNOLOGY LIMITED, London
(GB) D537,856 S * 3/2007 Tsao 248/160
D548,763 S * 8/2007 Boris D16/202
(72) Inventors: **Daniel Bartram**, Swadlincote (GB); D569,887 S * 5/2008 Feng D16/202
Andrew Fan, Coventry (GB) 8,072,536 B1 * 12/2011 Campbell F16M 11/10
348/143
(73) Assignee: **Ascent Information Technology** D729,296 S * 5/2015 Shelton D16/202
Limited, London (GB) D755,876 S * 5/2016 Moss D16/214
D755,880 S * 5/2016 Luo D16/214
2013/0215322 A1 * 8/2013 Haler H04N 5/232
348/373

(**) Term: **15 Years**

* cited by examiner

(21) Appl. No.: **29/548,408**

Primary Examiner — Philip S Hyder

(22) Filed: **Dec. 14, 2015**

Assistant Examiner — Ramzi Almatrahi

(51) **LOC (11) Cl.** **16-01**

(74) *Attorney, Agent, or Firm* — McGarry Bair PC

(52) **U.S. Cl.**
USPC **D16/214; D16/202**

(57) **CLAIM**

(58) **Field of Classification Search**
USPC D16/200, 202–206, 214–215, 218, 219,
D16/242, 244; 348/14.01–14.06, 143,
348/148, 373–376; 396/419, 427, 535,
396/539–541

The ornamental design for a web camera, as shown and described.

CPC G03B 15/00; G03B 15/03; G03B 15/06;
G03B 17/02; G03B 17/04; G03B 17/53;
G03B 17/56; G03B 19/04; H04N 5/2251;
H04N 5/2252; H04N 5/2253; H04N
5/2254; H04N 2101/00

DESCRIPTION

See application file for complete search history.

FIG. 1 is a front and left side perspective view of a web camera;
FIG. 2 is a front elevation view thereof;
FIG. 3 is a right side elevation view thereof;
FIG. 4 is a rear elevation view thereof;
FIG. 5 is a left side elevation view thereof; and,
FIG. 6 is a top plan view thereof.

(56) **References Cited**

The broken lines depict portions of the web camera in which the design is embodied and form no part of the claimed design.

U.S. PATENT DOCUMENTS

D377,032 S * 12/1996 Morooka D16/202
D403,338 S * 12/1998 Dunn D16/131

1 Claim, 4 Drawing Sheets

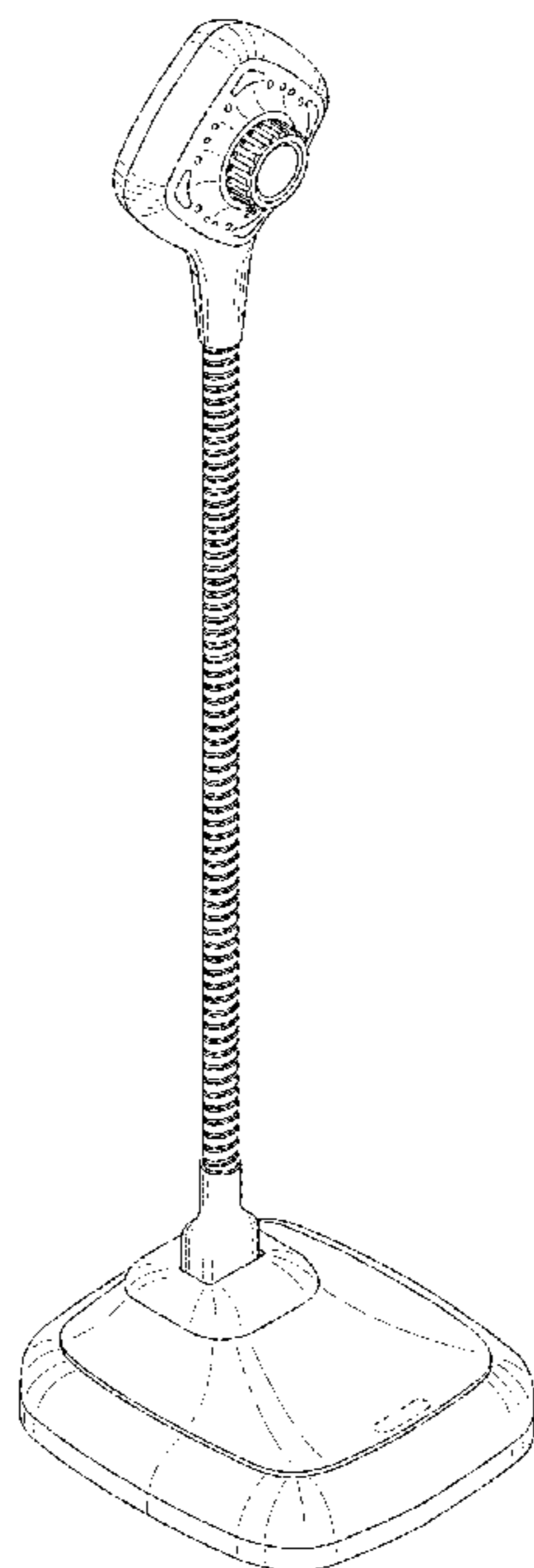

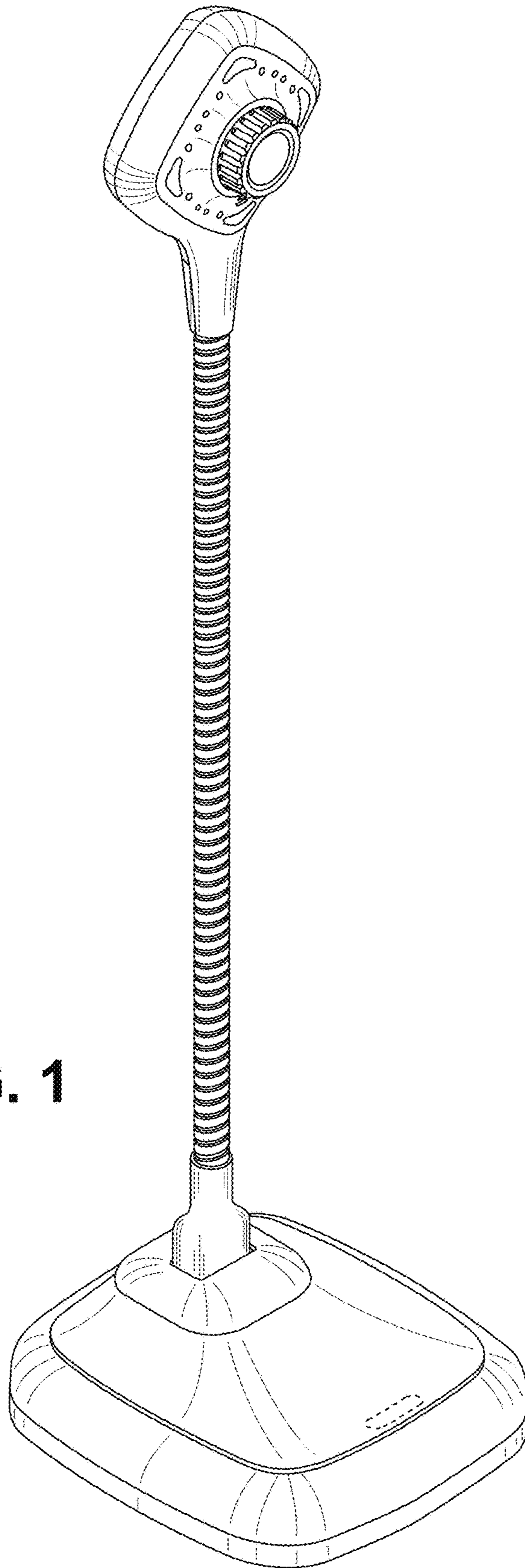

FIG. 1

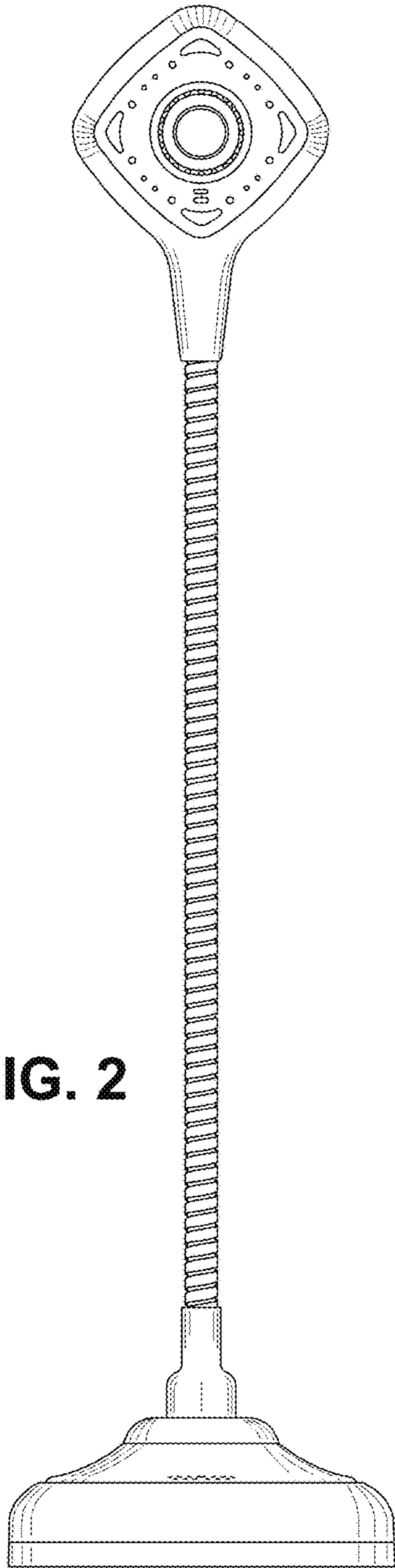

FIG. 2

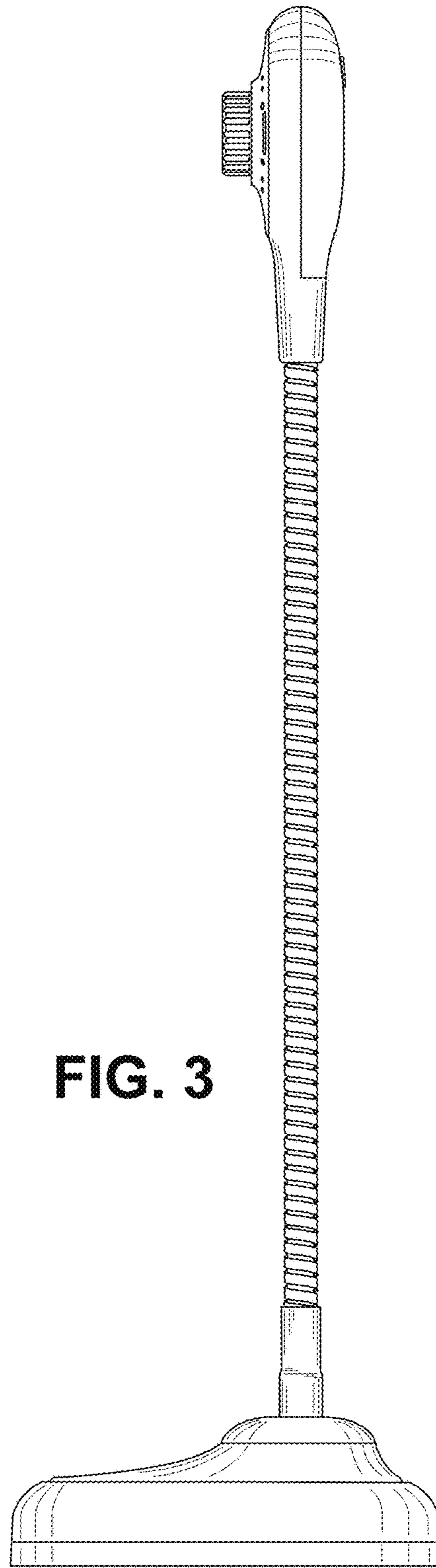

FIG. 3

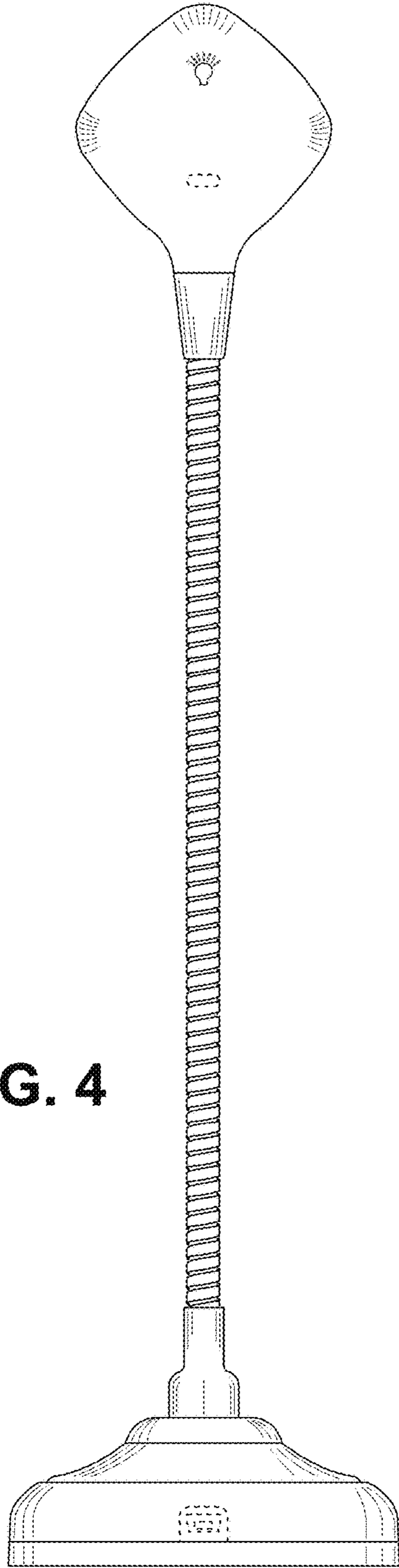

FIG. 4

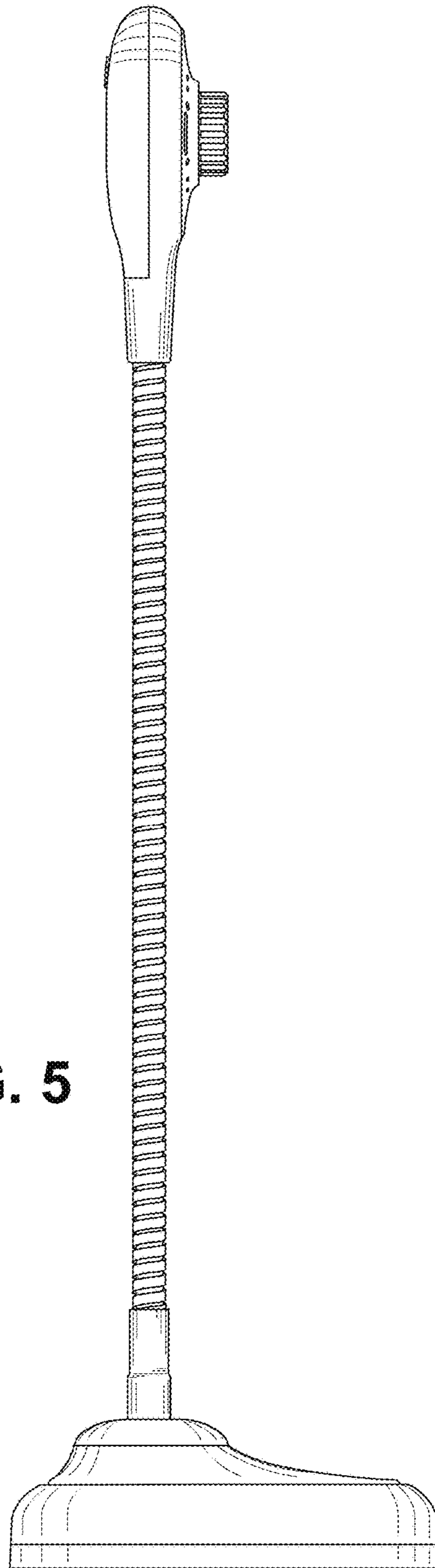

FIG. 5

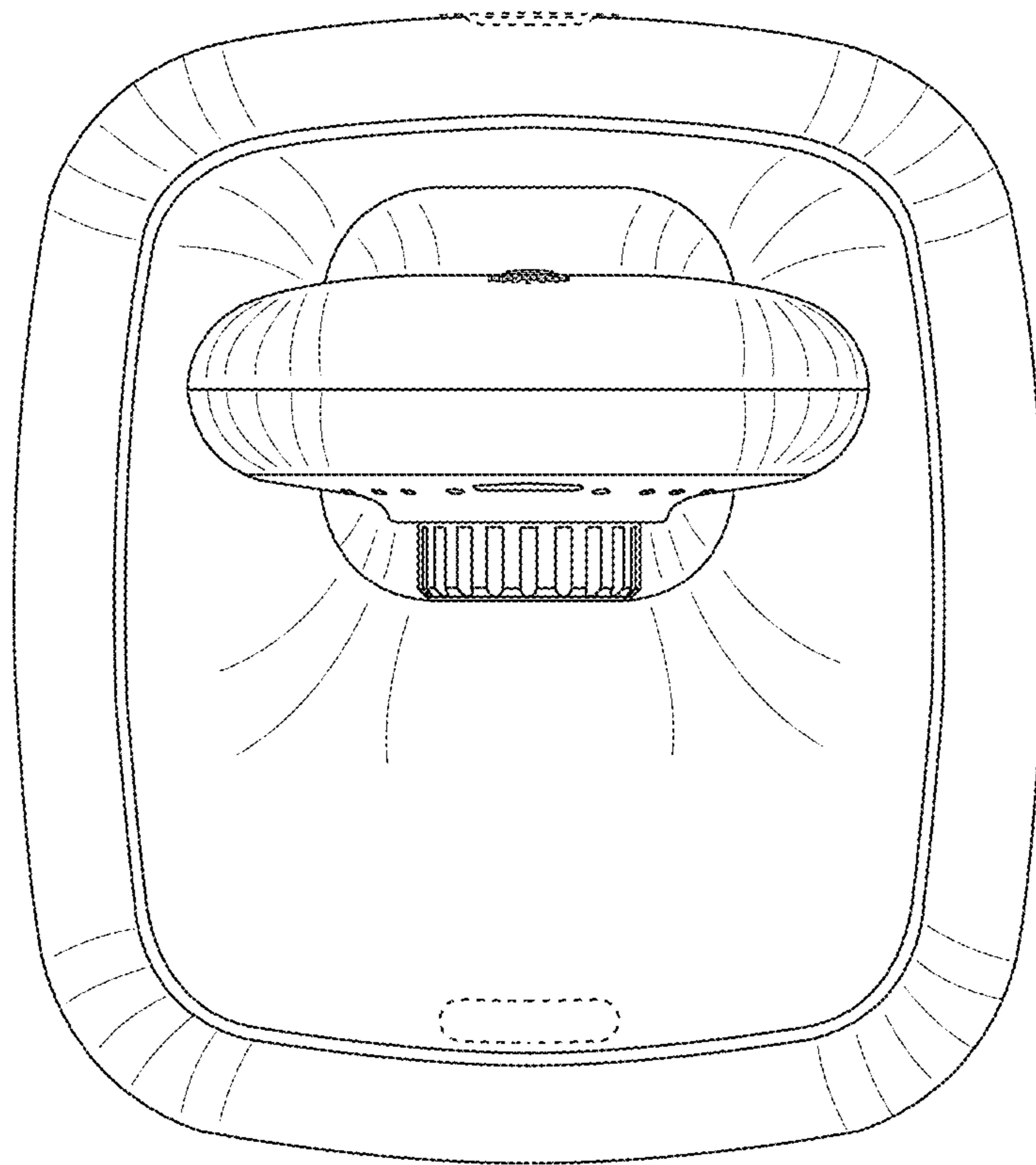

FIG. 6

UNITED STATES PATENT AND TRADEMARK OFFICE
CERTIFICATE OF CORRECTION

PATENT NO. : D824,986 S
APPLICATION NO. : 29/548408
DATED : August 7, 2018
INVENTOR(S) : Daniel Bartram et al.

Page 1 of 1

It is certified that error appears in the above-identified patent and that said Letters Patent is hereby corrected as shown below:

On the Title Page

Add the following:

Item (30) Foreign Application Priority Data

Oct. 14, 2015 (EUIPO) 002822908

Signed and Sealed this
Twentieth Day of November, 2018

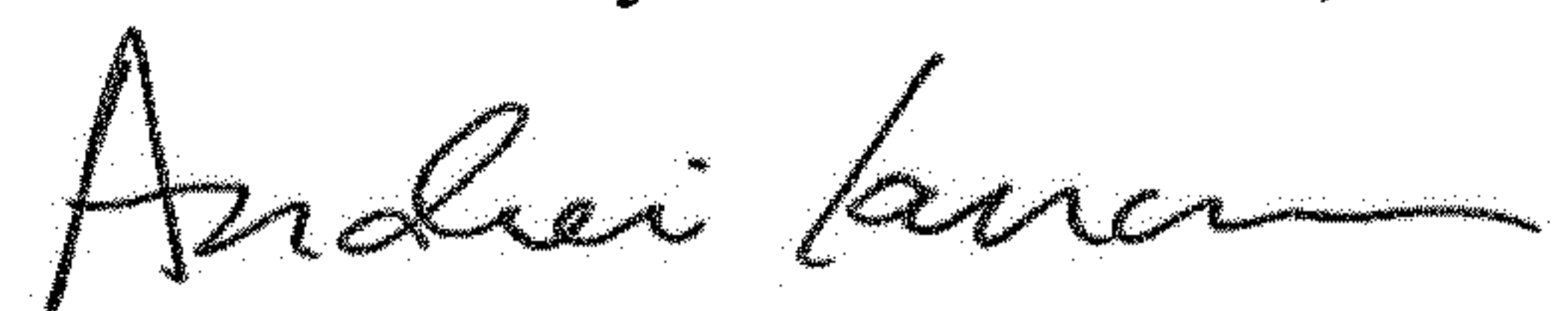

Andrei Iancu
Director of the United States Patent and Trademark Office