



US00D824781S

(12) **United States Design Patent**
Lee

(10) **Patent No.:** **US D824,781 S**
(45) **Date of Patent:** **** Aug. 7, 2018**

(54) **TRANSPARENT ZIPPER BAG**

(71) Applicant: **Kikkerland Design, Inc.**, New York, NY (US)

(72) Inventor: **Jaeyu Lee**, New York, NY (US)

(73) Assignee: **Kikkerland Design, Inc.**, New York, NY (US)

(**) Term: **15 Years**

(21) Appl. No.: **29/564,114**

(22) Filed: **May 10, 2016**

(51) **LOC (11) Cl.** **09-05**

(52) **U.S. Cl.**
USPC **D9/709**

(58) **Field of Classification Search**
USPC D9/702-714, 558, 520, 779, 502-505;
215/379; D7/509-511, 601-602, 502,
D7/507-508; 62/457.1-457.4
CPC B65D 1/00; B65D 1/02; B65D 1/0223;
B65D 1/10; B65D 23/00; B65D 2501/00;
B65D 2501/0009; B65D 2501/0081
See application file for complete search history.

(56) **References Cited**

U.S. PATENT DOCUMENTS

D601,431 S * 10/2009 Serrano Diaz D9/542
D622,991 S * 9/2010 MacDonald D6/542

D660,655 S * 5/2012 Wahl D7/608
D679,959 S * 4/2013 Lane D7/615
D682,626 S * 5/2013 Lane D7/629
D708,471 S * 7/2014 Colquhoun D7/391
D787,340 S * 5/2017 Pape D9/703

* cited by examiner

Primary Examiner — Abraham Bahta

(74) *Attorney, Agent, or Firm* — Charles H. Jew

(57) **CLAIM**

The ornamental design for a transparent zipper bag, as shown and described.

DESCRIPTION

FIG. 1 is a front view of a transparent zipper bag showing my design;

FIG. 2 is a rear view thereof;

FIG. 3 is a left side view thereof;

FIG. 4 is a right side view thereof;

FIG. 5 is a top view thereof;

FIG. 6 is a bottom view thereof;

FIG. 7 is a front perspective view thereof;

FIG. 8 is a left side view thereof with the transparent zipper bag in an unsealed and opened positioned; and,

FIG. 9 is a left side view thereof with the transparent zipper bag in a sealed positioned and with an item stored inside the transparent zipper bag.

The broken lines in FIG. 9 showing the item in the transparent zipper bag are for illustrative purposes only and do not form part of claimed design.

1 Claim, 2 Drawing Sheets

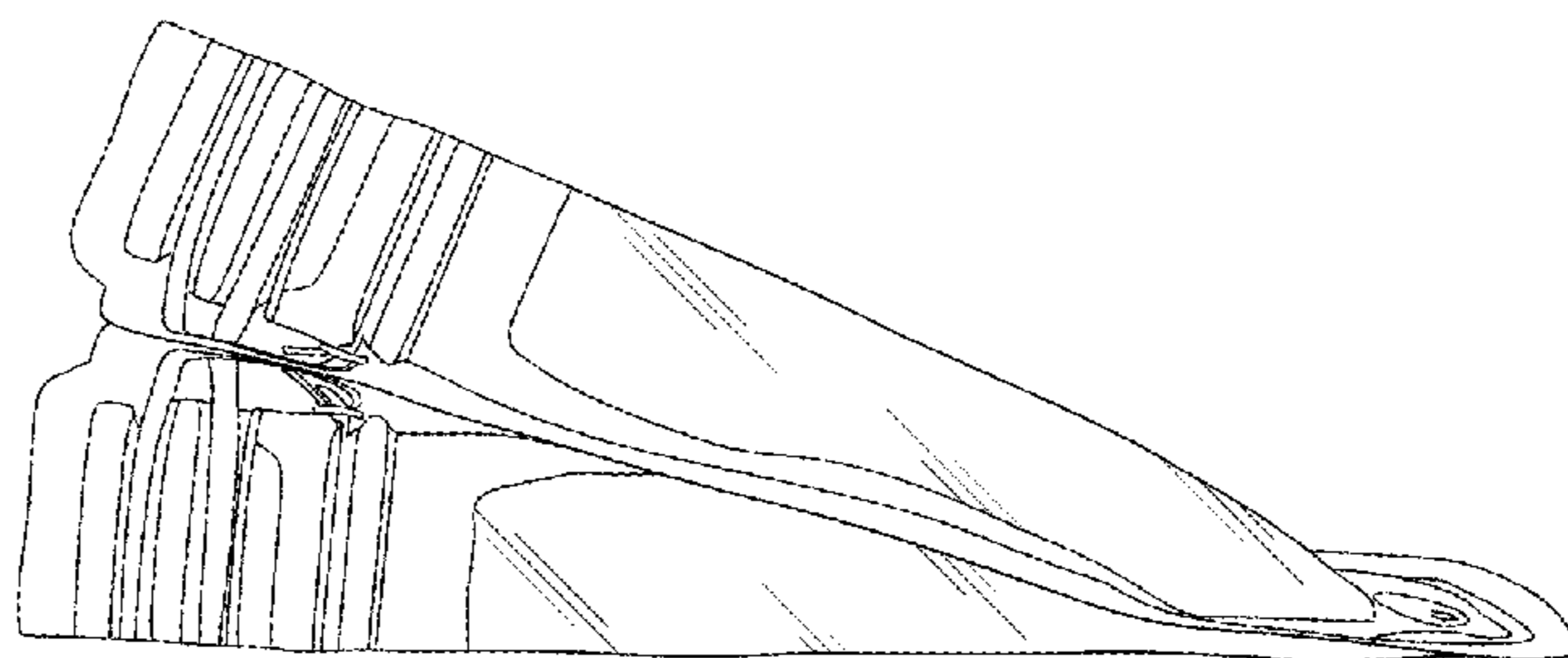
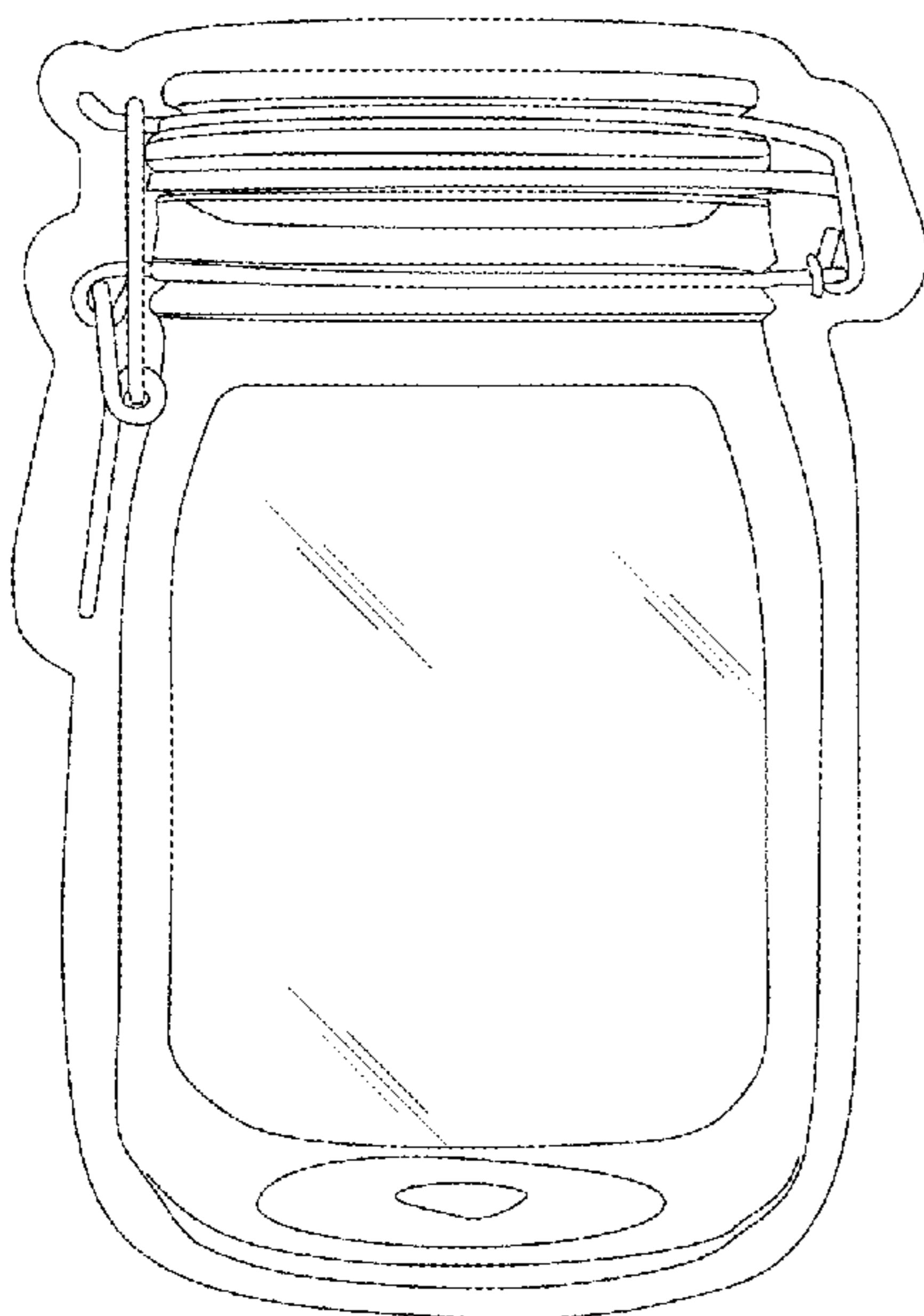

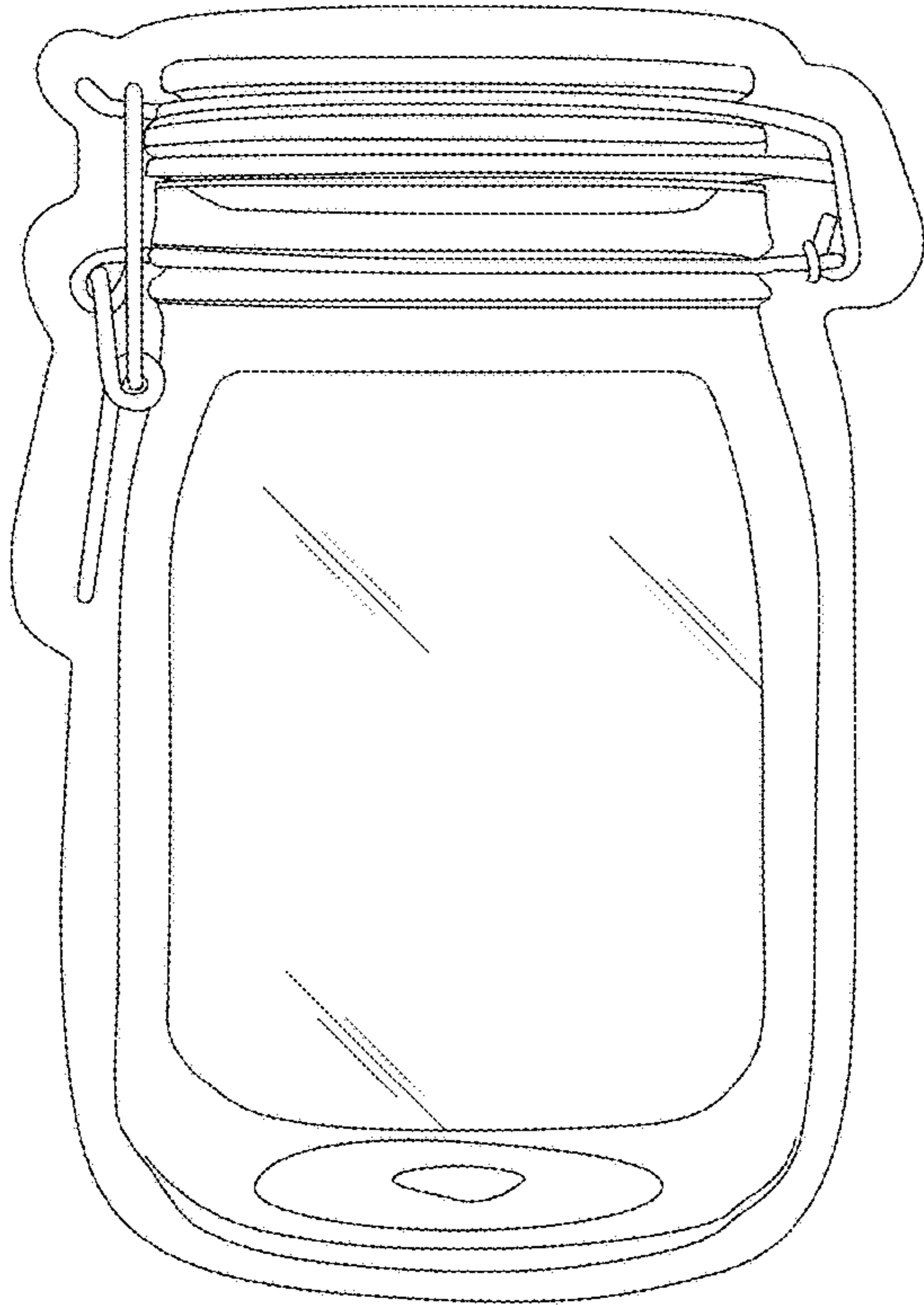

FIG. 1

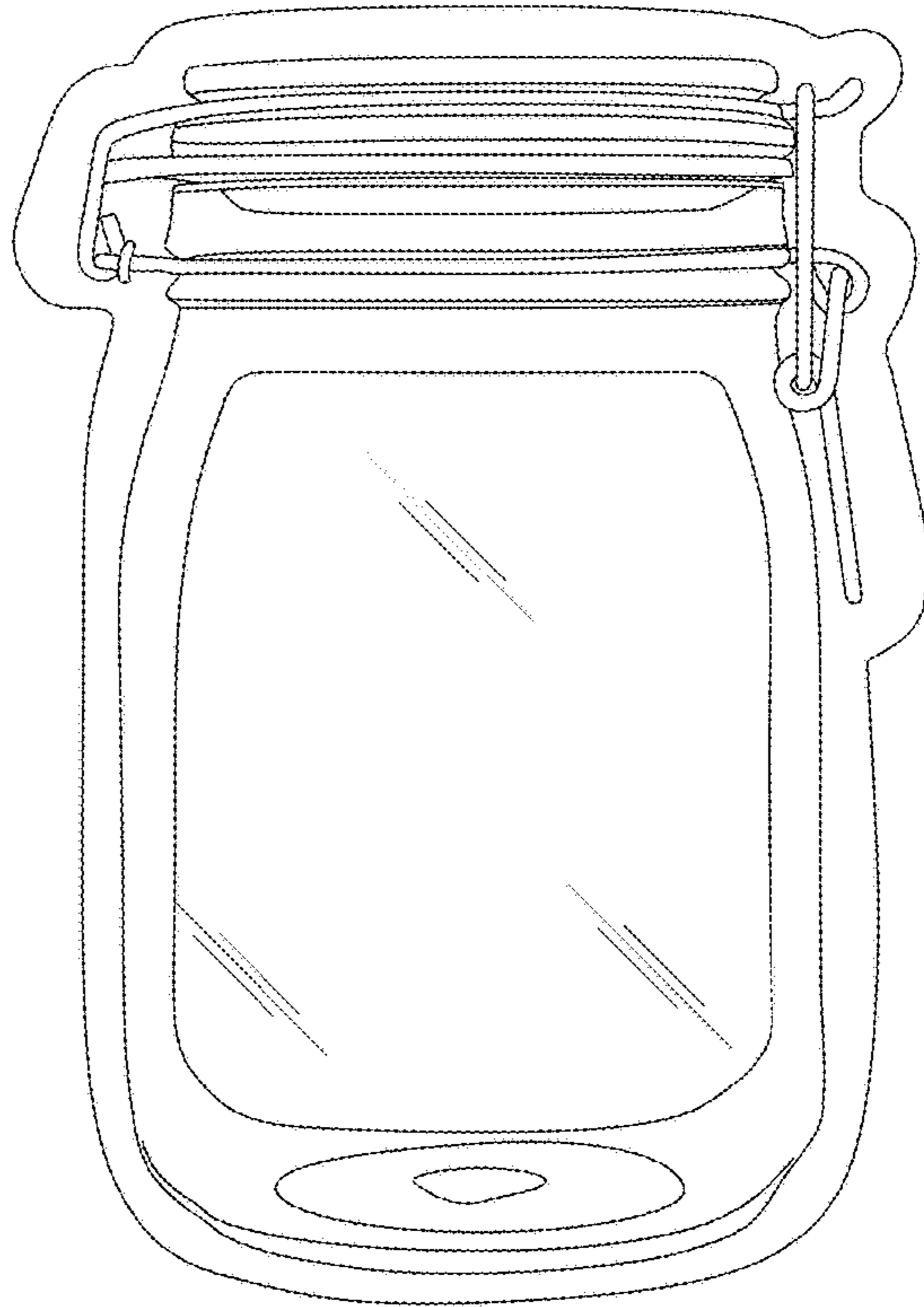

FIG. 2

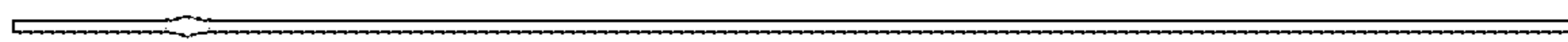

FIG. 3

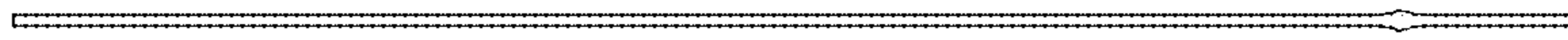

FIG. 4

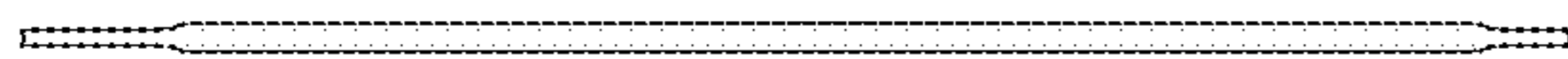

FIG. 5

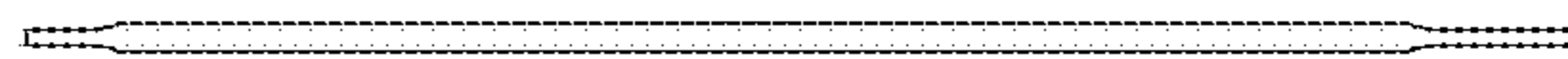

FIG. 6

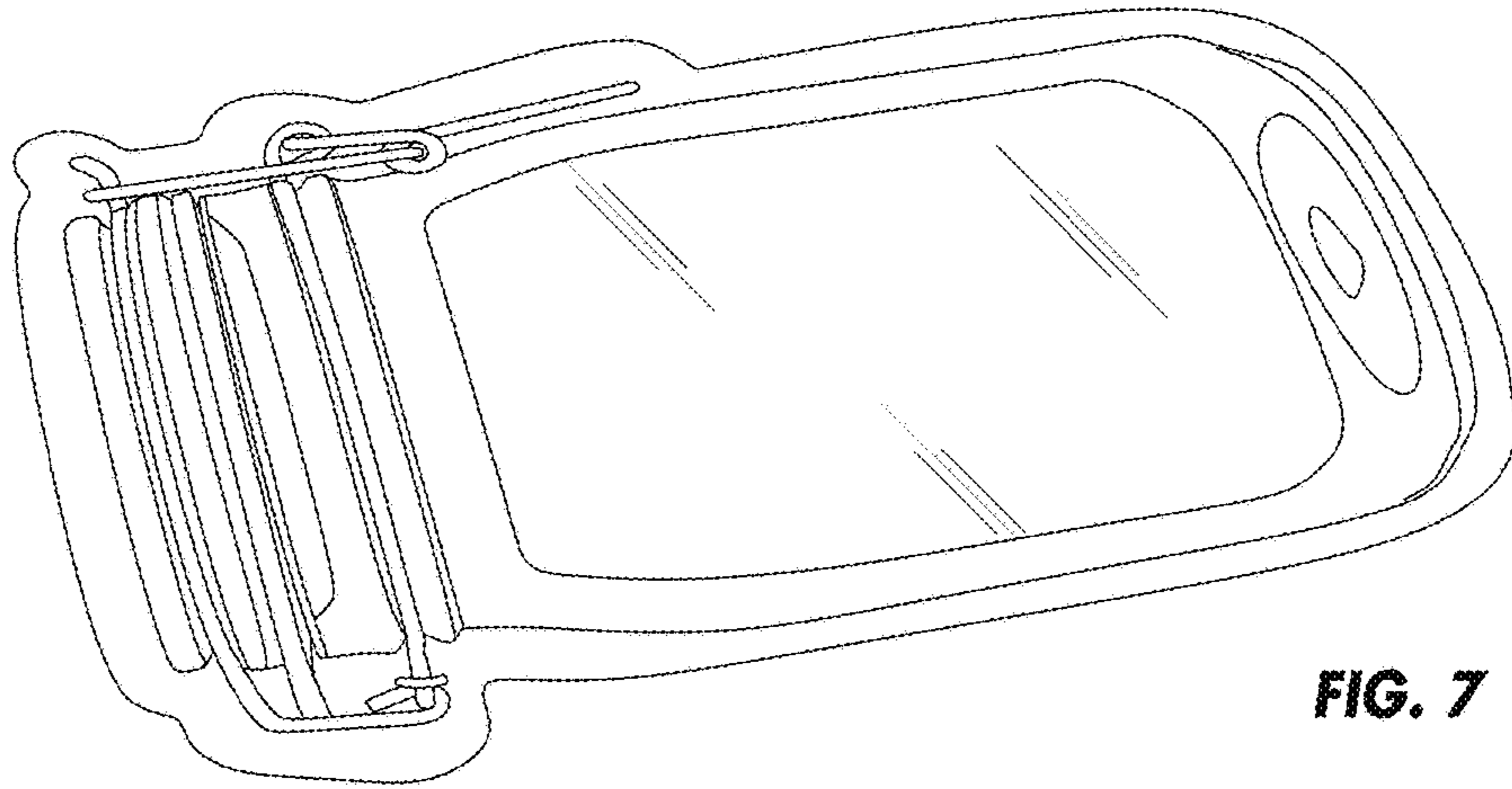

FIG. 7

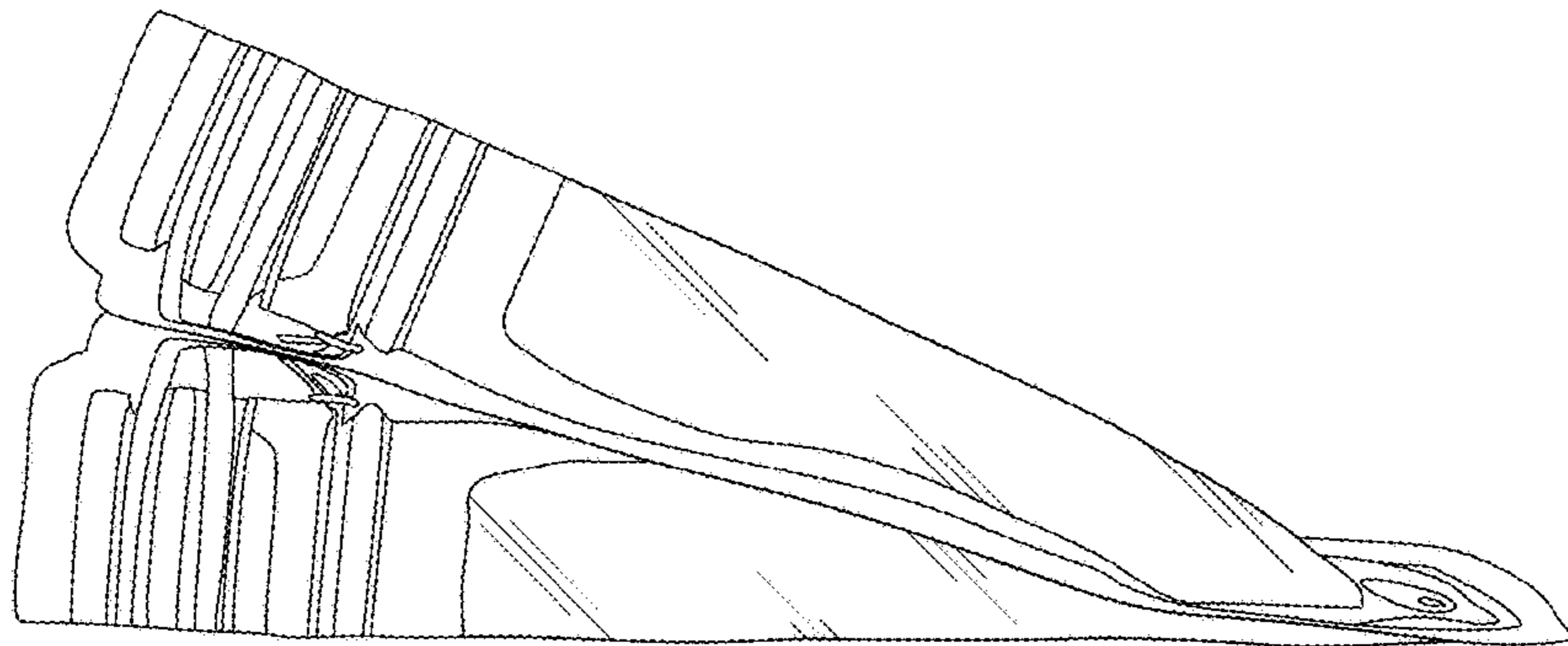

FIG. 8



FIG. 9