



US00D824704S

(12) **United States Design Patent** (10) **Patent No.:** **US D824,704 S**
Cully et al. (45) **Date of Patent:** **** *Aug. 7, 2018**

(54) **RETAIL FURNISHINGS GROUP**
(71) Applicant: **Apple Inc.**, Cupertino, CA (US)
(72) Inventors: **Rebecca M. Cully**, Moss Beach, CA (US); **Jennifer Ross Wynn**, San Francisco, CA (US); **Christopher M. Green**, Woodside, CA (US); **Christopher Daniel Peak**, Oakland, CA (US); **David Kahl Peschel**, San Carlos, CA (US); **Stefan Behling**, London (GB); **James Sherman**, London (GB); **Vasileios Bakas**, London (GB)

(73) Assignee: **Apple Inc.**, Cupertino, CA (US)
(*) Notice: This patent is subject to a terminal disclaimer.
(**) Term: **15 Years**
(21) Appl. No.: **29/571,098**
(22) Filed: **Jul. 14, 2016**

Related U.S. Application Data

(63) Continuation of application No. 29/537,119, filed on Aug. 21, 2015, now Pat. No. Des. 812,771.
(51) **LOC (11) Cl.** **06-03**
(52) **U.S. Cl.**
USPC **D6/686**
(58) **Field of Classification Search**
USPC D25/1-30, 31-34, 35, 55-59; D6/673, D6/335, 686; 52/33, 29; D21/506-511
CPC E04H 1/04; E04H 1/06; E04H 3/02; E04H 3/04; E04H 1/12; E04H 1/1205; E04H 1/1222
See application file for complete search history.

(56) **References Cited**
U.S. PATENT DOCUMENTS
1,494,390 A * 5/1924 Stevenson E04H 3/04 186/52
D151,715 S * 11/1948 Rettinger D25/12
D395,521 S * 6/1998 De Leu D25/58
D581,173 S * 11/2008 Skalka D6/337
D587,474 S * 3/2009 Kelly D6/335
D728,281 S * 5/2015 Heirakuji et al.
D733,323 S * 6/2015 Park D25/32
D734,627 S * 7/2015 Park D25/1
D753,419 S * 4/2016 Heirakuji et al.
D764,841 S * 8/2016 Park D25/1
D771,836 S * 11/2016 Siegel D25/33
(Continued)

OTHER PUBLICATIONS

Hotel & Gastronomy, Various Dates 2010-2014, Plants for Interior, <http://www.xn--innenraumbegnung-f3b.org/en/hotel-gastronomy.html>.
(Continued)

Primary Examiner — Susan Bennett Hattan
Assistant Examiner — Brett Miller
(74) *Attorney, Agent, or Firm* — Sterne, Kessler, Goldstein & Fox P.L.L.C.

(57) **CLAIM**
The ornamental design for a retail furnishings group, as shown and described.

DESCRIPTION

FIG. 1 is a front perspective view of a retail furnishings group showing our new design;
FIG. 2 is a left side view thereof;
FIG. 3 is a right side view thereof;
FIG. 4 is a front view thereof;
(Continued)

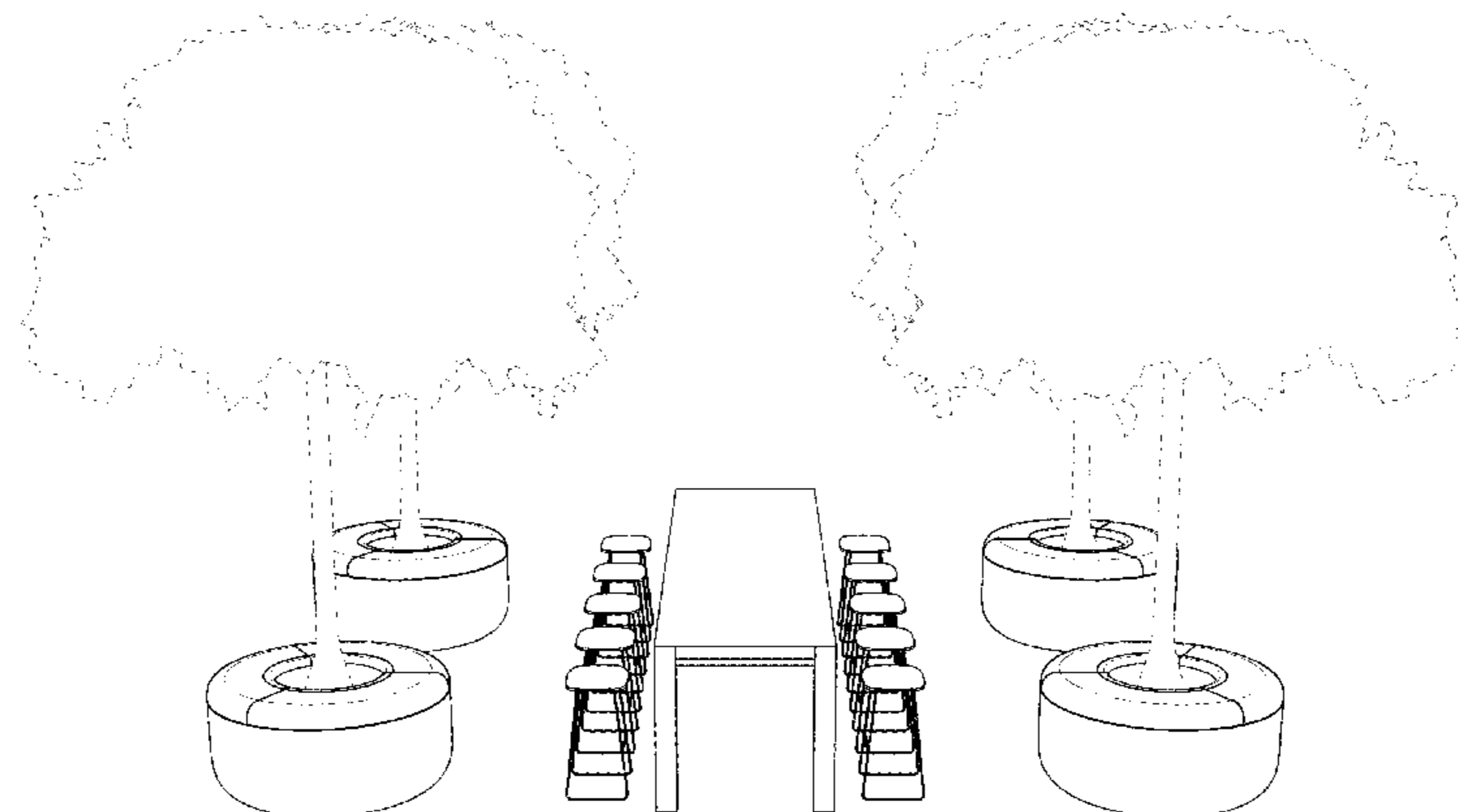

FIG. 5 is a rear view thereof; and,
FIG. 6 is a top view thereof.
The broken lines in the figures show portions of the retail
furnishings group that form no part of the claimed design.

1 Claim, 6 Drawing Sheets

(56)

References Cited

U.S. PATENT DOCUMENTS

D774,209 S * 12/2016 Siegel D25/33
2007/0000185 A1 * 1/2007 DeLine E04H 3/14
52/33

OTHER PUBLICATIONS

Interior Greening—Fashion Store, Various Dates 2013-2014, Plants
for Interior, <http://www.xn--innenraumbegrenzung-f3b.org/en/fashion-store-greening-planting.html>.*

U.S. Appl. No. 29/493,878, filed Jun. 13, 2014; Akana et al.
U.S. Appl. No. 29/493,879, filed Jun. 13, 2014; Akana et al.
U.S. Appl. No. 29/495,788, filed Jul. 3, 2014; Akana et al.
U.S. Appl. No. 29/500,951, filed Aug. 29, 2014; Akana et al.
U.S. Appl. No. 29/501,029, filed Aug. 29, 2014; Akana et al.
U.S. Appl. No. 29/501,841, filed Sep. 9, 2014; Akana et al.
U.S. Appl. No. 29/517,034, filed Feb. 9, 2015; Siegel et al.
U.S. Appl. No. 29/517,061, filed Feb. 9, 2015; Siegel et al.
U.S. Appl. No. 29/522,921, filed Apr. 3, 2015; Siegel et al.

* cited by examiner

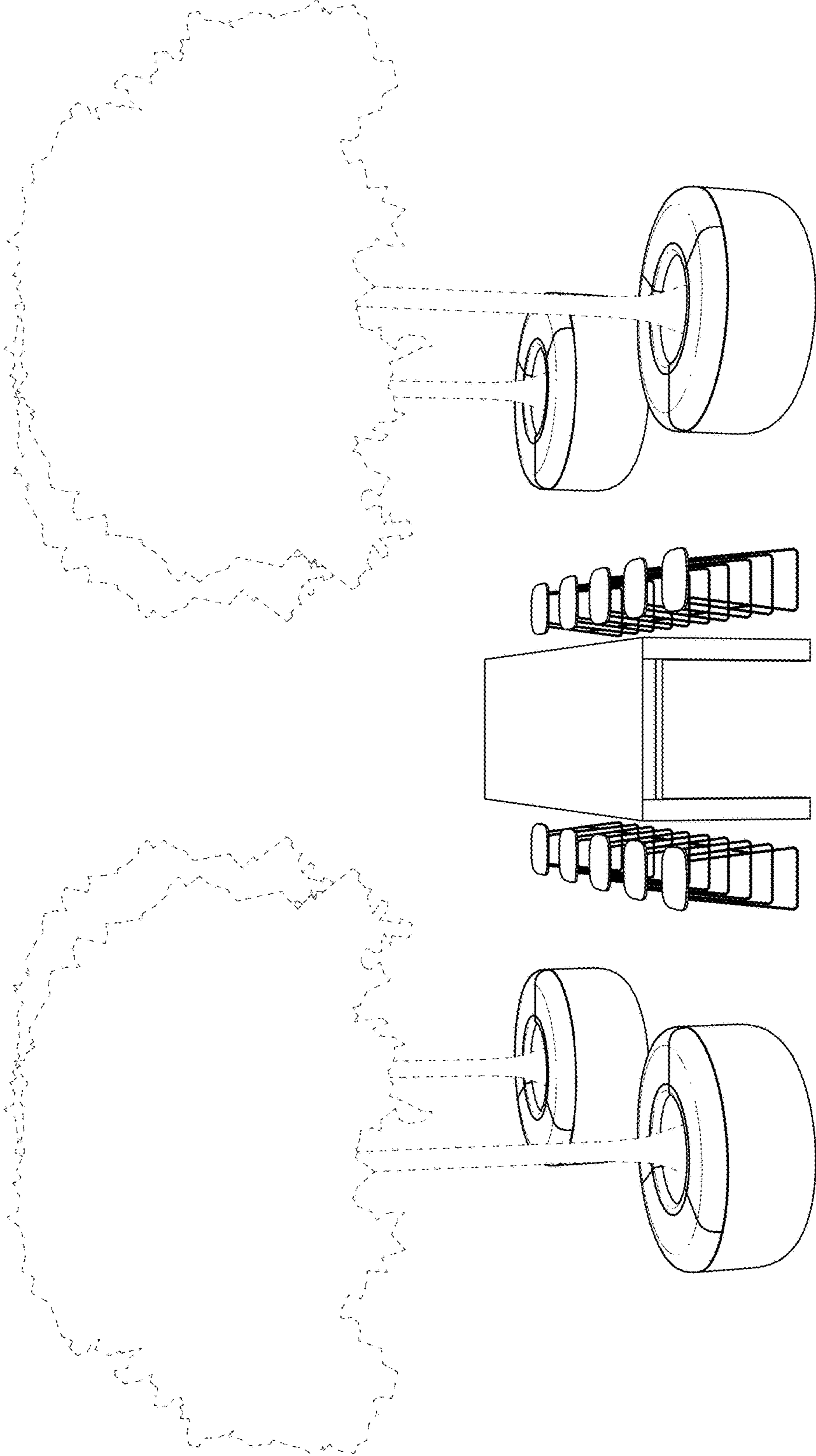

FIG. 1

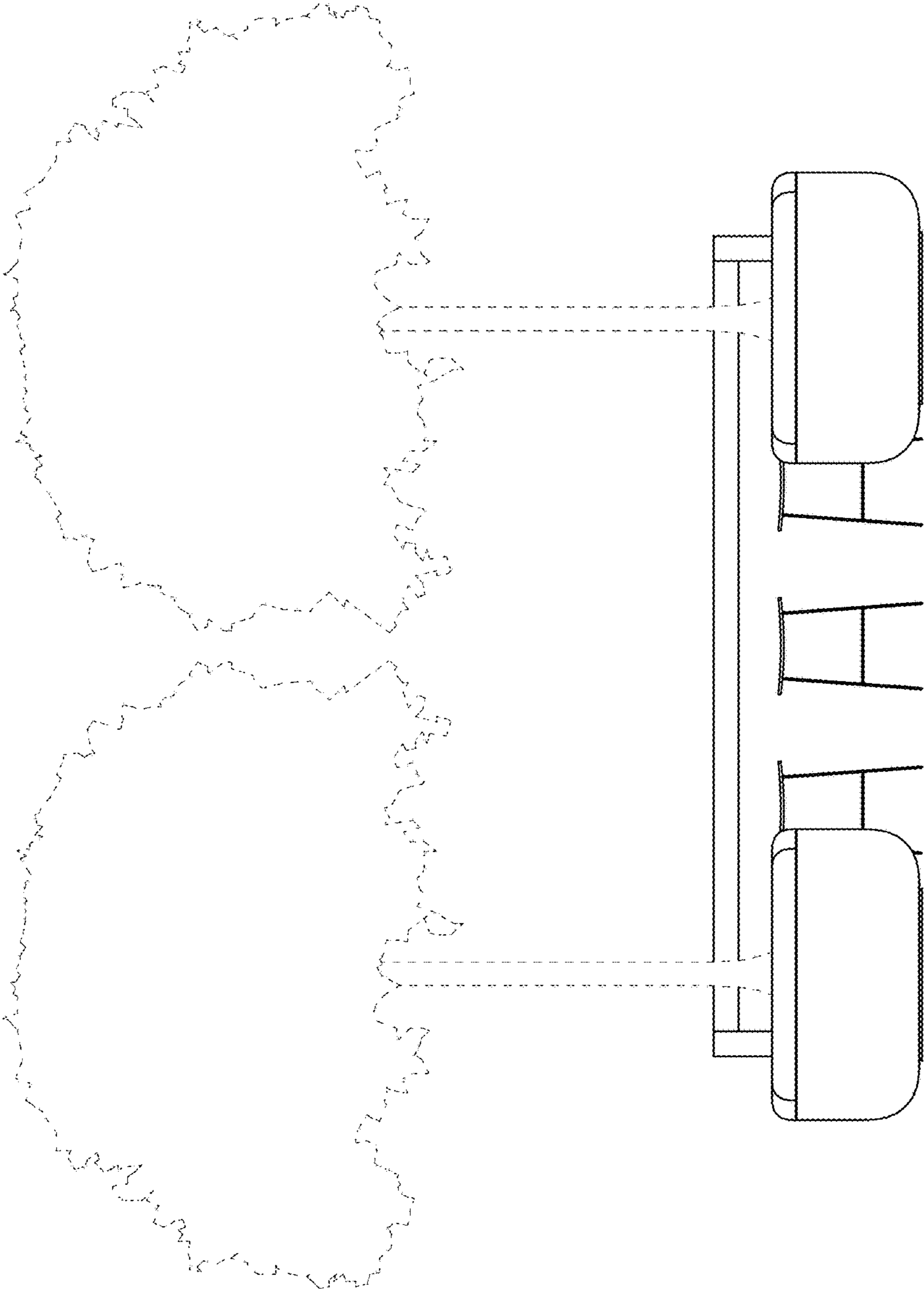

FIG. 2

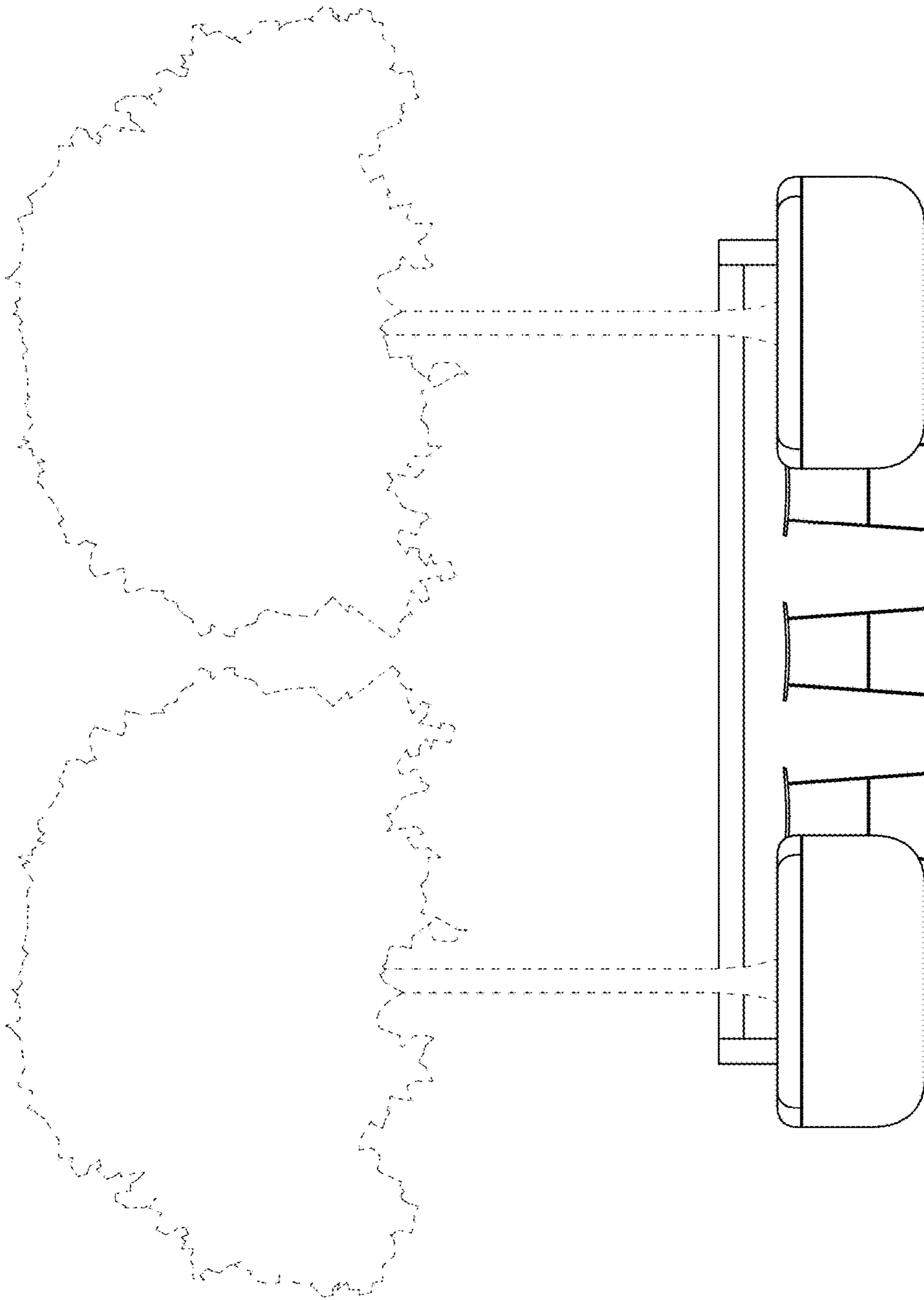

FIG. 3

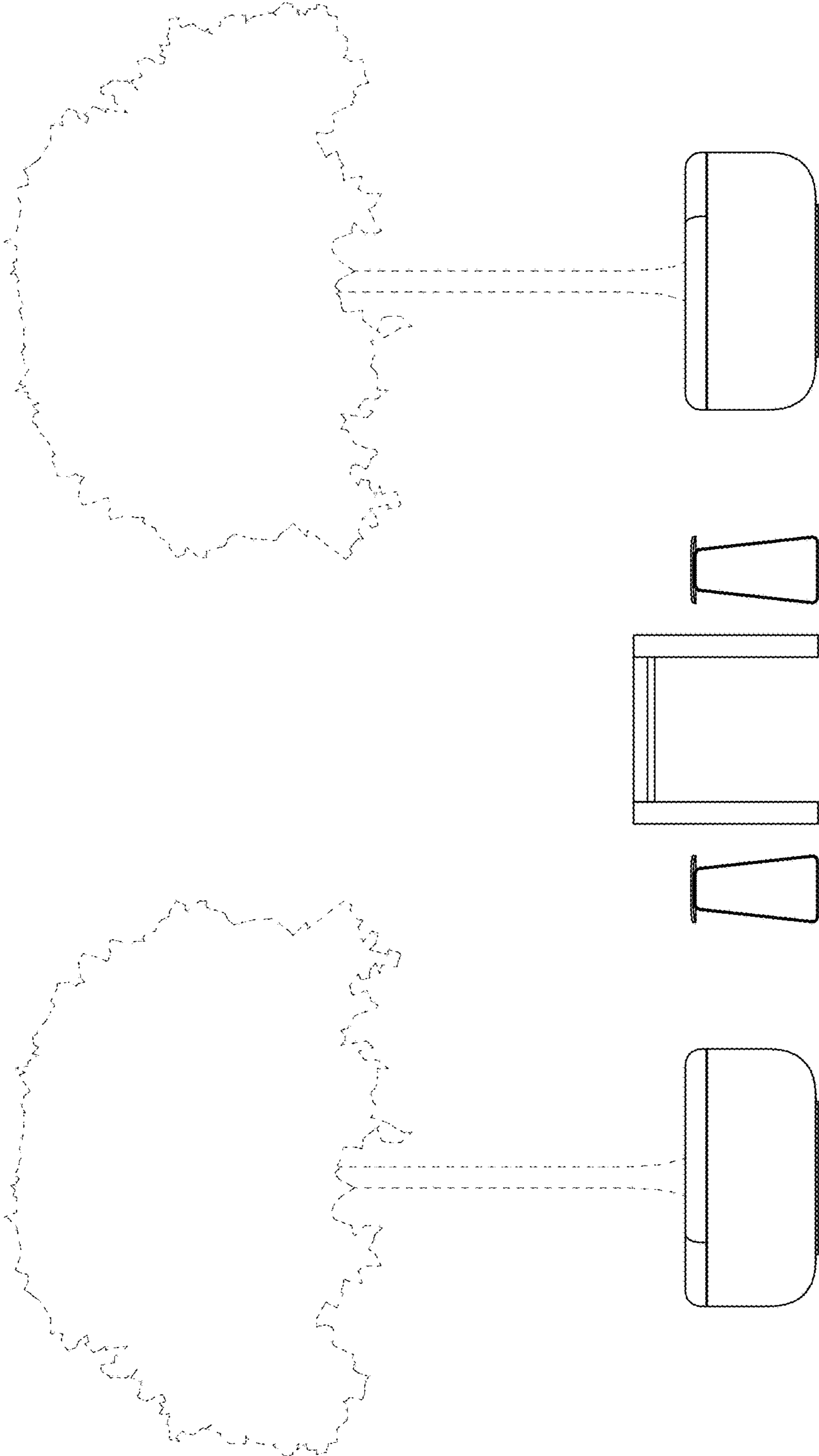

FIG. 4

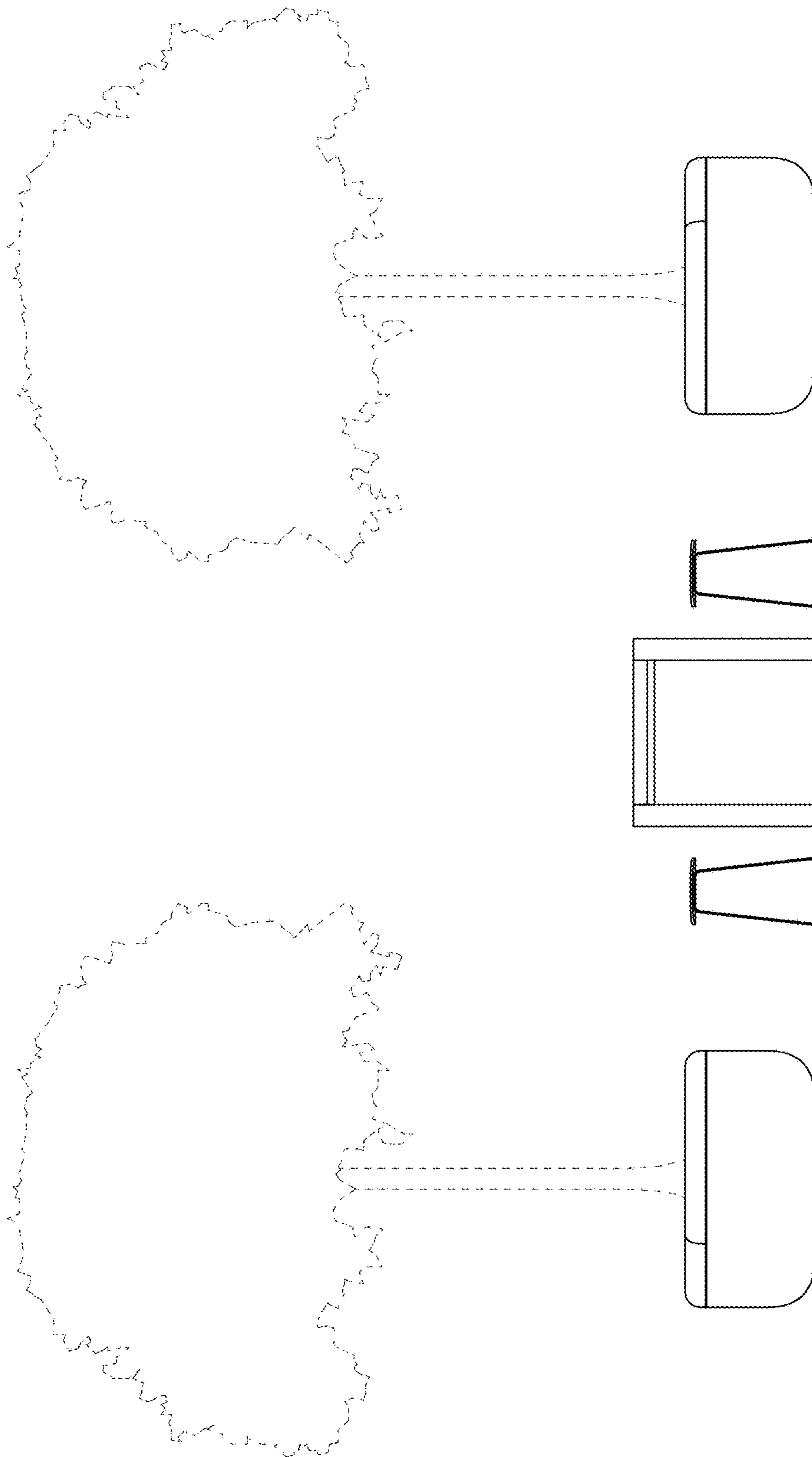

FIG. 5

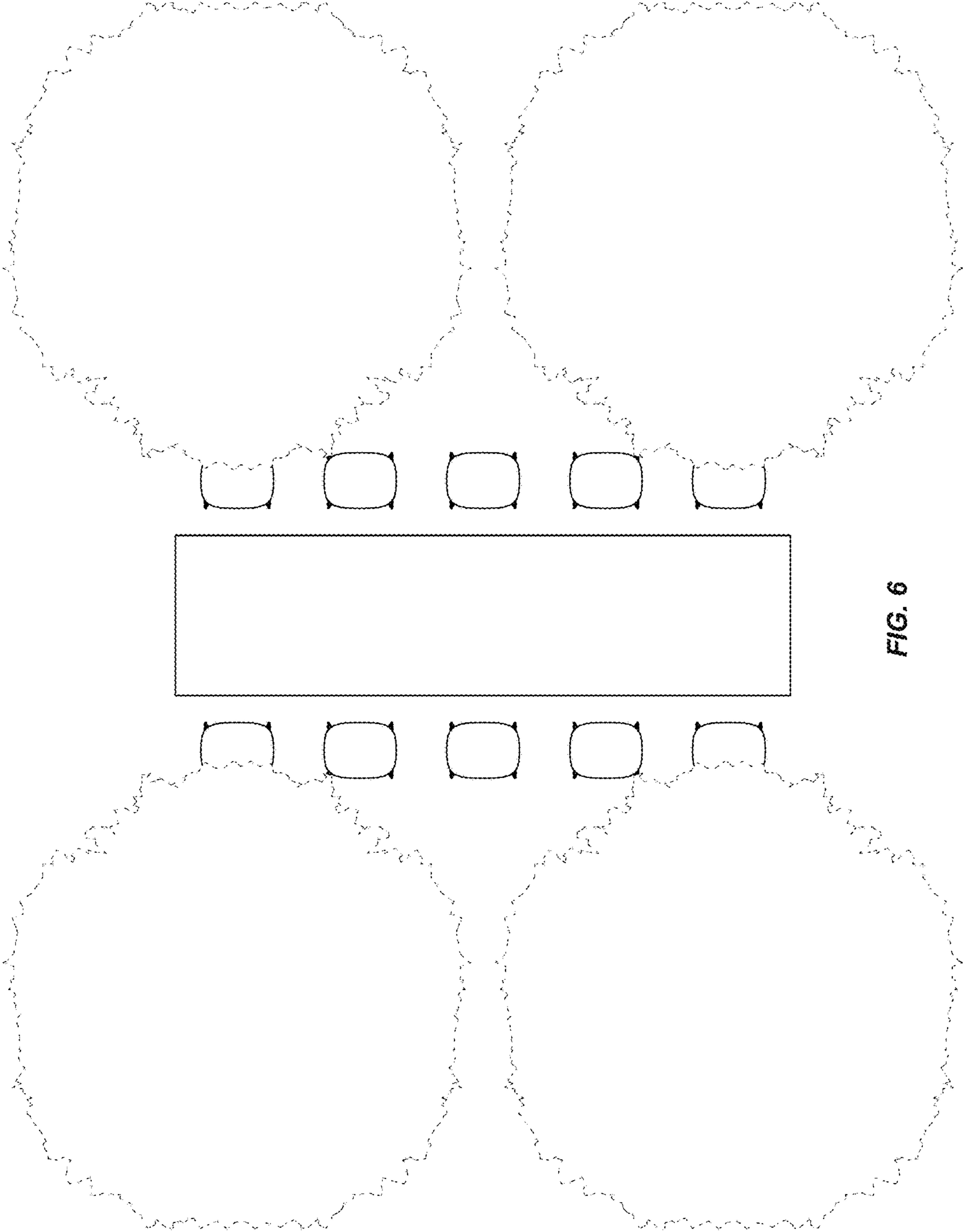

FIG. 6