



US00D824655S

(12) **United States Design Patent** (10) **Patent No.:** **US D824,655 S**  
**Gavrieli et al.** (45) **Date of Patent:** **\*\* Aug. 7, 2018**

(54) **GREEN SOLE AND HEEL STRIPE FOR SINGLE-SOLE SHOE**

OTHER PUBLICATIONS

(71) Applicant: **Gavrieli Brands, LLC**, Beverly Hills, CA (US)

Examination Report for AU 341324, 3 pgs., dated Oct. 24, 2012.

(Continued)

(72) Inventors: **Kfir Gavrieli**, Los Angeles, CA (US);  
**Dikla Gavrieli**, Los Angeles, CA (US)

*Primary Examiner* — Dominic V Simone

(74) *Attorney, Agent, or Firm* — Morgan, Lewis & Bockius LLP

(73) Assignee: **Gavrieli Brands LLC**, Beverly Hills, CA (US)

(57) **CLAIM**

The ornamental design for a green sole and heel stripe for a single-sole shoe, as shown and described.

(\*\*) Term: **15 Years**

**DESCRIPTION**

(21) Appl. No.: **29/570,620**

The file of this patent contains at least one drawing executed in color. Copies of this patent with color drawing(s) will be provided by the Office upon request and payment of the necessary fee.

(22) Filed: **Jul. 11, 2016**

**Related U.S. Application Data**

(63) Continuation of application No. 29/493,452, filed on Jun. 10, 2014, now Pat. No. Des. 761,533.

(51) **LOC (11) Cl.** ..... **02-99**

(52) **U.S. Cl.**  
USPC ..... **D2/971**

(58) **Field of Classification Search**  
USPC ..... D2/896, 900, 919-921, 925, 939, 947,  
D2/950, 969, 971; 36/1, 83, 8.1-8.3, 9 R,  
36/45-58, 104, 108, 76 R

(Continued)

(56) **References Cited**

**U.S. PATENT DOCUMENTS**

249,086 A 11/1881 Pienovi  
773,850 A 11/1904 Cooper et al.

(Continued)

**FOREIGN PATENT DOCUMENTS**

DE 20 2006 000230 U1 5/2007  
GB 2443937 A 5/2008

(Continued)

FIG. 1 is a perspective view of a green sole and heel stripe for a single-sole shoe shaded to show the color green, showing our new design;  
FIG. 2 is a first side view thereof;  
FIG. 3 is a second side view thereof;  
FIG. 4 is a top view thereof;  
FIG. 5 is a bottom view thereof;  
FIG. 6 is a front view thereof;  
FIG. 7 is a back view thereof;  
FIG. 8 is a perspective view of a second embodiment of our new design of a green sole and heel stripe for single-sole shoe, where the green portions are indicated using the USPTO convention of solid diagonal lines extending from the upper left to the lower right for Green;  
FIG. 9 is a first side view thereof;  
FIG. 10 is a second side view thereof;  
FIG. 11 is a top view thereof  
FIG. 12 is a bottom view thereof;  
FIG. 13 is a front view thereof; and,  
FIG. 14 is a back view thereof.

The broken lines illustrating the shoe upper are for environmental purposes only and form no part of the claimed design.

**1 Claim, 12 Drawing Sheets**  
**(6 of 12 Drawing Sheet(s) Filed in Color)**

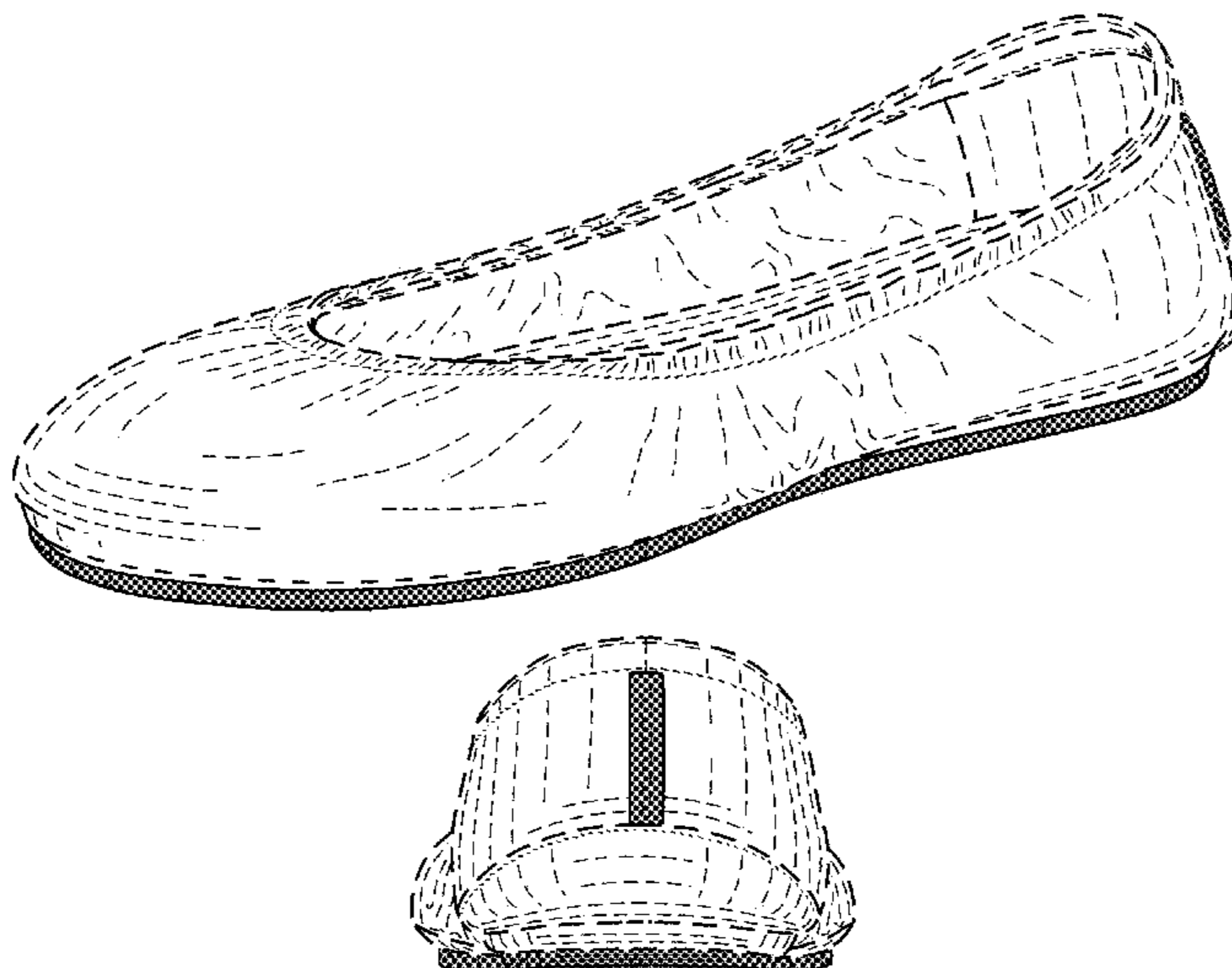

(58) **Field of Classification Search**  
 CPC ..... A43B 21/00; A43B 21/02; A43B 21/06;  
 A43B 9/14; A43B 1/0045; A43B 13/10;  
 A43B 13/12; A43B 23/06; A43B 23/07;  
 A43B 1/0036; A43B 5/12  
 See application file for complete search history.

(56) **References Cited**

U.S. PATENT DOCUMENTS

830,941 A 9/1906 Walden  
 1,208,209 A 12/1916 Prince  
 1,214,666 A 2/1917 Ford  
 1,519,009 A 12/1924 Reina  
 1,525,848 A \* 2/1925 Bonaventure ..... A43B 5/12  
 36/113  
 1,587,377 A 6/1926 Grosjean  
 1,650,466 A 11/1927 Righter  
 2,224,590 A 12/1940 Boivin  
 2,268,777 A 1/1942 Scholl  
 D133,819 S \* 9/1942 Harris ..... D2/939  
 D135,791 S 6/1943 Beebe  
 2,323,563 A 7/1943 Nugent  
 2,342,882 A 2/1944 Meltzer  
 D141,871 S 7/1945 Braun  
 2,383,585 A 8/1945 Bindner  
 D149,685 S \* 5/1948 Sandler ..... D2/935  
 D150,729 S \* 8/1948 Sandler ..... D2/923  
 D166,090 S \* 3/1952 Maling ..... D2/897  
 2,772,488 A 12/1956 Meltzer  
 2,904,814 A 9/1959 Scholl  
 3,148,378 A 9/1964 Tibbitts  
 D200,897 S \* 4/1965 Mitchell ..... D2/919  
 D220,464 S 4/1971 Hayoshi  
 D247,396 S \* 3/1978 Schlerth ..... D2/939  
 4,412,393 A 11/1983 Terlizzi, Jr. et al.  
 D275,525 S 9/1984 Nakao  
 4,674,206 A 6/1987 Lyden  
 D295,692 S \* 5/1988 Zuidema ..... D2/950  
 D300,085 S 3/1989 Ito et al.  
 RE33,018 E 8/1989 Ostrander  
 4,899,412 A 2/1990 Ganon  
 D316,773 S 5/1991 Valle  
 5,012,541 A 5/1991 Ganon  
 D339,669 S \* 9/1993 Miller ..... D2/919  
 5,282,326 A 2/1994 Schroer, Jr. et al.  
 5,421,050 A 6/1995 Laganas  
 5,699,629 A 12/1997 Munsch  
 5,746,014 A 5/1998 Tanemoto  
 D420,785 S 2/2000 Perez  
 6,055,745 A 5/2000 Endoh  
 6,076,284 A 6/2000 Terlizzi  
 6,189,239 B1 2/2001 Gasparovic et al.  
 6,338,207 B1 1/2002 Chang  
 D457,292 S \* 5/2002 Sessa ..... D2/949  
 D461,947 S 8/2002 Merceron  
 6,588,124 B2 6/2003 Morrone  
 D476,798 S 7/2003 Reynolds et al.  
 D498,041 S 11/2004 McClaskie  
 D500,191 S \* 12/2004 Belley ..... D2/969  
 D501,706 S 2/2005 McClaskie  
 6,857,203 B2 2/2005 Minden  
 6,895,693 B2 5/2005 Baruck  
 6,978,557 B2 12/2005 Lee  
 7,032,327 B1 4/2006 Tartaglia et al.  
 7,036,244 B1 5/2006 Finch  
 D527,513 S 9/2006 Della Valle  
 D529,513 S \* 10/2006 Aketa ..... D15/5  
 D531,790 S 11/2006 Wurzburg  
 D534,341 S \* 1/2007 Choi ..... D2/896  
 D542,513 S 5/2007 Amado et al.  
 D556,990 S 12/2007 Cabados  
 7,337,558 B2 3/2008 Terlizzi et al.  
 D567,485 S 4/2008 James  
 D570,488 S 6/2008 Kirksey et al.  
 D571,084 S 6/2008 Comeau  
 D571,548 S 6/2008 Seamans

D571,989 S 7/2008 Siegal  
 D580,640 S 11/2008 Wurzburg  
 D582,638 S 12/2008 Ringholz  
 7,496,982 B2 3/2009 Clark et al.  
 7,506,459 B2 3/2009 Grisoni et al.  
 D591,031 S 4/2009 Cofinco  
 D593,295 S \* 6/2009 Belley ..... D2/969  
 D593,297 S \* 6/2009 Belley ..... D2/969  
 D593,307 S \* 6/2009 Belley ..... D2/969  
 D599,093 S \* 9/2009 Issler ..... D2/925  
 D604,030 S 11/2009 Wilson  
 D607,194 S 1/2010 Zagula  
 D610,332 S 2/2010 Raichle  
 D610,785 S 3/2010 Smith  
 D612,140 S 3/2010 Moon  
 D612,141 S 3/2010 Moon  
 7,694,435 B1 4/2010 Kiser et al.  
 D615,737 S 5/2010 Feller  
 7,735,244 B1 6/2010 Ameche  
 7,743,530 B2 6/2010 Truelsen  
 D618,891 S 7/2010 McClaskie  
 7,757,408 B2 7/2010 McClaskie  
 D630,829 S 1/2011 Weisner  
 D632,881 S 2/2011 Rosenberg  
 7,926,203 B2 4/2011 Wilkenfeld  
 7,966,747 B2 6/2011 Wilkenfeld et al.  
 D640,861 S 7/2011 Wilkenfeld  
 8,020,320 B2 9/2011 Gillespie  
 8,127,468 B2 3/2012 Morgan  
 D657,543 S 4/2012 Bove  
 D659,960 S 5/2012 Bizzo  
 8,230,619 B2 7/2012 Salvatelli  
 D664,755 S 8/2012 Gavrieli et al.  
 D665,157 S 8/2012 Wu  
 8,240,067 B2 8/2012 Sussmann  
 8,245,420 B2 8/2012 Wilson  
 D668,027 S 10/2012 Millieret  
 D668,438 S 10/2012 Millieret  
 D668,847 S \* 10/2012 Gavrieli ..... D2/925  
 D668,848 S \* 10/2012 Gavrieli ..... D2/925  
 D668,849 S 10/2012 Pozzi  
 D668,850 S 10/2012 Pozzi  
 D672,542 S 12/2012 Gray et al.  
 D676,634 S \* 2/2013 Gavrieli ..... D2/925  
 D681,927 S \* 5/2013 Gavrieli ..... D2/925  
 D681,928 S \* 5/2013 Gavrieli ..... D2/925  
 D681,929 S \* 5/2013 Gavrieli ..... A43B 3/248  
 D2/925  
 D683,936 S \* 6/2013 Gavrieli ..... D2/925  
 8,468,723 B2 6/2013 Malka-Harari  
 D686,812 S 7/2013 Gavrieli et al.  
 8,510,975 B2 8/2013 Krikelis  
 D688,853 S \* 9/2013 Gavrieli ..... A43B 3/248  
 D2/925  
 D688,854 S \* 9/2013 Gavrieli ..... A43B 3/248  
 D2/925  
 D688,855 S \* 9/2013 Gavrieli ..... A43B 3/248  
 D2/925  
 D689,270 S \* 9/2013 Gavrieli ..... A43B 3/248  
 D2/925  
 D689,271 S \* 9/2013 Gavrieli ..... A43B 3/248  
 D2/925  
 D689,272 S \* 9/2013 Gavrieli ..... A43B 3/248  
 D2/925  
 D690,914 S \* 10/2013 Gavrieli ..... A43B 3/248  
 D2/925  
 D690,915 S \* 10/2013 Gavrieli ..... D2/925  
 D696,500 S 12/2013 Hunt  
 D699,424 S 2/2014 Hamm  
 8,661,714 B2 3/2014 Sussmann  
 8,745,893 B2 6/2014 Gavrieli et al.  
 8,973,287 B2 3/2015 Shibata  
 D761,533 S \* 7/2016 Gavrieli ..... D2/939  
 2002/0078591 A1 6/2002 Morrone  
 2002/0129519 A1 9/2002 Cahan  
 2003/0070319 A1 4/2003 Minden  
 2003/0121176 A1 7/2003 Baruck  
 2004/0025377 A1 2/2004 Brannon



(56)

## References Cited

## U.S. PATENT DOCUMENTS

2005/0022421	A1	2/2005	Bruckner
2005/0115115	A1	6/2005	Lacey
2005/0217148	A1	10/2005	Connolly et al.
2005/0262734	A1	12/2005	Cheng
2006/0086005	A1	4/2006	Yerian
2006/0156576	A1	7/2006	Sloan
2007/0074424	A1	4/2007	Lin
2007/0204482	A1	9/2007	Gibson-Collinson
2007/0204483	A1	9/2007	Kirsch et al.
2008/0052964	A1	3/2008	Taylor
2008/0086912	A1	4/2008	Wilkenfeld
2008/0110059	A1	5/2008	Kuramoto et al.
2009/0019732	A1	1/2009	Sussmann
2009/0193685	A1	8/2009	Wilson
2009/0205222	A1	8/2009	Mclinden
2009/0272009	A1	11/2009	Weisner et al.
2010/0011625	A1	1/2010	Percival
2010/0018080	A1	1/2010	Smith
2010/0050469	A1	3/2010	Chen
2010/0095557	A1	4/2010	Jarvis
2010/0115793	A1	5/2010	Kraisosky
2010/0122475	A1	5/2010	Purrington
2010/0146822	A1	6/2010	MacGregor
2010/0212186	A1	8/2010	Cheng
2010/0275462	A1	11/2010	Pucci
2010/0281713	A1	11/2010	Pantazes
2015/0089843	A1	4/2015	Gavrieli

## FOREIGN PATENT DOCUMENTS

GB	2 446 205 A	8/2008
TW	D119165	10/2007

## OTHER PUBLICATIONS

Letter from TMI and Associates with Office Action, 2 pgs, dated Sep. 19, 2012 <http://www.payless.com/store/?&TLC=Womens&SLC=WomensNewArrivals>

&BLC=WomensNewArrivalsNewArrivals&With+Regular  
&ItemCode=60131&LotNumber=062642&Type=Adult  
&Popularity=637&Descriptvein.

Taiwanese Office Action for TW 101300726, 10 pgs., dated Sep. 6, 2012.

“The Love List, Ticks by Gavrieli—Foldable Ballet Flats,” <http://thelovelist-carly.blogspot.com/au/2010/09/ticks-by-gavrieli-foldable-ballet.html>, 3 pgs., Sep. 12, 2010.

“Ticks by Gavrieli,” <http://ticks.com>, 1 pg., retrieved Mar. 13, 2013 from URL.

“Try It Mummy!, Ticks by Gavrieli,” <http://tryitmummy.blogspot.com.au/2010/12/ticks-by-gavrieli.html>, 4 pgs., Dec. 9, 2010.

“Wearability—Real People Style, What came first, the City Flat or the Ticks,” <http://wearability.posterous.com/what-came-first-the-city-flat-or-the-ticks>, 4 pgs., Aug. 29, 2010.

“The Ballet Flat . . . Reinvented; Ballet Flats . . . with a Bonus; Step Into Ticks; Going Places? Take Ticks,” <http://web.archive.org/web/2010052004346/http://www.ticks.com/>; 4 pgs., May 24, 2010.

“Ticks—Comfortable designer flats you can fit in your purse and wear all day, every day,” <http://web.archive.org/web/20110731151555/http://ticks.com/>; 6 pgs., Jul. 31, 2011.

“58th Annual Emmy Awards,” [http://spoonsforksandfashion.blogspot.com/2006\\_08\\_01\\_archive.html](http://spoonsforksandfashion.blogspot.com/2006_08_01_archive.html), depicting Nine West flats, 11 pgs., Aug. 1, 2006.

Pictures of Nine West flats sold in 2006, 3 pgs.

“I Love a Good Ballet Flat!,” <http://dressupfiles.com/i-love-a-good-ballet-flat>, depicting Sue London flats, 4 pgs., Sep. 3, 2010.

Pictures of Sue London flats sold in 2010, 2 pgs.

“Miss Cathie Reviews: The Yosi Samra Foldable Ballet Flat . . .,” <http://www.misscathie.com/2010/01/miss-cathie-reviews-the-yosi-samra-foldable-ballet-flat/>, depicting Yosi Samra flats, 7 pgs., Jan. 2010.

Pictures of Yosi Samra flats sold in 2010, 2 pgs.

“Goodbye two thousand ten,” [http://emmajoyrussell.blogspot.com/2010\\_12\\_01\\_archive.html](http://emmajoyrussell.blogspot.com/2010_12_01_archive.html), depicting Gap flats, 39 pgs., Dec. 1, 2010.

Pictures of Gap flats available for sale in 2010, 9 pgs.

“Our newest design of folding flats—Pink,” <https://fitinclouds.wordpress.com/2010/05/16/our-newest-design-of-folding-flats-pink/>, depicting Fit in Clouds flats, 1 pg., May 16, 2010.

“Fit in Clouds Satin Folding Shoes,” <http://www.goodhousekeeping.com/product-reviews/clothing/best-ballet-flats/fit-in-clouds-satin-foldable-ballet-flats>, depicting Fit in Clouds flats, 1 pg., Aug. 2013.

Pictures of Fit in Clouds flats available for sale in 2011, 4 pgs.

“Shoes for Standing,” <https://truthinshoes.wordpress.com/2008/07/>, depicting Sam & Libby flats, 2 pgs., Jul. 31, 2008.

“Target Designer Collaboration: Announcing Sam & Libby Shoes for Target,” <http://www.therecessionista.com/2012/11/target-designer-collaboration-announcing-sam-libby-shoes-for-target.html>, depicting Sam & Libby flats, 1 pg., Nov. 26, 2012.

Pictures of Sam & Libby flats available for purchase in 2011, 5 pgs. “Save your soles with Citisoles ballet flats,” <http://glamazondiaries.com/2009/07/save-your-soles-with-citisoles-ballet-flats>, depicting Citisoles flats, 3 pgs., Jul. 2009.

Pictures of Citisoles flats available for purchase in 2009, 3 pgs.

“#16 Corso Como Delicious Pumps Review and Giveaway!,” <http://www.mommatoldmeblog.com/2011/01/16-corso-como-delicious-pumps-review.html>, depicting Corso Como flats, 8 pgs., Jan. 16, 2011.

Pictures of Corso Como flats available for sale in 2011, 3 pgs.

“Jil-sander-navy-lead-ballet-flats-product . . .,” [www.ebay.com](http://www.ebay.com), depicting Jil Sander flats, 4 pgs., Nov. 2013.

Pictures of Jil Sander flats available for sale in 2011, 3 pgs.

“Spare Soles: Shoes That Roll-up & Fold-up,” <http://herpackinglist.com/2011/01/spare-soles-shoes/>, depicting Spare Soles flats, 2 pgs., Jan. 2011.

Pictures of Spare Soles flats available for sale in 2011, 5 pgs.

The Original Rollable, Foldable ballet flats with matching wristlet—Spare Soles, <http://herpackinglist.com/2011/01/spare-soles-shoes/>, depicting Roll-Upz Spare Soles flats, 2 pgs., Jan. 2011.

Pictures of Roll-Upz by Spare Soles flats available for sale in 2011, 6 pgs.

“The Cutest Blog, Preppy 50 and Loving Lilly, Ballet Flat Delight,” <http://preppy50andlovinglilly.blogspot.com/2011/02/ballet-flat-delight.html>, depicting Henri Bendel flats, 13 pgs., Feb. 19, 2011.

Pictures of Henri Bendel flats available for sale in 2011, 4 pgs.

“Mumsnet by parents for parents,” [http://www.mumsnet.com/Talk/style\\_and\\_beauty/a1612000-Anyone-tried-Redfoot-Flatmates-foldable-ballet-pumps](http://www.mumsnet.com/Talk/style_and_beauty/a1612000-Anyone-tried-Redfoot-Flatmates-foldable-ballet-pumps), depicting Redfoot Flatmates flats, 1 pg, Nov. 14, 2012.

Pictures of Redfoot Flatmates flats available for sale in 2011, 6 pgs.

“Amazon.com: Customer Reviews: Bloch London Women’s Lux Ballet Flat,” <http://www.amazon.com/Bloch-London-Womens-Ballet-Flat/product-reviews/B004LWP7YW>, depicting Bloch London flats, 4 pgs., Dec. 11, 2011.

Pictures of Bloch London flats offered for sale in 2011, 11 pgs.

“h&m foldable leopard print flat,” <http://845shops.wordpress.com/2011/06/16/flats-for-7-bucks/shoe1/>, depicting h&m flats, 3 pgs., Jun. 16, 2011.

Pictures of h&m foldable flats offered for sale in 2011, 4 pgs.

“Seekyt—Juicy Couture Ballet Flats—Are They Worth the Money?,” <http://seekyt.com/juicy-couture-ballet-flats-are-they-worth-the-money/>, 14 pgs., Jun. 3, 2011.

Pictures of Juicy Couture flats offered for sale in 2011, 3 pgs.

“Purse Flats,” <http://purseflats.wordpress.com>, depicting Purse Flats by Erica Wilson, 3 pgs., Jul. 12, 2012.

Pictures of Purse Flats by Erica Wilson offered for sale in 2011, 6 pgs.

“Splash Page,” <http://web.archive.org/web/20100524004346/http://www.ticks.com/>, 4 pgs., May 24, 2010.

“Ticks—Comfortable, designer flats you can fit in your purse and wear all day, every day,” <http://web.archive.org/web/20110731151555/http://ticks.com/>, 6 pgs., Jul. 31, 2011.

(56)

**References Cited**

## OTHER PUBLICATIONS

“Tieks by Gavrieli—Comfortable, designer flats you can fit in your purse and wear all day . . . ,” <http://web.archive.org/web/20110202210649/http://www.tieks.com/>, 8 pgs., Feb. 2, 2011.

“Carolina M. M. Goncalves > Tieks by Gavrieli,” [http://m2.facebook.com/Tieks?v=timeline&filter=2&timecutoff=1406427986&page=17&sectionLoadingID=m\\_timeline\\_loading\\_div\\_1293868799\\_1262332800\\_8\\_17&timeend=1293868799&timestart=1262332800&tm=AQDOvqhWQPN\\_Nbwm&refid=17](http://m2.facebook.com/Tieks?v=timeline&filter=2&timecutoff=1406427986&page=17&sectionLoadingID=m_timeline_loading_div_1293868799_1262332800_8_17&timeend=1293868799&timestart=1262332800&tm=AQDOvqhWQPN_Nbwm&refid=17), 1 pg. Jan 26, 2010.

“The Shoes Oprah Would Wear to Work (if She Had to Walk),” <http://www.inc.com/30under30/christina-desmarais/kfir-gavrieli-and-elram-gavrieli-founders-of-tieks.html>, 8 pgs., Jul. 2, 2012.

“Tieks by Gavrieli,” [http://m2.facebook.com/Tieks?v=timeline&filter=2&timecutoff=1406427986&page=14&sectionLoadingID=m\\_timeline\\_loading\\_div\\_1293868799\\_1262332800\\_8\\_14&timeend=1293868799&timestart=1262332800&tm=AQDOvqhWQPN\\_Nbwm&refid=17](http://m2.facebook.com/Tieks?v=timeline&filter=2&timecutoff=1406427986&page=14&sectionLoadingID=m_timeline_loading_div_1293868799_1262332800_8_14&timeend=1293868799&timestart=1262332800&tm=AQDOvqhWQPN_Nbwm&refid=17), 4 pgs., Jan. 26, 2010.

“Mighty Life List, Sensible Shoes,” <http://mightygirl.com/2010/08/24/sensible-shoes/>, 10 pgs., Aug. 24, 2010.

“Find! Tieks: Fab & sexy flats for fall,” <http://thefabmom.com/2013/08/29/find-tieks-fab-sexy-flats-for-fall/>, 3 pgs. Aug. 29, 2013.

“Step into Tieks,” <http://sliceofpink.typepad.com/blog/2010/09/tieks-1.html>, 5 pgs., Sep. 22, 2010.

“In Need of Flat-Soled Shoes,” <http://sliceofpink.typepad.com/blog/2010/09/tieks-1.html>, 7 pgs., Oct. 3, 2010.

“Say Hello to the Flat Shoes You Need for Fall . . . All 88 of Them!”, Picture of Adam Tucker Shoe/Slipper, <https://www.facebook.com/search/top?q=adam%20shoes%20slipper>, last accessed Oct. 28, 2016, dated Oct. 1, 2013, 1 page.

Picture of Adam Tucker Rainbow Shoes, <https://www.facebook.com/search/top?q=adam%20shoes%20rainbow>, last accessed Oct. 28, 2016, dated Aug. 14, 2013, 1 page.

\* cited by examiner



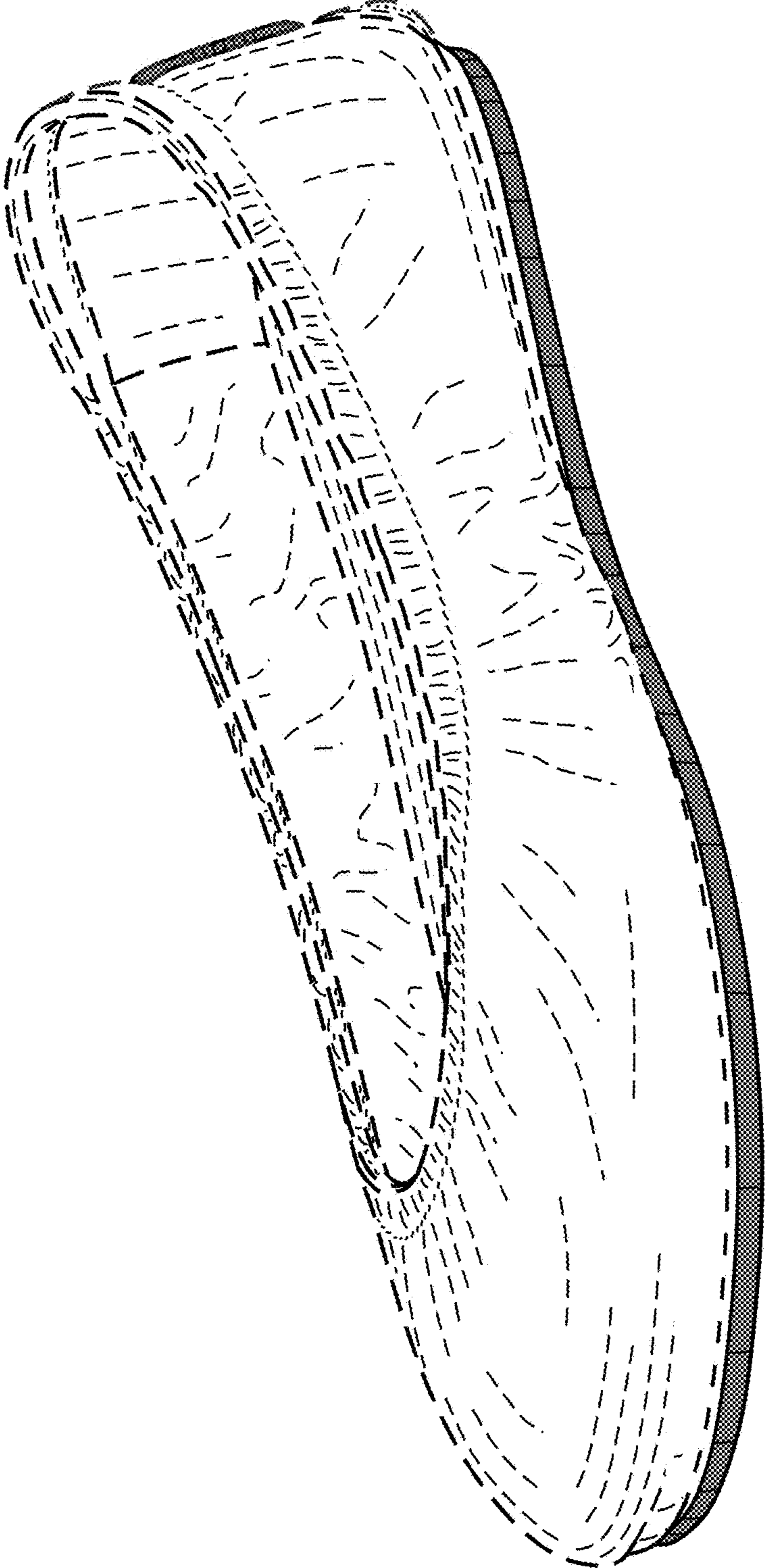

FIG. 1

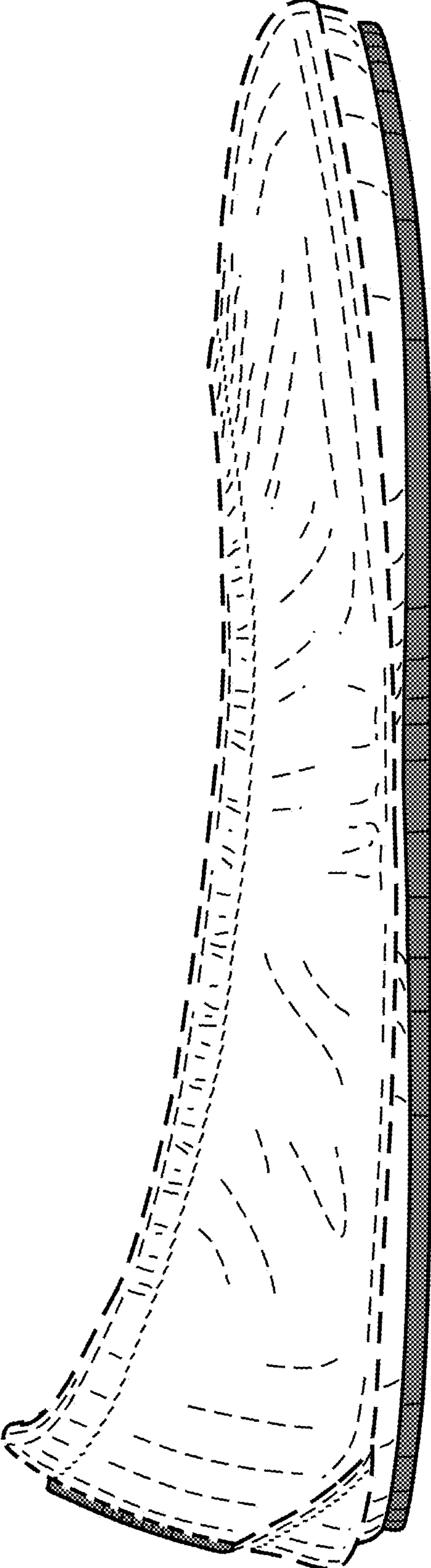

FIG. 2

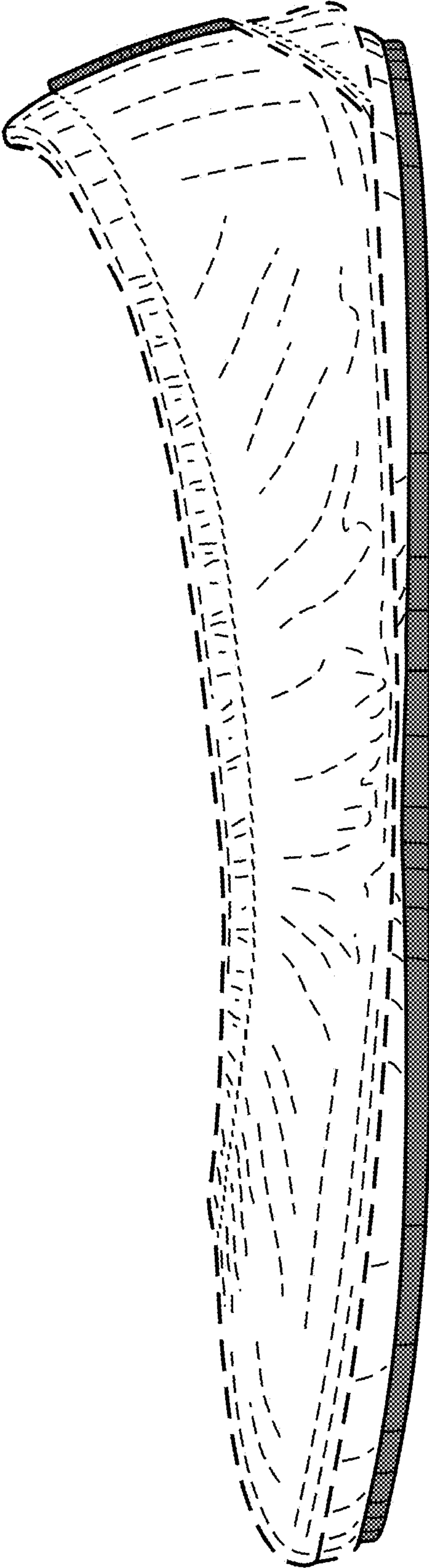

FIG. 3

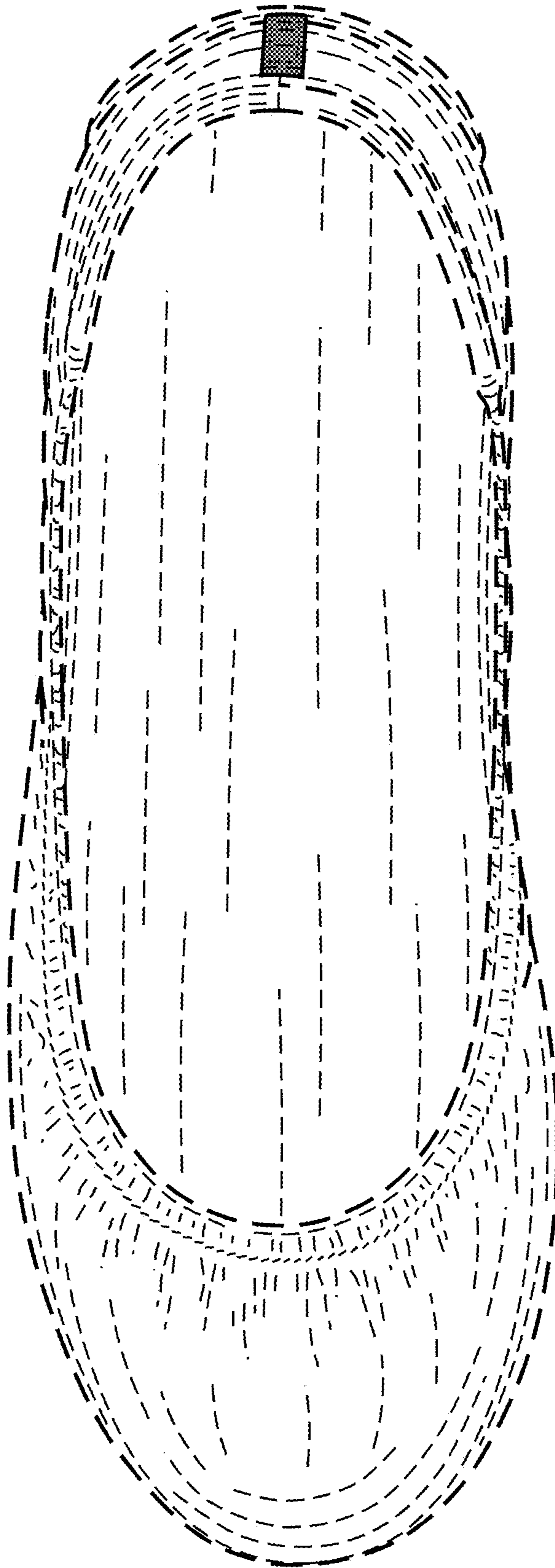

FIG. 4



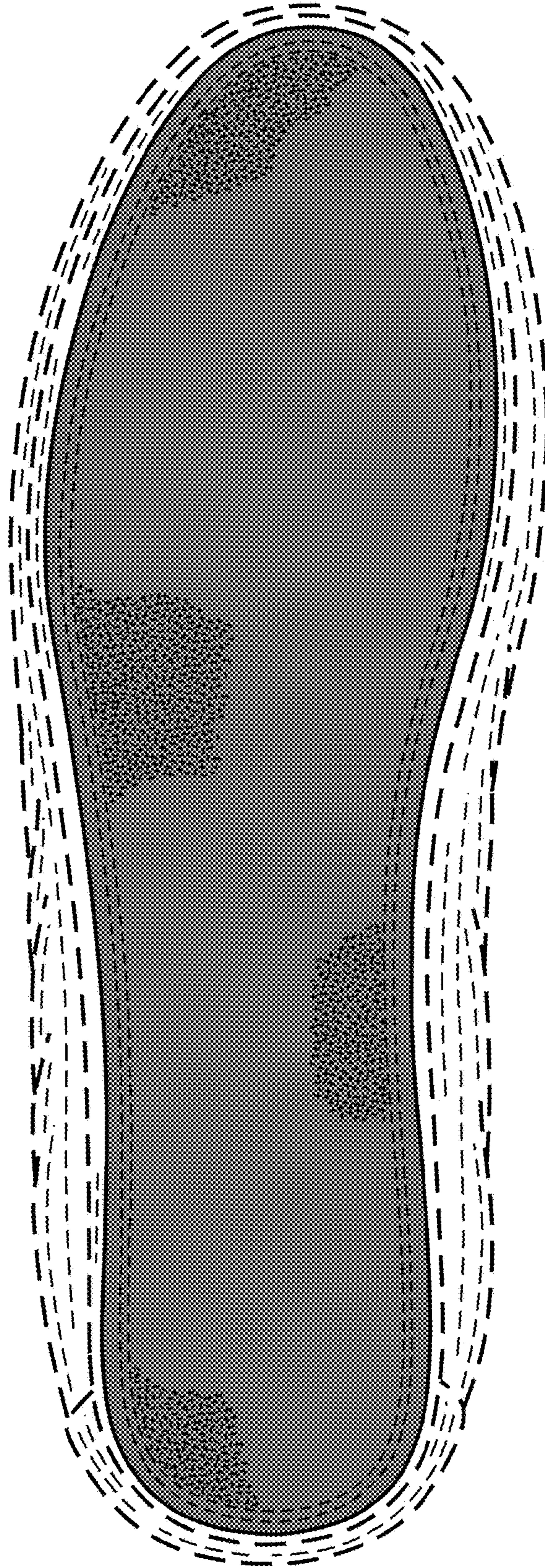

FIG. 5

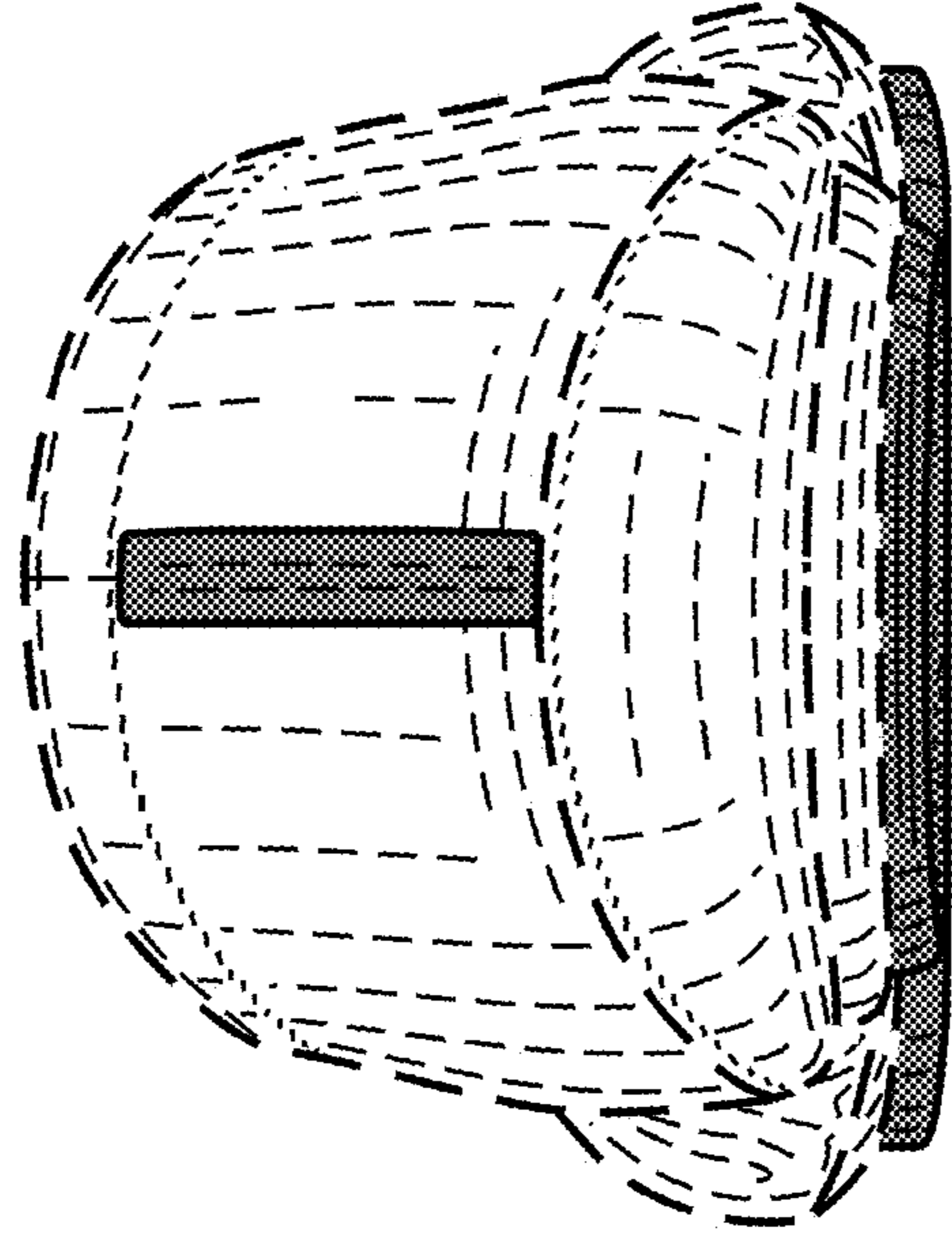

FIG. 6

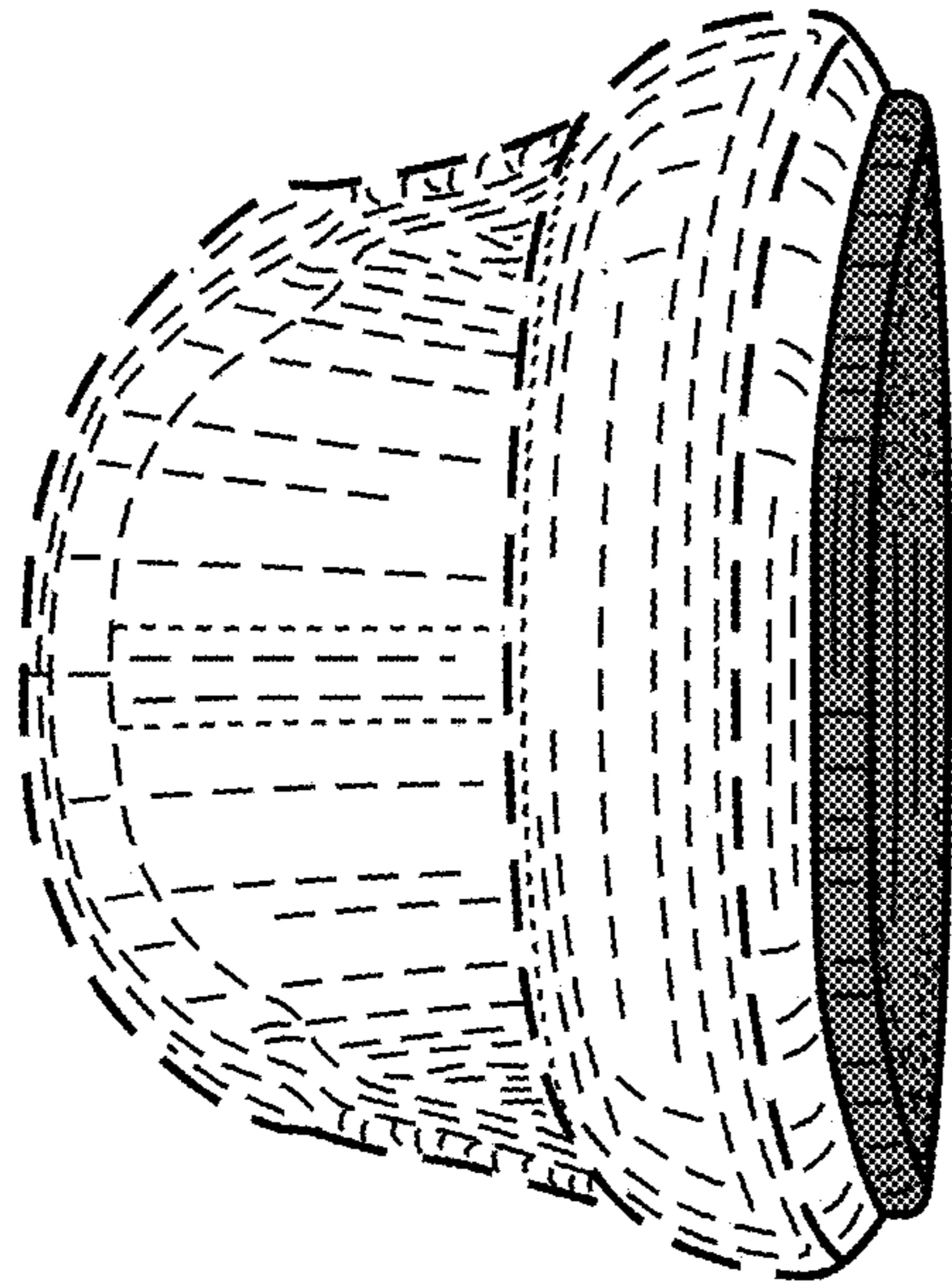

FIG. 7



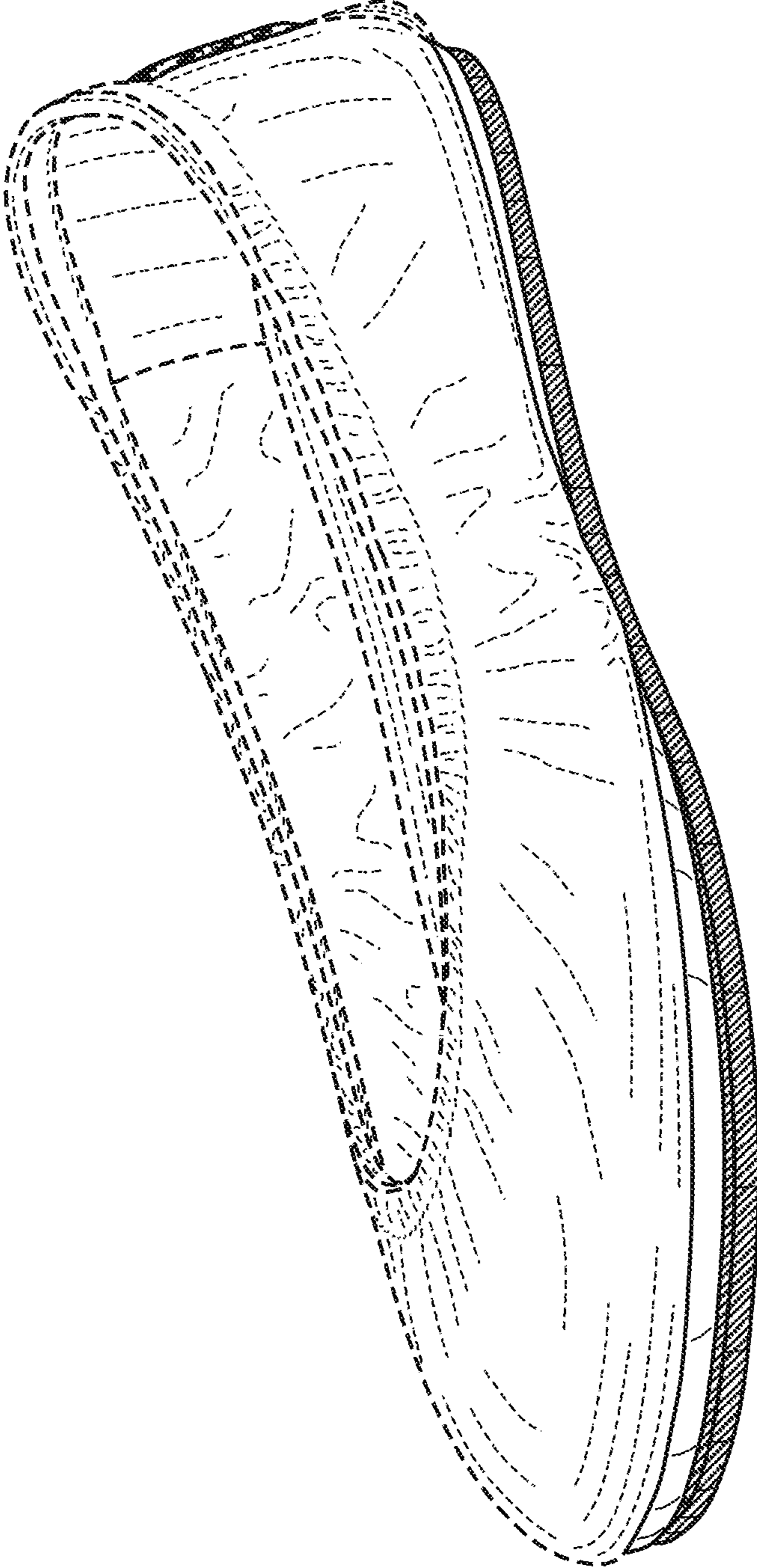

FIG. 8

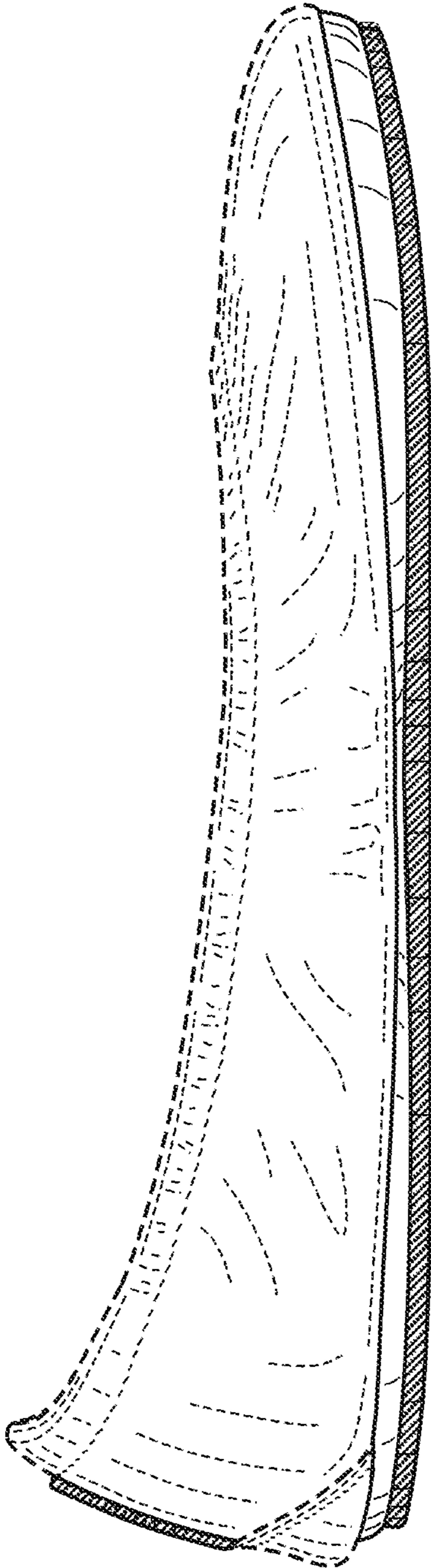

FIG. 9



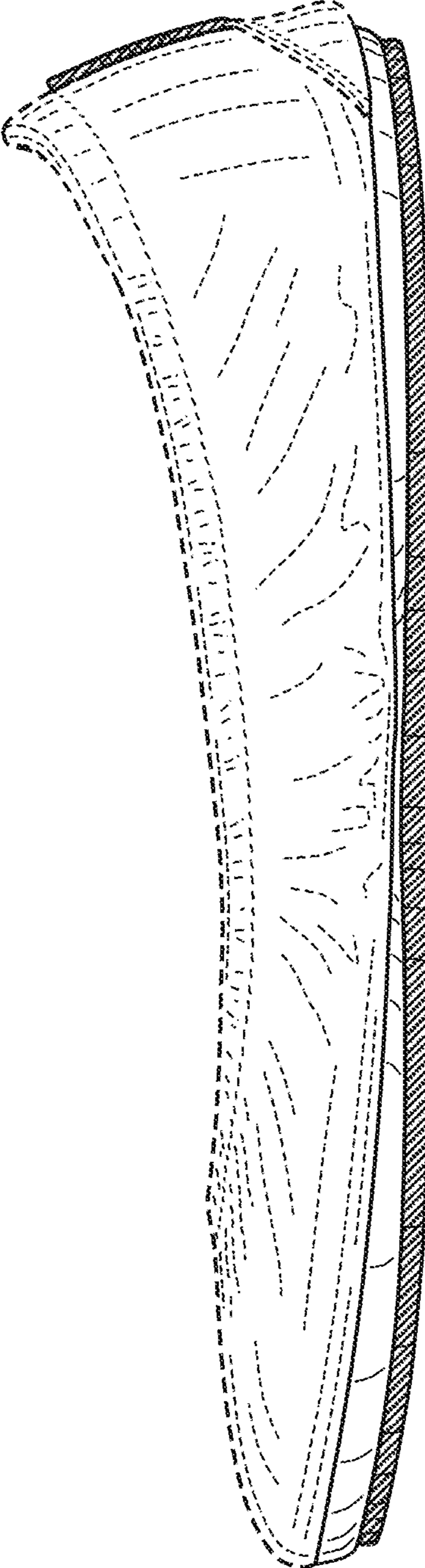

FIG. 10

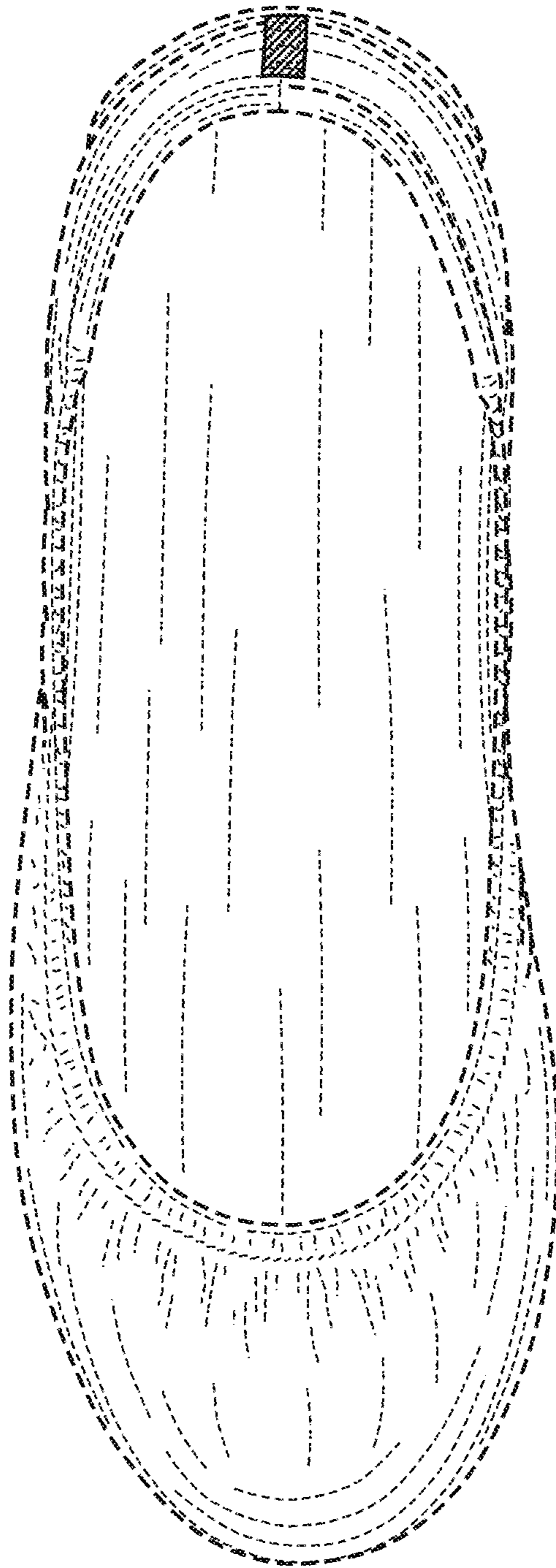

FIG. 11



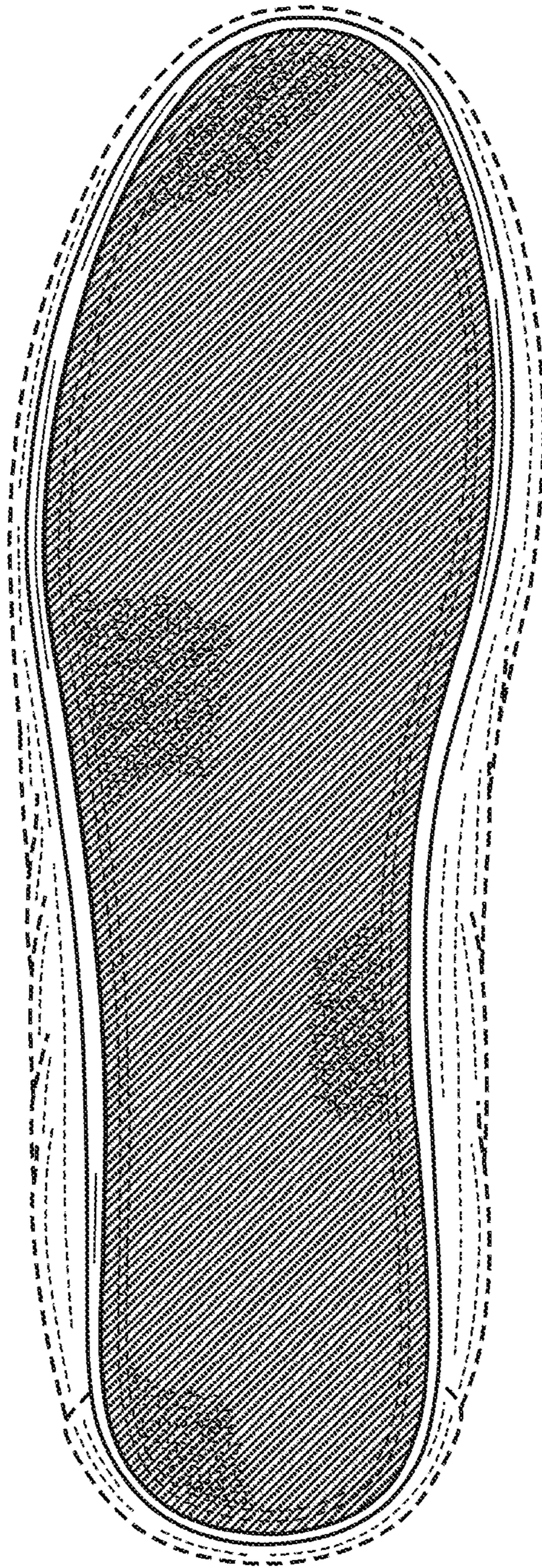

FIG. 12

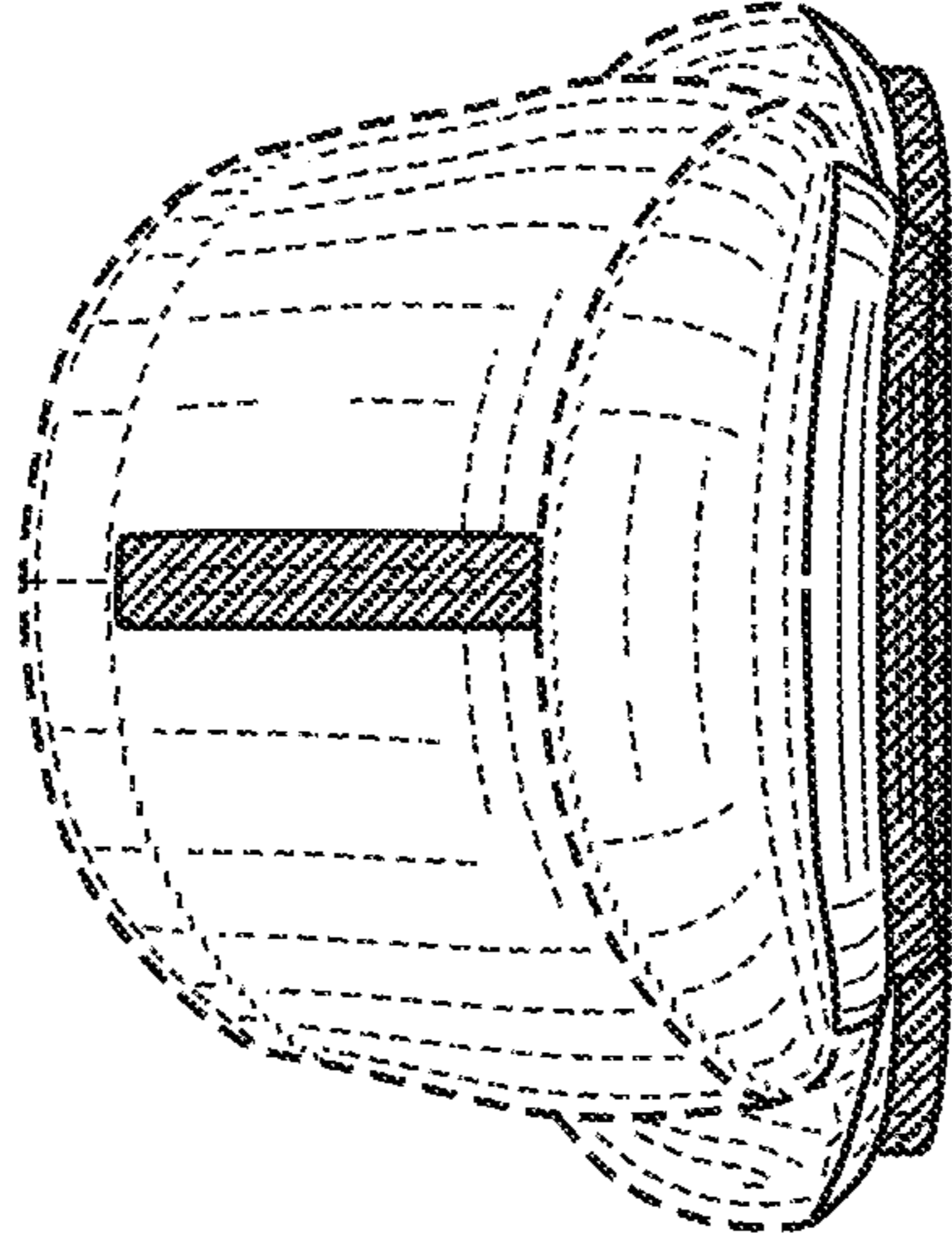

FIG. 14

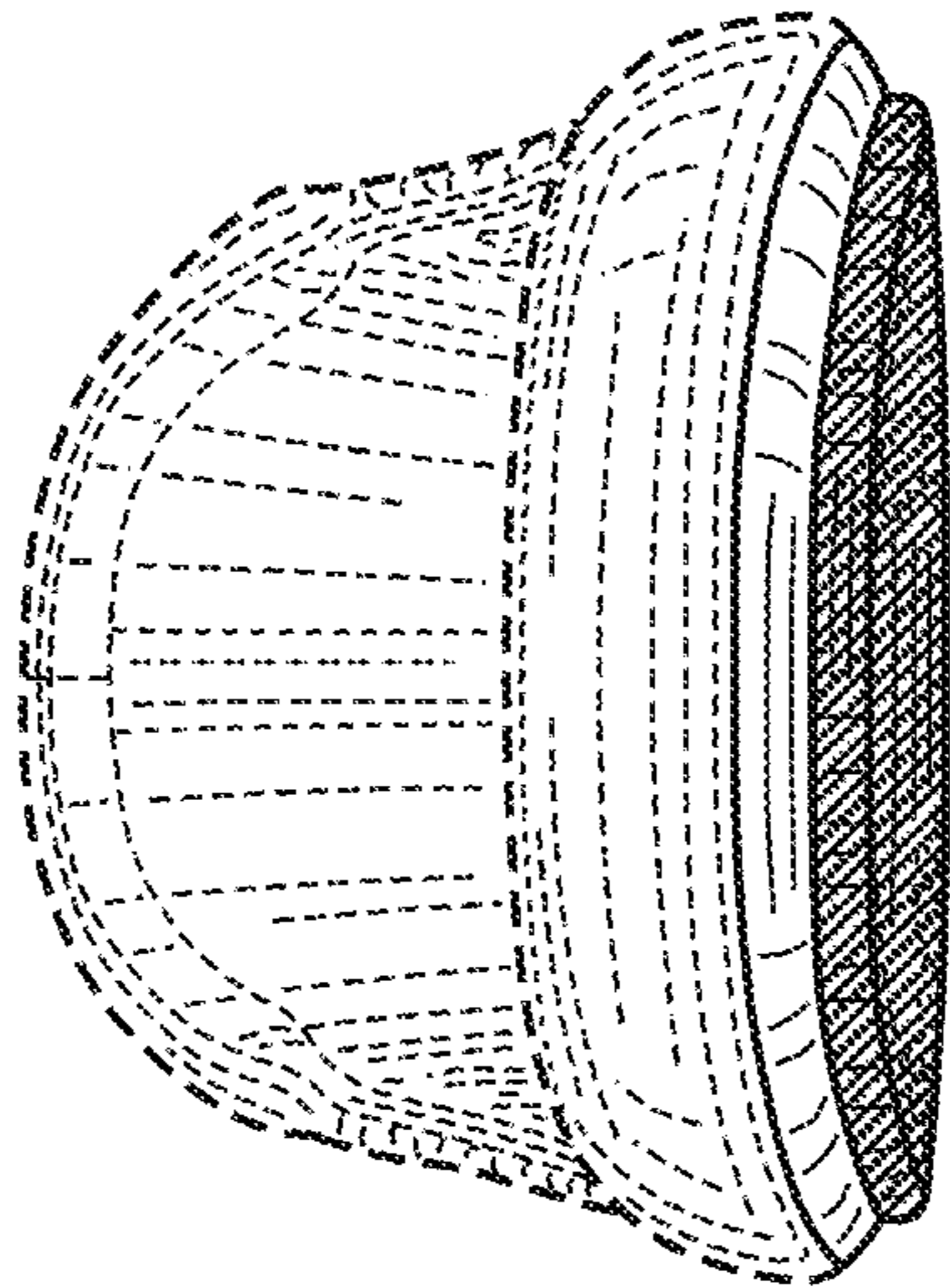

FIG. 13