



US00D824534S

(12) **United States Design Patent**
Kelly

(10) **Patent No.:** **US D824,534 S**
(45) **Date of Patent:** **** Jul. 31, 2018**

(54) **REAGENT RESERVOIR LINER**
(71) Applicant: **Integra Biosciences AG**, Zizers (CH)
(72) Inventor: **Terrence Kelly**, Lowell, MA (US)
(73) Assignee: **Integra Biosciences AG** (CH)
(**) Term: **15 Years**
(21) Appl. No.: **29/607,970**
(22) Filed: **Jun. 19, 2017**
(51) **LOC (11) Cl.** **24-02**
(52) **U.S. Cl.**
USPC **D24/224**
(58) **Field of Classification Search**
USPC D24/216, 224–227, 229, 231–233;
D3/203.1–203.8, 304, 313; D7/553.3;
D9/425, 431, 432, 456, 520, 732
(Continued)

(56) **References Cited**
U.S. PATENT DOCUMENTS
3,819,505 A * 6/1974 Parent G01N 27/44756
422/430
4,721,679 A * 1/1988 Yiu B01L 3/5085
220/23.8
(Continued)

OTHER PUBLICATIONS
VistaLab Technologies Reagent Reservoirs, <https://vistalab.com/>
Reagent Reservoirs, website visited Jun. 26, 2017.
Primary Examiner — Ian Simmons
Assistant Examiner — Mark Cavanna
(74) *Attorney, Agent, or Firm* — Andrus Intellectual
Property Law, LLP

(57) **CLAIM**
The ornamental design for a reagent reservoir liner, as shown and described.

DESCRIPTION
FIG. 1 is a perspective view of a first embodiment of a reagent reservoir liner showing the new design;
FIG. 2 is a top plan view of the first embodiment;
FIG. 3 is a right side elevation view of the first embodiment;
FIG. 4 is a left side elevation view of the first embodiment;
FIG. 5 is a front side elevation view of the first embodiment;
FIG. 6 is a rear side elevation view of the first embodiment;
FIG. 7 is a bottom plan view of the first embodiment;
FIG. 8 is a detailed view of the region encircled by arrows 8-8 in FIG. 1, illustrating in perspective a grouping of channels on an upper surface of a floor of the liner;
FIG. 9 is a top plan view of the region shown in FIG. 8;
FIG. 10 is a cross sectional view taken along line 10-10 in FIG. 9;
FIG. 11 is a perspective view of a second embodiment of a reservoir liner showing the new design;
FIG. 12 is a top plan view of the second embodiment;
FIG. 13 is a right side elevation view of the second embodiment;
FIG. 14 is a left side elevation view of the second embodiment;
FIG. 15 is a front side elevation view of the second embodiment;
FIG. 16 is a rear side elevation view of the second embodiment;
FIG. 17 is a bottom plan view of the second embodiment;
FIG. 18 is a detailed view of the region encircled by arrows 18-18 in FIG. 11, illustrating in perspective a grouping of channels on an upper surface of a floor of the liner;
FIG. 19 is a top plan view of the region shown in FIG. 18; and,
FIG. 20 is a cross sectional view taken along line 20-20 in FIG. 19.

1 Claim, 12 Drawing Sheets

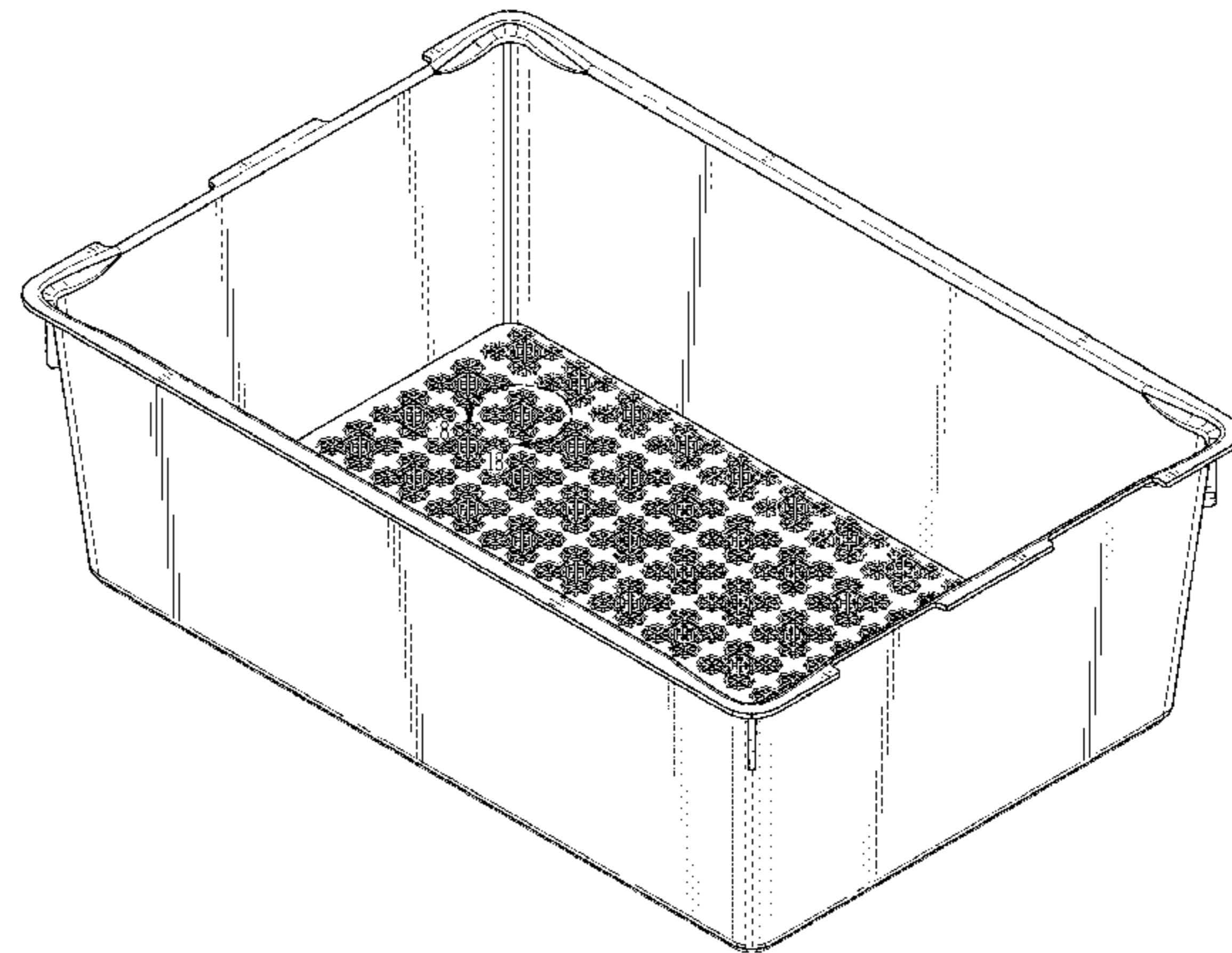
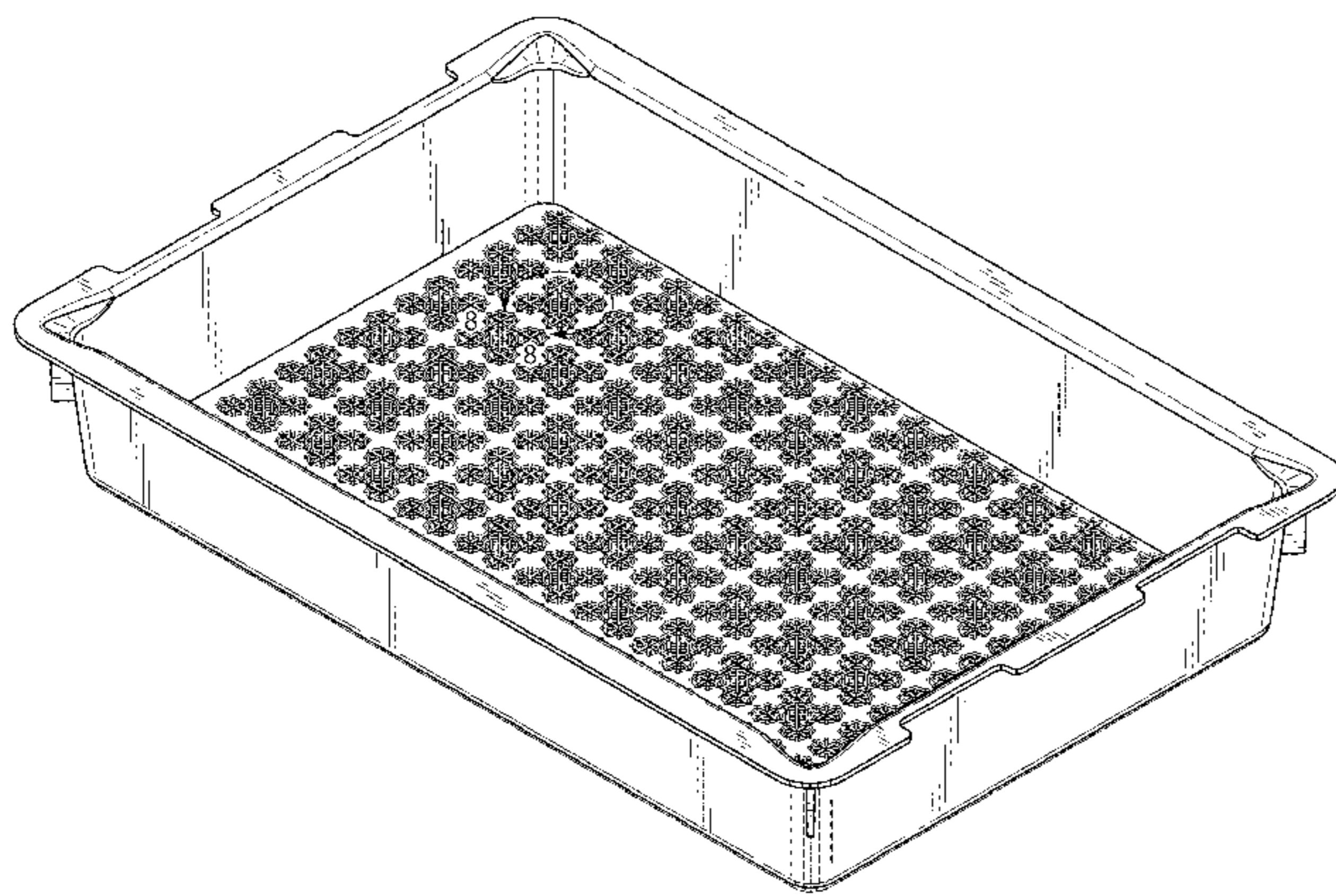

(58) **Field of Classification Search**

CPC . A61L 2/00; A61L 2/0011; A61L 2/06; A61L 2/10; A61L 2/26; A61M 1/3693; A61M 25/002; B01F 11/0022; B01F 11/0266; B01J 19/0046; B01L 3/0275; B01L 3/50; B01L 3/52; B01L 3/502; B01L 3/5021; B01L 35/5025; B01L 3/502715; B01L 3/505; B01L 3/508; B01L 3/5023; B01L 3/50255; B01L 3/502761; B01L 3/502707; B01L 3/5082; B01L 3/50825; B01L 3/5085; B01L 3/50851; B01L 3/50855; B01L 3/50853; B01L 3/523; B01L 3/527; B01L 3/545; B01L 7/00; B01L 7/52; B01L 9/06; B01L 9/52; B05C 3/109; B65D 81/3484; G01N 21/03; G01N 21/07; G01N 27/00; G01N 27/44756; G01N 27/447; G01N 27/44704; G01N 27/4473; G01N 27/4475; G01N 27/61; G01N 27/84; G01N 33/08524; G01N 33/383; G01N 33/5032; G01N 33/54326; G01N 33/543; G01N 33/5431; G01N 33/5436; G01N 33/558; G01N 35/00029; G01N 35/02; G01N 35/025; G01N 35/026; G01N 35/04; G01N 35/1002; G03C 8/34

See application file for complete search history.

(56) **References Cited**

U.S. PATENT DOCUMENTS

4,822,742 A * 4/1989 Challberg B01L 3/508
422/940

4,830,725 A * 5/1989 Berninger G01N 27/44704
204/620
D303,012 S * 8/1989 Flesher D24/233
D315,951 S * 4/1991 Berninger D24/233
5,013,420 A * 5/1991 Schuette G01N 27/4473
204/614
5,085,758 A * 2/1992 Guadagno G01N 27/44704
204/616
5,514,255 A * 5/1996 Gautsch G01N 27/44704
204/466
5,641,065 A 6/1997 Owens et al.
6,027,695 A 2/2000 Oldenburg et al.
6,036,021 A * 3/2000 Moi G01N 27/44704
204/456
6,800,491 B2 10/2004 Ringleben et al.
7,118,713 B2 * 10/2006 Brock B01L 9/52
422/566
7,217,397 B1 * 5/2007 Astle B01L 3/50855
117/206
D559,398 S 1/2008 Maliakal
D587,110 S 2/2009 Kronshage et al.
D599,031 S 8/2009 Kelly
7,811,522 B2 10/2010 Mathus et al.
D629,119 S * 12/2010 Motadel D24/224
D669,596 S 10/2012 Motadel
2011/0177592 A1 * 7/2011 Faustman G01N 33/54326
435/325
2013/0017132 A1 * 1/2013 Schryver B01L 3/508
422/547
2017/0028400 A1 * 2/2017 Gaynor B01L 3/52
2017/0045542 A1 * 2/2017 Lapham G01N 35/026
2017/0157611 A1 * 6/2017 Weber B01L 3/502707
2017/0246630 A1 * 8/2017 Gaynor B01L 3/50851

* cited by examiner

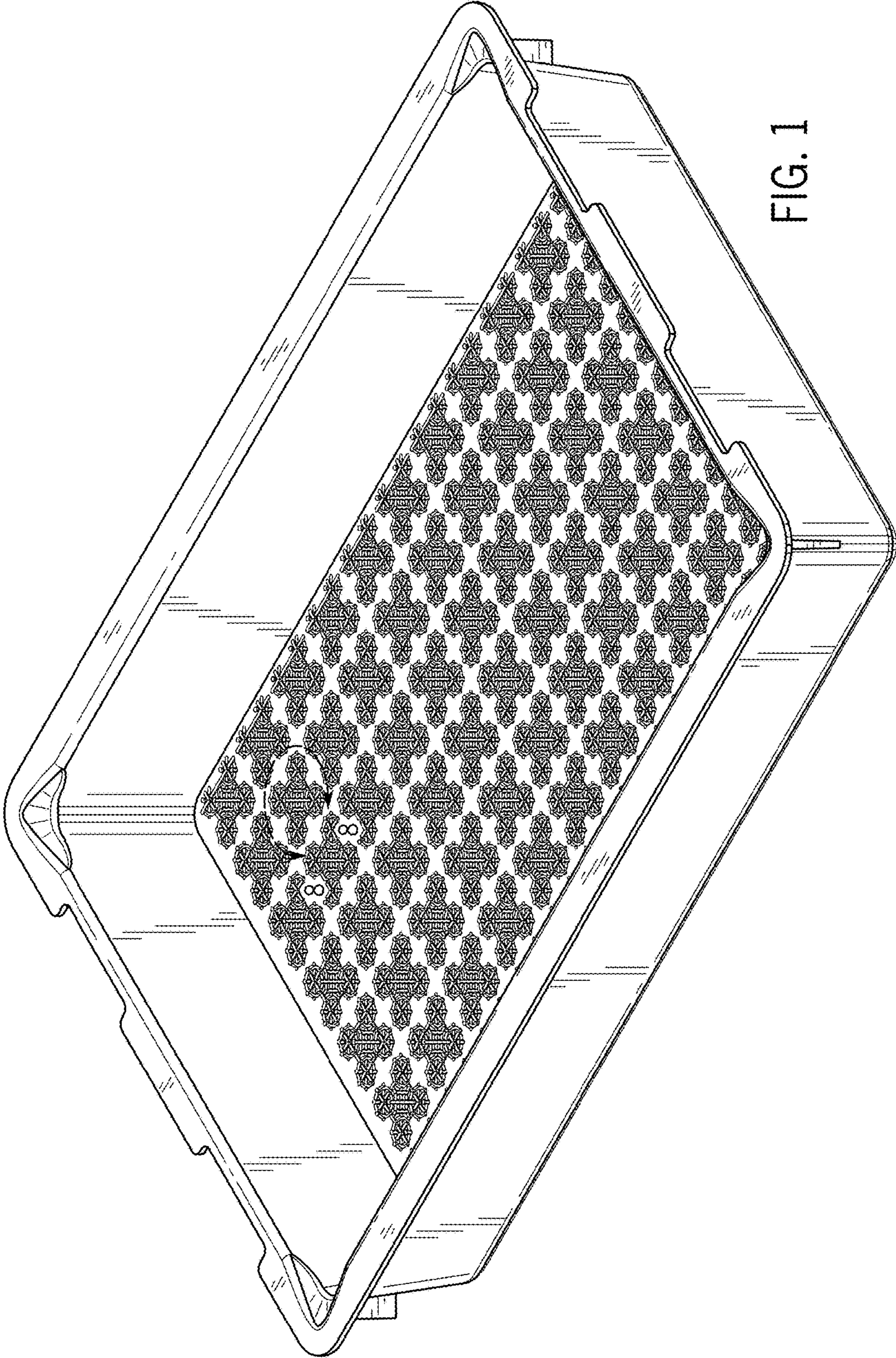
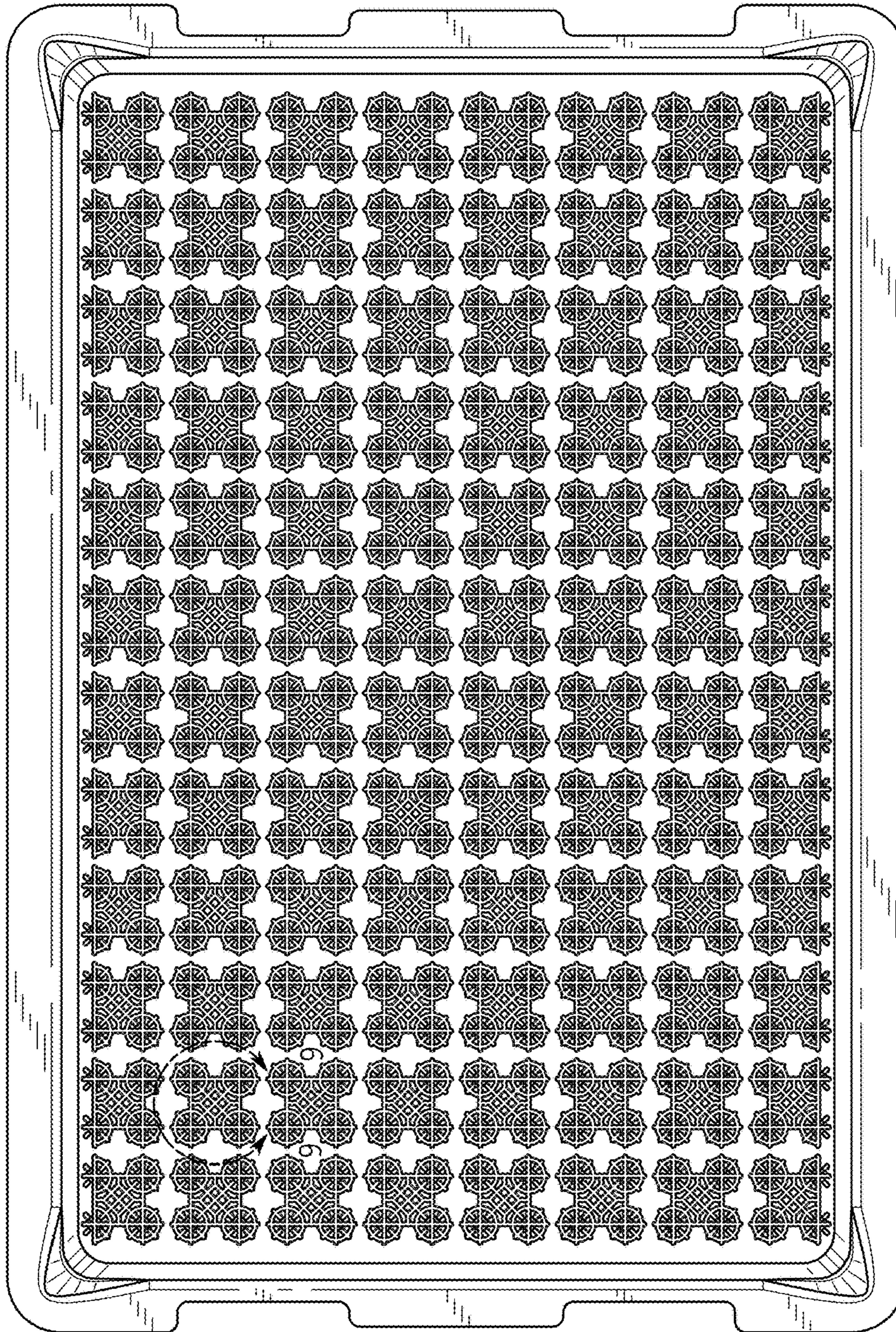

FIG. 1

FIG. 2



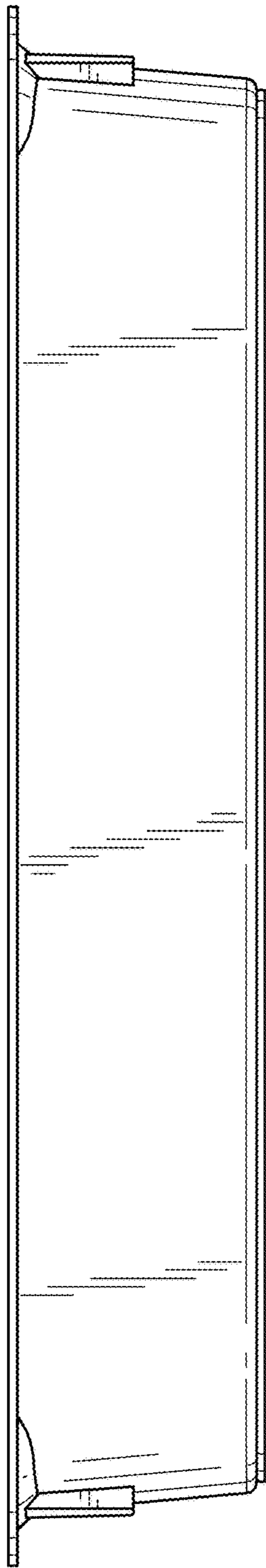

FIG. 3

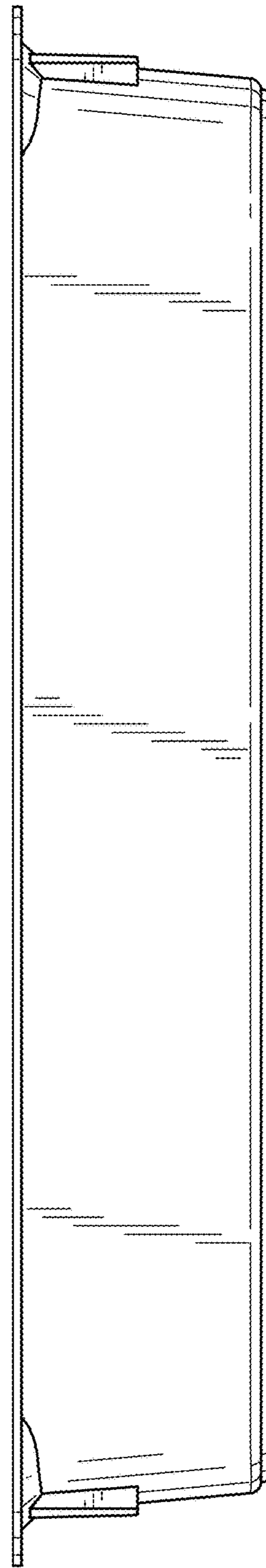

FIG. 4

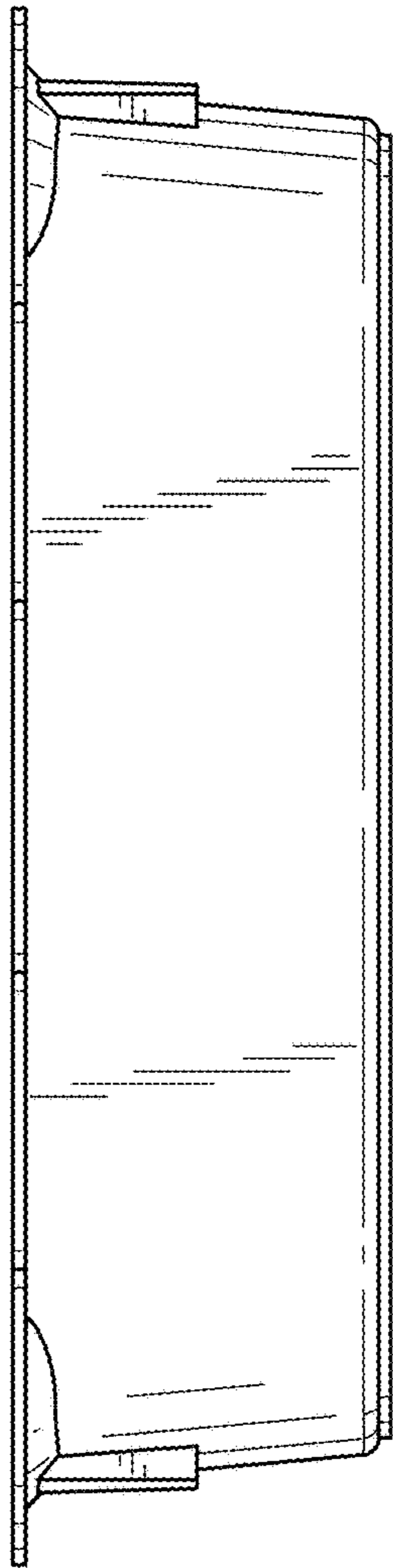

FIG. 5

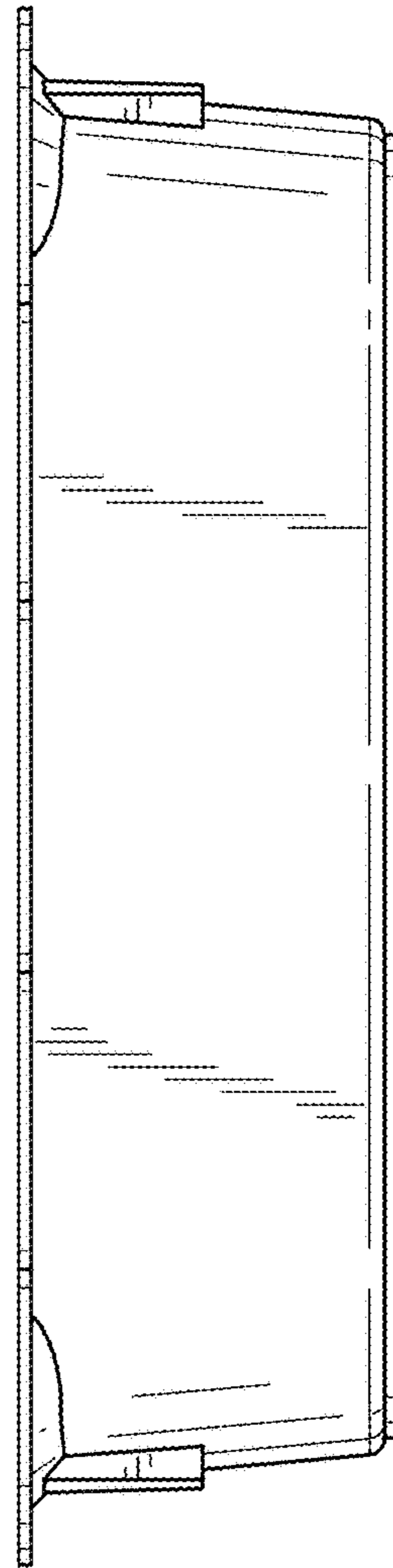
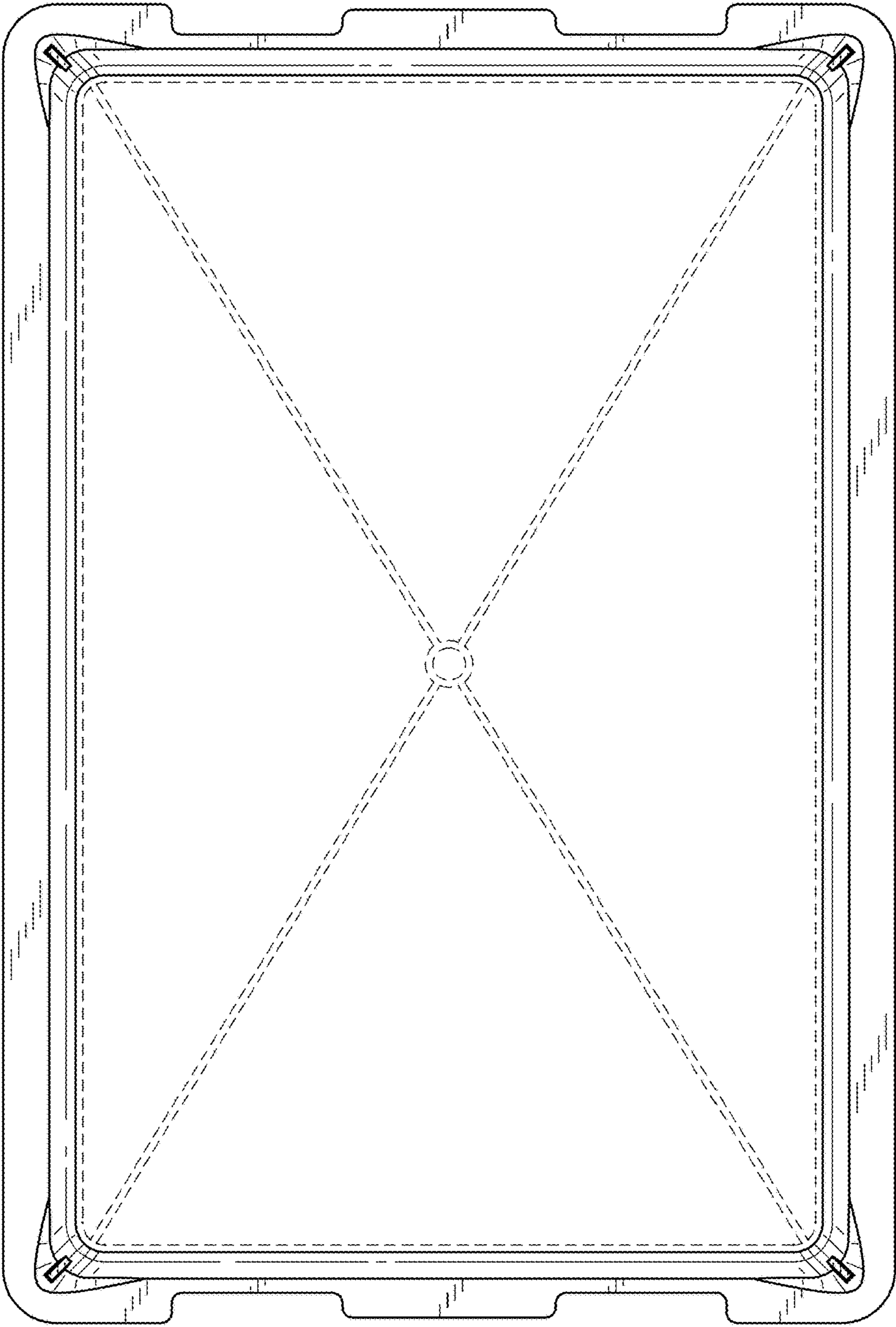

FIG. 6

FIG. 7



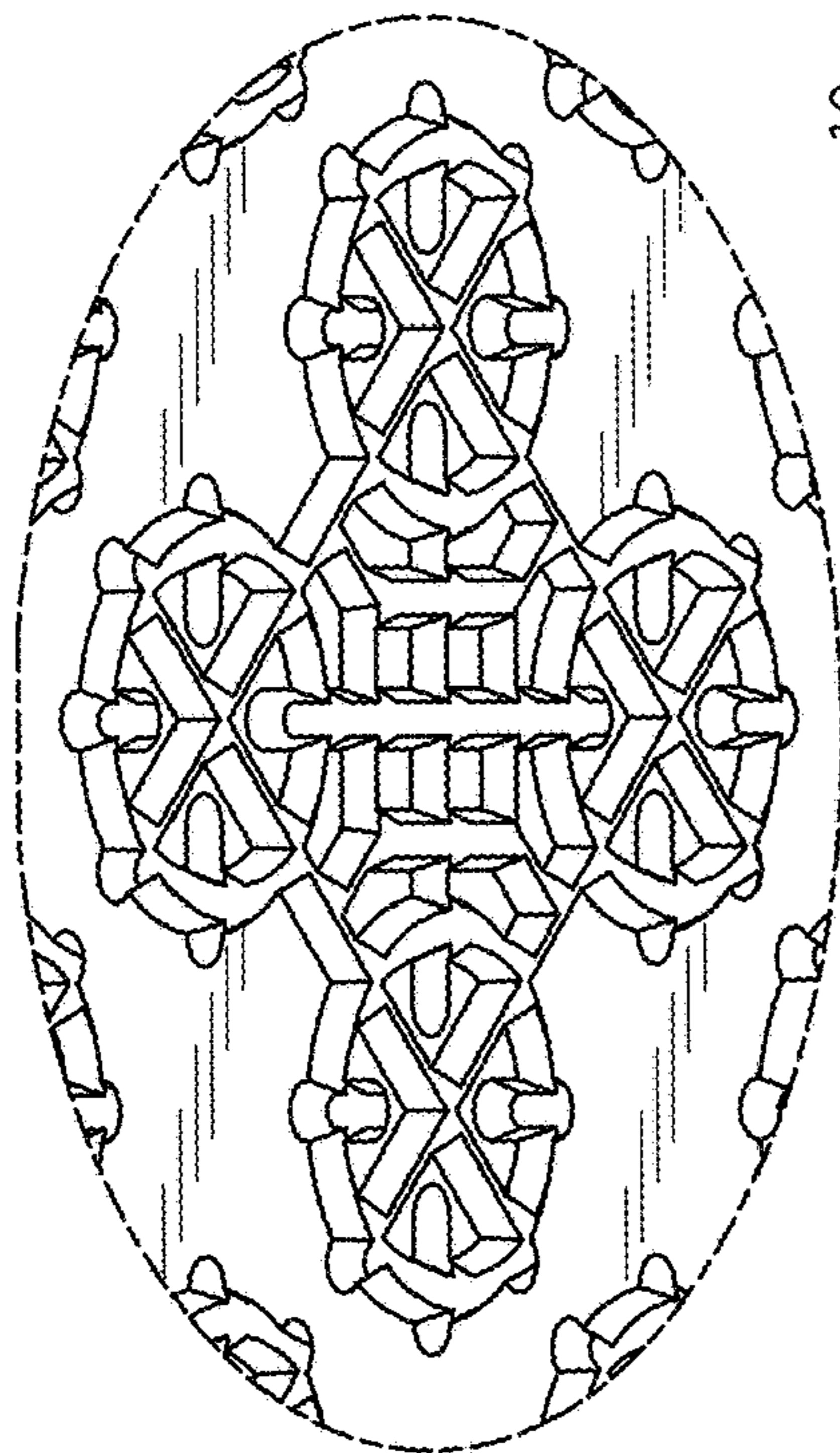

FIG. 8

FIG. 9

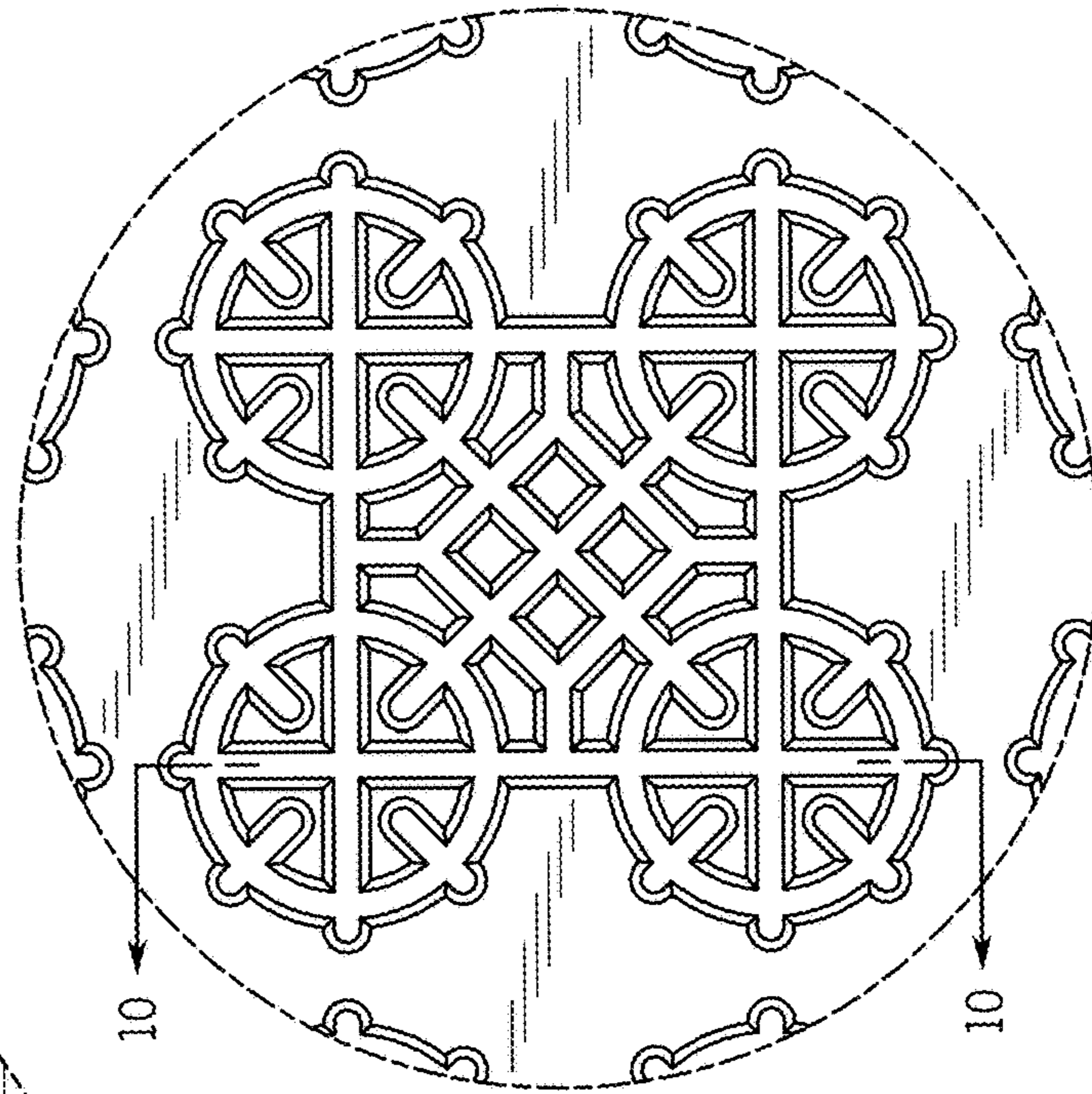

FIG. 10



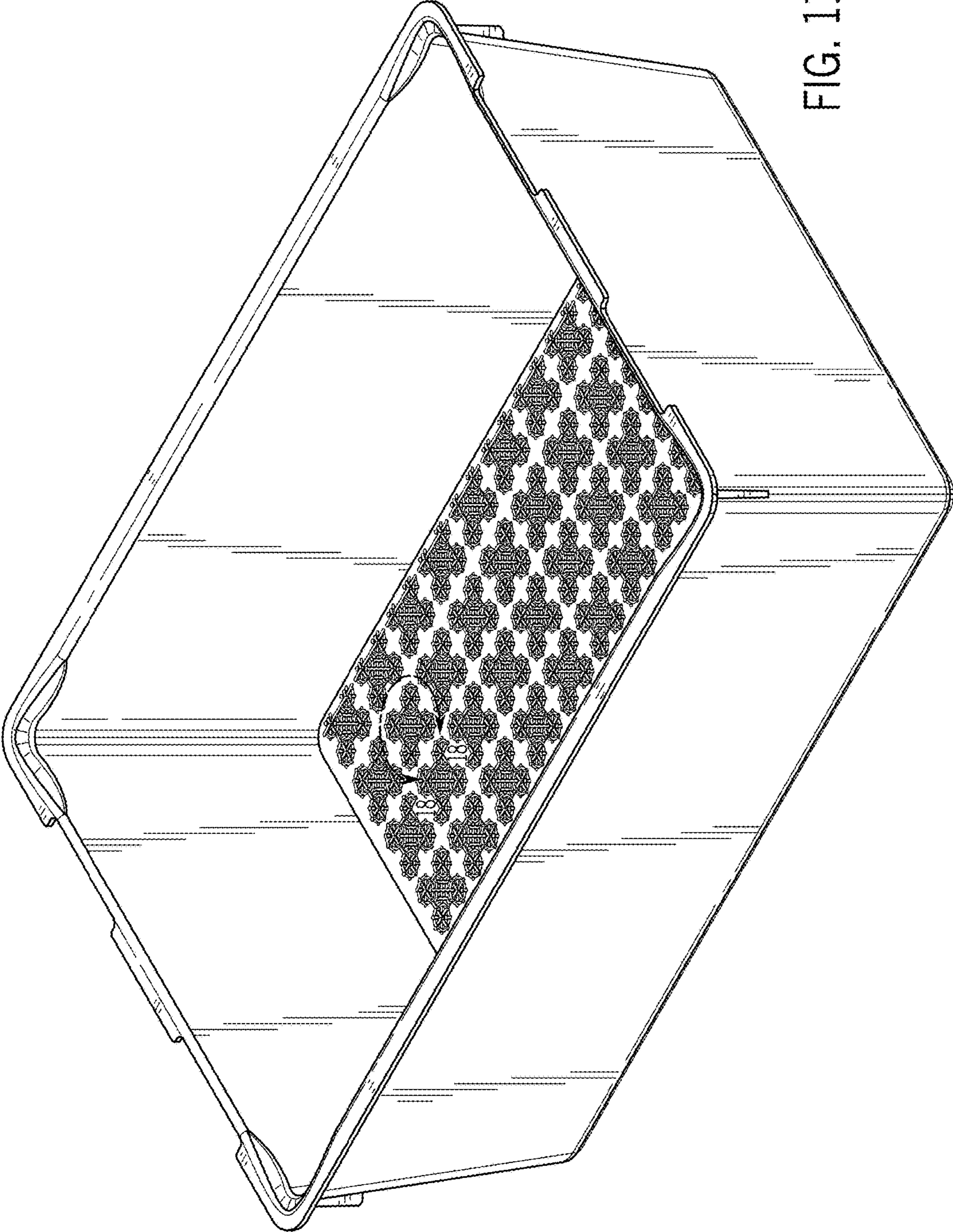

FIG. 11

FIG. 12

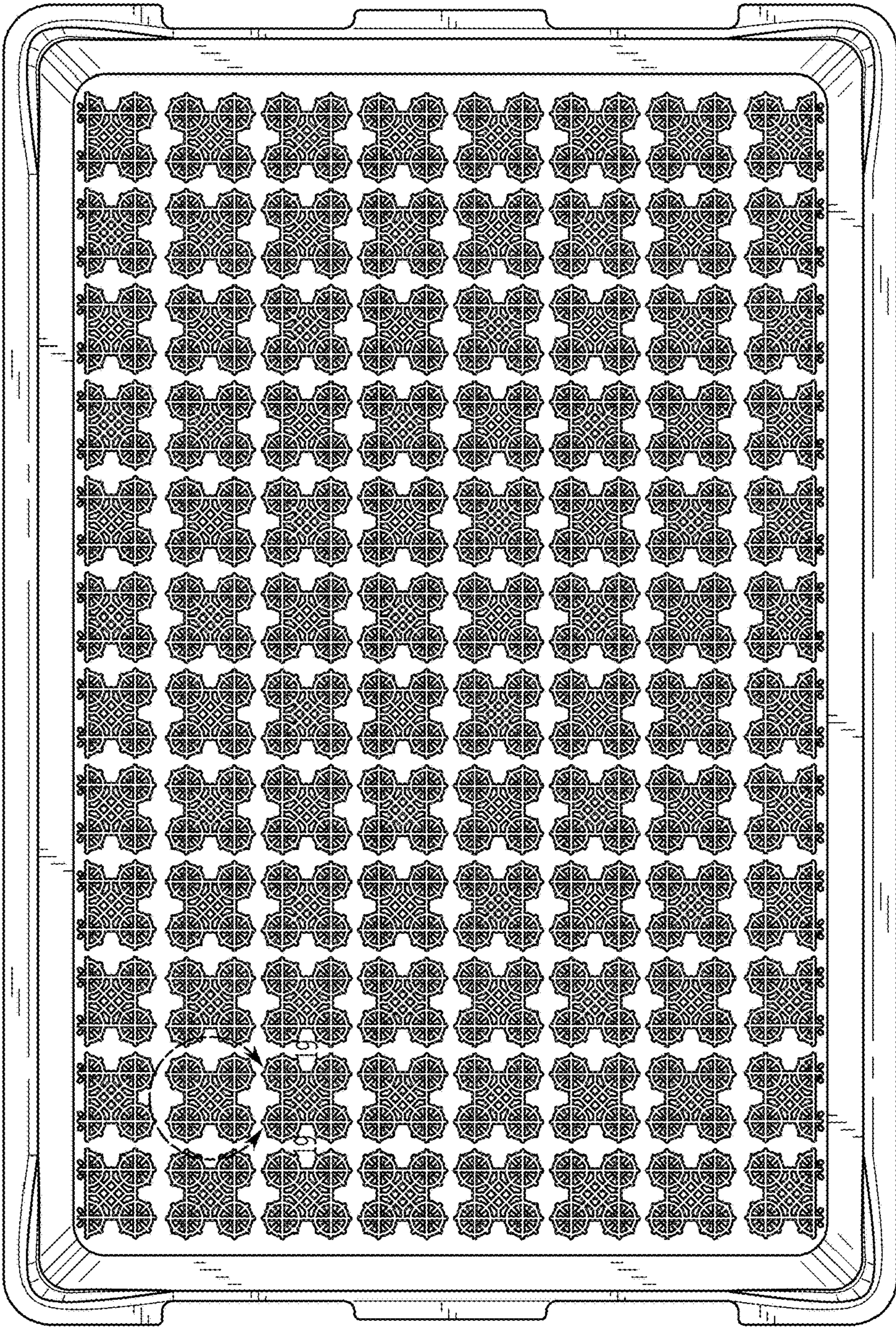

FIG. 13

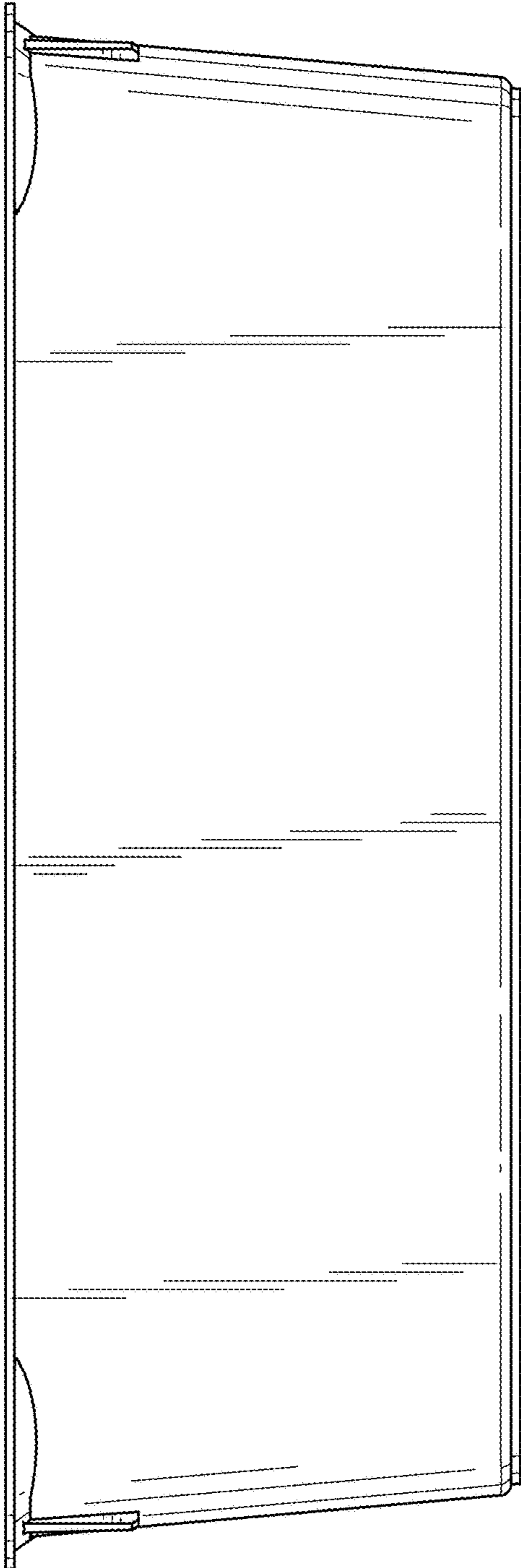

FIG. 14

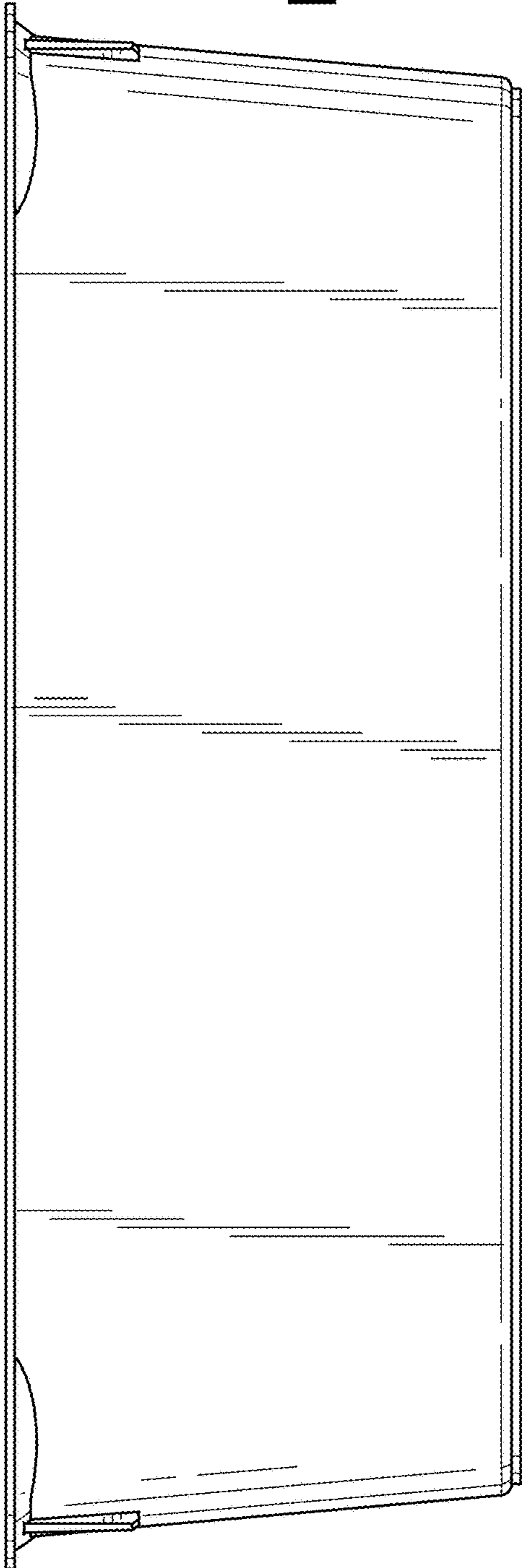

FIG. 15

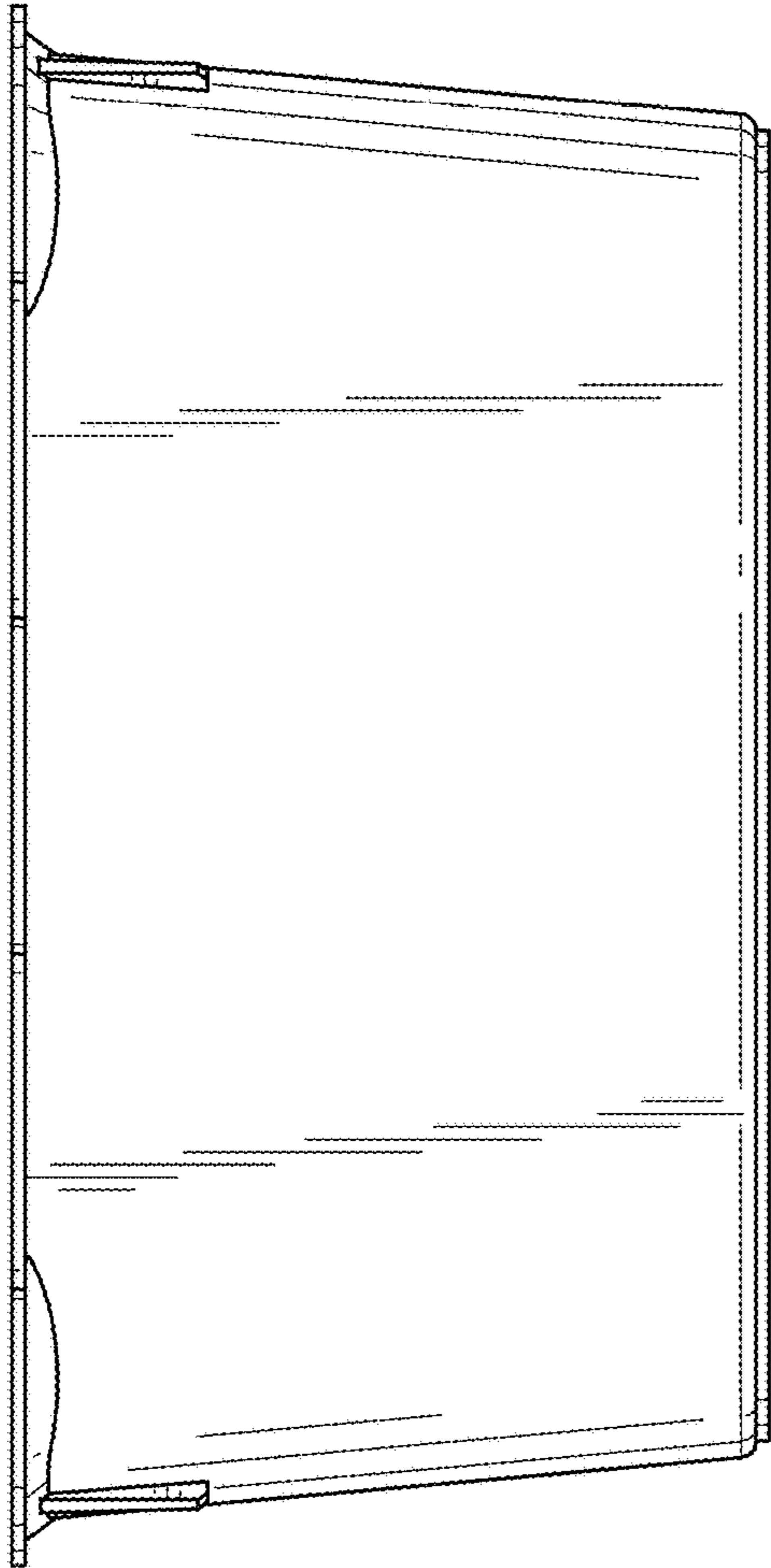

FIG. 16

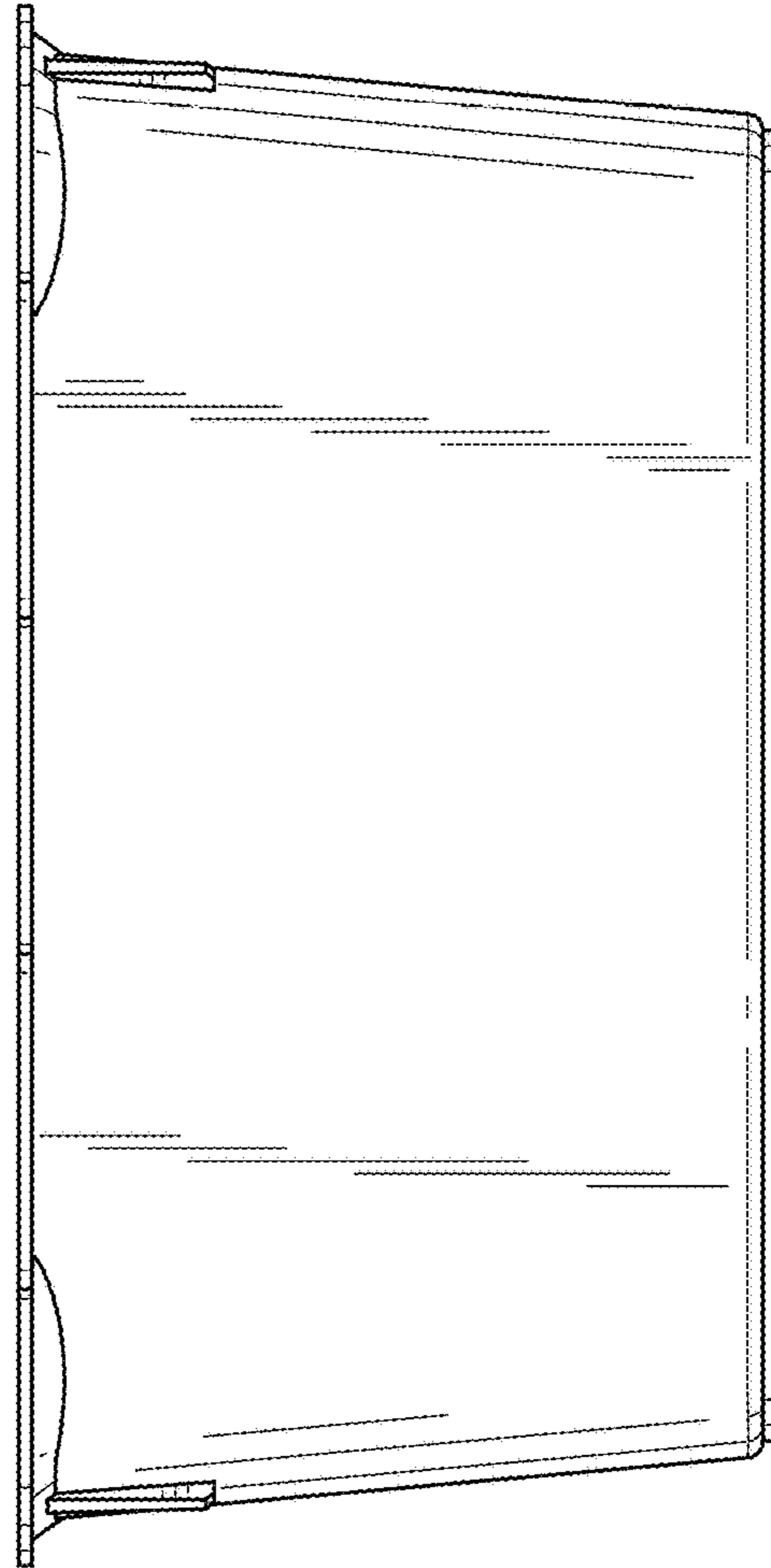
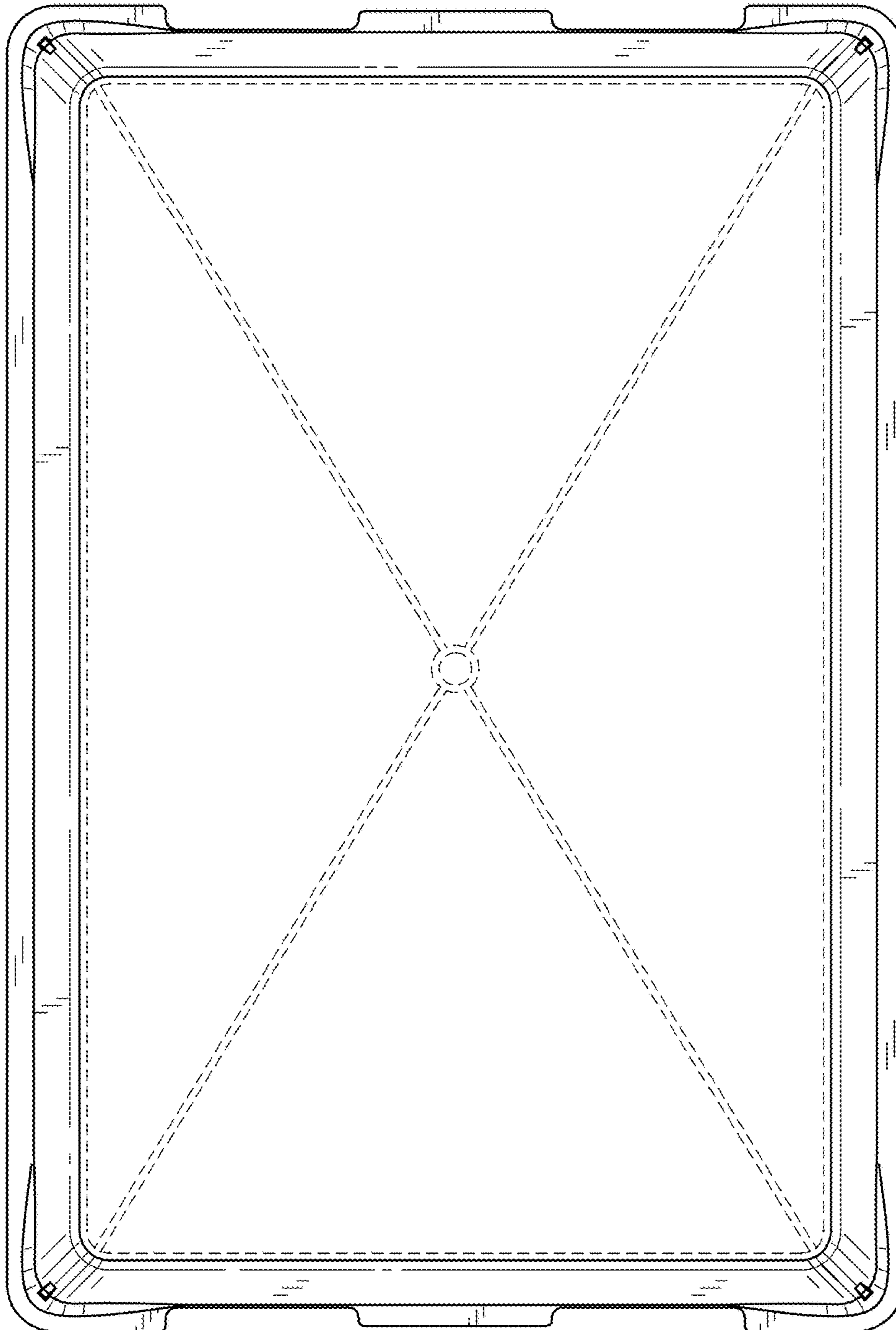

FIG. 17



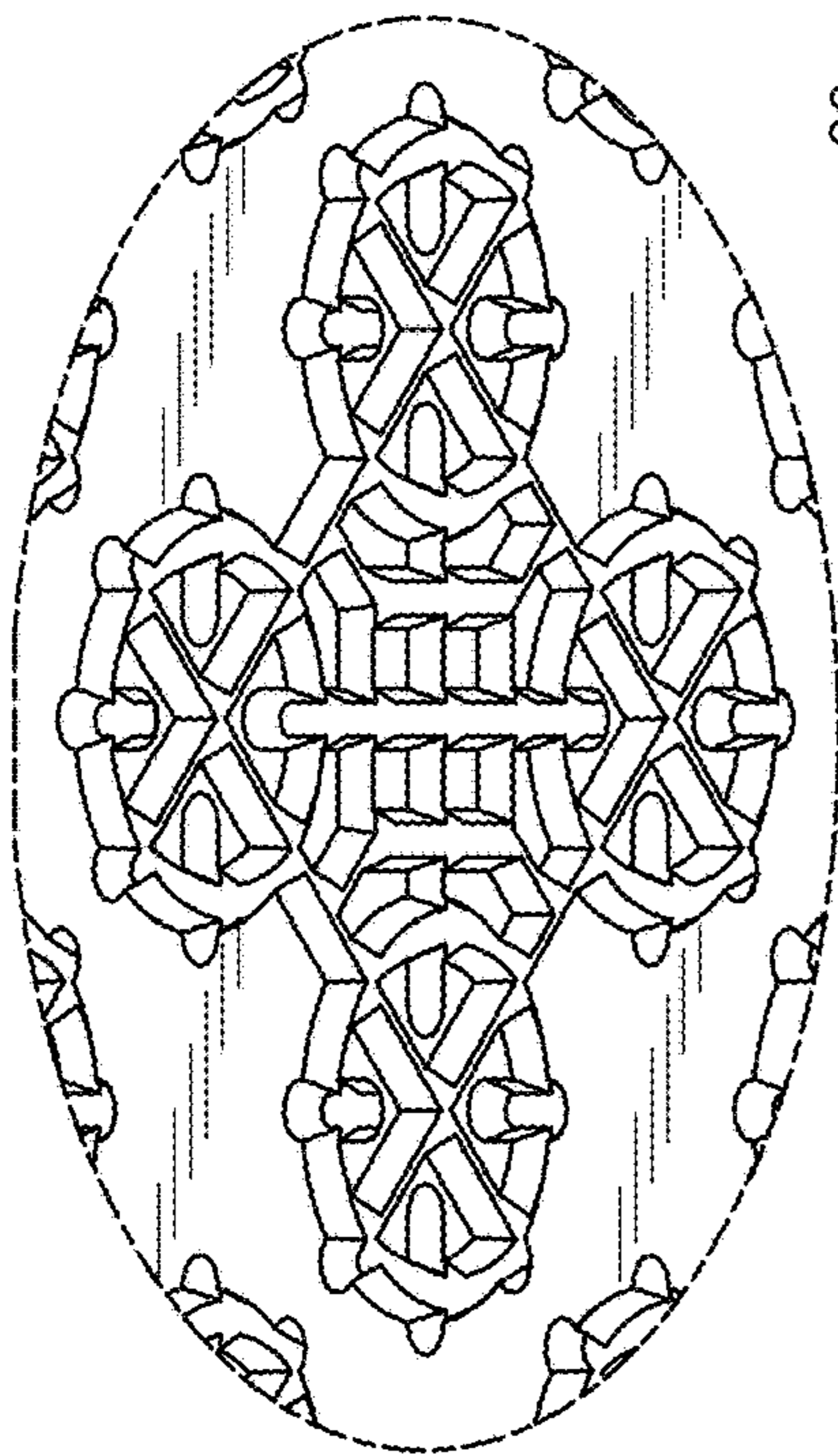

FIG. 18

FIG. 19

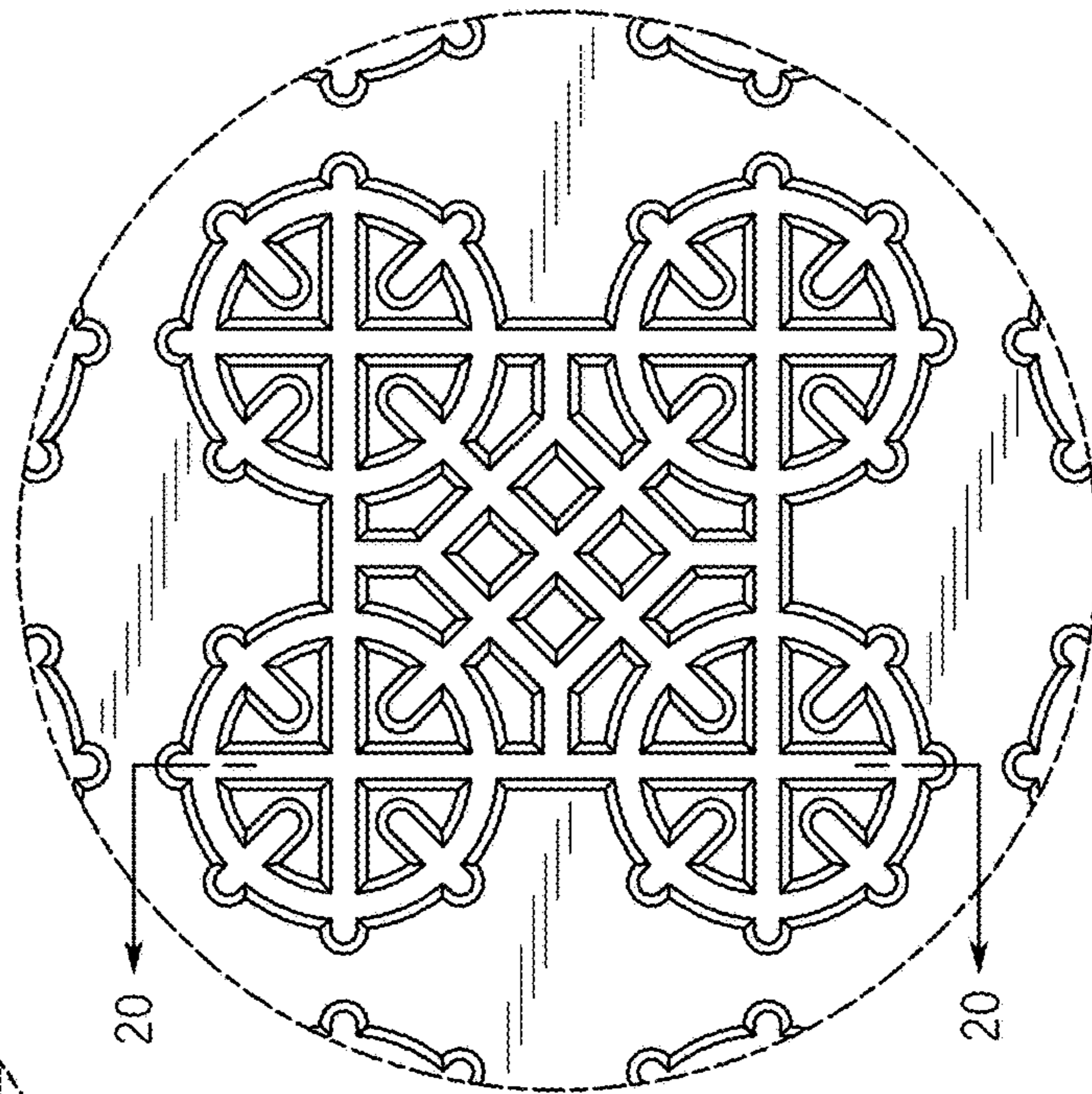

FIG. 20

