



US00D824481S

(12) **United States Design Patent** (10) **Patent No.:** **US D824,481 S**
Geissele (45) **Date of Patent:** **** Jul. 31, 2018**

(54) **FIREARM MOUNT**

(56) **References Cited**

(71) Applicant: **WHG Properties, LLC**, North Wales, PA (US)

U.S. PATENT DOCUMENTS

(72) Inventor: **William H. Geissele**, Lower Gwynedd, PA (US)

D127,735 S	6/1941	Dreyfuss
2,671,287 A	3/1954	Hayes
D187,412 S	3/1960	Young
3,091,878 A	6/1963	Savioli
3,269,045 A	8/1966	McGaughey
D253,513 S	11/1979	Bertani
D269,409 S	6/1983	Ferdinand et al.

(73) Assignee: **WHG Properties, LLC**, North Wales, PA (US)

(Continued)

(**) Term: **15 Years**

OTHER PUBLICATIONS

(21) Appl. No.: **29/635,307**

Midwest Industries AK Railed Side Scope Mount Aluminum Black MI-AKSM, CheaperThanDirt.com, [online], [site visited May 16, 2018]. <URL: <https://www.cheaperthandirt.com/product/nmidwest-industries-ak-railed-side-scope-mount-aluminum-black-mi-aksm-816537012030.do>> (Year: 2018).*

(22) Filed: **Jan. 30, 2018**

(Continued)

Related U.S. Application Data

(62) Division of application No. 29/584,526, filed on Nov. 15, 2016.

Primary Examiner — T. Chase Nelson

(51) **LOC (11) Cl.** **22-01**

Assistant Examiner — Jonathan J Han

(52) **U.S. Cl.**

(74) *Attorney, Agent, or Firm* — Fox Rothschild LLP

USPC **D22/110**

(58) **Field of Classification Search**

(57) **CLAIM**

The ornamental design for a firearm mount, as shown and described.

USPC D22/108–110; D16/130, 132–134, 330; 89/111–113; 359/399, 823; 42/104, 105, 42/111–113, 116, 120, 124–126, 42/127–129, 141–148, 133–140; 33/227, 33/229

DESCRIPTION

CPC F41G 1/00; F41G 1/01; F41G 1/02; F41G 1/06; F41G 1/065; F41G 1/08; F41G 1/10; F41G 1/12; F41G 1/14; F41G 1/30; F41G 1/32; F41G 1/38; F41G 1/40; F41G 1/42; F41G 1/44; F41G 1/46; F41G 1/383; F41G 1/387; F41G 1/393; F41G 3/00; F41G 3/005; F41G 3/02; F41G 3/04; F41G 3/06; F41G 3/14; F41G 11/001; F41G 11/002; F41G 11/003; F41G 11/004; F41G 11/005

FIG. 1 is a top, front, left side perspective view of a firearm mount according to the present disclosure.

FIG. 2 is a front view of the firearm mount of FIG. 1.

FIG. 3 is a rear view of the firearm mount of FIG. 1.

FIG. 4 is a right side view of the firearm mount of FIG. 1.

FIG. 5 is a left side view of the firearm mount of FIG. 1.

FIG. 6 is a top view of the firearm mount of FIG. 1; and,

FIG. 7 is a bottom view of the firearm mount of FIG. 1.

The broken lines in the Figures are used to illustrate unclaimed parts of the invention and form no part of the claimed design.

See application file for complete search history.

1 Claim, 6 Drawing Sheets

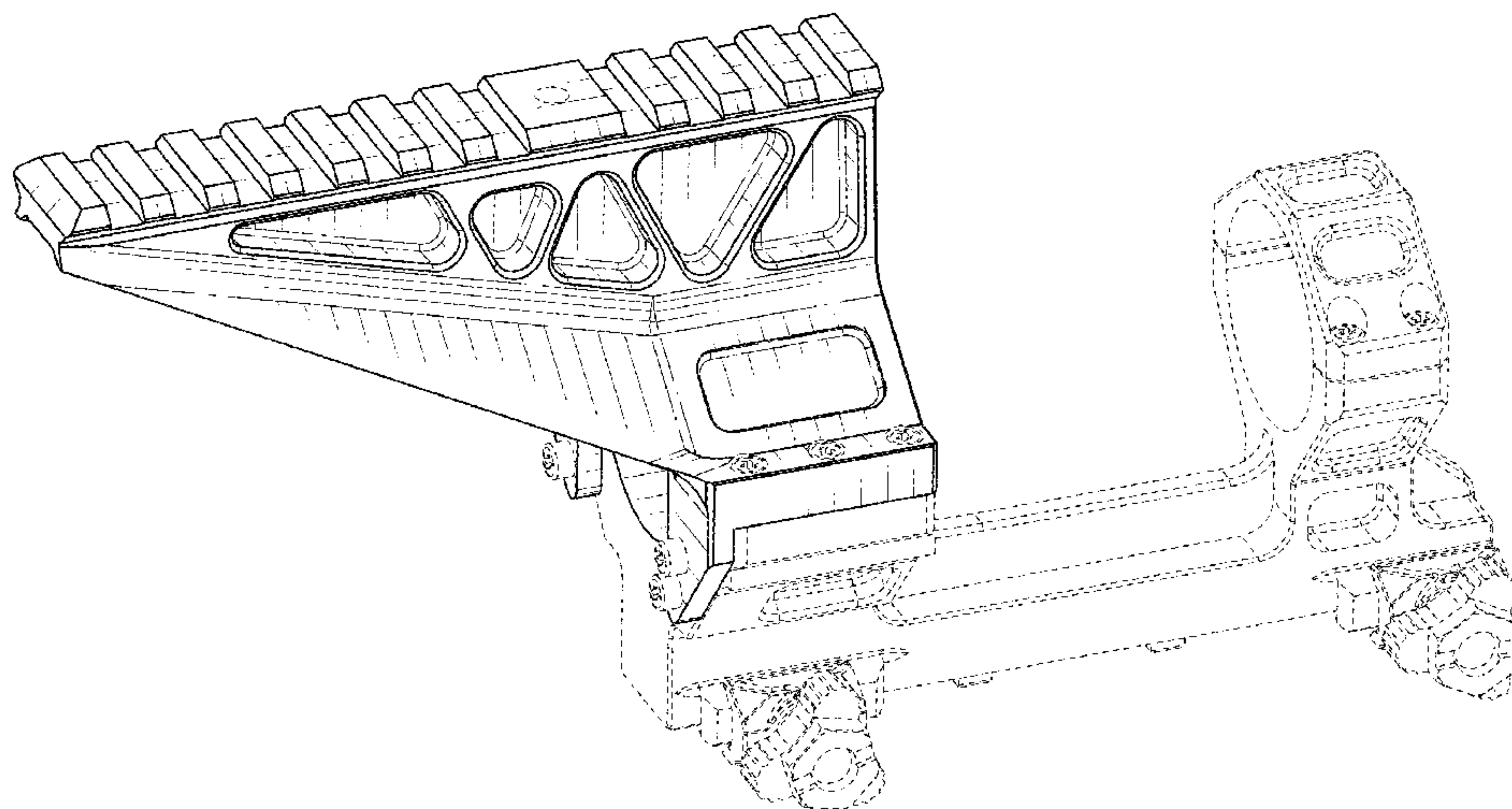

(56)

References Cited

U.S. PATENT DOCUMENTS

D276,838 S 12/1984 Hill et al.
 D291,470 S 8/1987 Bechtel
 4,709,617 A 12/1987 Anderson
 D318,313 S 7/1991 Bechtel
 D318,708 S * 7/1991 Bechtel D22/110
 5,417,002 A 5/1995 Guerra
 D367,312 S 2/1996 Martel
 D409,156 S 5/1999 Taylor et al.
 D410,061 S 5/1999 Emerson
 5,941,489 A * 8/1999 Fanelli F41G 1/16
 248/298.1
 D434,475 S 11/2000 Meda
 D435,885 S * 1/2001 Wallace D22/100
 D462,111 S 8/2002 Turnau, III et al.
 D463,246 S 9/2002 Becker
 D464,249 S 10/2002 Laabs et al.
 D467,789 S 12/2002 Laabs et al.
 D486,878 S * 2/2004 Selvaggio F41G 11/003
 D22/110
 D493,348 S 7/2004 Bertani
 D508,021 S 8/2005 Wirth
 D511,365 S 11/2005 Ding
 D513,056 S 12/2005 Ding
 D513,298 S 12/2005 Ding
 D513,299 S 12/2005 Ding
 D513,633 S 1/2006 Ding
 D520,949 S 5/2006 Wirth
 D533,618 S * 12/2006 Swan D22/110
 D537,901 S * 3/2007 Elkaim D22/109
 D537,902 S * 3/2007 Elkaim D22/109
 D539,632 S 4/2007 Ma
 D542,880 S * 5/2007 Cheng D22/110
 D543,605 S * 5/2007 Cheng D22/110
 D548,811 S * 8/2007 Swan D22/109
 D554,730 S 11/2007 Coggins
 D555,750 S 11/2007 Cheng
 D555,751 S 11/2007 Cheng
 D559,775 S 1/2008 Liukkula et al.
 D575,619 S 8/2008 Bertani
 D577,495 S 9/2008 Borovicka et al.
 7,481,016 B2 1/2009 Gonzalez
 D594,085 S 6/2009 Moody
 D607,959 S 1/2010 Moody
 D609,550 S 2/2010 Wan et al.
 D632,753 S 2/2011 Leighton
 7,900,390 B2 3/2011 Moody et al.
 D644,085 S 8/2011 Jungen
 D654,134 S * 2/2012 Edge D22/108
 D664,232 S * 7/2012 Storch D22/108
 D668,761 S 10/2012 Schad
 D672,840 S * 12/2012 Neufeld D22/108
 D673,239 S 12/2012 Cheng
 8,522,469 B2 * 9/2013 Baker F41G 11/003
 42/124
 8,528,140 B1 9/2013 Phillips
 D713,921 S 9/2014 Williams
 D715,393 S 10/2014 Williams
 D718,832 S 12/2014 Huang
 9,015,982 B1 * 4/2015 Powers F41G 1/44
 42/119
 D732,628 S * 6/2015 Cheng D22/108
 D738,986 S 9/2015 Anderson
 D739,912 S * 9/2015 Norberg D22/108
 D741,442 S 10/2015 Wilson
 D761,929 S * 7/2016 Hormann D22/108
 D762,098 S 7/2016 Bertani
 D762,439 S 8/2016 Bertani
 D768,257 S 10/2016 Boyd
 9,470,480 B2 10/2016 Kirchhoff
 D779,623 S 2/2017 Geissele
 D781,985 S 3/2017 McKillips
 D781,987 S 3/2017 Geissele
 D783,112 S 4/2017 Geissele
 D783,759 S 4/2017 Geissele
 D784,787 S 4/2017 Bertani

D787,007 S 5/2017 Maughn
 9,644,913 B2 5/2017 Dextraze
 9,733,034 B1 8/2017 Viani
 D798,129 S 9/2017 Bertani
 D802,077 S 11/2017 Geissele
 9,857,146 B1 * 1/2018 Shelton F41G 11/003
 D813,639 S 3/2018 Osanai
 D817,437 S * 5/2018 Hancosky D22/109
 2005/0183311 A1 8/2005 Diaz et al.
 2005/0229465 A1 10/2005 Dextraze
 2008/0005952 A1 1/2008 Sutherby
 2009/0038201 A1 * 2/2009 Cheng F41G 11/003
 42/127
 2011/0167696 A1 7/2011 Gangl
 2011/0197491 A1 * 8/2011 McCann F41G 1/033
 42/132
 2013/0008073 A1 * 1/2013 Clifton F41G 11/003
 42/125
 2013/0185985 A1 * 7/2013 Ballard F41G 1/00
 42/148
 2013/0312309 A1 11/2013 Rorick
 2014/0259854 A1 9/2014 Williams
 2015/0198397 A1 7/2015 Motley
 2016/0102946 A1 * 4/2016 Sharron F41G 11/003
 42/90
 2016/0102947 A1 4/2016 Visinski
 2016/0363416 A1 * 12/2016 Klotz F41C 27/00
 2017/0059280 A1 3/2017 Fravor

OTHER PUBLICATIONS

H&R1871 NEF Pardner Pump Shotgun Scope Base Rail Mount, TrinitySupply.com, [online], [site visited May 16, 2018]. <URL: <https://www.trinitysupply.com/H-R-1871-shotgun-saddle-mount-p/295.htm>> (Year: 2018).*

Install Badger Embedded Front Rail (EFR), ShortActionCustoms.com, by admin, Jan. 17, 2011, [online], [site visited May 16, 2018]. < URL: <http://shortactioncustoms.com/install-badger-embedded-front-frail-efr/>> (Year: 2011).*

TFB Review: Armageddon Tactical AK47 Hinged Side Rail Mount, TheFirearmBlog.com, Aug. 23, 2017, <http://www.thefirearmblog.com/blog/2017/08/23/tfb-review-armageddon-tactical-ak47-hinged-side-rail-mount>.

SKS See Thru Scout Scope Mount by Brass Stacker, MountPlus.com, http://www.mountplus.com/AR-15_Accessories/AR-15_Scope_Rings/151-TGR-SKS-SSM.html (2018).

Trinity Force 30mm Monolithic Quick-Detach Scope Mount w/Top Rail and 1-inch Inserts, DeltaTeamTactical.com, https://www.deltateamtactical.com/Trinity-Force-30mm-Monolithic-Quick-Detach-Scope-Mount-w/Top-Rail-and-1-inch-Inserts_p_4613.html (2018).

FAB Defense Glock Tactical Scope Mount, MidwayUSA.com, <https://www.midwayusa.com/product/1008970315/fab-defense-glock-tactical-scope-mount-all-railed-glock-models> (2018).

Mini 14 Tactical Metal Quad-rail Handguard, IFAtactical.com, <http://www.ifatactical.com/page/19264196> (2018).

Remington 870 Tactical Mount by Barska, Barska.com, <https://www.barska.com/remington-870-tactical-mount-rail-by-barska.html> (2018).

FM Tactical Scope Mount with 1" Rings and Picatinny Rails on Rings, JGsales.com, <http://www.jgsales.com/fm-tactical-scope-mount-with-1-rings-and-picatinny-rails-on-rings,-black,-fntml1.-p-3760.html> (2018).

LaRue Tactical Scope Mount QD LT745, LaRue.com, <https://www.larue.com/products/larue-tactical-scope-mount-qd-lt745/> (2018).

VTT Knobs with solid section, Eles-Ganter.com, [online], [site visited May 16, 2018]. <URL: <https://www.elesa-ganter.com/products/clamping-knobs/series/vtt>> (Year 2018).

Tekton 26756 10 pc Slotted and Phillips Screwdriver Set, Ebay.com, [online], [site visited May 16, 2018]. <URL: <https://www.ebay.com/itm/Tekton-26756-10-Pc-Slotted-and-Phillips-Screwdriver-Set-3-Sided-Handle-USA-Made-/222696470652>> (Year 2018).

Mount three-way Pivot Arm assembly extension + 2 knob screw bolt nut for Gopro HD, Ebay.com, [online], [site visited May 16,

(56)

References Cited

OTHER PUBLICATIONS

2018], <URL:https://www.ebay.com/itm/mount-three-way-Pivot-Arm-assembly-extension-2-knob (Year: 2018).

Krofel Magnetic Vehicle Air Vent Mount with Adjustable Knob. com, [online], [site visited May 16, 2018]. <URL:https://www.krofel.com/product/krofel-magnetic-car-air-vent-holder/> (Year 2018).

* cited by examiner

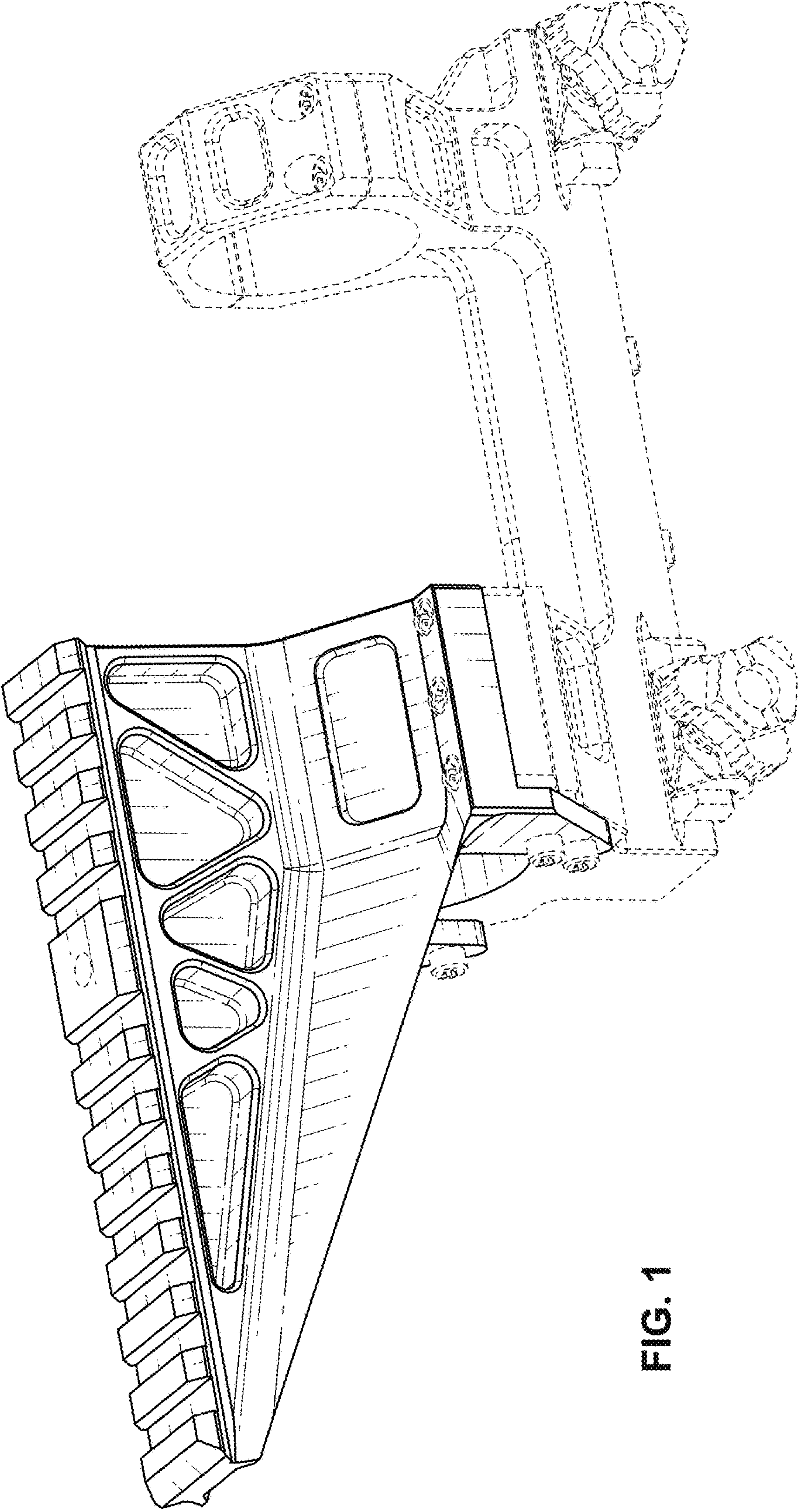

FIG. 1

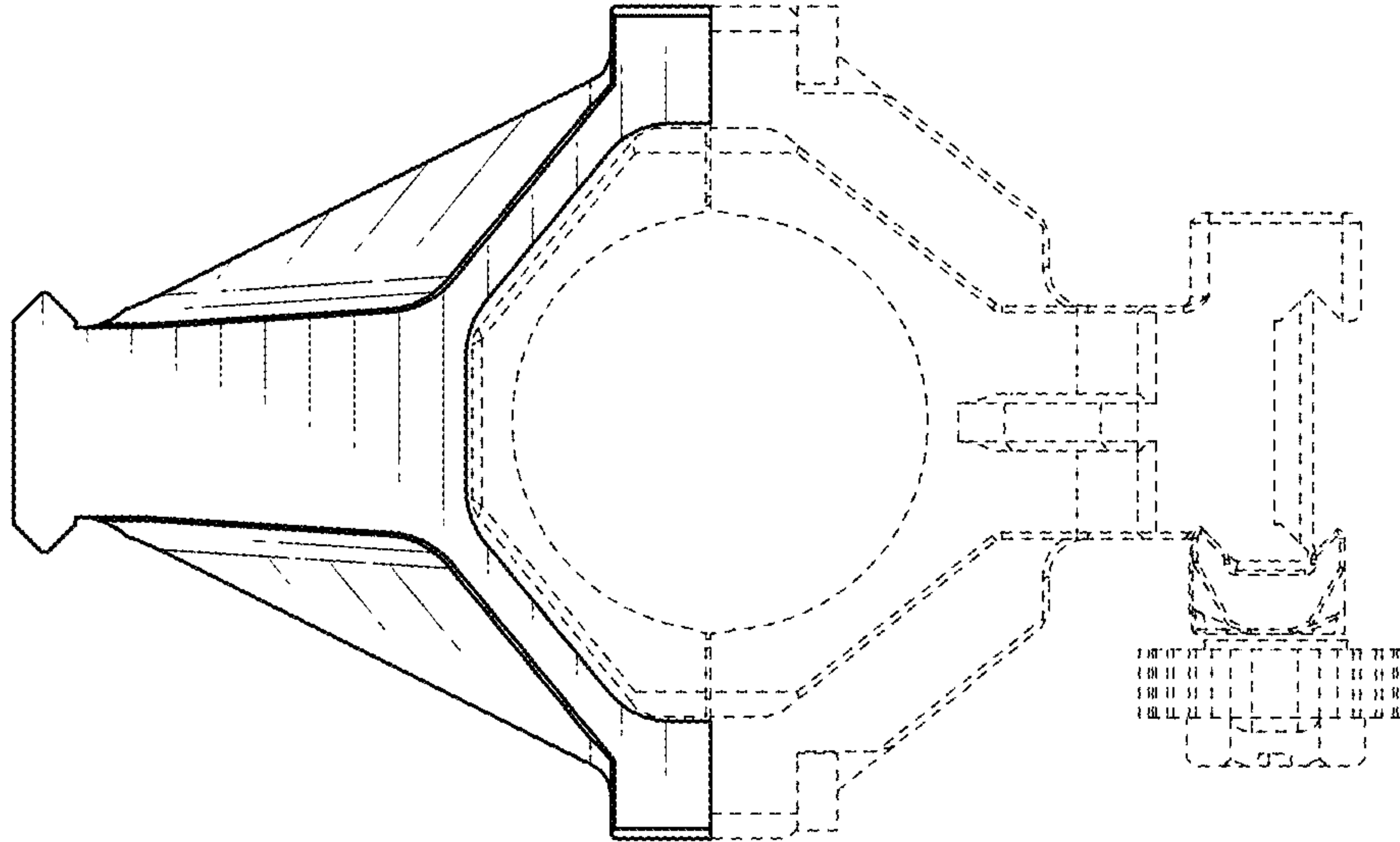

FIG. 3

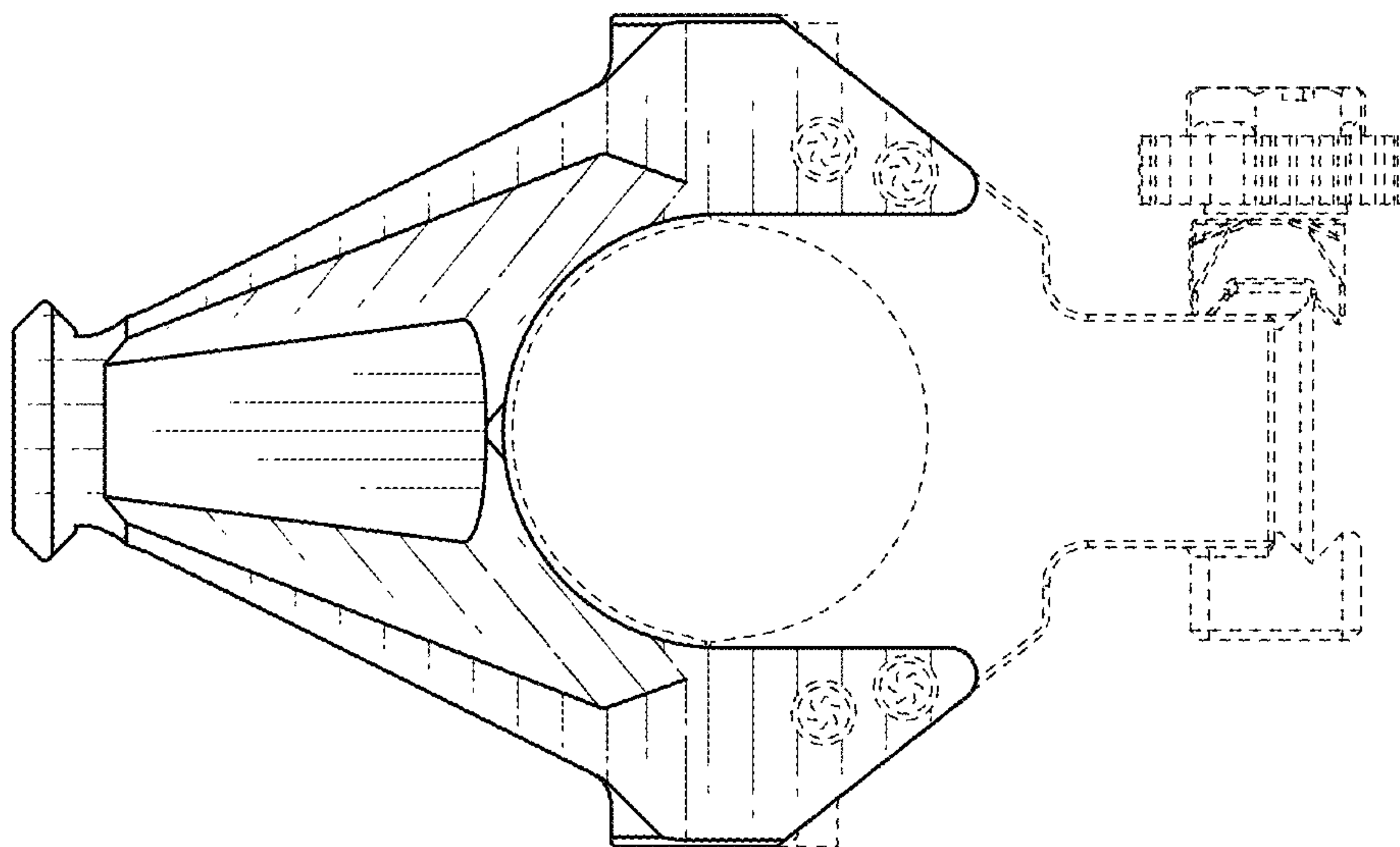

FIG. 2

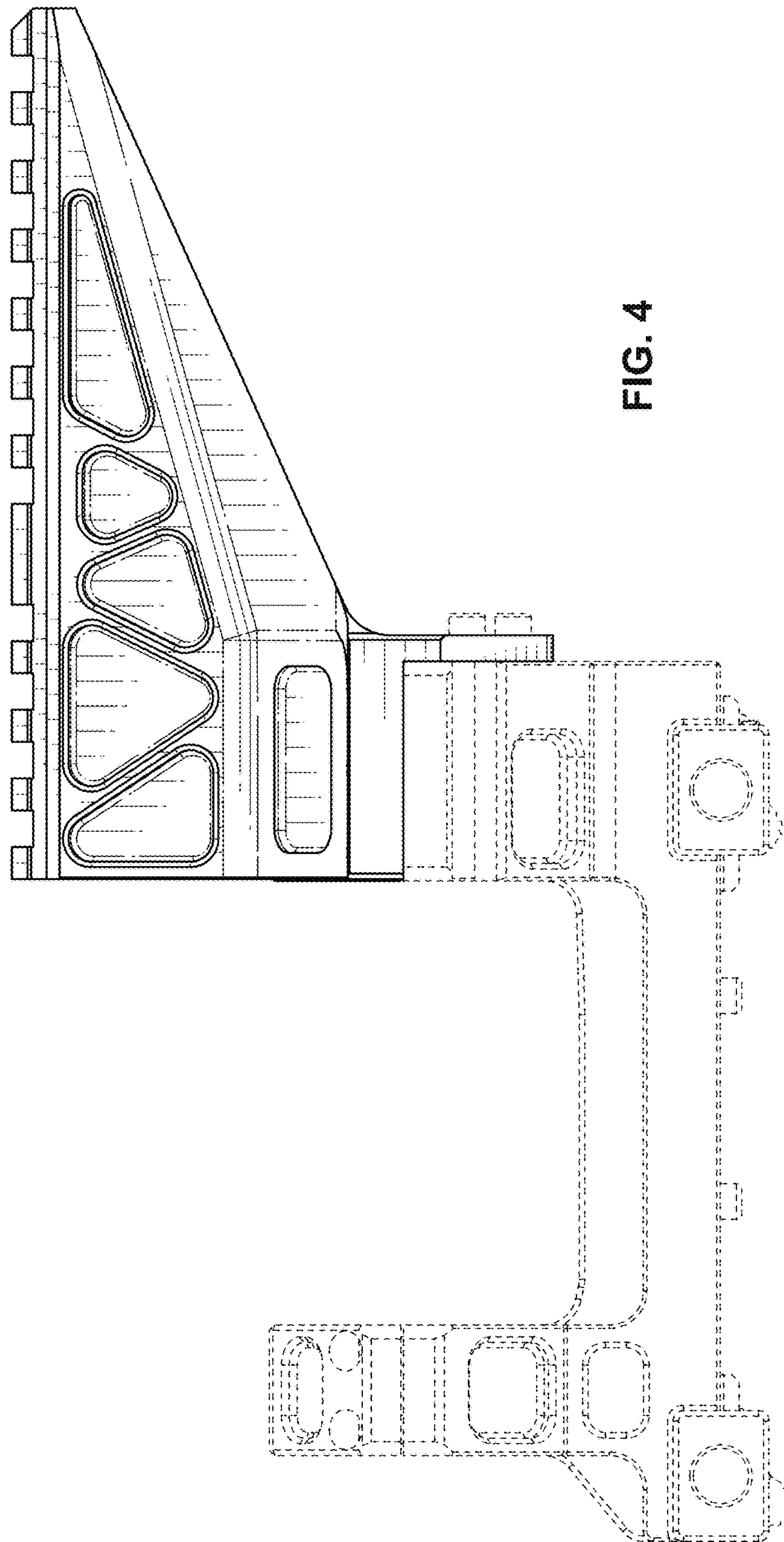

FIG. 4

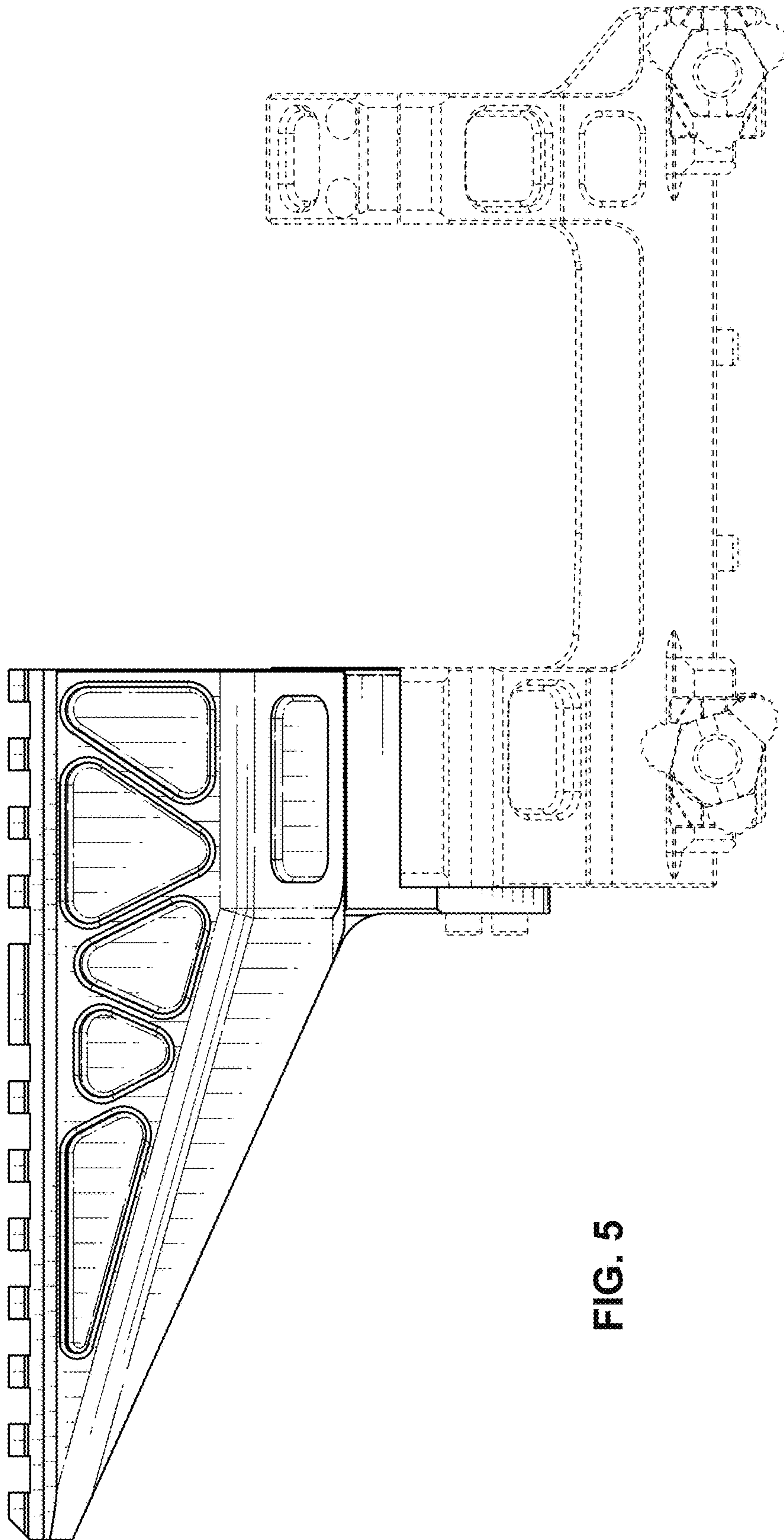

FIG. 5

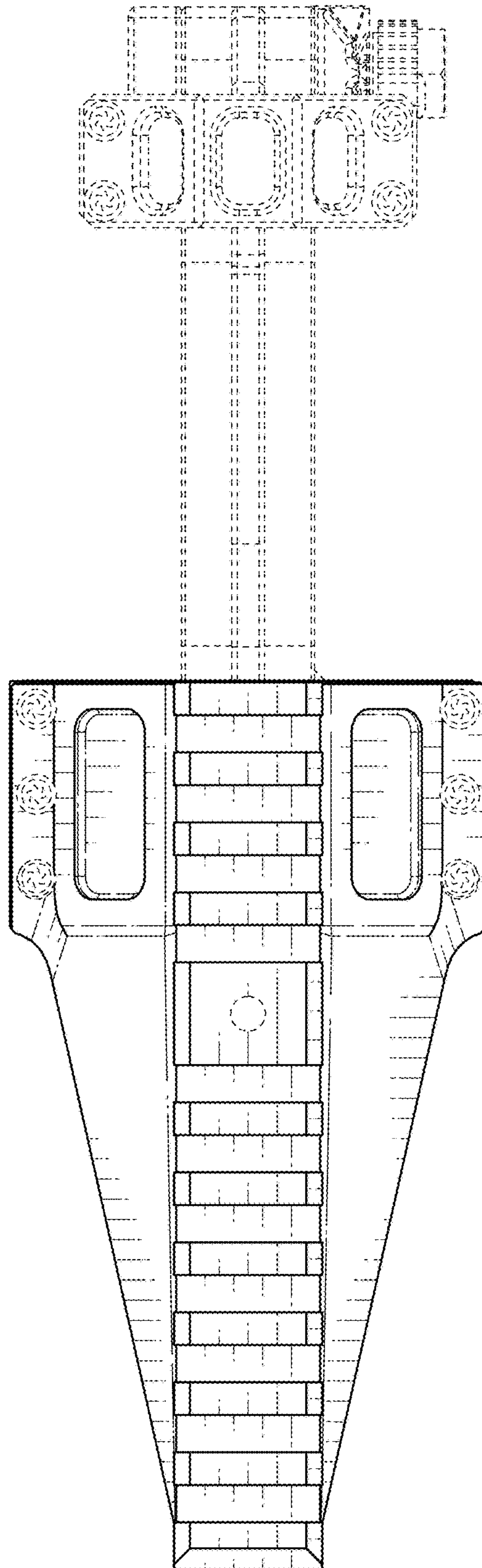

FIG. 6

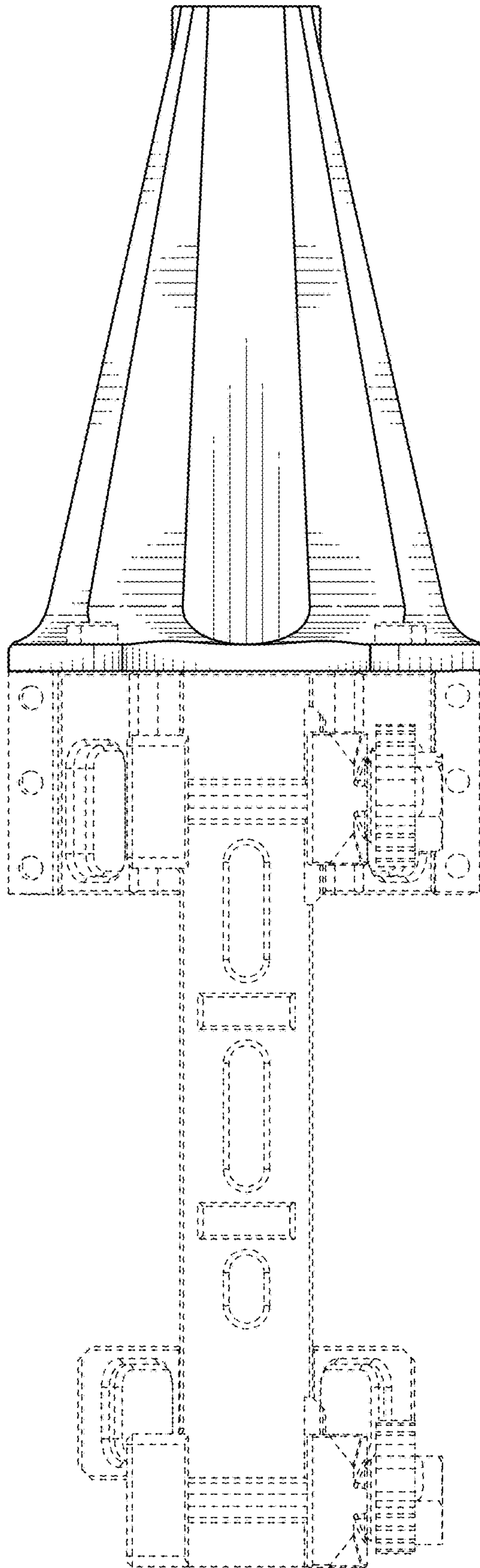

FIG. 7