



US00D824450S

(12) **United States Design Patent**  
**Samo**

(10) **Patent No.:** **US D824,450 S**  
(45) **Date of Patent:** **\*\* Jul. 31, 2018**

(54) **TEMPLE-HELD SUNGLASSES**

(71) Applicant: **Zuhair Samo**, Yuma, AZ (US)

(72) Inventor: **Zuhair Samo**, Yuma, AZ (US)

(\*\*) Term: **15 Years**

(21) Appl. No.: **29/570,777**

(22) Filed: **Jul. 12, 2016**

(51) **LOC (11) Cl.** ..... **16-06**

(52) **U.S. Cl.**  
USPC ..... **D16/325; D16/300**

(58) **Field of Classification Search**  
USPC ..... D16/300, 309, 311-315, 319-322,  
D16/325-330, 334, 335

CPC ..... G02C 2202/16; G02C 7/10; G02C 7/104  
See application file for complete search history.

(56) **References Cited**

**U.S. PATENT DOCUMENTS**

D660,903 S *	5/2012	Sheldon	.....	D16/326
D689,116 S *	9/2013	Chen	.....	D16/309
D729,864 S *	5/2015	Chou	.....	D16/300
D740,350 S *	10/2015	Hsu	.....	D16/326
D746,364 S *	12/2015	Chen	.....	D16/311
D756,444 S *	5/2016	DiChiara	.....	D16/309
2005/0280771 A1 *	12/2005	DiChiara	.....	G02C 1/08 351/111
2010/0064422 A1 *	3/2010	DiChiara	.....	A61F 9/02 2/431

**OTHER PUBLICATIONS**

Lazer Magento M1 Sunglasses, posted at wiggle.co.uk, posting date not given, [online], [site visited May 15, 2017]. Available from Internet <URL: <http://www.wiggle.co.uk/lazer-magneto-m1-sunglasses-photochromic-2012/>>.\*

\* cited by examiner

*Primary Examiner* — Caron D Veynar

*Assistant Examiner* — Maria Edwards

(74) *Attorney, Agent, or Firm* — Mitchell Law PLLC;  
Matthew W. Mitchell

(57) **CLAIM**

The ornamental design for temple-help sunglasses, as shown.

**DESCRIPTION**

FIG. 1 is a front perspective view showing my new design; FIG. 2 is a front view of the invention; FIG. 3 is a back view of the invention; FIG. 4 is a side view of the invention, as seen from the left side of FIG. 2; FIG. 5 is a side view of the invention, as seen from the right side of FIG. 2; FIG. 6 is a bottom plan view of the invention; and, FIG. 7 is a top plan view in elevation of the invention.

**1 Claim, 4 Drawing Sheets**

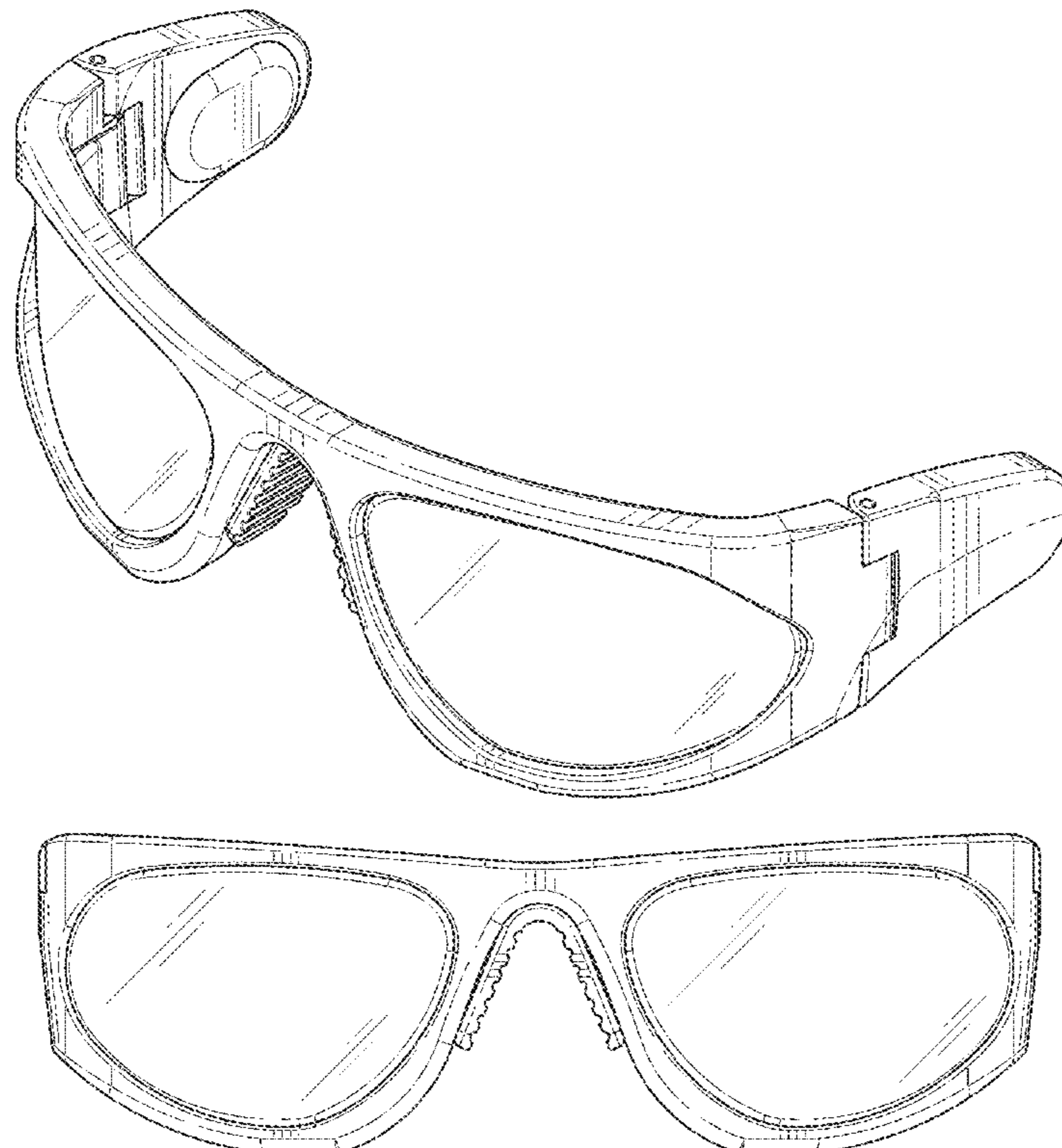

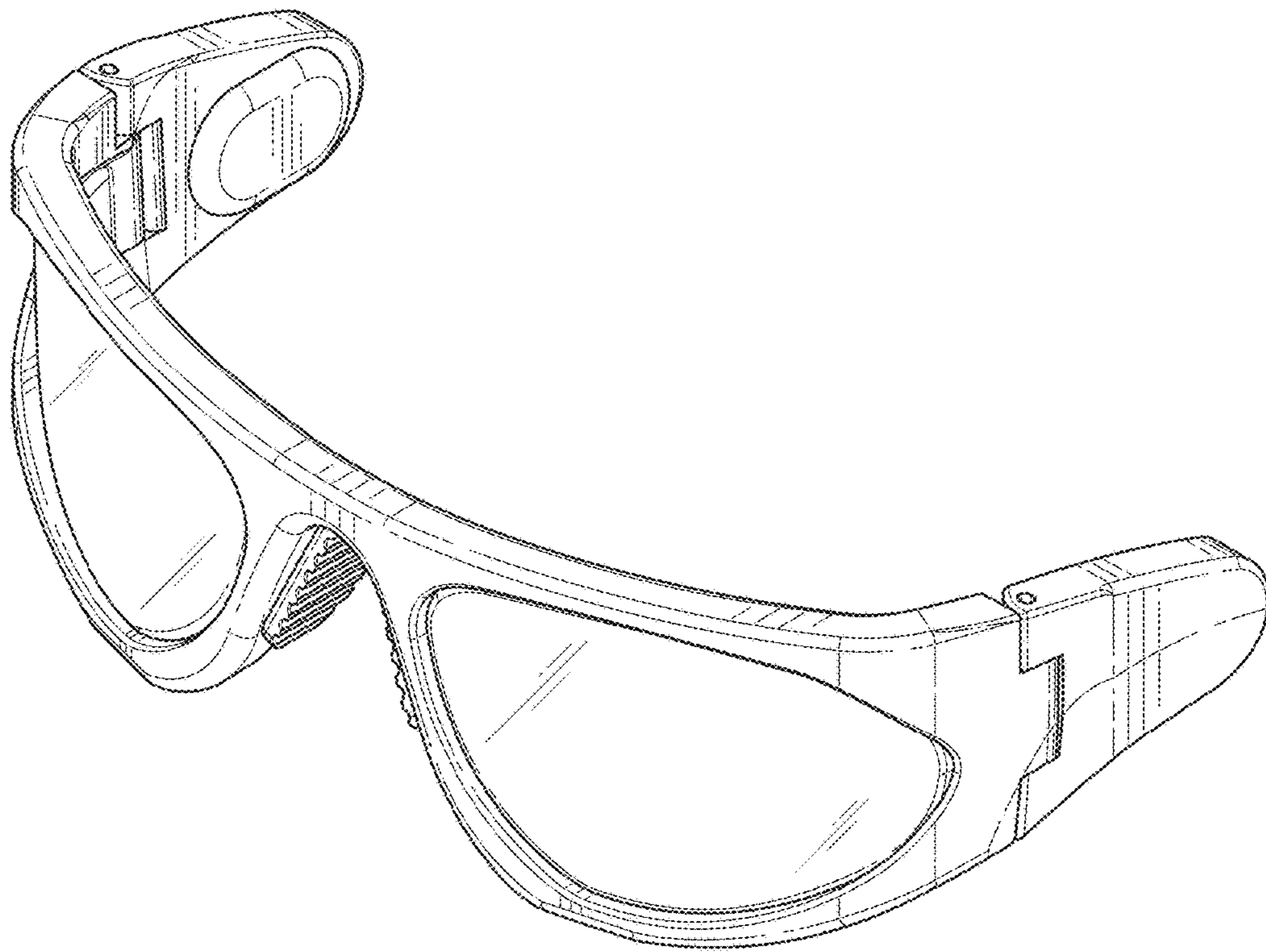

FIG. 1

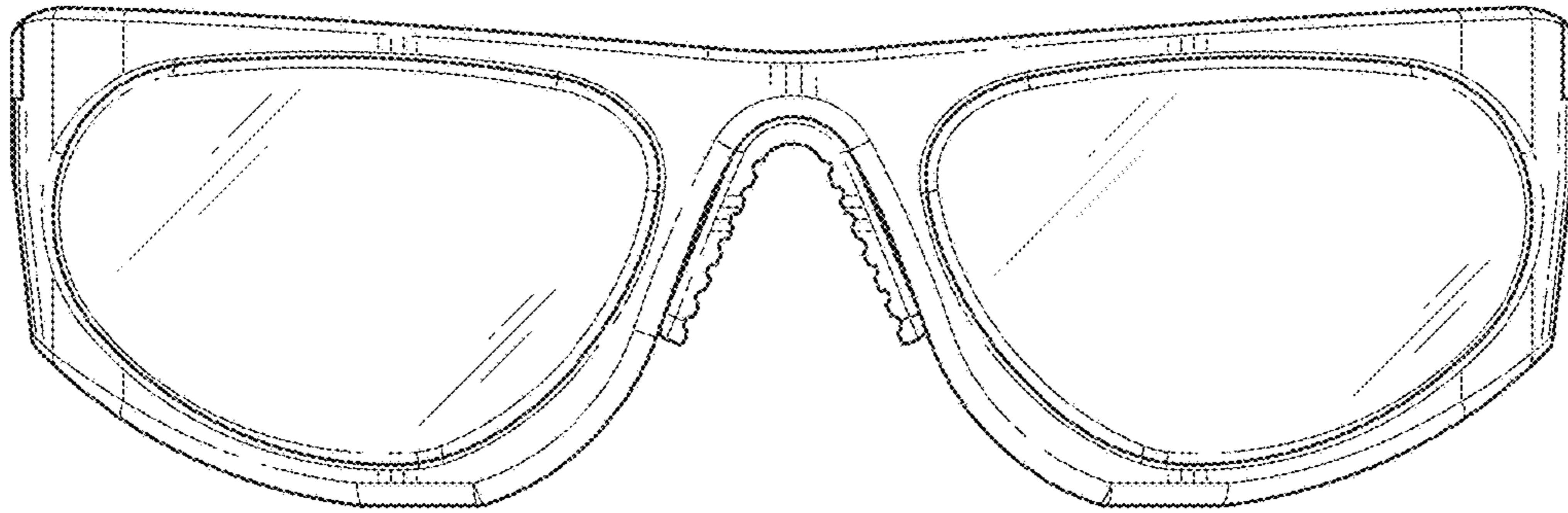

FIG. 2

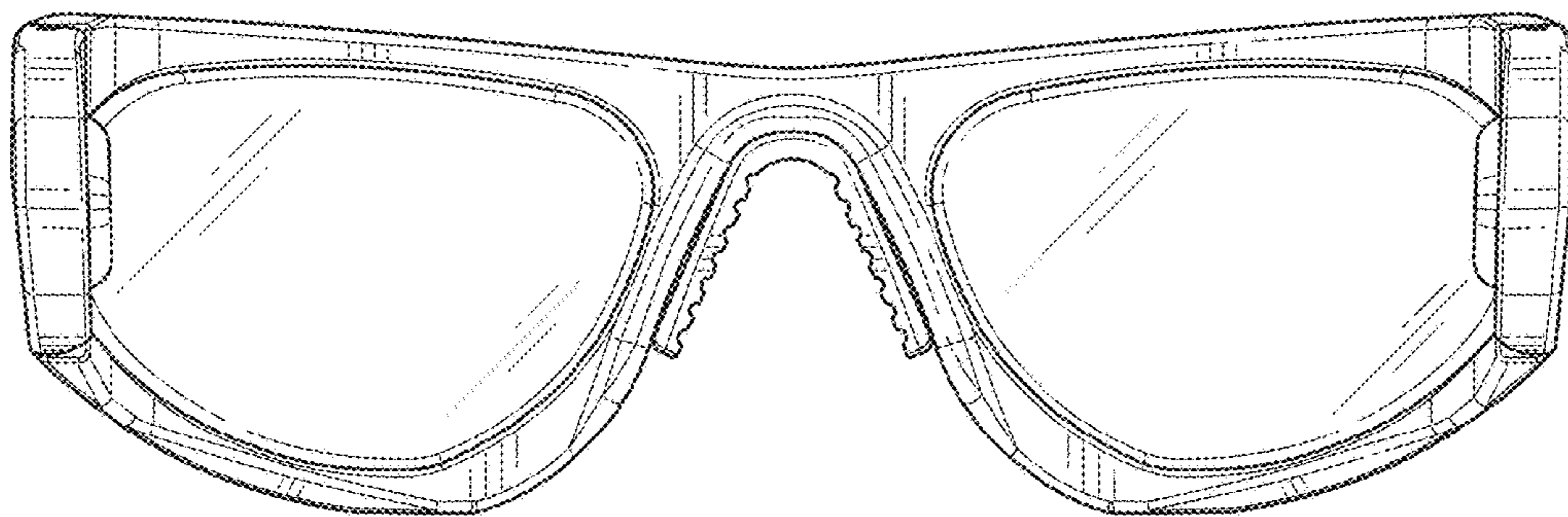

FIG. 3

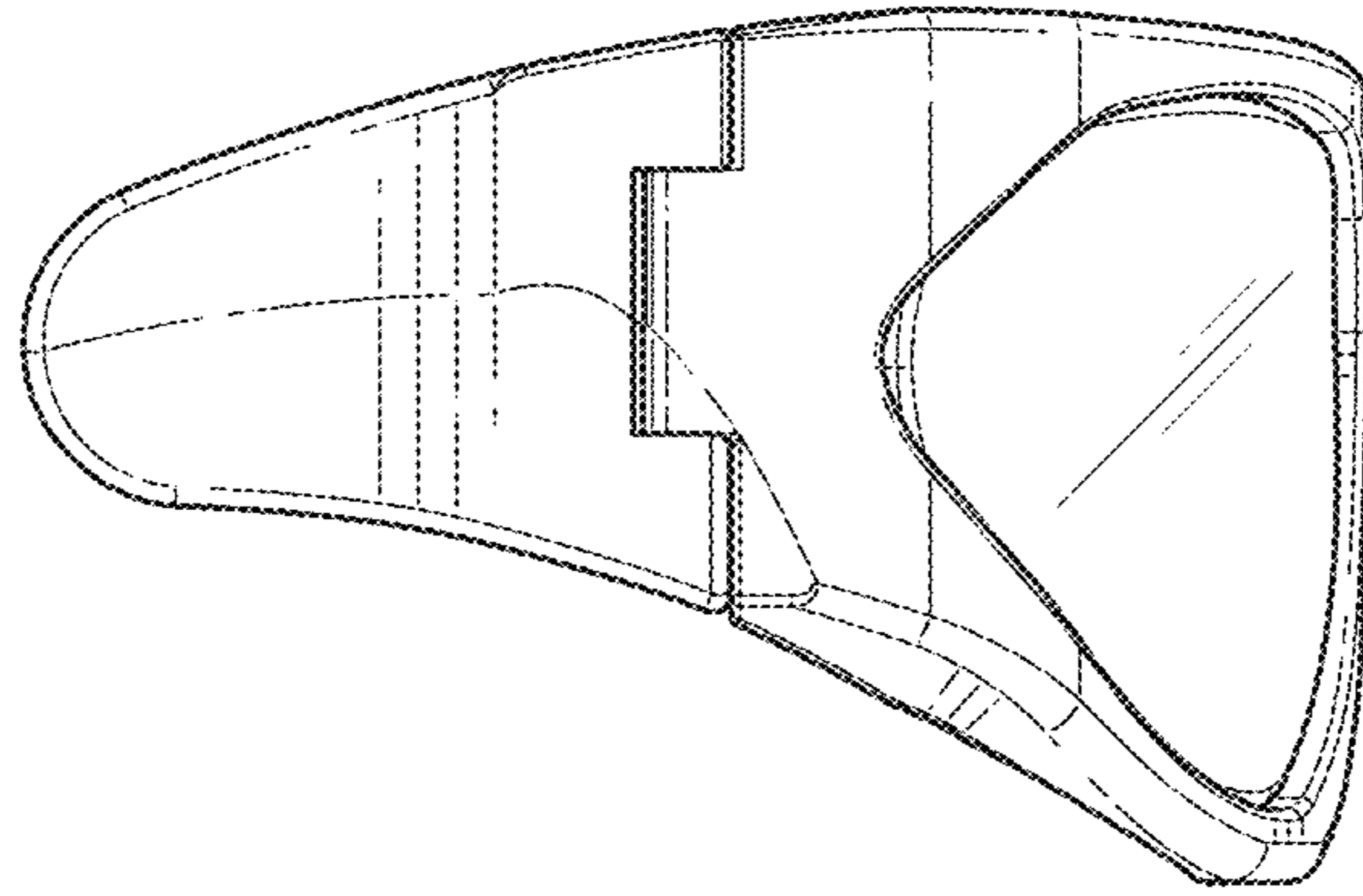

FIG. 4

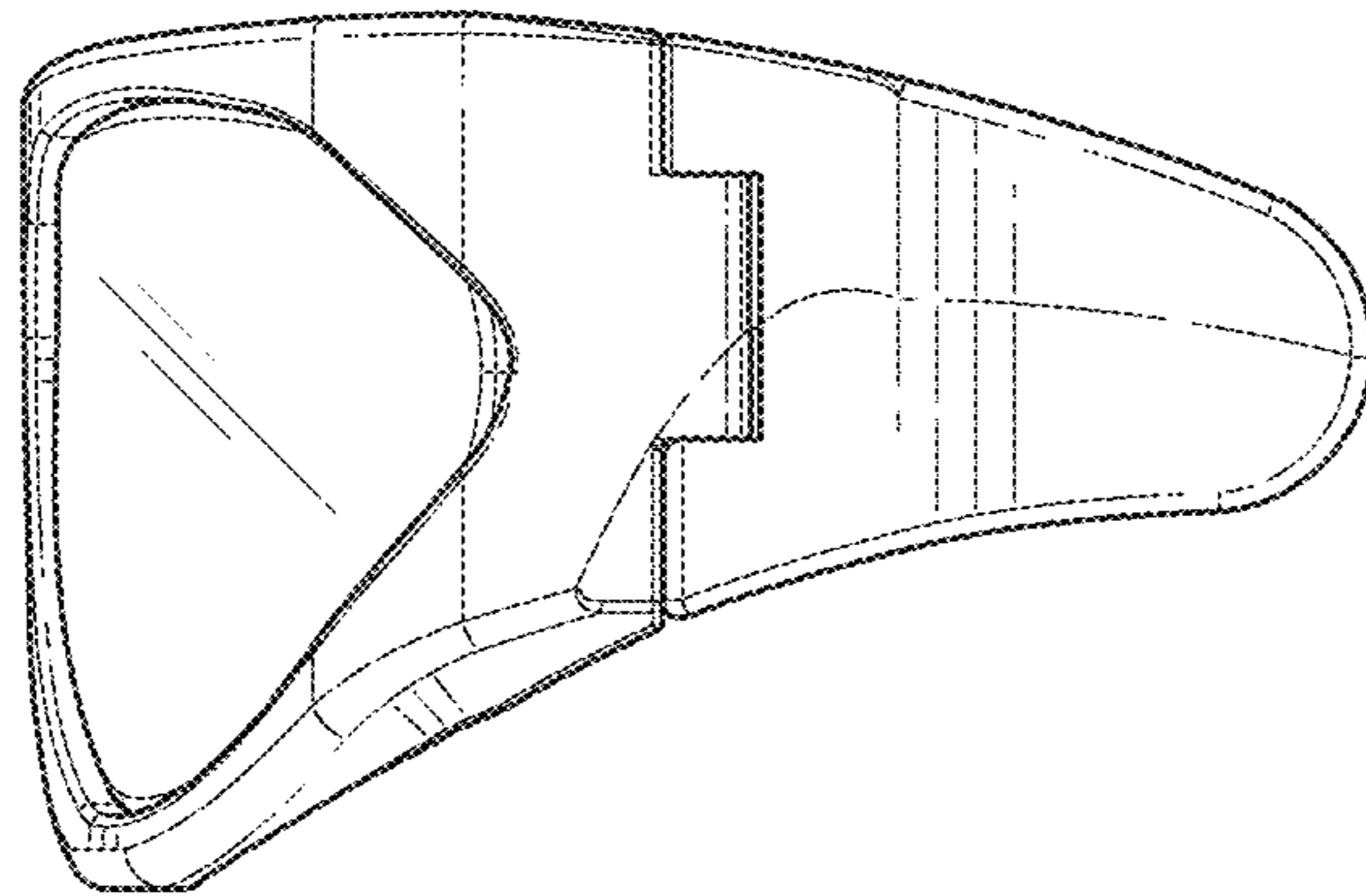

FIG. 5

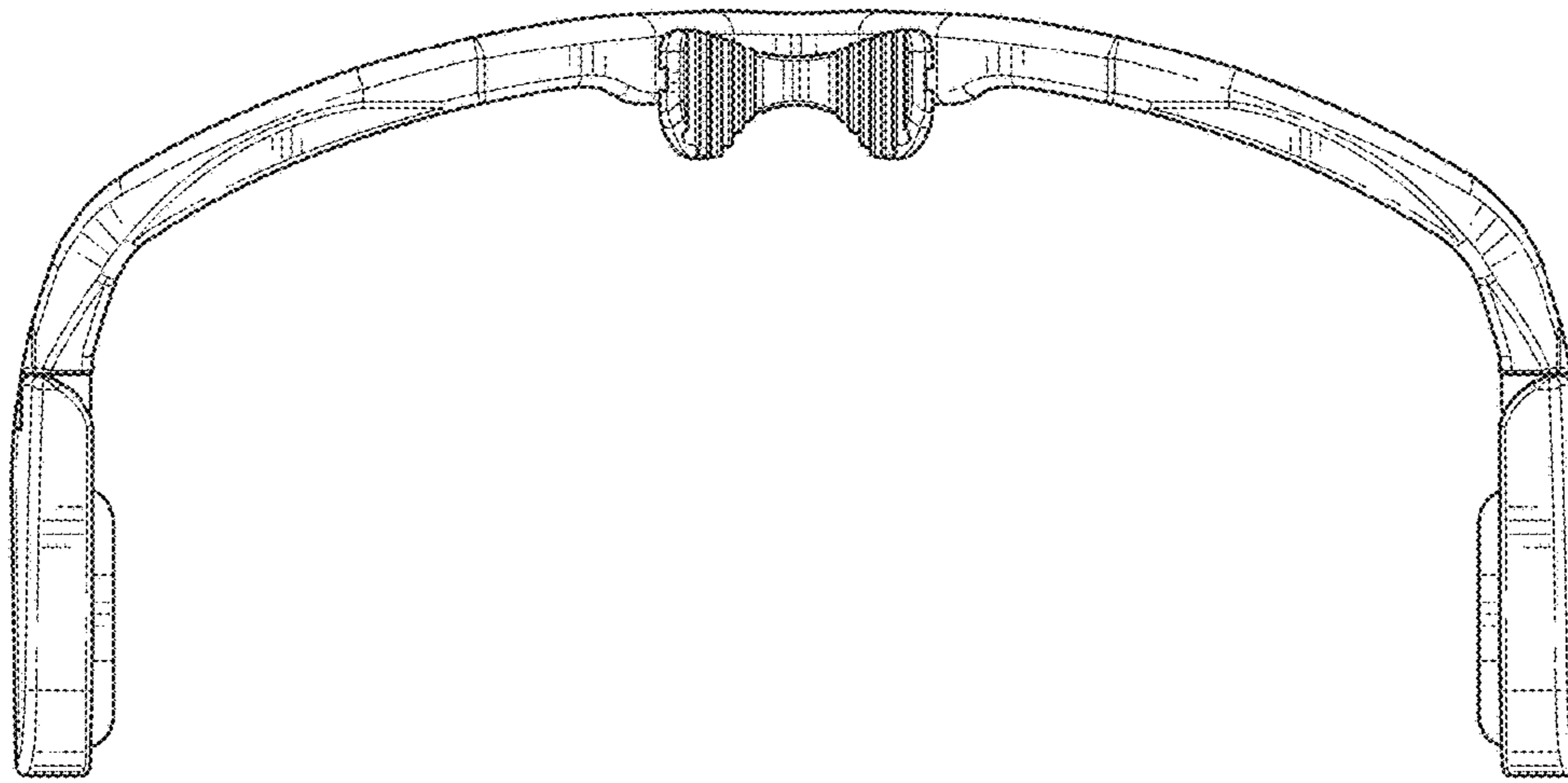

FIG. 6

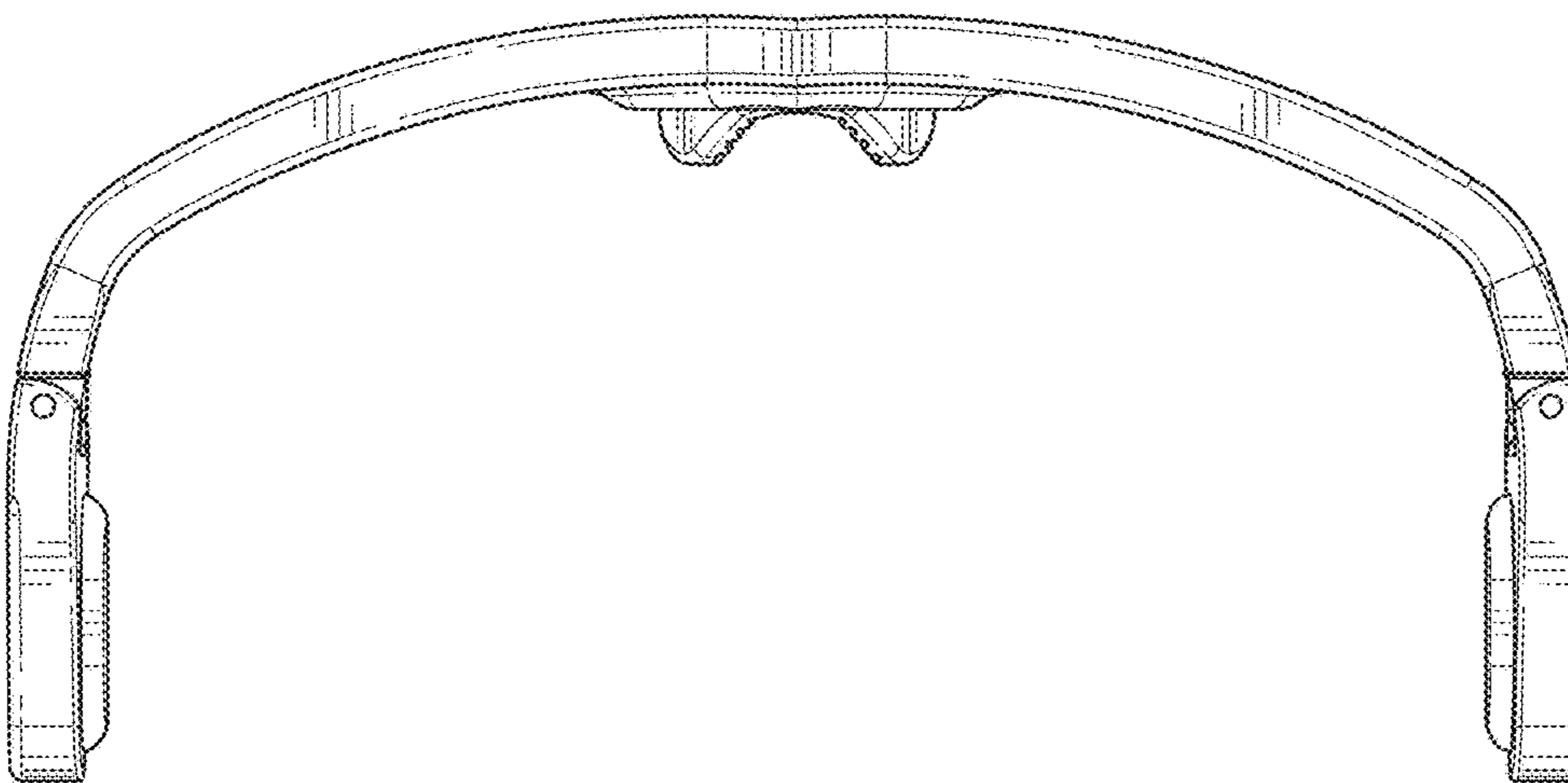

FIG. 7