



US00D824362S

(12) **United States Design Patent**
Probst et al.

(10) **Patent No.:** **US D824,362 S**
(45) **Date of Patent:** **** Jul. 31, 2018**

(54) **HEADSET**

(71) Applicant: **Dell Products L.P.**, Round Rock, TX (US)

(72) Inventors: **Joshua Y. Probst**, Austin, TX (US);
Shih-Heng Chen, Taipei (TW);
Michael Ellis Smith, Austin, TX (US)

(73) Assignee: **Dell Products L.P.**, Round Rock, TX (US)

(**) Term: **15 Years**

(21) Appl. No.: **29/598,673**

(22) Filed: **Mar. 28, 2017**

(51) **LOC (11) Cl.** **14-01**

(52) **U.S. Cl.**
USPC **D14/206**; D14/226

(58) **Field of Classification Search**
USPC D14/206, 226, 205, 188, 192; D29/112;
2/209; 181/129, 130, 135; 379/430, 431;
381/380, 381, 370, 375, 382, 183, 374;
455/90.3, 575.1, 569.1
CPC H04R 1/1066; H04R 1/1016; H04R 25/00;
H04R 1/105; H04R 5/033; H04R 5/0335;
H04R 1/1091; H04R 1/1058
See application file for complete search history.

(56) **References Cited**

U.S. PATENT DOCUMENTS

- 3,681,540 A * 8/1972 Thomson H04R 1/1066
381/374
- D244,037 S * 4/1977 Warner D14/205
- D244,300 S * 5/1977 Besasie D14/205
- 4,173,715 A * 11/1979 Gosnnan H04R 1/1058
181/129
- D254,183 S * 2/1980 Doodson D14/205
- D254,910 S * 5/1980 Lung D14/168
- D255,352 S * 6/1980 Besasie D14/205

- D266,417 S * 10/1982 Perez D14/165
- 4,551,584 A * 11/1985 Mathiasen H04R 1/1066
2/209
- D286,632 S * 11/1986 Teunis D14/205

(Continued)

Primary Examiner — Paula Allen Greene
(74) *Attorney, Agent, or Firm* — Zagorin Cave LLP;
Robert W. Holland

(57) **CLAIM**

We claim the ornamental design for the headset, as shown and described.

DESCRIPTION

FIG. 1 is a front perspective view of an ornamental headset design comprising the present invention;
 FIG. 2 is a front elevation view thereof;
 FIG. 3 is a rear elevation view thereof;
 FIG. 4 is a right side view thereof;
 FIG. 5 is a left side view thereof;
 FIG. 6 is a top view thereof;
 FIG. 7 is a bottom view thereof;
 FIG. 8 is a bottom perspective view thereof;
 FIG. 9 is a front perspective view thereof with microphone extended;
 FIG. 10 is a front elevation view thereof with microphone extended;
 FIG. 11 is a rear elevation view thereof with microphone extended;
 FIG. 12 is a right side view thereof with microphone extended;
 FIG. 13 is a left side view thereof with microphone extended;
 FIG. 14 is a top view thereof with microphone extended;
 FIG. 15 is a bottom view thereof with microphone extended;
 and,
 FIG. 16 is bottom perspective view thereof with microphone extended.
 Broken lines shown in the drawings illustrate portions of the headset, and form no part of the claimed design.

1 Claim, 15 Drawing Sheets

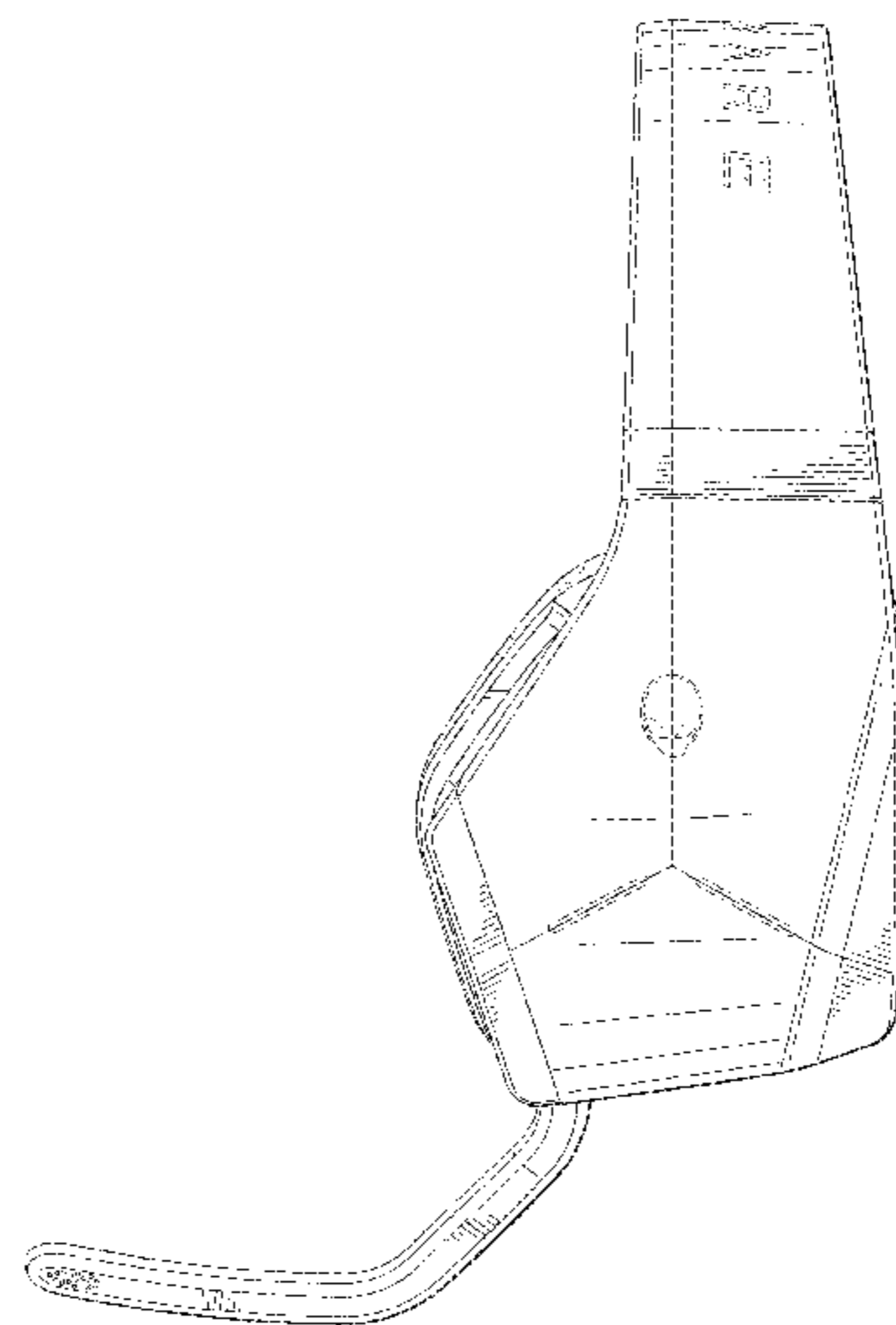
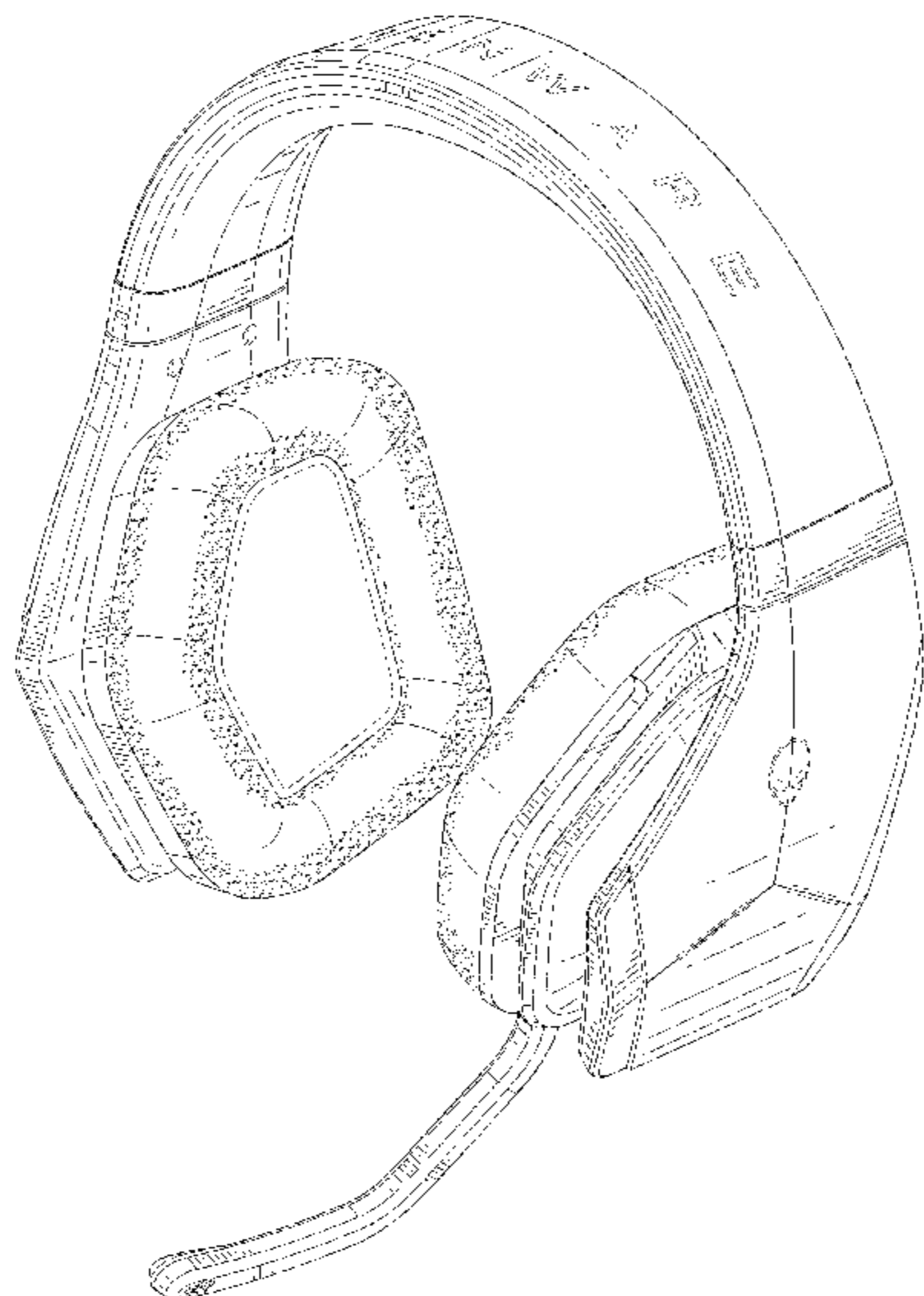

(56)

References Cited

U.S. PATENT DOCUMENTS

D299,025 S *	12/1988	Besasie	D14/205	D542,774 S *	5/2007	Rausch	D14/206
4,821,318 A *	4/1989	Wu	H04M 1/05	D576,604 S *	9/2008	Suzuki	D14/205
				379/430	D613,266 S *	4/2010	Barry	D14/205
D302,429 S *	7/1989	Leer	D14/137	D617,769 S *	6/2010	Birger	D14/205
4,987,592 A *	1/1991	Flagg	H04M 1/05	D617,771 S *	6/2010	Groves	D14/205
				379/430	D638,397 S *	5/2011	McManigal	D14/205
D317,767 S *	6/1991	Banks	D14/205	D641,727 S *	7/2011	Krauss	D14/206
D318,053 S *	7/1991	Ludeke	D14/205	D645,023 S *	9/2011	Brandis	D14/206
5,113,428 A *	5/1992	Fitzgerald	H04B 1/385	D652,017 S *	1/2012	Groves	D14/206
				379/430	D656,480 S *	3/2012	McManigal	D14/205
5,138,722 A *	8/1992	Urella	A61F 11/14	8,139,807 B2 *	3/2012	Reiss	H04R 1/1083
				2/209					381/371
D333,137 S *	2/1993	Burke	D14/206	D661,684 S *	6/2012	Frey	D14/205
5,185,807 A *	2/1993	Bergin	H04R 1/1066	D662,490 S *	6/2012	McSweyn	D14/205
				181/128	D666,991 S *	9/2012	Lee	D14/205
D342,947 S *	1/1994	Totsuka	D14/192	D672,744 S *	12/2012	Scarpa	D14/205
D346,380 S *	4/1994	Fitzgerald	D14/138 R	D672,745 S *	12/2012	Abed	D14/205
D358,390 S *	5/1995	Hayashi	D14/205	D678,859 S *	3/2013	Lee	D14/205
D359,049 S *	6/1995	Kanno	D14/205	D684,949 S *	6/2013	Lee	D14/205
5,519,783 A *	5/1996	Kumar	H04R 1/1008	D689,464 S *	9/2013	Bonahoonn	D14/206
				181/129	D691,111 S *	10/2013	Lee	D14/206
5,590,213 A *	12/1996	Urella	H04R 5/0335	D693,327 S *	11/2013	Chiu	D14/206
				381/370	D693,791 S *	11/2013	Troy	D14/205
D381,987 S *	8/1997	Tsuge	D14/205	D697,495 S *	1/2014	Lian	D14/205
5,793,878 A *	8/1998	Chang	H04R 5/0335	D699,216 S *	2/2014	Bonahoonn	D14/205
				381/370	D713,375 S *	9/2014	Dedinas	D14/206
5,794,127 A *	8/1998	Lansang	H04R 1/1041	D717,764 S *	11/2014	Lee	D14/205
				340/12.5	D791,734 S *	7/2017	Ou	D14/206
D409,197 S *	5/1999	Nakamura	D14/205	D800,091 S *	10/2017	Paterson	D14/206
D456,379 S *	4/2002	Fitzgerald	D14/142	D800,092 S *	10/2017	Paterson	D14/206
7,031,475 B2 *	4/2006	Kuraoka	H04M 1/0289	D806,675 S *	1/2018	Fuglsang	D14/206
				379/428.02	2001/0017925 A1 *	8/2001	Ceravolo	H04M 1/05
D530,307 S *	10/2006	Rath	D14/206					381/370
					2011/0194721 A1 *	8/2011	Schmidt	H04R 1/1066
									381/370

* cited by examiner

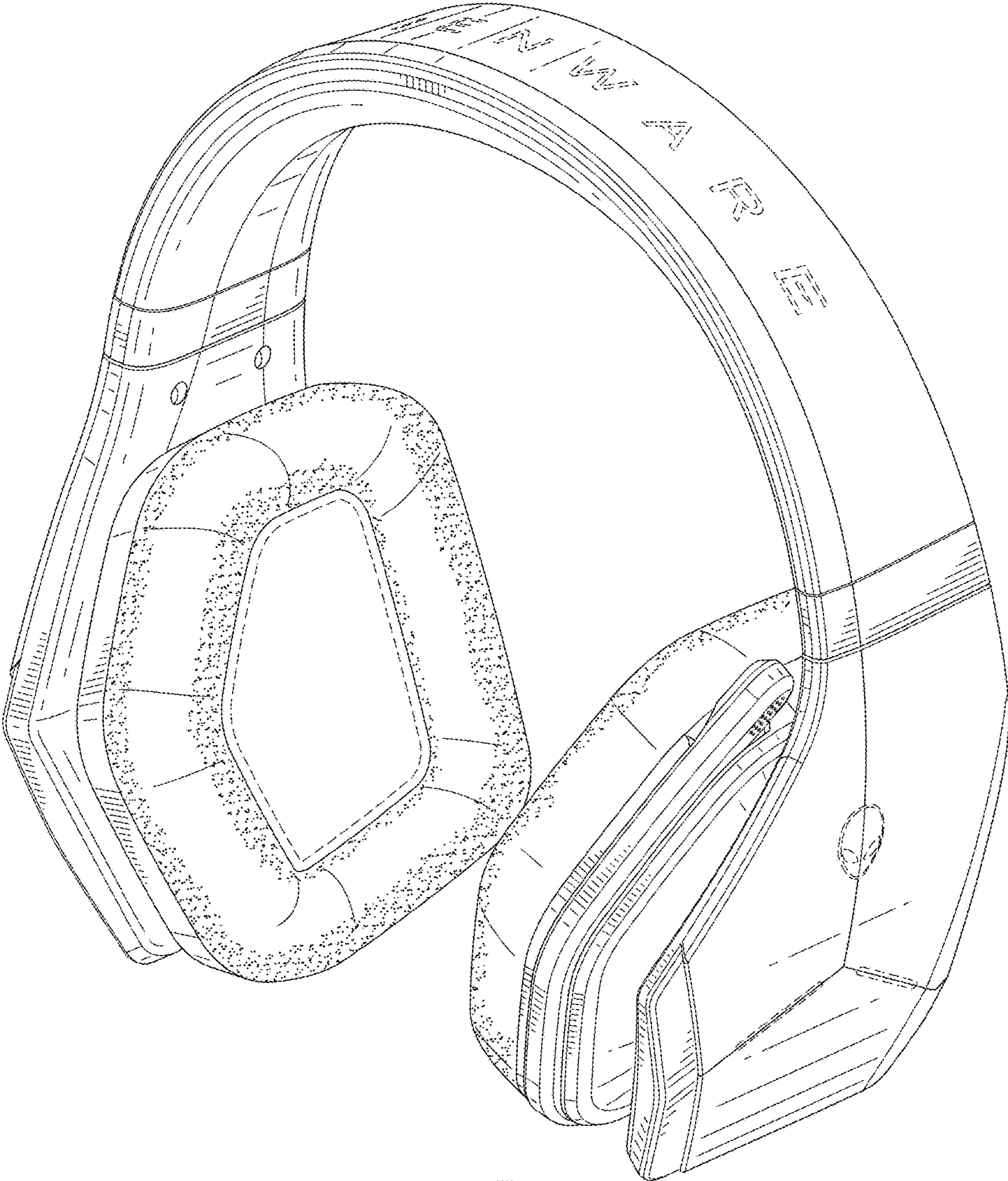

FIG. 1



FIG. 2



FIG. 3

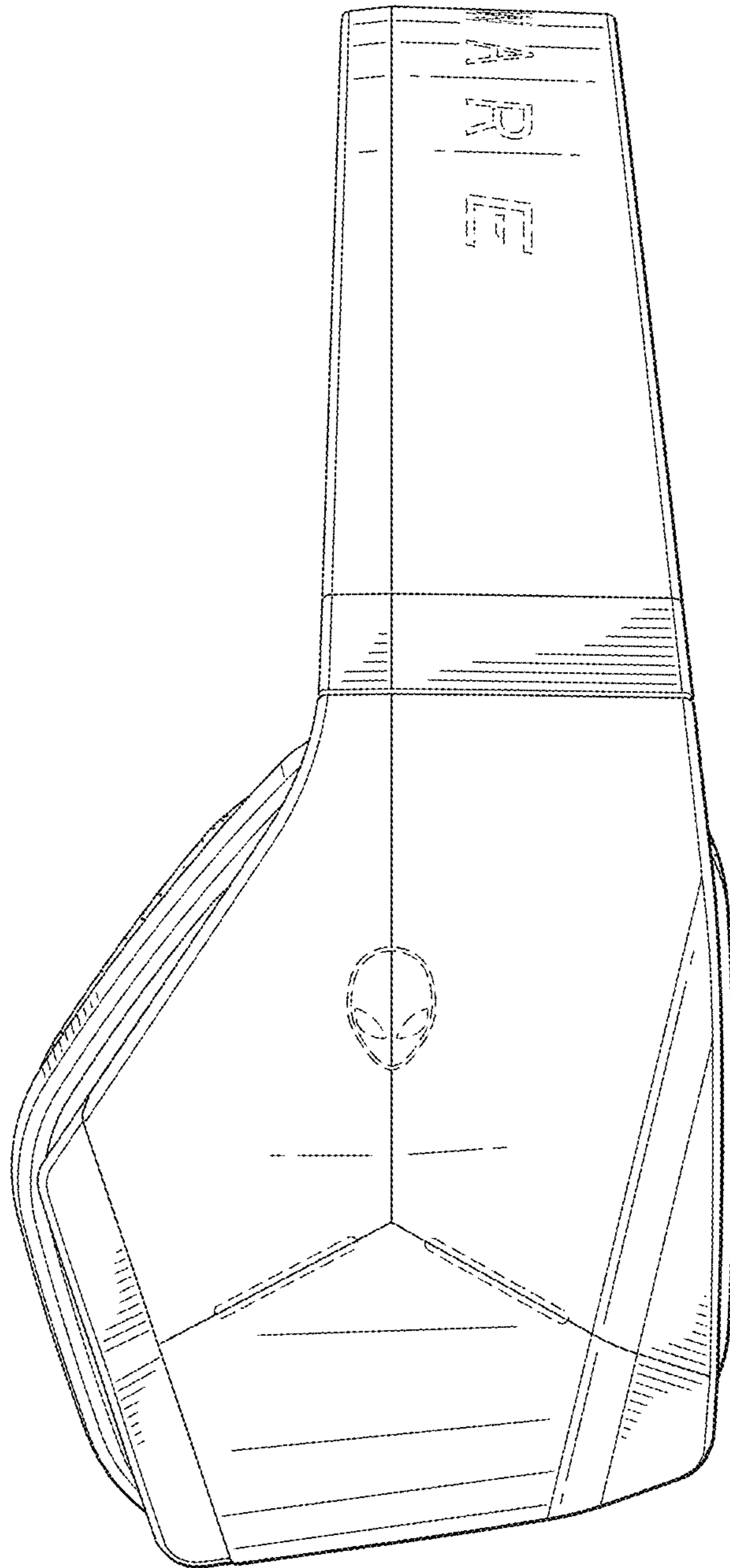

FIG. 4

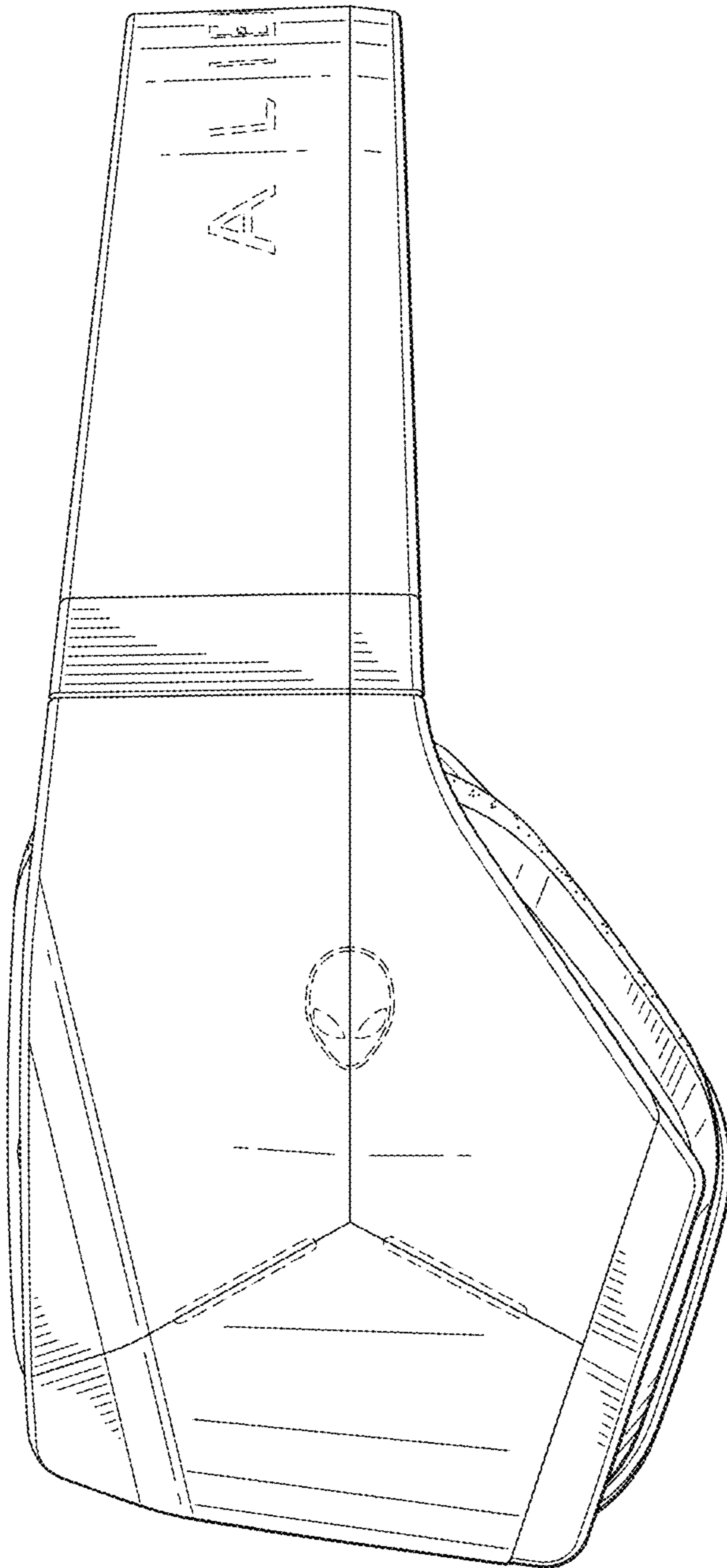

FIG. 5

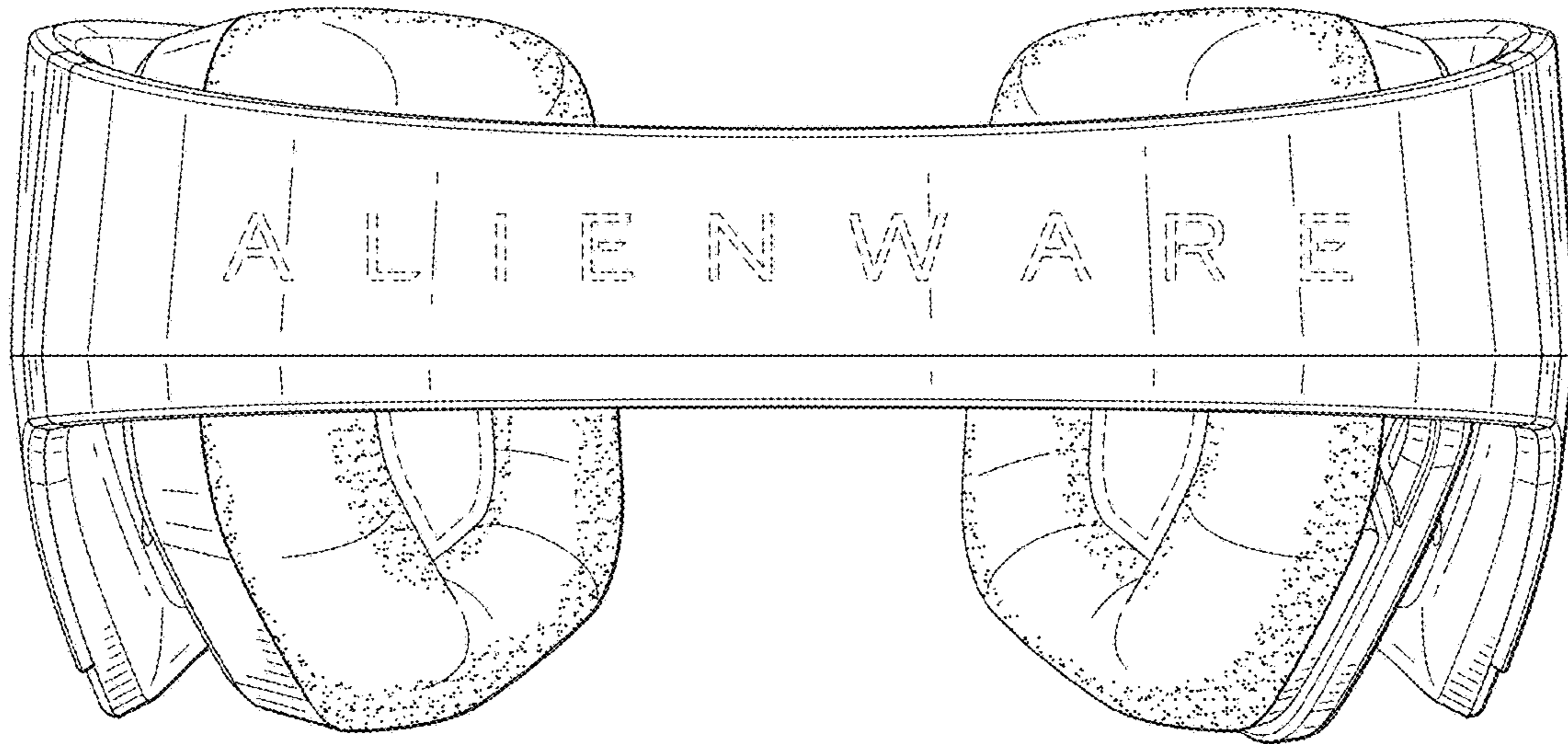

FIG. 6

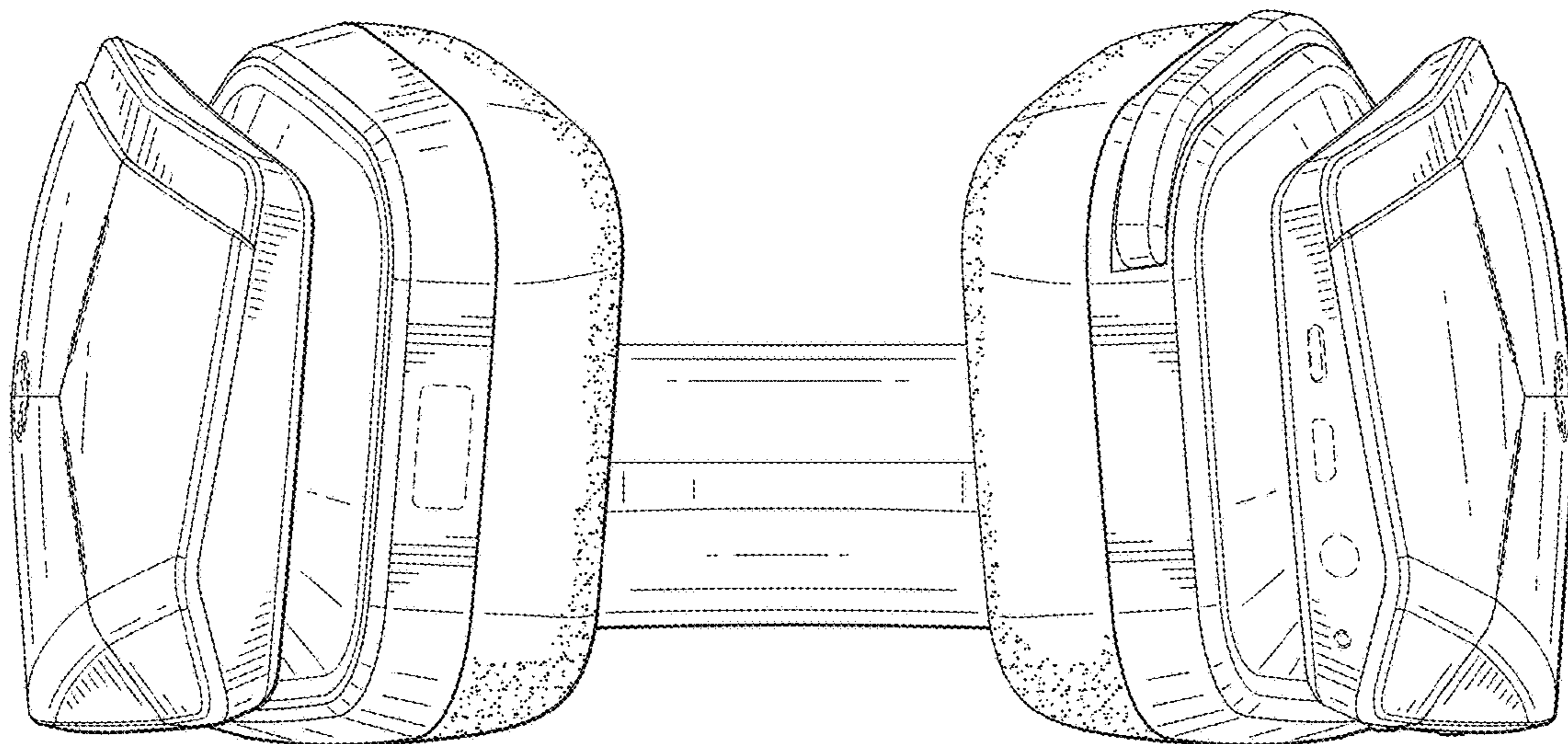

FIG. 7

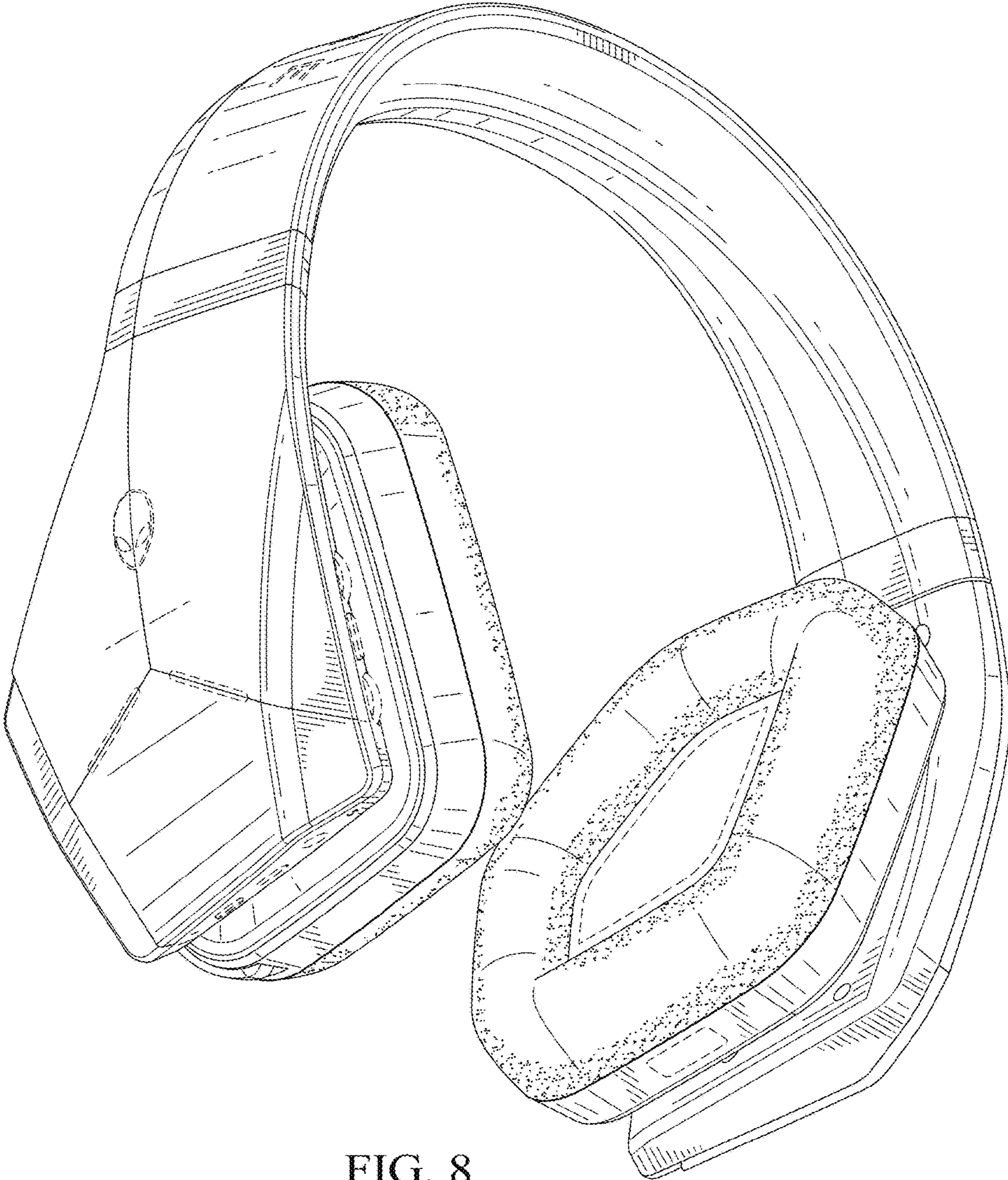

FIG. 8

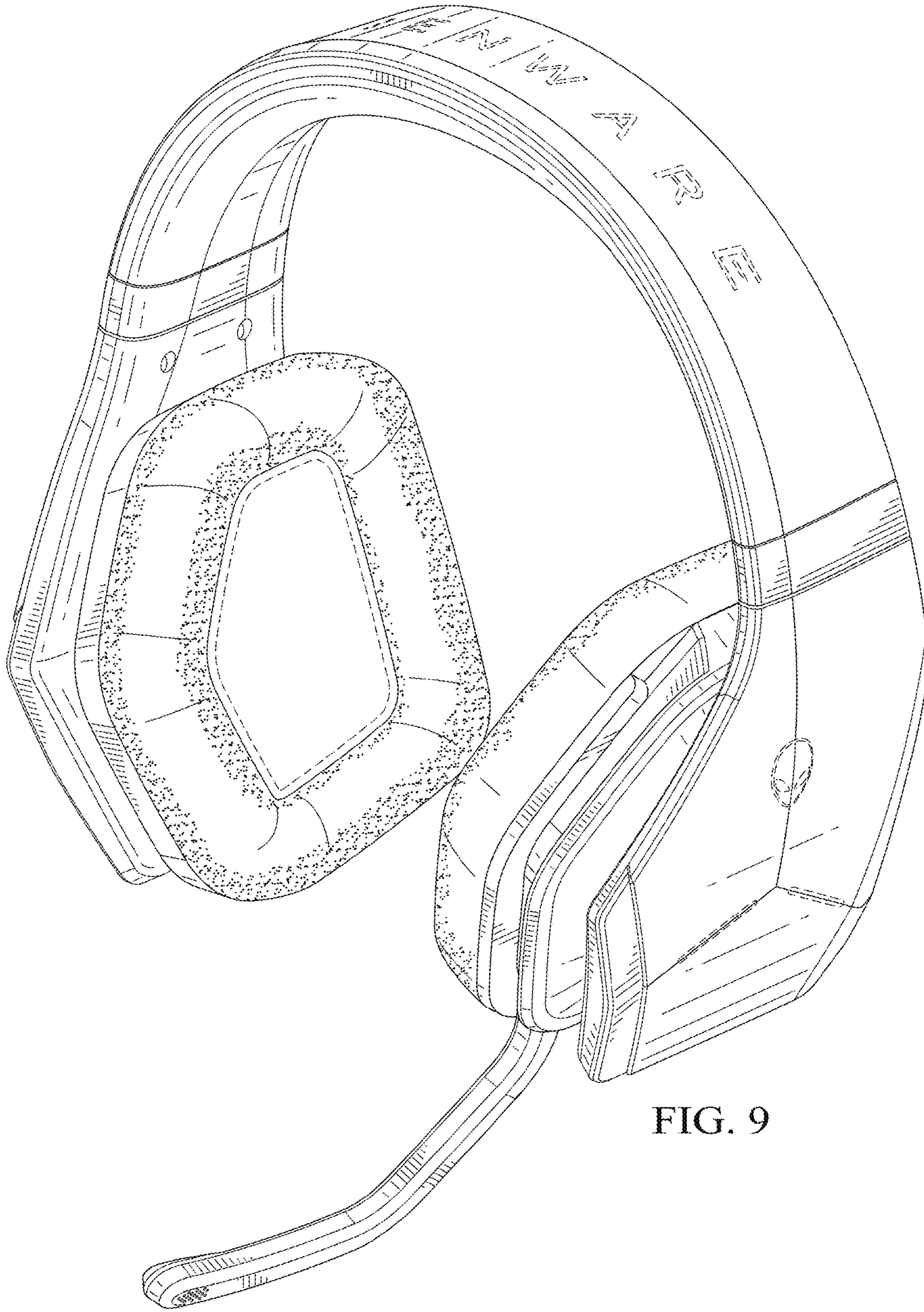

FIG. 9

FIG. 10



FIG. 11



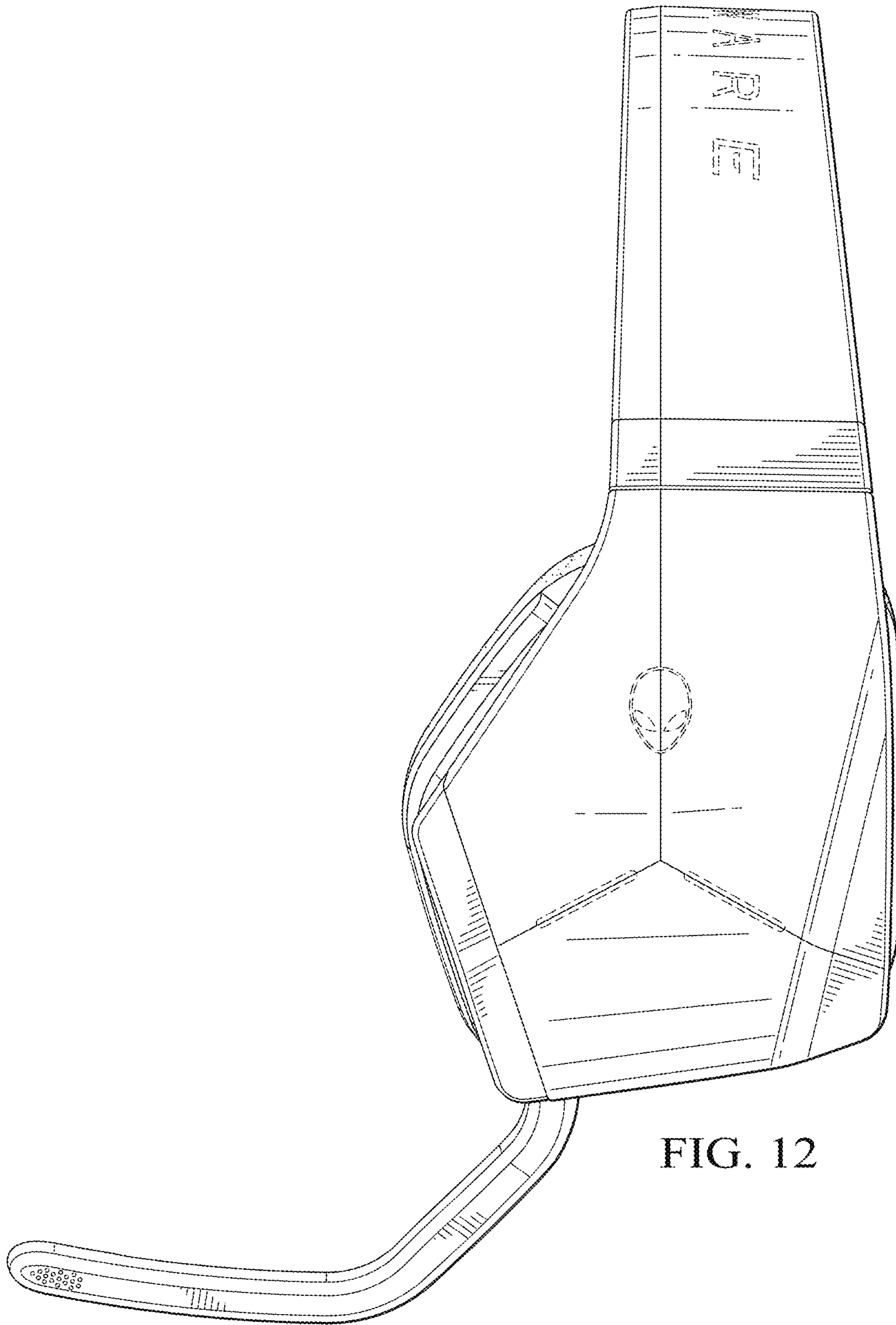

FIG. 12

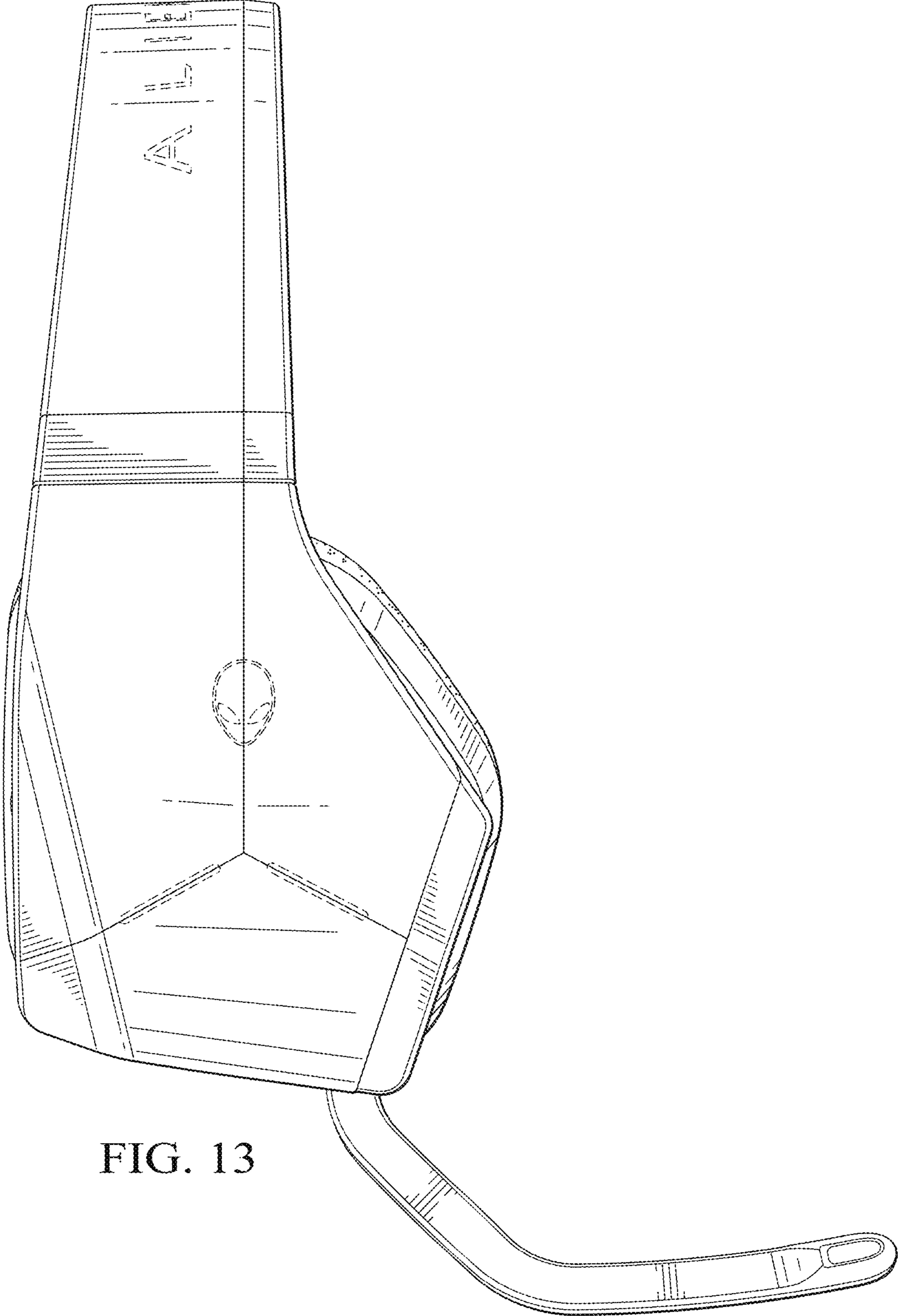
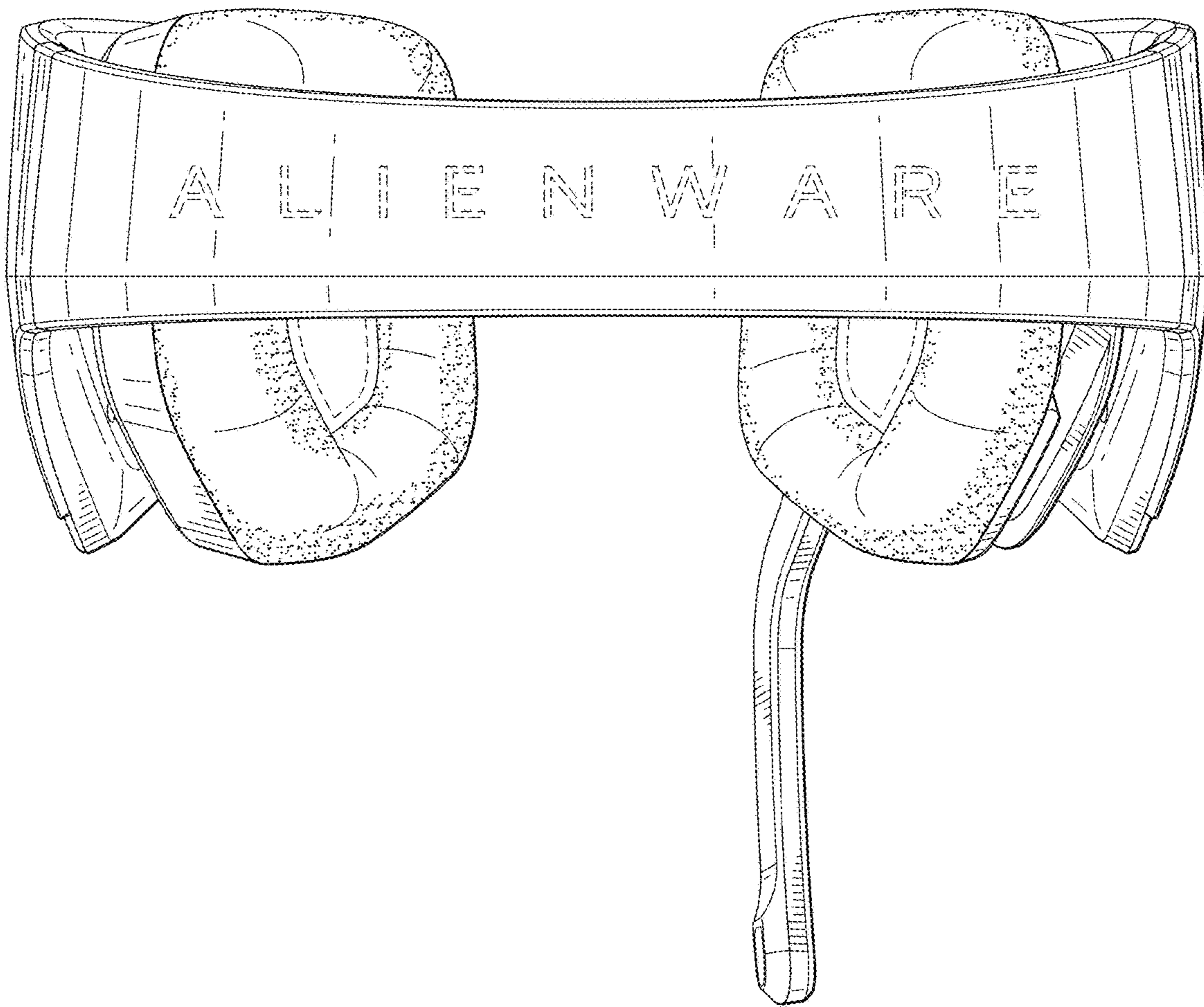

FIG. 13

FIG. 14



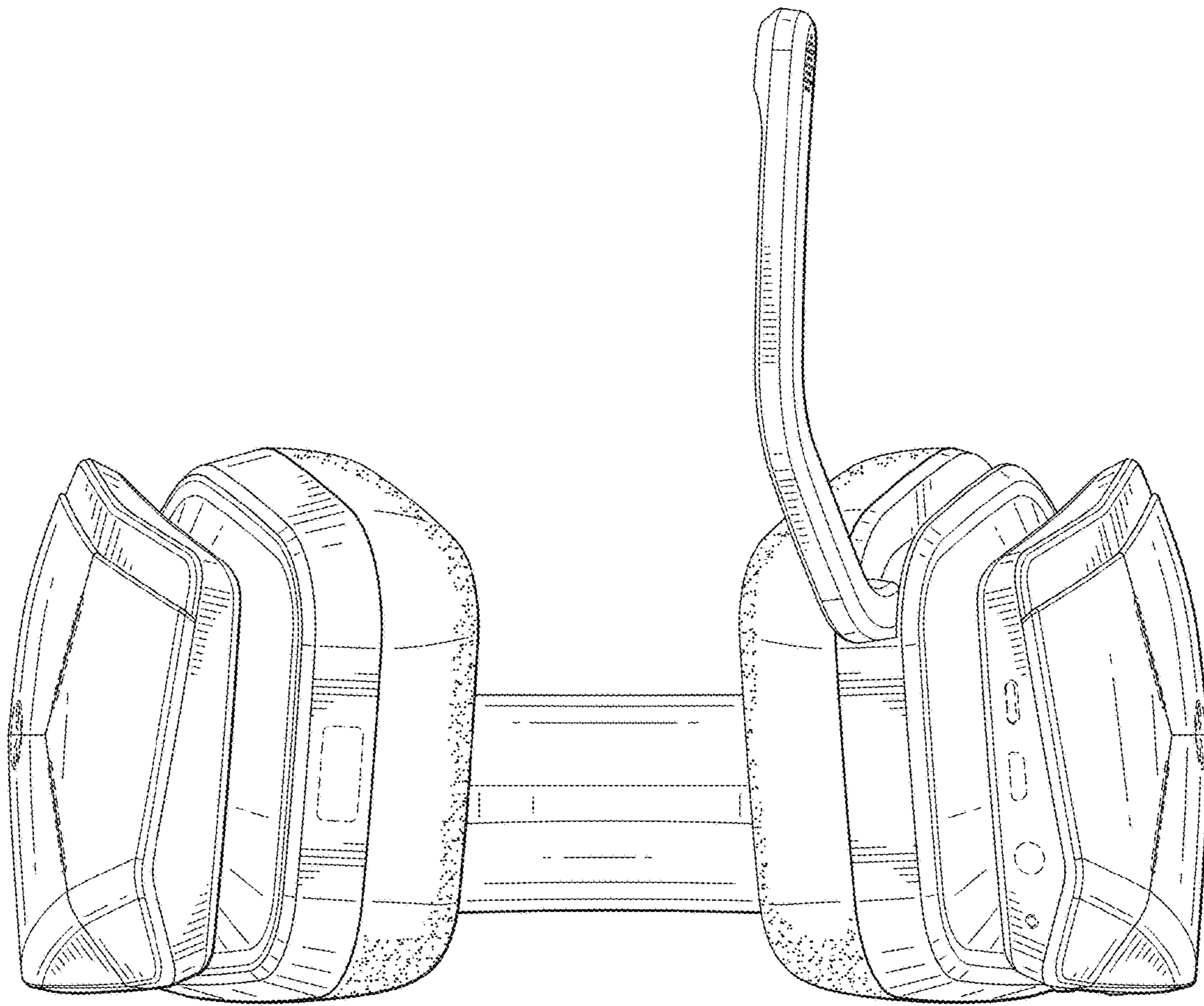

FIG. 15

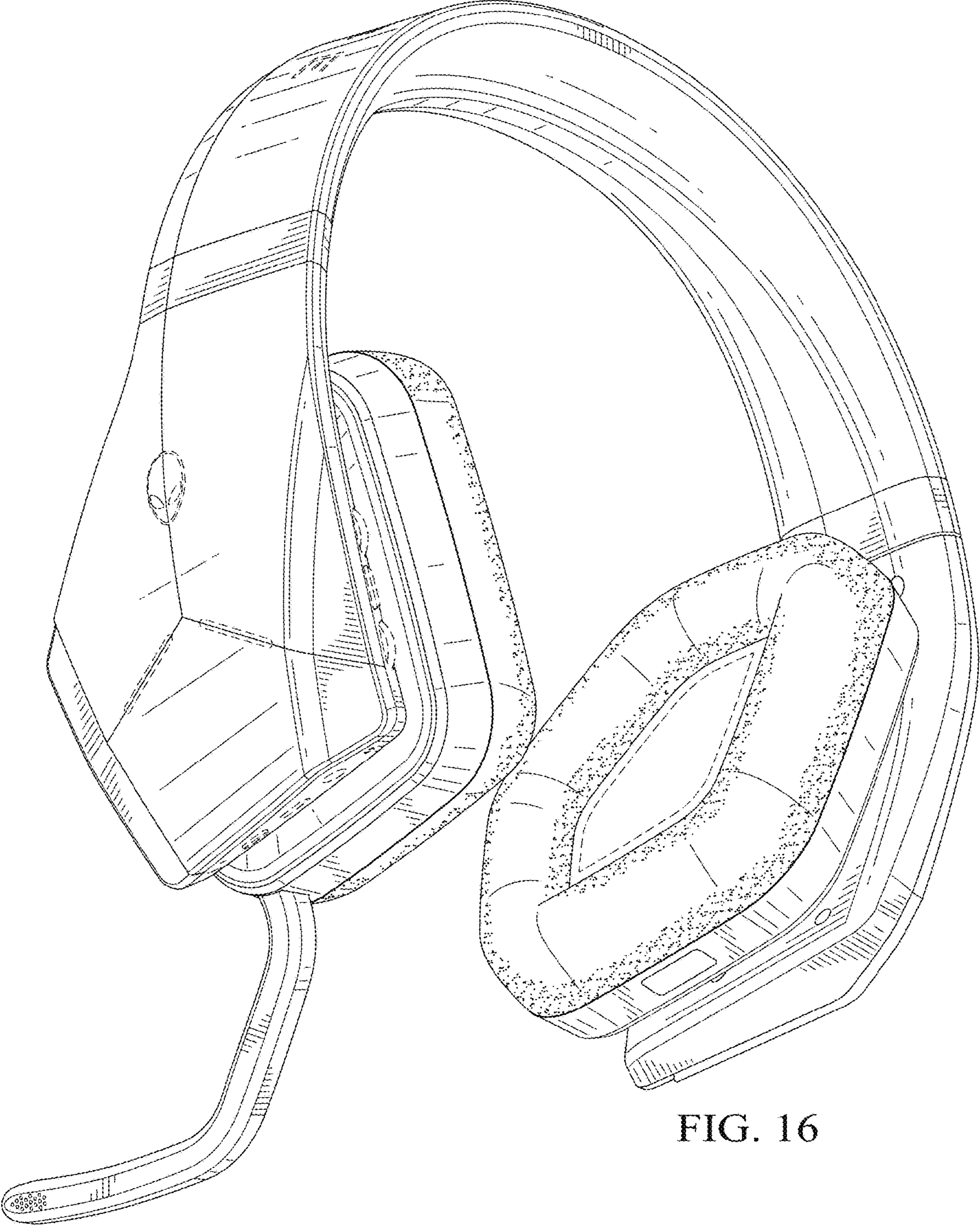

FIG. 16