



US00D824327S

(12) **United States Design Patent** (10) **Patent No.:** **US D824,327 S**
Kim et al. (45) **Date of Patent:** **** Jul. 31, 2018**

(54) **AUXILIARY RECHARGEABLE BATTERY**

(56) **References Cited**

(71) Applicant: **LG ELECTRONICS INC.**, Seoul (KR)

U.S. PATENT DOCUMENTS

(72) Inventors: **Dongsoon Kim**, Seoul (KR); **Seungyup Lee**, Seoul (KR)

D481,995 S *	11/2003	Yokota	D13/103
D538,803 S *	3/2007	Chen	D14/348
D684,916 S *	6/2013	Ashida	D12/332
D733,043 S *	6/2015	Hasbrook	D13/103
D743,333 S *	11/2015	Nomi	D13/108
D758,302 S *	6/2016	Walker	D13/103
D771,561 S *	11/2016	Walker	D13/103
D803,156 S *	11/2017	Motoyama	D13/119
D815,038 S *	4/2018	Park	D13/108

(73) Assignee: **LG ELECTRONICS INC.**, Seoul (KR)

(**) Term: **15 Years**

* cited by examiner

(21) Appl. No.: **35/503,177**

Primary Examiner — Michael A. Pratt

(22) Filed: **Dec. 16, 2016**

(74) *Attorney, Agent, or Firm* — Birch, Stewart, Kolasch & Birch, LLP

(80) **Hague Agreement Data**

Int. Filing Date: **Dec. 16, 2016**
 Int. Reg. No.: **DM/093998**
 Int. Reg. Date: **Dec. 16, 2016**
 Int. Reg. Pub. Date: **Jun. 16, 2017**

(57) **CLAIM**

The ornamental design for auxiliary rechargeable battery, as shown and described.

(30) **Foreign Application Priority Data**

Jun. 22, 2016 (KR) 30-2016-0030427

(51) **LOC (11) Cl.** **13-02**

(52) **U.S. Cl.**
USPC **D13/103**

(58) **Field of Classification Search**

USPC D13/103, 119
 CPC .. H01M 2/022; H01M 2/0202; H01M 2/0207;
 H01M 2/0212; H01M 2/1061; H01M
 2/1022; H01M 2/1055; H01M 2/1066;
 H01M 2/105; H01M 2/20; H01M 2/204;
 H01M 2/206; H01M 10/44; H01M 10/46;
 H01M 10/465; H01M 10/482; H01M
 2200/30; H01M 2250/30; H01M 2250/40

See application file for complete search history.

DESCRIPTION

1. Auxiliary rechargeable battery

- 1.1 : Perspective
- 1.2 : Front
- 1.3 : Back
- 1.4 : Left
- 1.5 : Right
- 1.6 : Top
- 1.7 : Bottom

The gist of the present ornamental design is a combination of shape and pattern of a “auxiliary rechargeable battery” as shown and described.

1 Claim, 7 Drawing Sheets

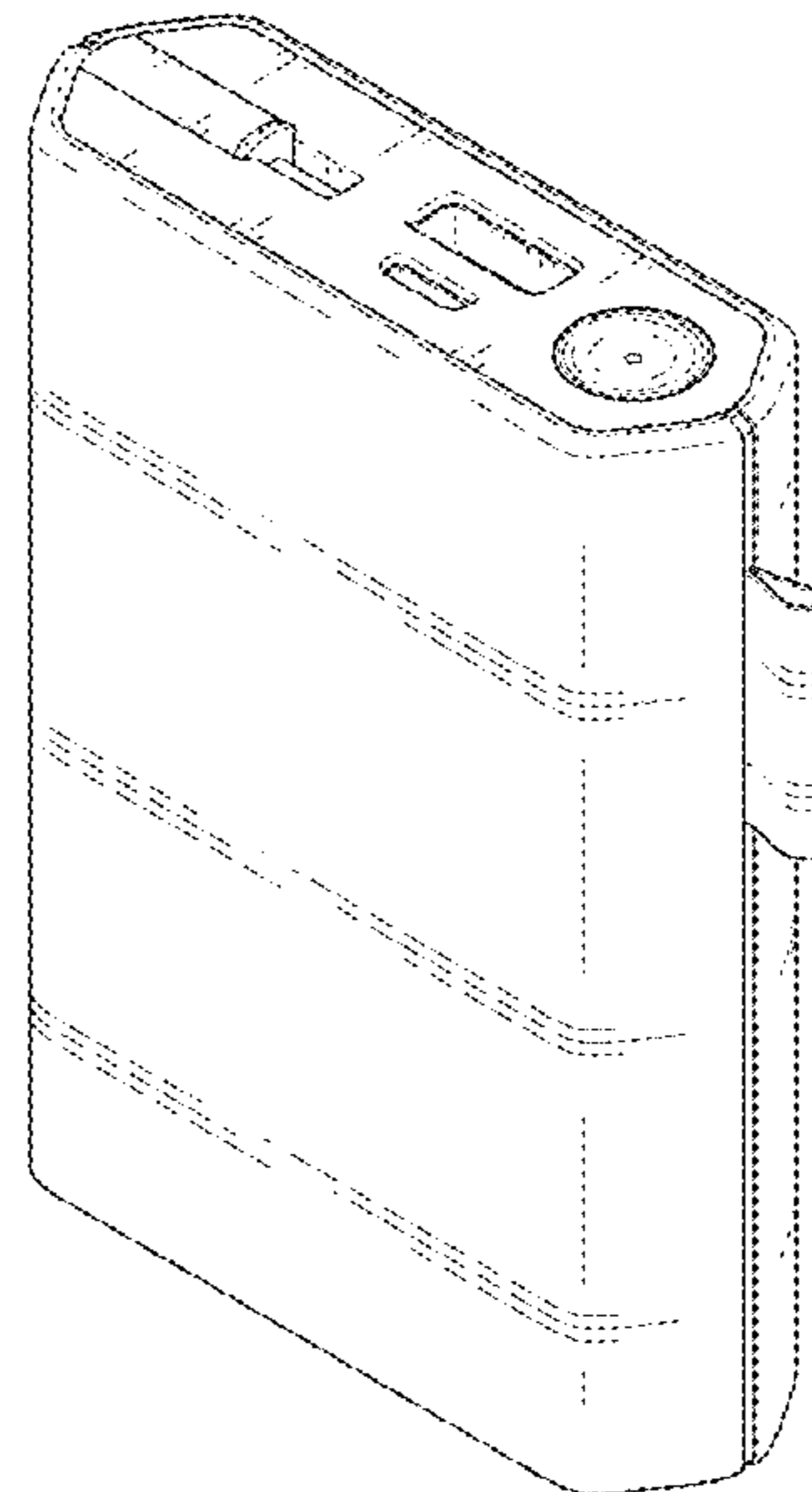

1.1

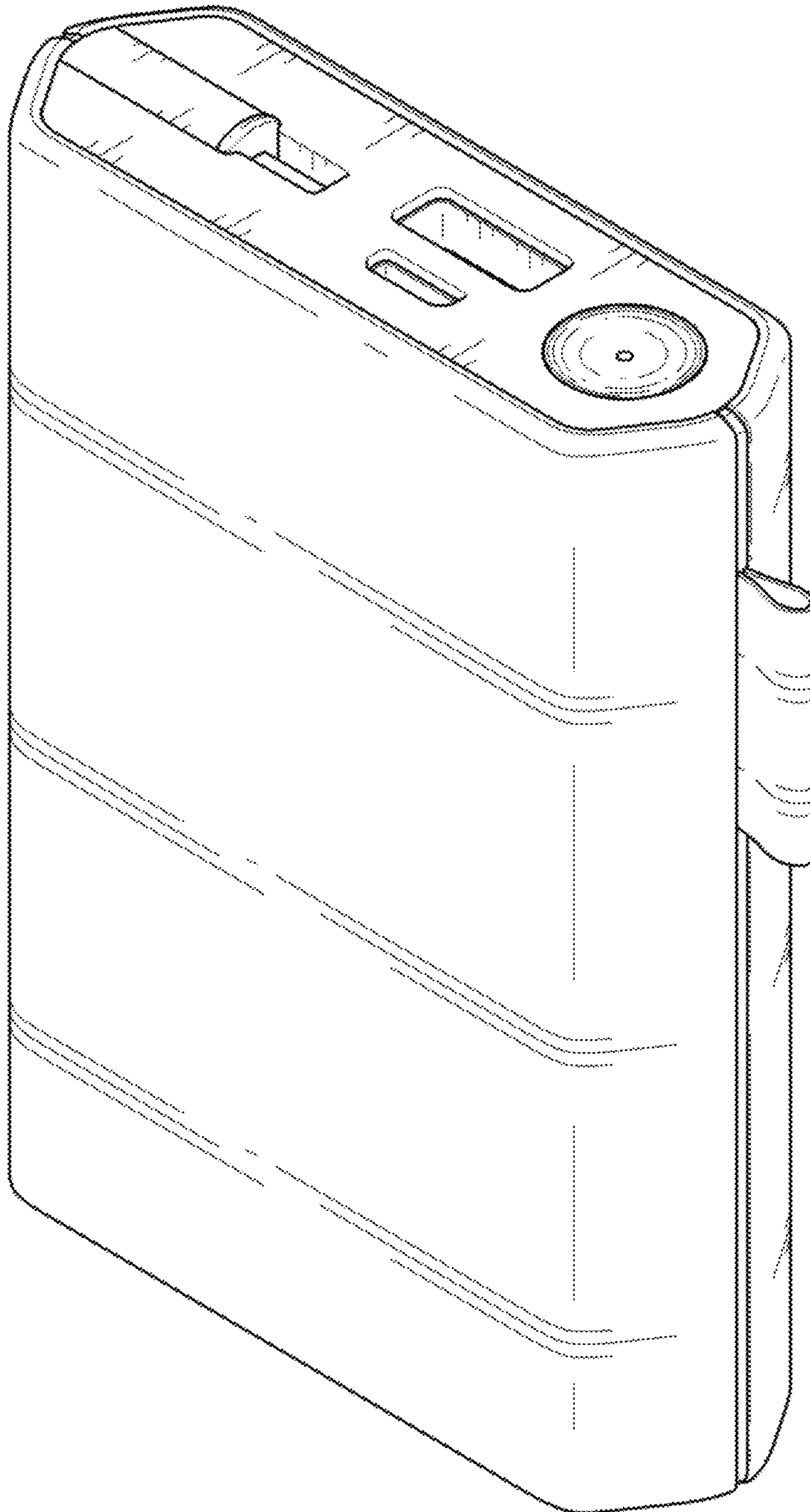

1.2

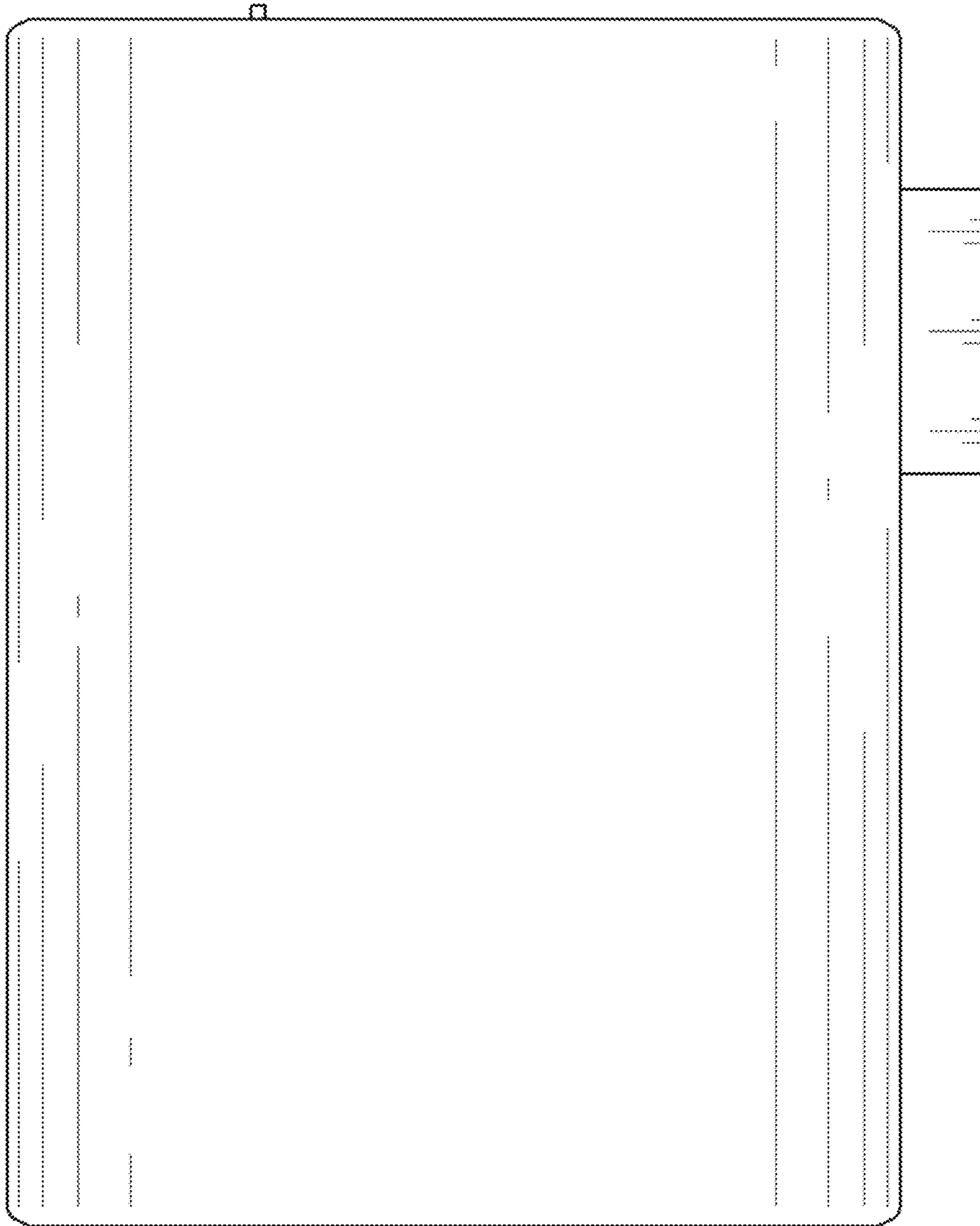

1.3

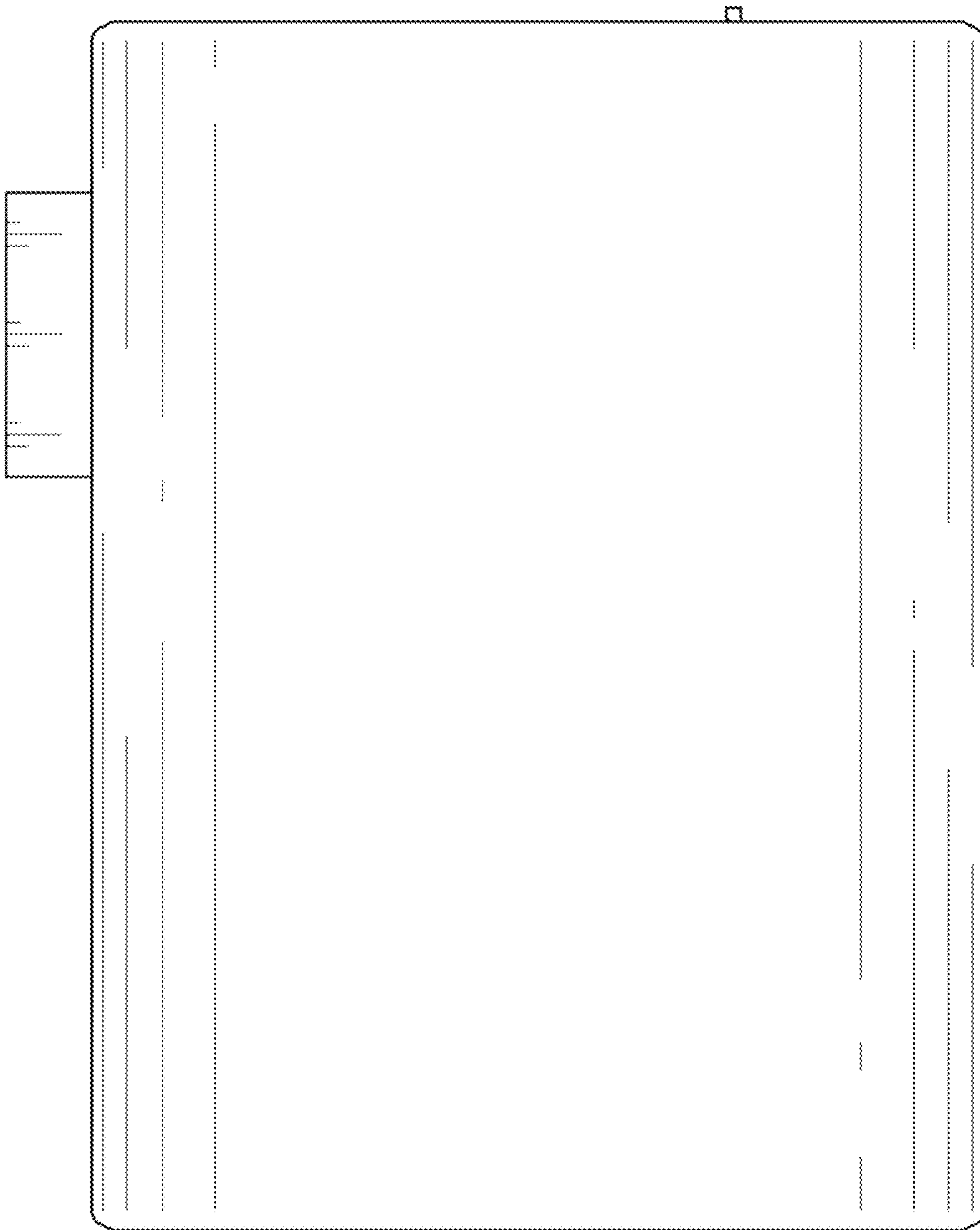

1.4

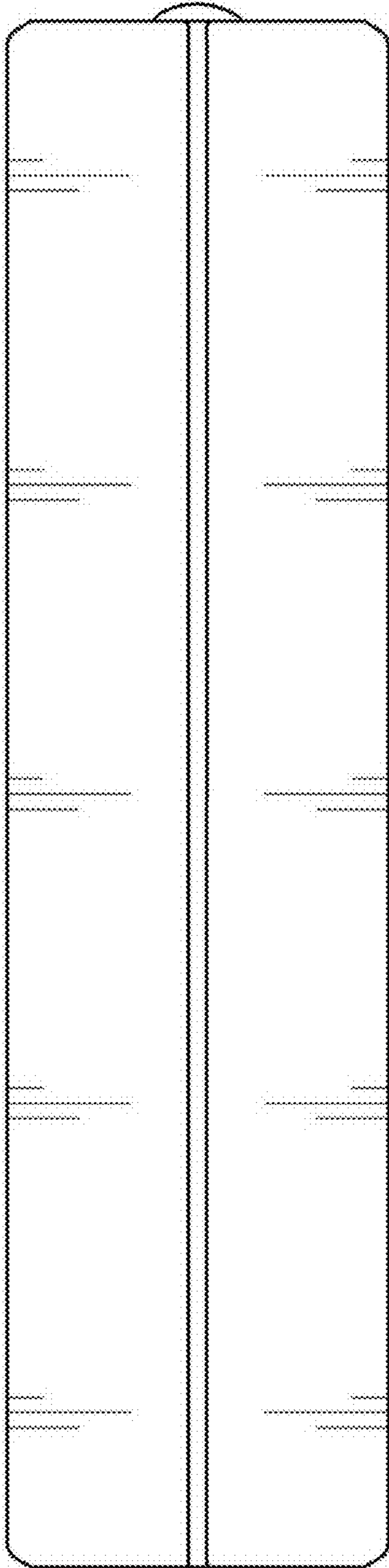

1.5

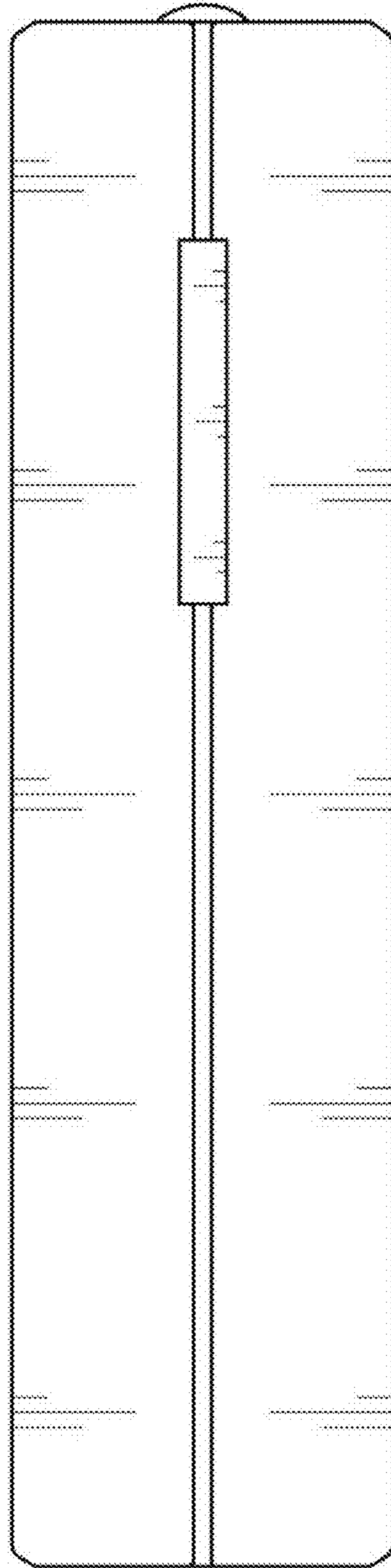

1.6

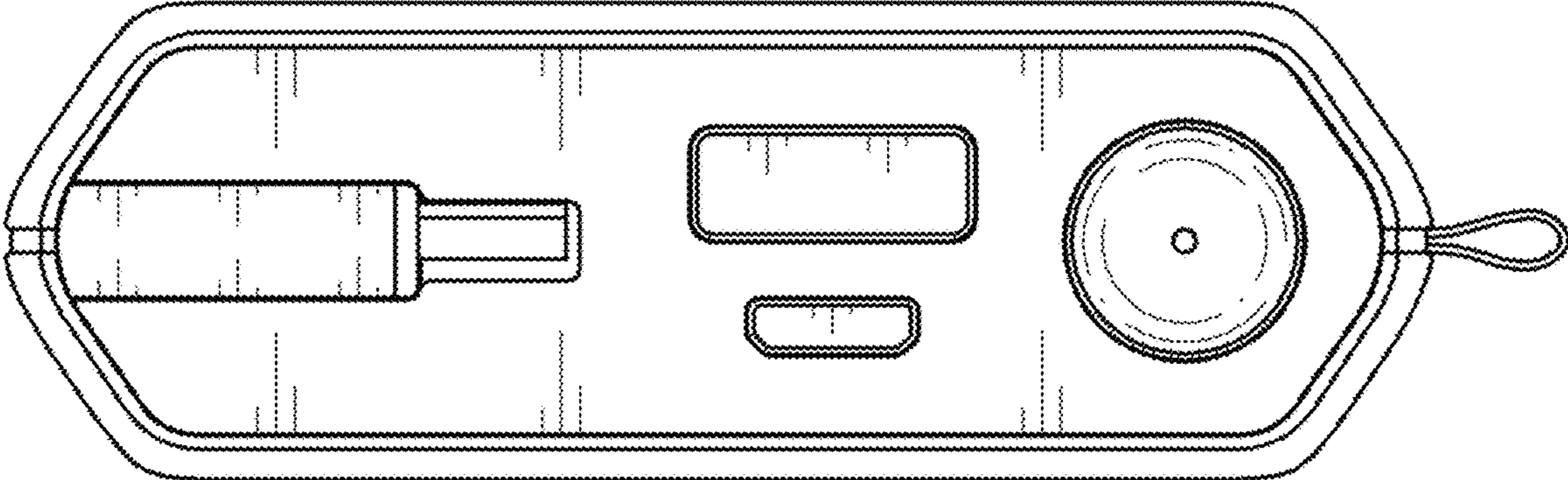

1.7

