



US00D824299S

(12) **United States Design Patent**  
**Stone et al.**

(10) **Patent No.:** **US D824,299 S**  
(45) **Date of Patent:** **\*\* Jul. 31, 2018**

(54) **VEHICLE FRONT BUMPER**

(71) Applicants: **Nicolas Ren Stone**, Royal Oak, MI (US); **Nicholas Vardis**, Sylvan Lake, MI (US)

(72) Inventors: **Nicolas Ren Stone**, Royal Oak, MI (US); **Nicholas Vardis**, Sylvan Lake, MI (US)

(73) Assignee: **FCA US LLC**, Auburn Hills, MI (US)

(\*\*) Term: **15 Years**

(21) Appl. No.: **29/594,152**

(22) Filed: **Feb. 16, 2017**

(51) **LOC (11) Cl.** ..... **12-16**

(52) **U.S. Cl.**  
USPC ..... **D12/169**

(58) **Field of Classification Search**  
USPC .... D12/169, 216, 90-92, 86, 171, 196, 163;  
293/102, 113, 115, 117, 120; 296/180.1,  
296/180.2  
CPC ..... B60R 19/02; B60R 19/04; B62D 25/08  
See application file for complete search history.

(56) **References Cited**

**U.S. PATENT DOCUMENTS**

D683,670 S \* 6/2013 Platto ..... D12/169  
D793,292 S \* 8/2017 Lee ..... D12/169

D793,293 S \* 8/2017 Lee ..... D12/169  
D798,202 S \* 9/2017 Zavatski ..... D12/169  
D802,498 S \* 11/2017 Zavatski ..... D12/169  
D811,290 S \* 2/2018 Ishii ..... D12/169

\* cited by examiner

*Primary Examiner* — Melody N Brown

(74) *Attorney, Agent, or Firm* — Ralph E. Smith

(57) **CLAIM**

The ornamental design for a vehicle front bumper, as shown and described.

**DESCRIPTION**

FIG. 1 is a front perspective view of a vehicle front bumper showing our new design; FIG. 2 is a left side view thereof; FIG. 3 is a right side view thereof; FIG. 4 is a front view thereof; FIG. 5 is a rear view thereof; FIG. 6 is a top view thereof; and, FIG. 7 is a bottom view thereof. It will be understood that the broken lines shown in the drawings illustrate portions of the vehicle front bumper that form no part of claimed design.

**1 Claim, 6 Drawing Sheets**

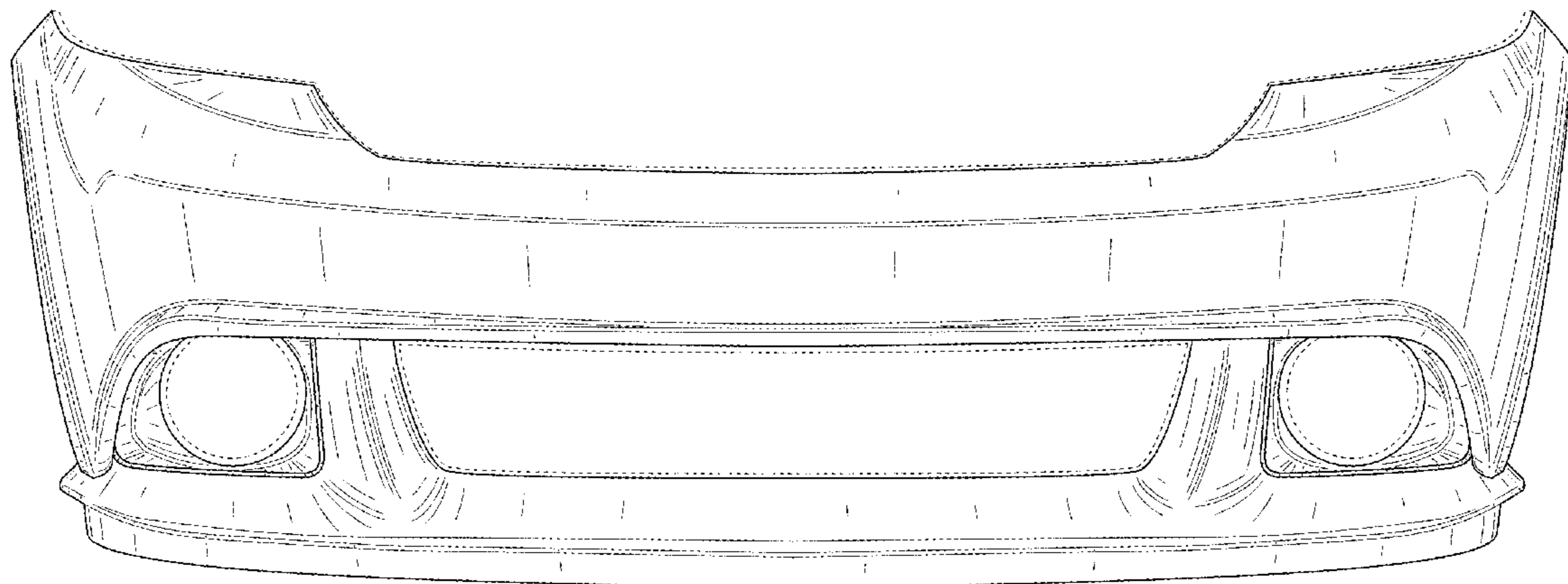

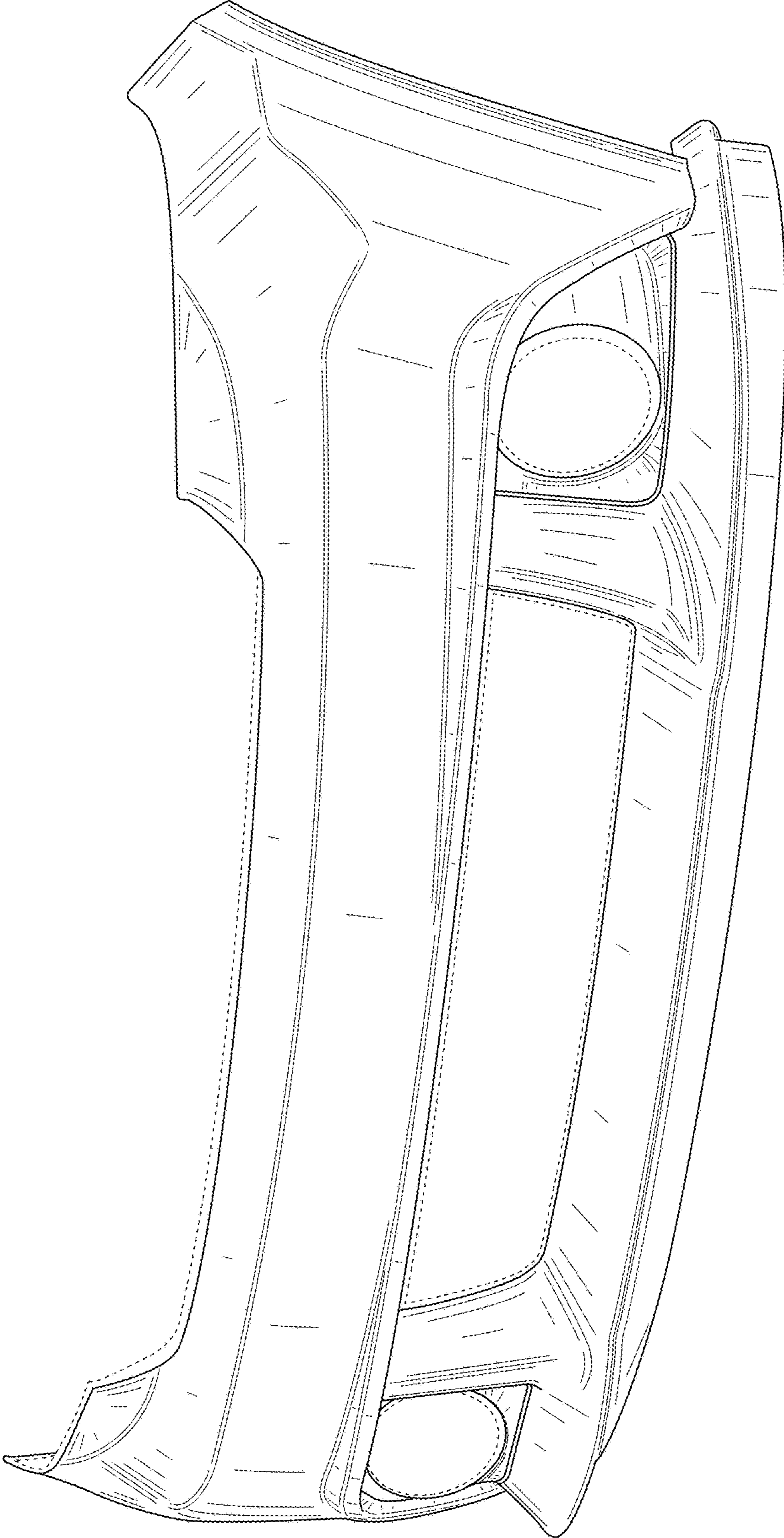
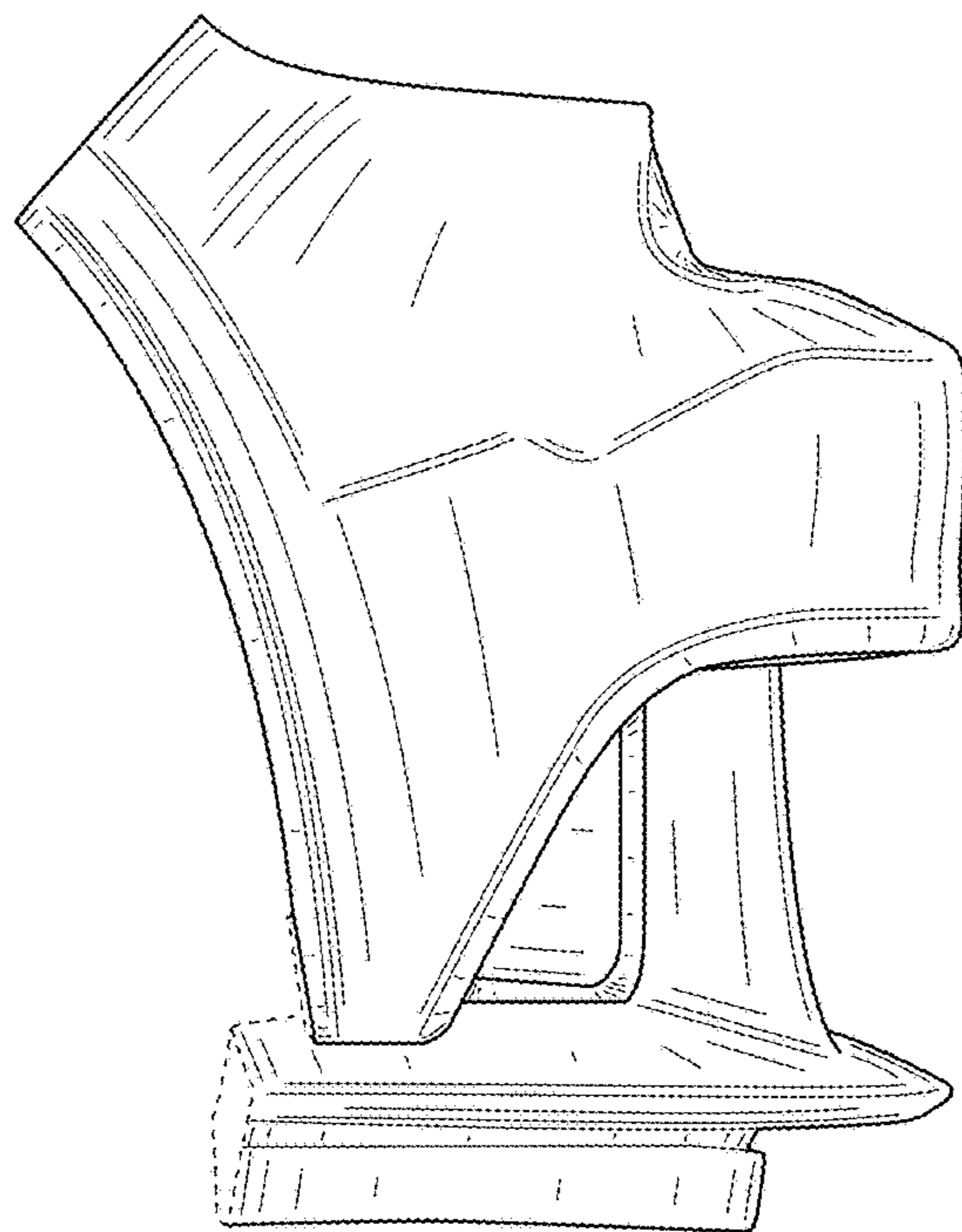
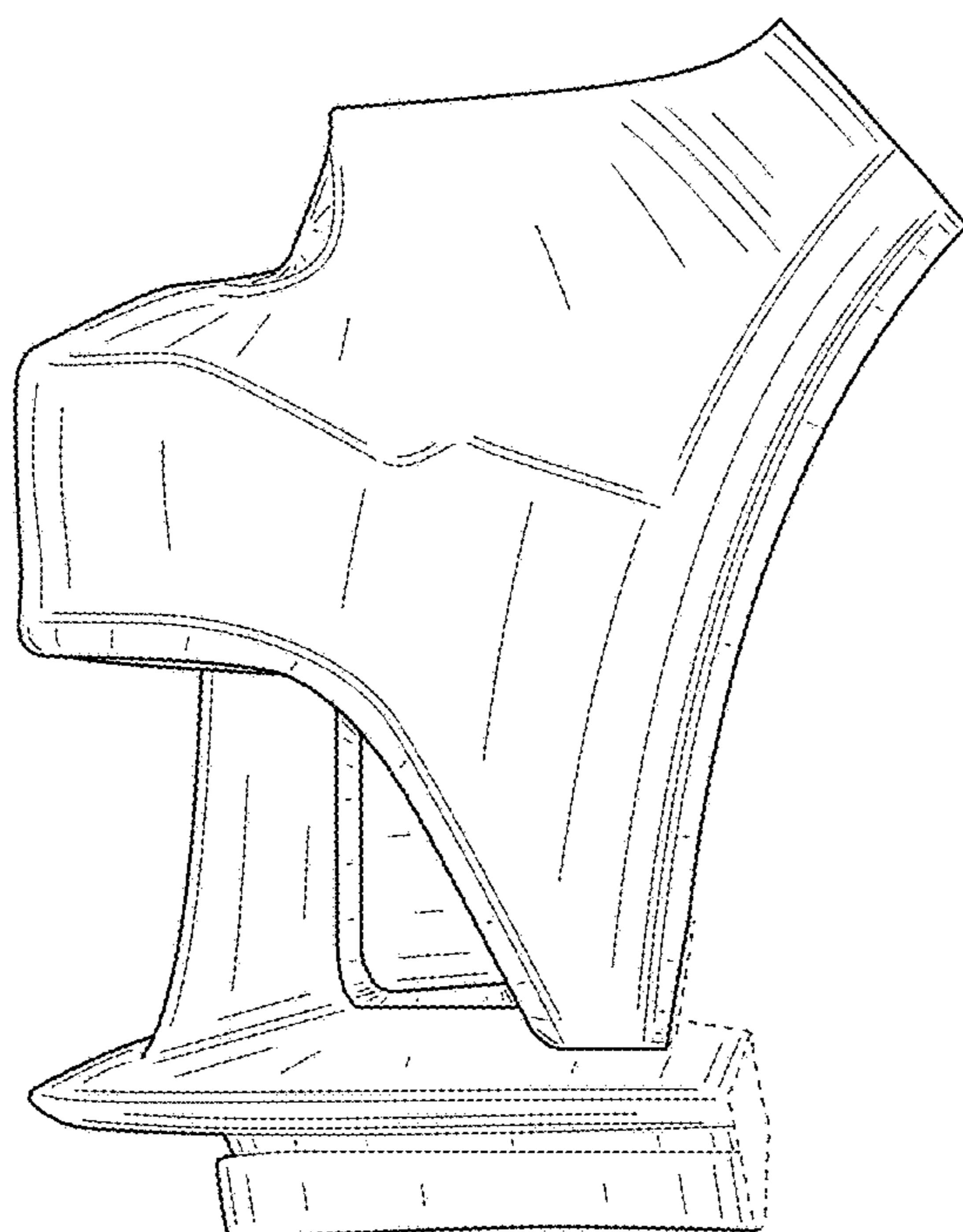

FIG. 1



**FIG. 2**



**FIG. 3**

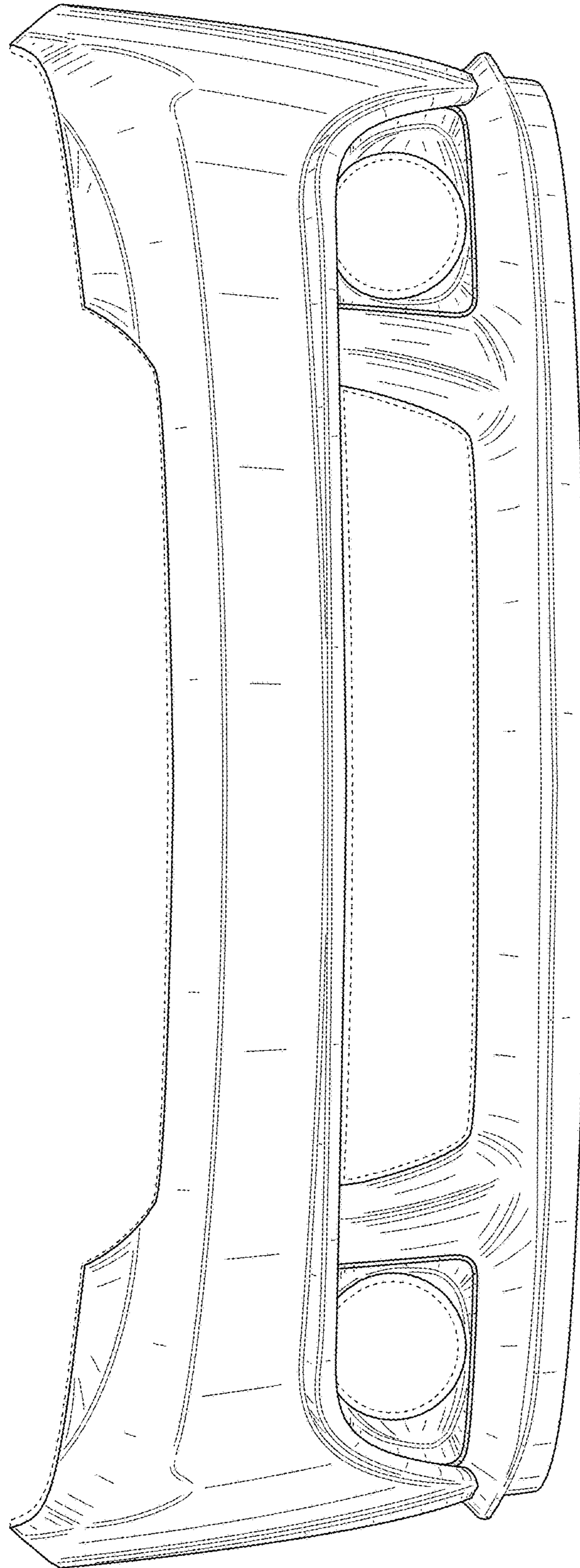

FIG. 4

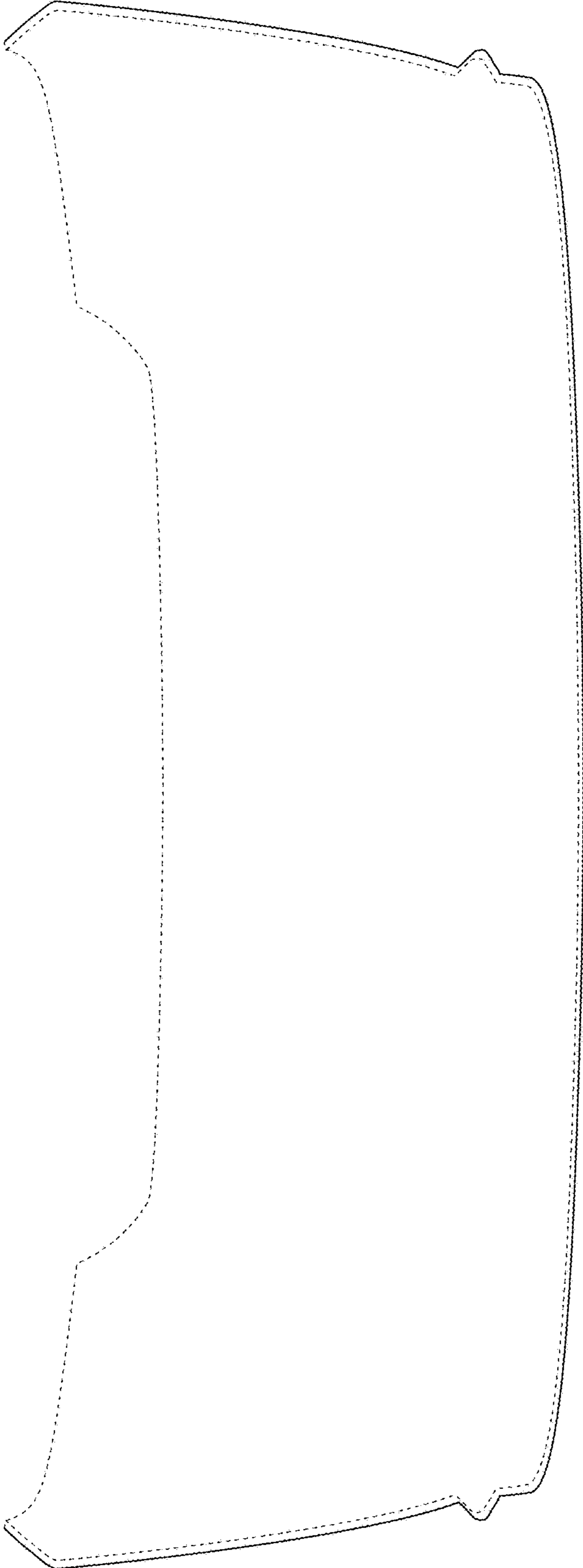

FIG. 5

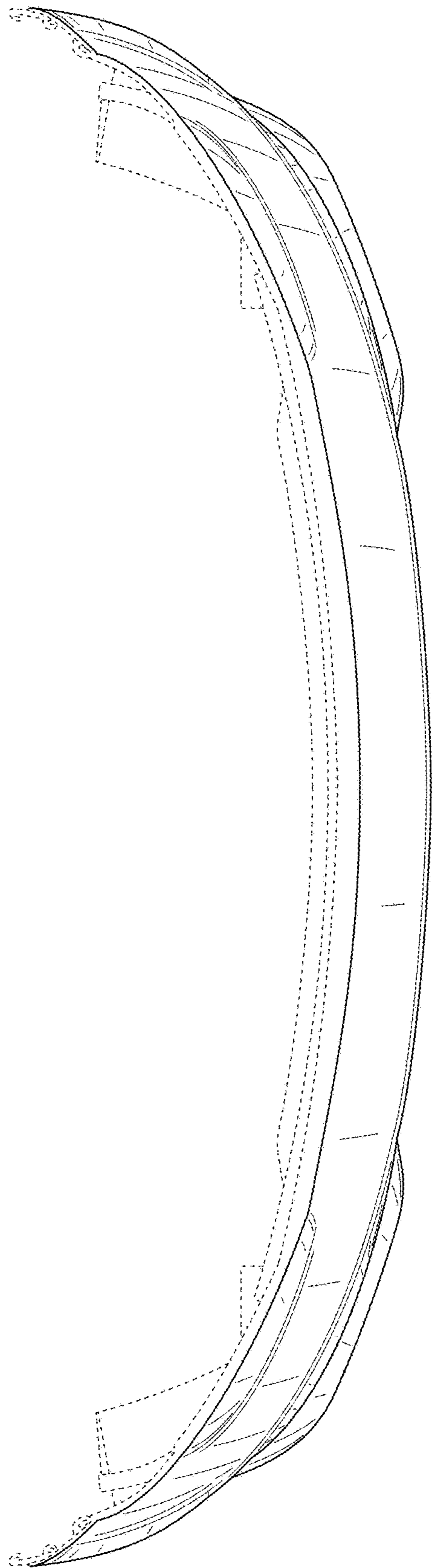

FIG. 6

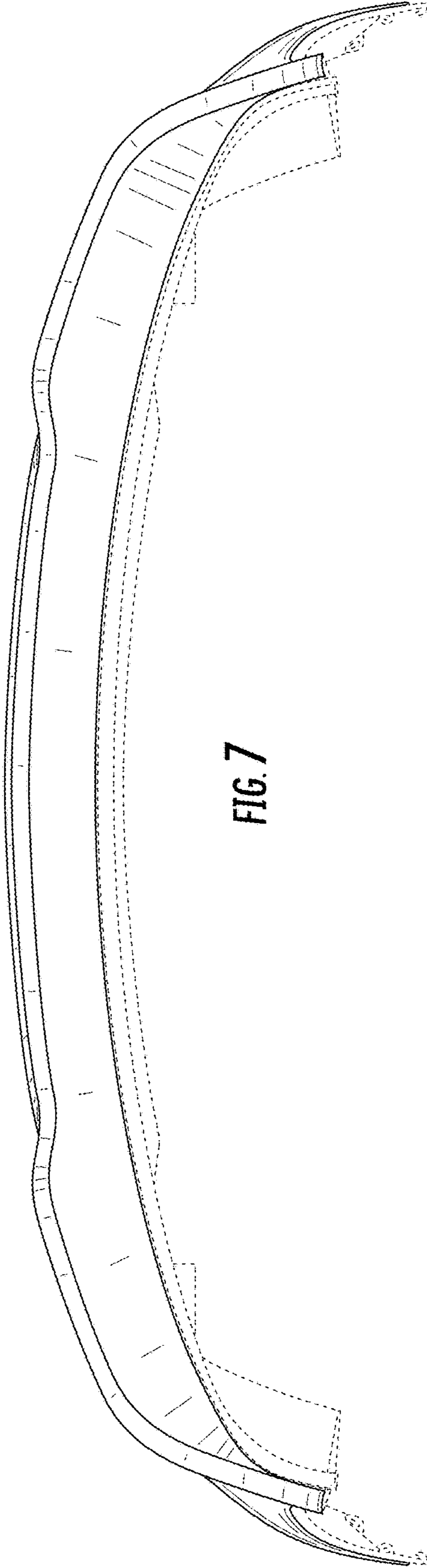

FIG. 7