



US00D824282S

(12) **United States Design Patent**
Woo et al.

(10) **Patent No.:** **US D824,282 S**
(45) **Date of Patent:** **** Jul. 31, 2018**

(54) **PLANT STAND**

(71) Applicant: **OMICISIS, INC.**, Daejeon (KR)
(72) Inventors: **Taeha Woo**, Sejong-si (KR); **Jungmin Seo**, Sejong-si (KR); **Seeun Kim**, Gongju-si (KR); **Sungho Kim**, Suwon-si (KR); **Sungrae Oh**, Daejeon (KR); **Sujung Kim**, Daejeon (KR)

(73) Assignee: **OMICISIS, INC.**, Daejeon (KR)

(**) Term: **15 Years**

(21) Appl. No.: **35/503,078**

(22) Filed: **Dec. 1, 2016**

(80) **Hague Agreement Data**

Int. Filing Date: **Dec. 1, 2016**
Int. Reg. No.: **DM/094190**
Int. Reg. Date: **Dec. 1, 2016**
Int. Reg. Pub. Date: **Jun. 2, 2017**

(30) **Foreign Application Priority Data**

Aug. 11, 2016 (KR) 30-2016-0039395

(51) **LOC (11) Cl.** **11-02**

(52) **U.S. Cl.**
USPC **D11/143**; D9/455

(58) **Field of Classification Search**
USPC D11/143-156, 164; D6/405, 556, 574, D6/403, 303, 306, 309, 312; D7/388, D7/389, 624.1, 624.2, 624.3, 625, 709, D7/601, 602, 605, 600, 708; D9/455, D9/715, 415, 656, 716, 433, 434, 432, D9/414, 420, 421, 425, 426, 430, 431, D9/655

CPC ... H01L 21/6734; A47F 7/0064; A47G 7/041; A47G 7/085; B65D 85/52; A01G 9/04; A01G 9/12; A01G 17/06; A47H 27/00

See application file for complete search history.

(56) **References Cited**

U.S. PATENT DOCUMENTS

4,940,199 A * 7/1990 Hall A47G 21/14
248/174
D360,827 S * 8/1995 Mats D9/711
D461,713 S * 8/2002 Foreman B65D 71/28
D9/434
D462,904 S * 9/2002 Mellon D9/434
7,591,496 B1 * 9/2009 De Beck A45C 7/0054
294/152
8,083,126 B2 * 12/2011 Fleming B65D 71/30
206/194

(Continued)

OTHER PUBLICATIONS

[Online] http://seedmo.omicscube.com/jp_product.html. Retrieved Apr. 16, 2018.*

Primary Examiner — Melanie Pellegrini
(74) *Attorney, Agent, or Firm* — Revolution IP, PLLC

(57) **CLAIM**

The ornamental design for a plant stand, as shown and described.

DESCRIPTION

1. Plant stand
1.1 : Perspective
1.2 : Front
1.3 : Back
1.4 : Top
1.5 : Bottom
1.6 : Left
1.7 : Right
1.8 : Reference showing use-status
1.9 : Reference showing use-status
The broken lines shown in the figures represent fold lines. The broken lines showing a pot in FIGS. **1.8** and **1.9** represent environment and form no part of the claimed design.

1 Claim, 9 Drawing Sheets

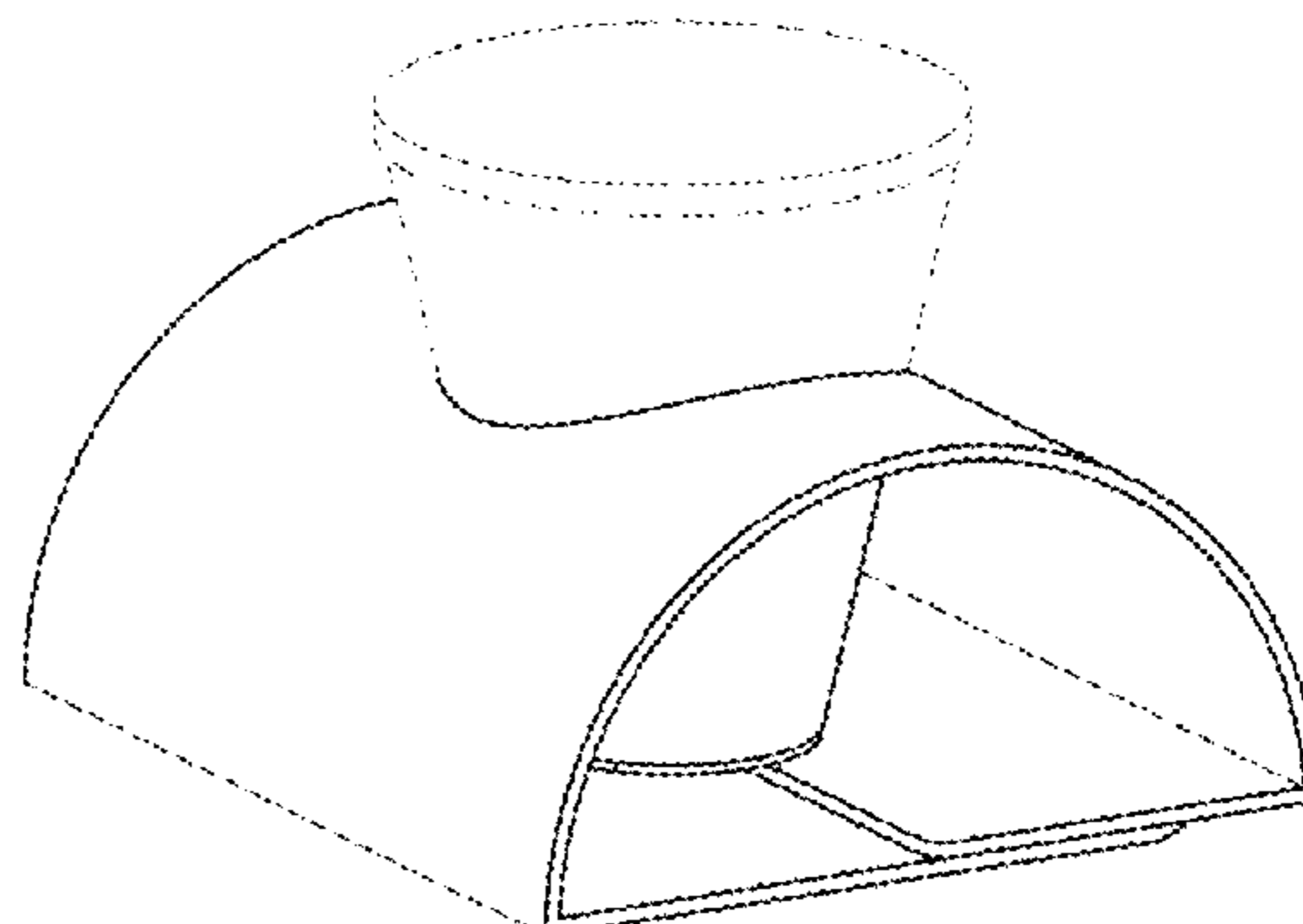
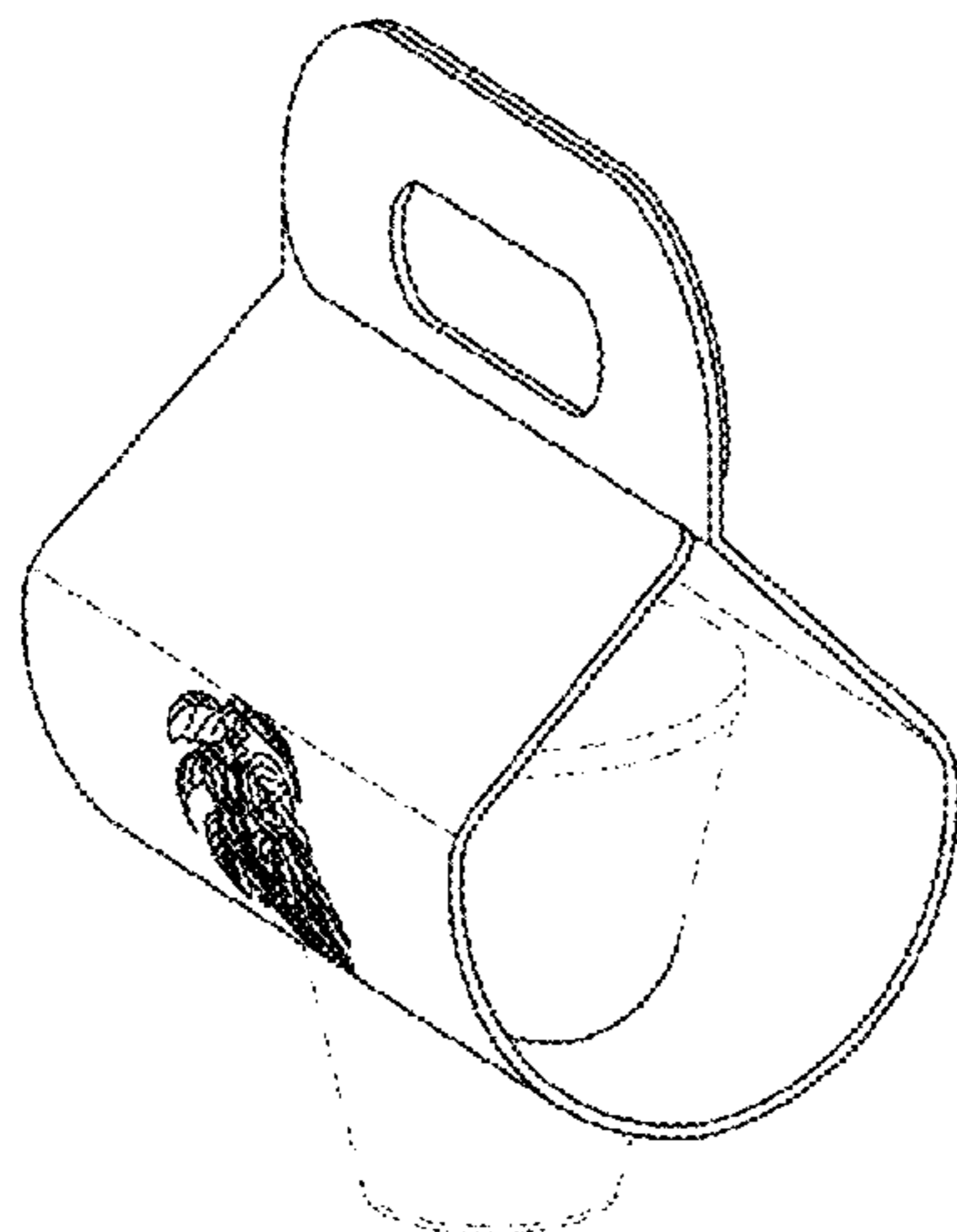

(56)

References Cited

U.S. PATENT DOCUMENTS

8,091,702 B1 * 1/2012 Keip A47G 23/0208
206/171
D654,810 S * 2/2012 Mansouri D9/711
D709,375 S * 7/2014 Smith D9/455
D714,639 S * 10/2014 Royer D9/433
D747,237 S * 1/2016 Nalgabatz D11/148
D764,874 S * 8/2016 Tarantino D7/601
D791,588 S * 7/2017 Rossbach D9/431
2005/0211578 A1 * 9/2005 Libit B65D 71/46
206/200
2008/0087558 A1 * 4/2008 Libit B65D 71/0074
206/196
2011/0272299 A1 * 11/2011 Smith B65D 71/48
206/175

* cited by examiner

1.1

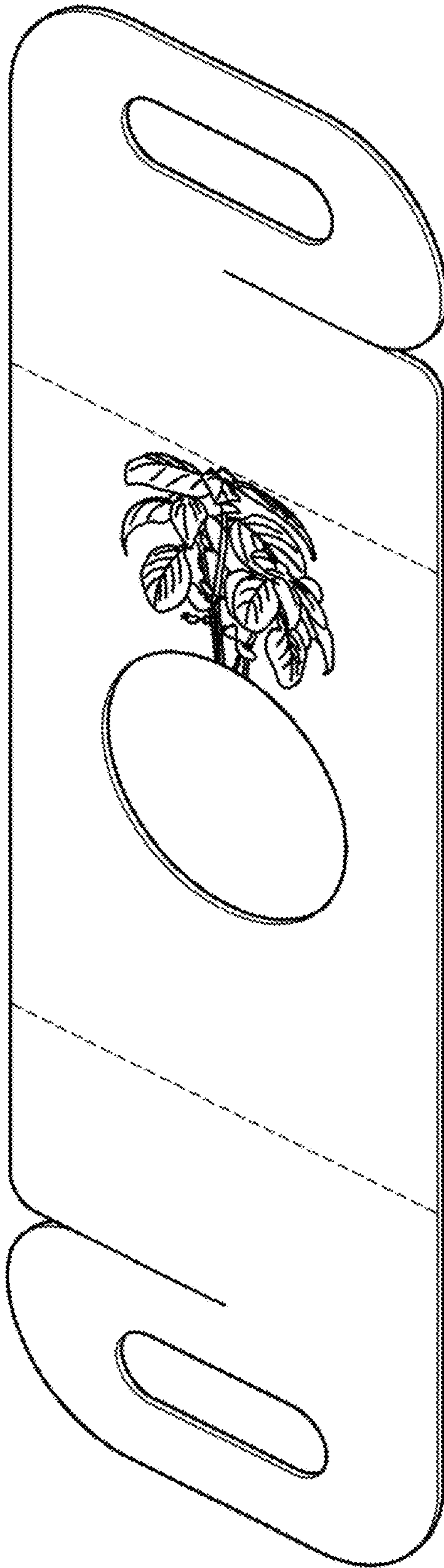

1.2

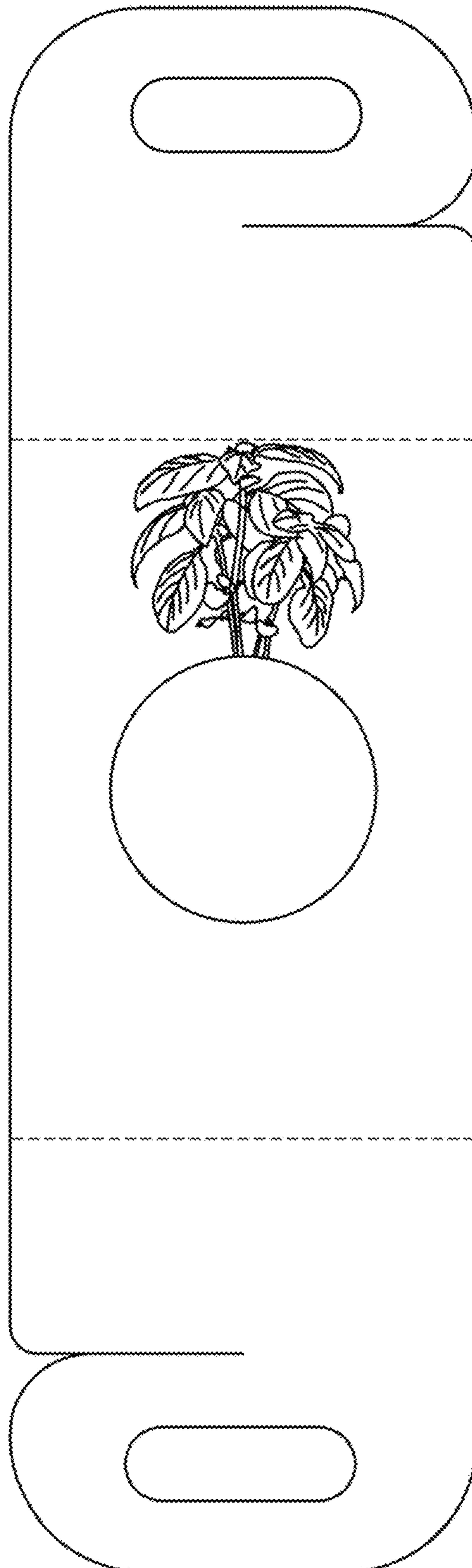

1.3

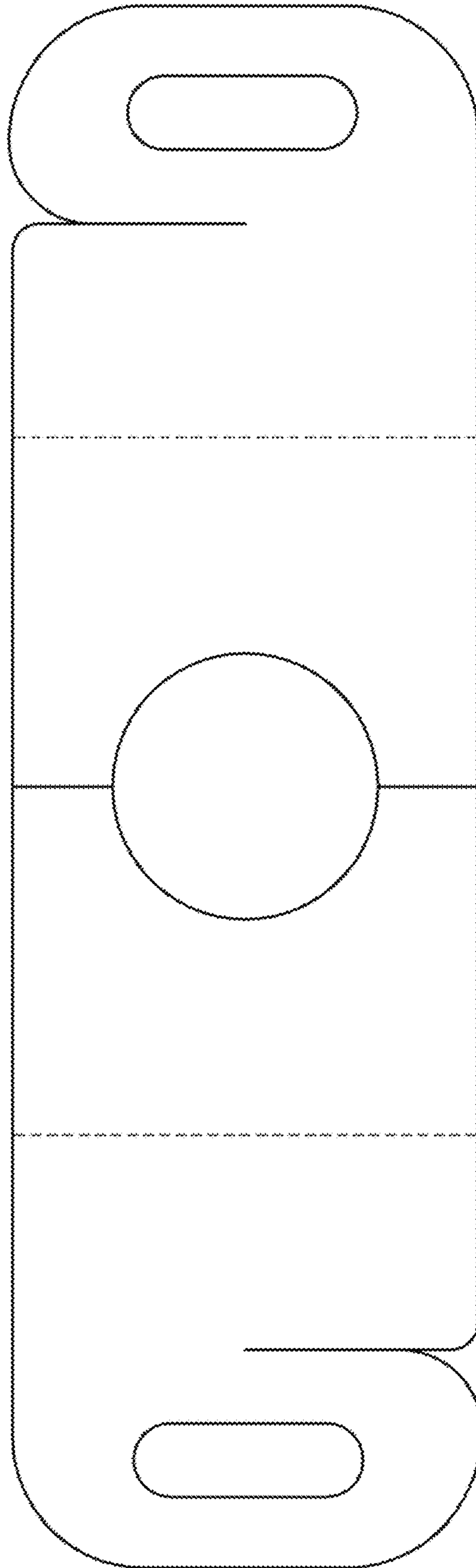

1.4

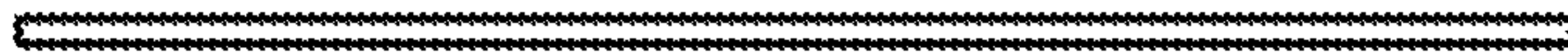

1.5



1.6



1.7



1.8

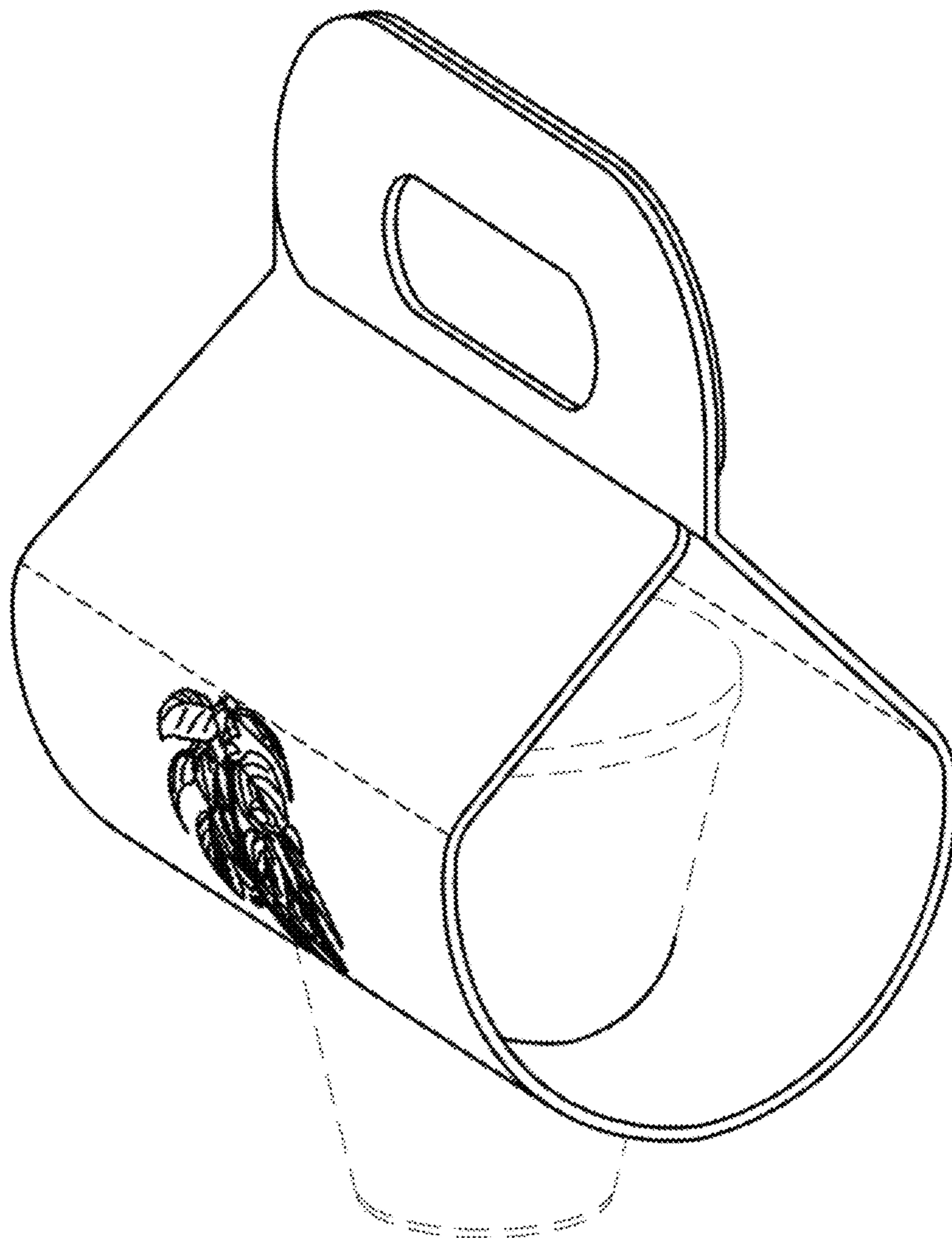

1.9

