



US00D824251S

(12) **United States Design Patent** (10) **Patent No.:** **US D824,251 S**
Torres et al. (45) **Date of Patent:** **** Jul. 31, 2018**

(54) **OVER THE COUNTER MEDICINE CONTAINER WITH SURFACE ORNAMENTATION**

Primary Examiner — Eric L Goodman
Assistant Examiner — Darcey E Hefflin
(74) *Attorney, Agent, or Firm* — Amanda Herman; Alexandra S. Anoff

(71) Applicant: **The Procter & Gamble Company**, Cincinnati, OH (US)

(57) **CLAIM**

(72) Inventors: **Andreina Eugenia Marcano Torres**, Mason, OH (US); **Susan Arnold**, Cincinnati, OH (US); **Amy Marie Kletz**, Cincinnati, OH (US); **Andrew Bernard Tesnar**, Newport, KY (US)

The ornamental design for an over the counter medicine container with surface ornamentation, as shown and described.

(73) Assignee: **The Procter & Gamble Company**, Cincinnati, OH (US)

DESCRIPTION

(**) Term: **15 Years**

The patent or application file contains at least one drawing executed in color. Copies of this patent or patent application publication with color drawing(s) will be provided by the Office upon request and payment of the necessary fee.

(21) Appl. No.: **29/595,371**

FIG. 1 is a perspective view of an over the counter medicine container with surface ornamentation embodying our new design;

(22) Filed: **Feb. 28, 2017**

FIG. 2 is a front view thereof;

(51) **LOC (11) Cl.** **09-03**

FIG. 3 is a left side view thereof;

(52) **U.S. Cl.**

FIG. 4 is rear view thereof;

USPC **D9/430**

FIG. 5 is a right side view thereof;

(58) **Field of Classification Search**

USPC D9/434, 435, 499, 414, 423, 424, 600,

FIG. 6 is a top view thereof;

D9/667, 425, 428, 430, 432, 433, 451,

FIG. 7 is a bottom view thereof;

(Continued)

FIG. 8 is a perspective view of a second embodiment of an over the counter medicine container with surface ornamentation embodying our new design;

(56) **References Cited**

FIG. 9 is a front view thereof;

U.S. PATENT DOCUMENTS

FIG. 10 is a left side view thereof;

D637,486 S * 5/2011 Andrew D5/7

FIG. 11 is a rear view thereof;

D638,703 S * 5/2011 Sovonick D9/434

FIG. 12 is a right side view thereof;

(Continued)

FIG. 13 is a top view thereof;

OTHER PUBLICATIONS

Amazon. Vicks Formula 44 Custom Care Dry Cough Berry Burst Flavor Liquid. Oct. 10, 2011 [earliest online date], [site visited Dec. 6, 2017]. Available from Internet, <URL:https://www.amazon.com/Vicks-Formula-Custom-Flavor-Liquid/dp/B00371NU0G>. (Year: 2011).*

FIG. 14 is a bottom view thereof;

FIG. 15 is a perspective view of a third embodiment of an over the counter medicine container with surface ornamentation embodying our new design;

FIG. 16 is a front view thereof;

FIG. 17 is a left side view thereof;

FIG. 18 is a rear view thereof;

FIG. 19 is a right side view thereof;

FIG. 20 is a top view thereof;

(Continued)

(Continued)

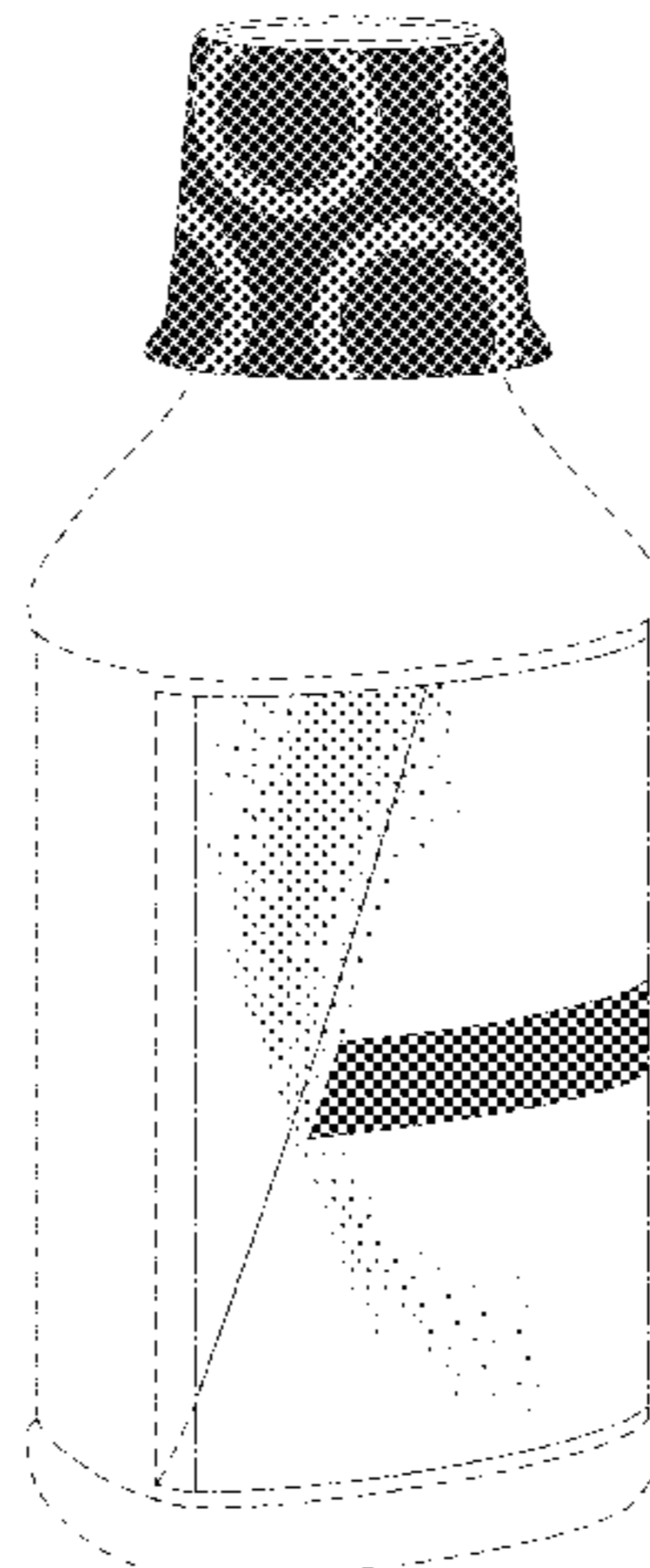

FIG. 21 is a bottom view thereof;
 FIG. 22 is a perspective view of a fourth embodiment of an over the counter medicine container with surface ornamentation embodying our new design;
 FIG. 23 is a front view thereof;
 FIG. 24 is a left side view thereof;
 FIG. 25 is a rear view thereof;
 FIG. 26 is a right side view thereof;
 FIG. 27 is a top view thereof;
 FIG. 28 is a bottom view thereof;
 FIG. 29 is a perspective view of a fifth embodiment of an over the counter medicine container with surface ornamentation embodying our new design;
 FIG. 30 is a front view thereof;
 FIG. 31 is a left side view thereof;
 FIG. 32 is a rear view thereof;
 FIG. 33 is a right side view thereof;
 FIG. 34 is a top view thereof; and,
 FIG. 35 is a bottom view thereof.
 In the drawings, the evenly-spaced broken lines showing portions of a medicine container depict environment and form no part of the claim; the dash-dot-dah lines represent boundaries of the claimed design and form no part thereof.

**1 Claim, 20 Drawing Sheets
 (16 of 20 Drawing Sheet(s) Filed in Color)**

(58) **Field of Classification Search**
 USPC D9/452, 457, 614, 703, 516; D5/56, 59,
 D5/60, 62; D14/485, 489-492, 495;
 D20/22, 31, 32

CPC B65D 5/4233; B65D 2203/00; B65D
 2203/02; G09F 3/02; G09F 2003/0272;
 G09F 2003/0273
 See application file for complete search history.

(56) **References Cited**

U.S. PATENT DOCUMENTS

D646,970	S	*	10/2011	Sovonick	D9/434
D647,796	S	*	11/2011	Sovonick	D9/434
D647,797	S	*	11/2011	Sovonick	D9/434
D649,044	S	*	11/2011	Sovonick	D9/434
D649,877	S	*	12/2011	Sovonick	D9/434
D675,089	S	*	1/2013	Cook	D9/428
D684,467	S	*	6/2013	Macaulay	D9/432
D691,470	S	*	10/2013	Macaulay	D9/434
D703,533	S	*	4/2014	Merchant	D9/434
D707,122	S	*	6/2014	Merchant	D9/434
D710,687	S	*	8/2014	Katopo	D9/432
D715,140	S	*	10/2014	Markle et al.	D9/434
D736,620	S	*	8/2015	Markle	D9/516
D744,334	S	*	12/2015	Merchant	D9/434
D745,394	S	*	12/2015	Hood	D9/432
D747,203	S	*	1/2016	Merchant	D9/516
D751,906	S	*	3/2016	Boston	D9/499
D763,692	S	*	8/2016	Forsberg	20/27
D779,327	S	*	2/2017	Fraser	D9/499
D786,680	S	*	5/2017	Merchant	D9/516
D799,964	S	*	10/2017	Abel	D9/499

OTHER PUBLICATIONS

Walgreens. Vicks 44 DM Cough Liquid Berry, Berry Flavor. Aug. 2017 [earliest online date], [site visited Dec. 6, 2017]. Available from Internet, <URL:https://www.walgreens.com/store/c/vicks-44-dm-cough-liquid-berry/ID=prod6360059-product?reactjs=true>. (Year: 2017).*

* cited by examiner

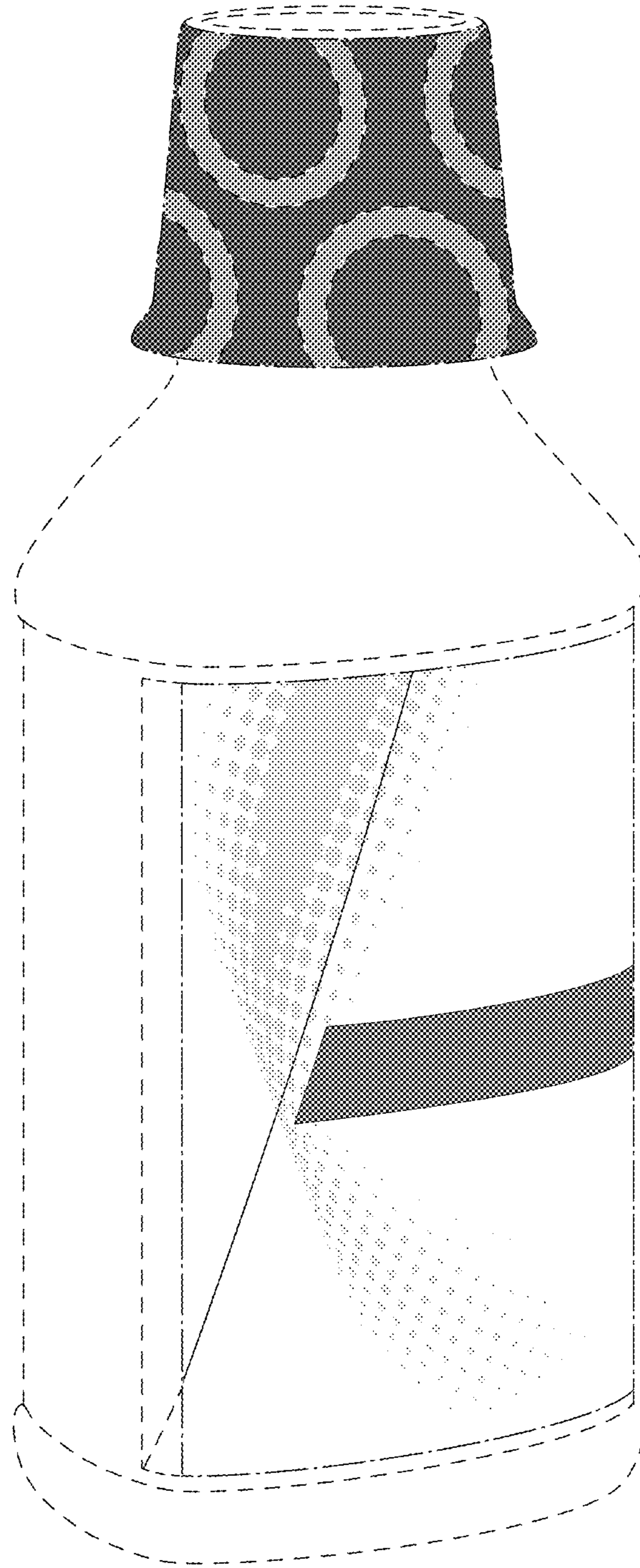

FIG. 1

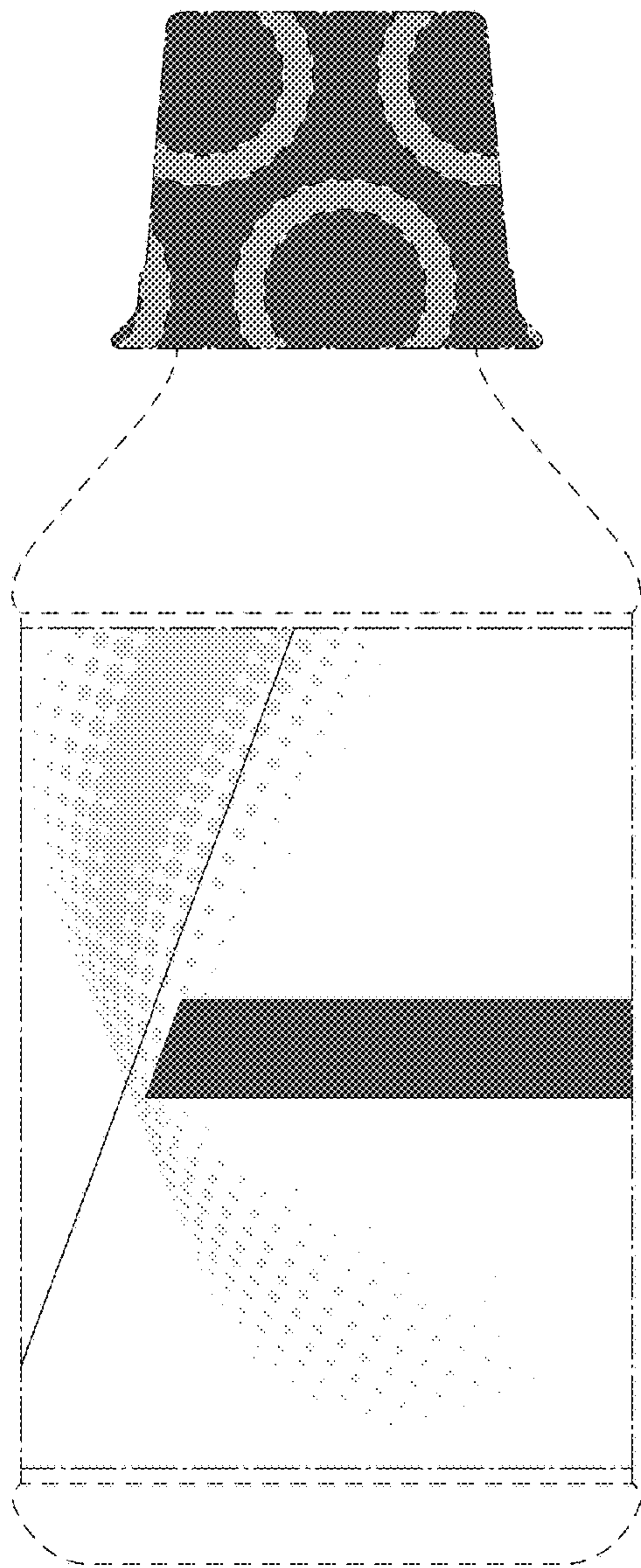

FIG. 2

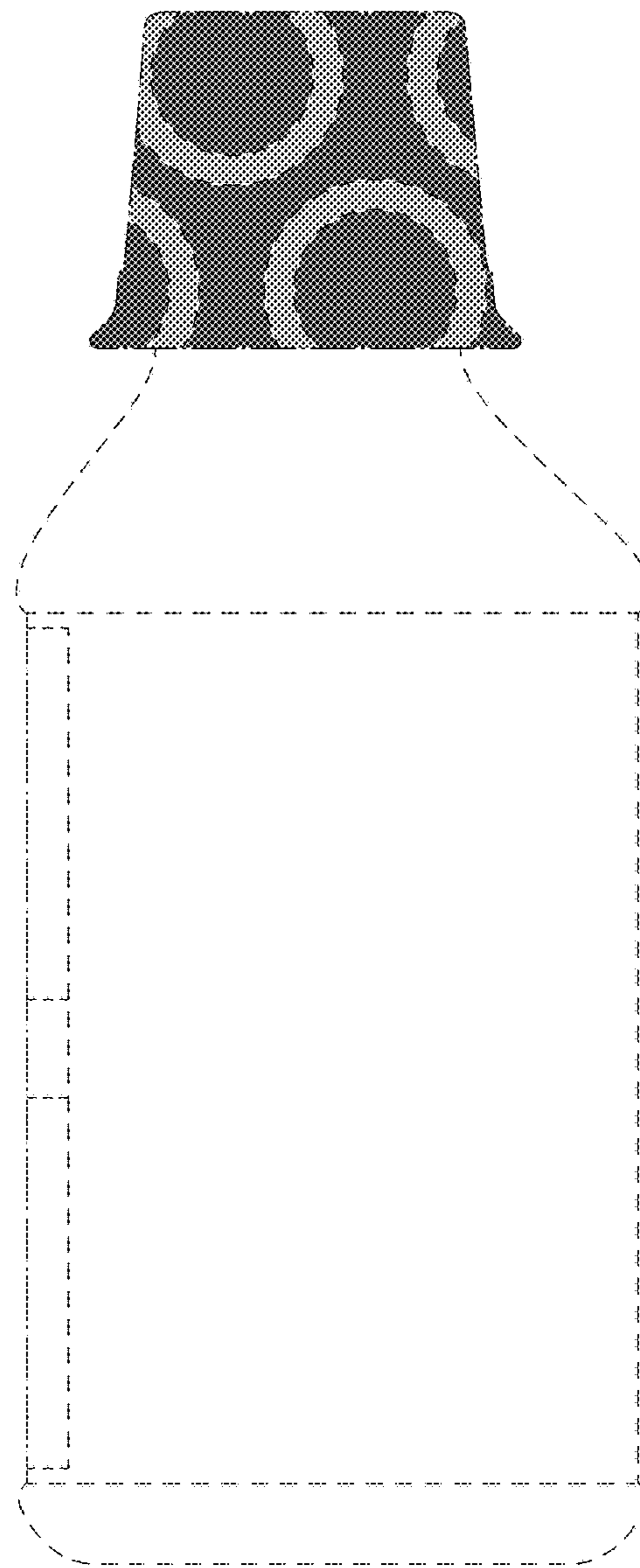

FIG. 3

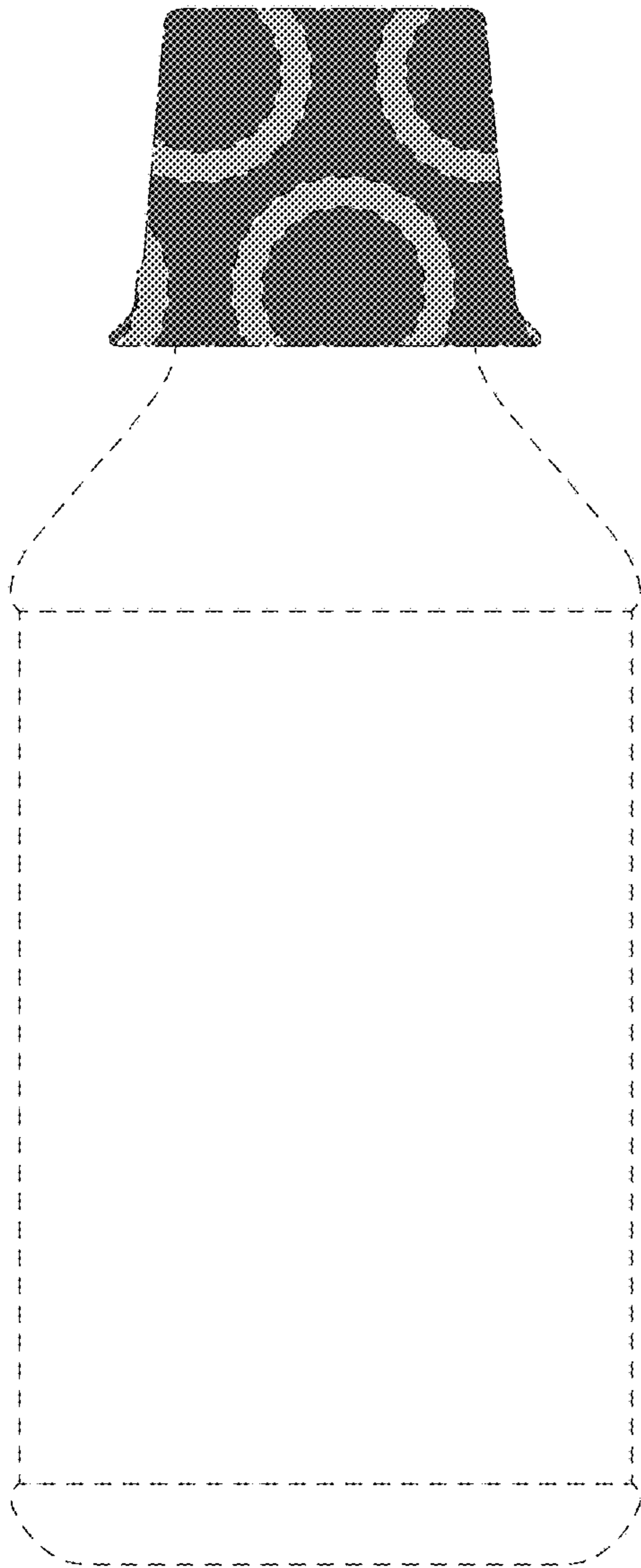

FIG. 4

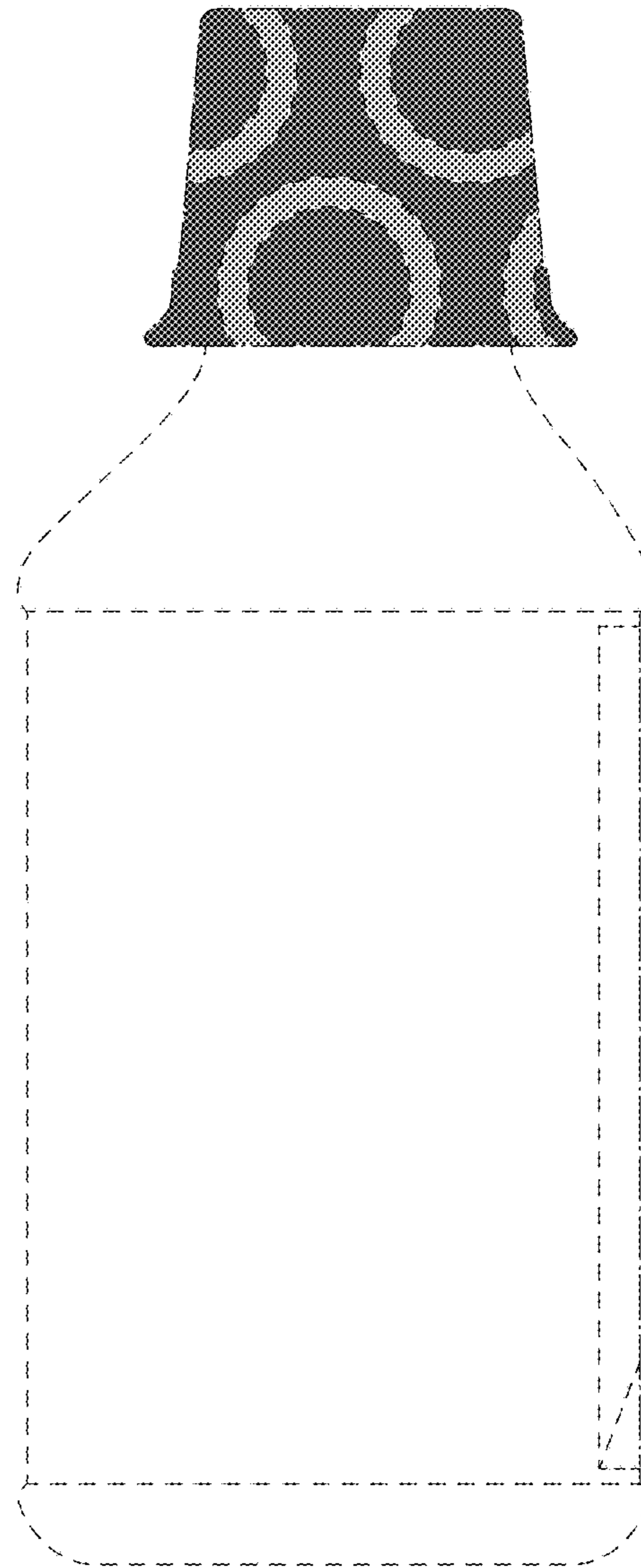

FIG. 5

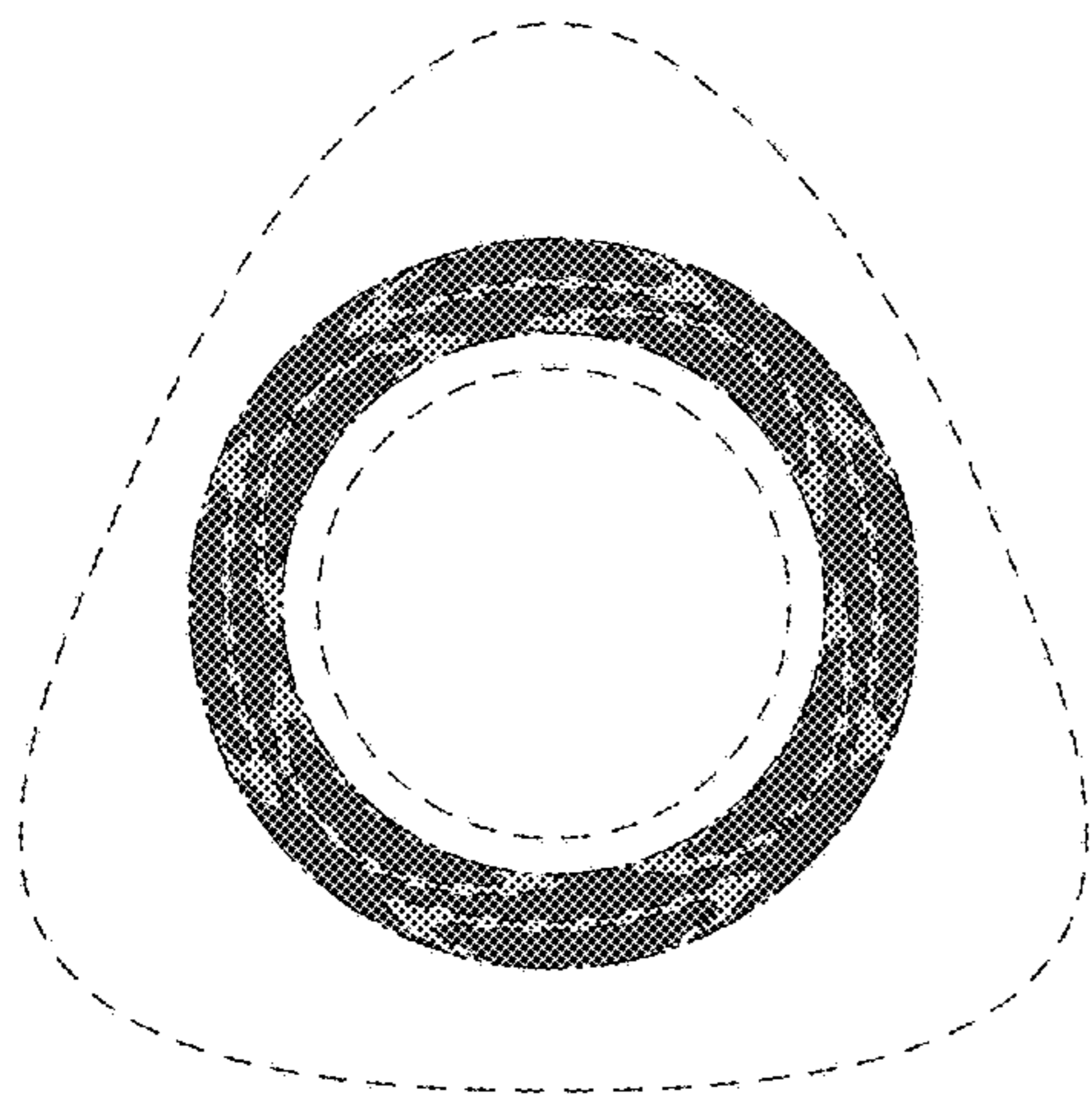

FIG. 6

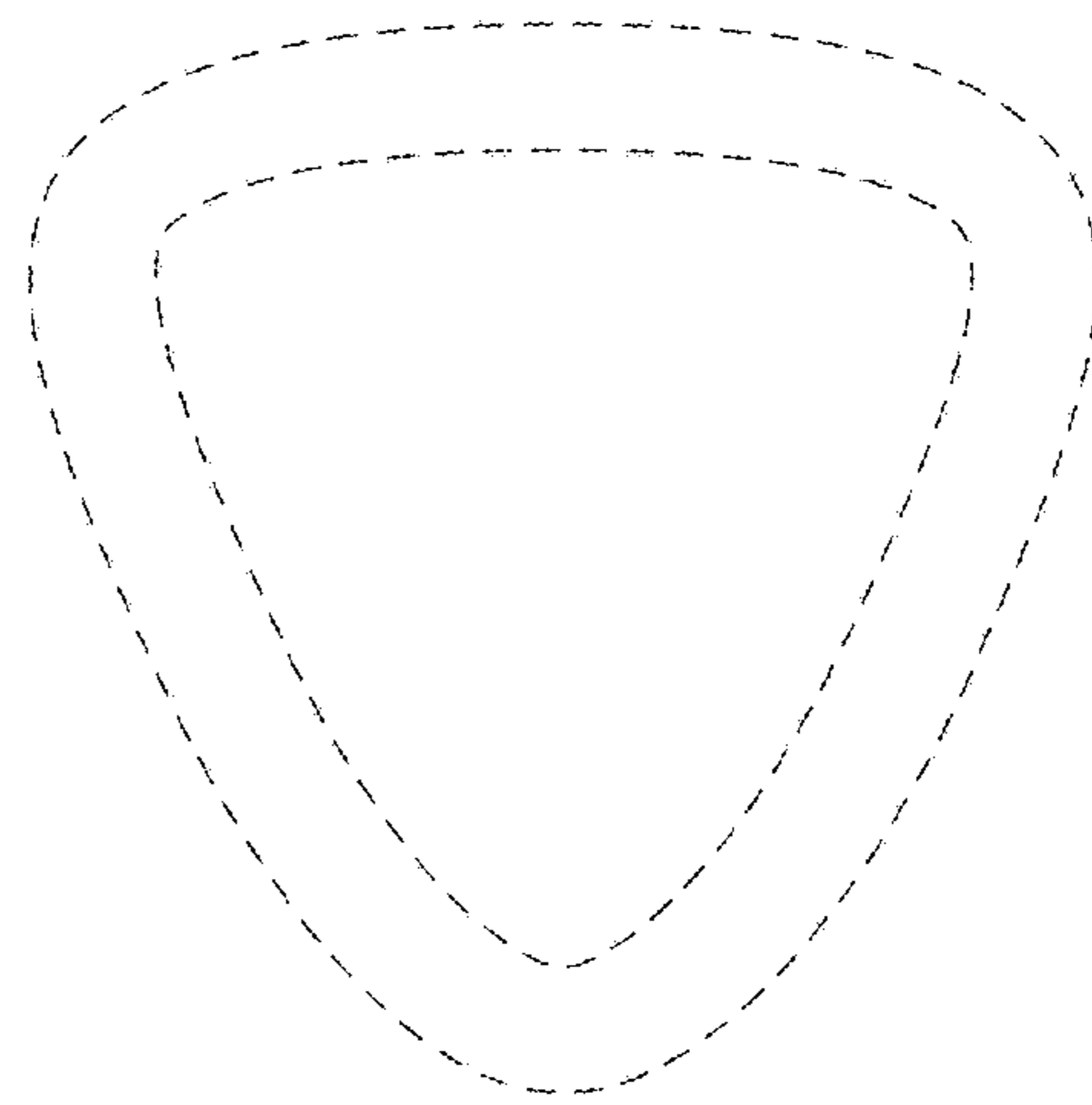

FIG. 7

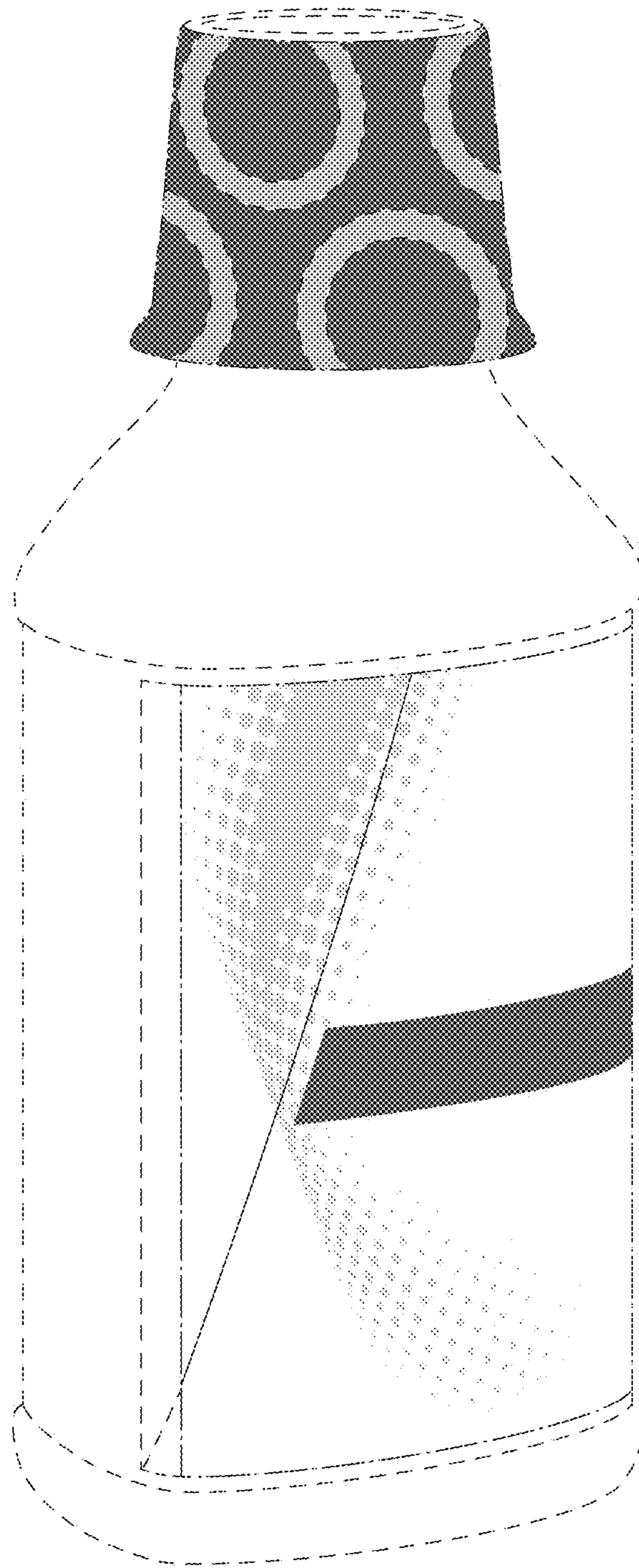

FIG. 8

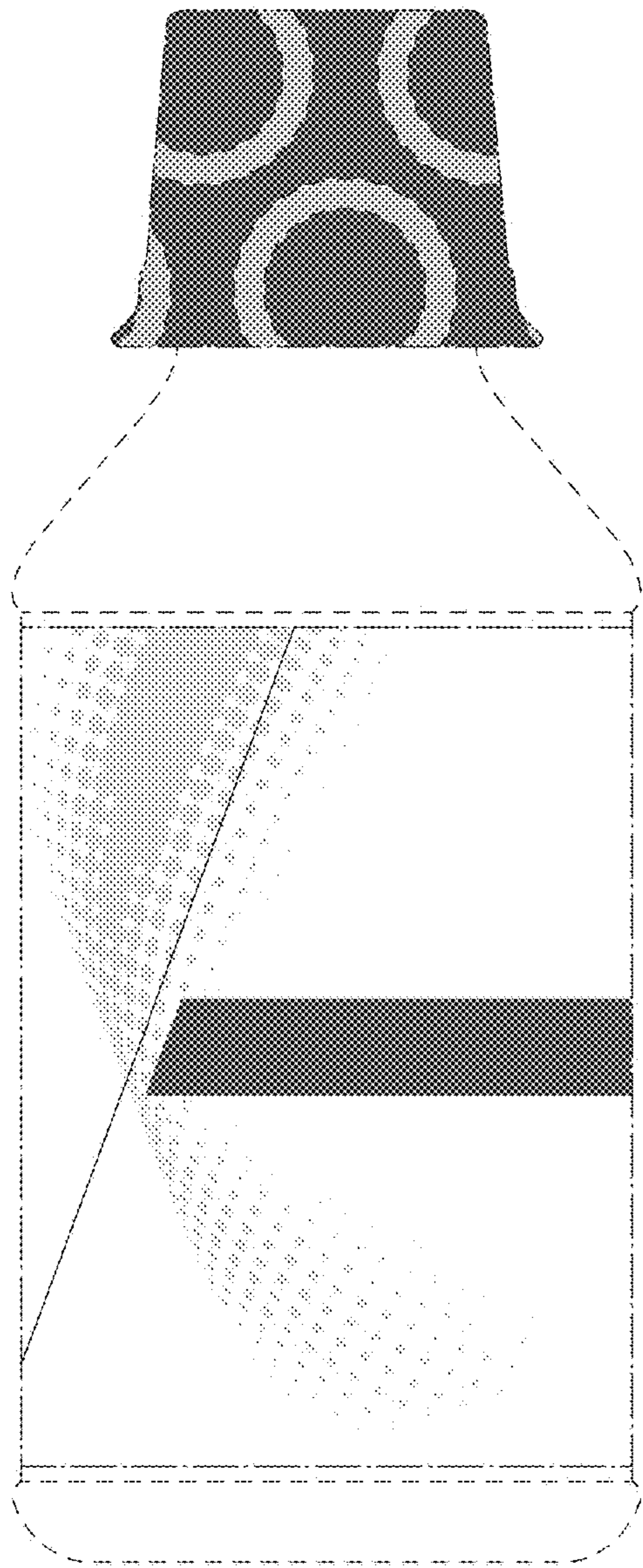

FIG. 9

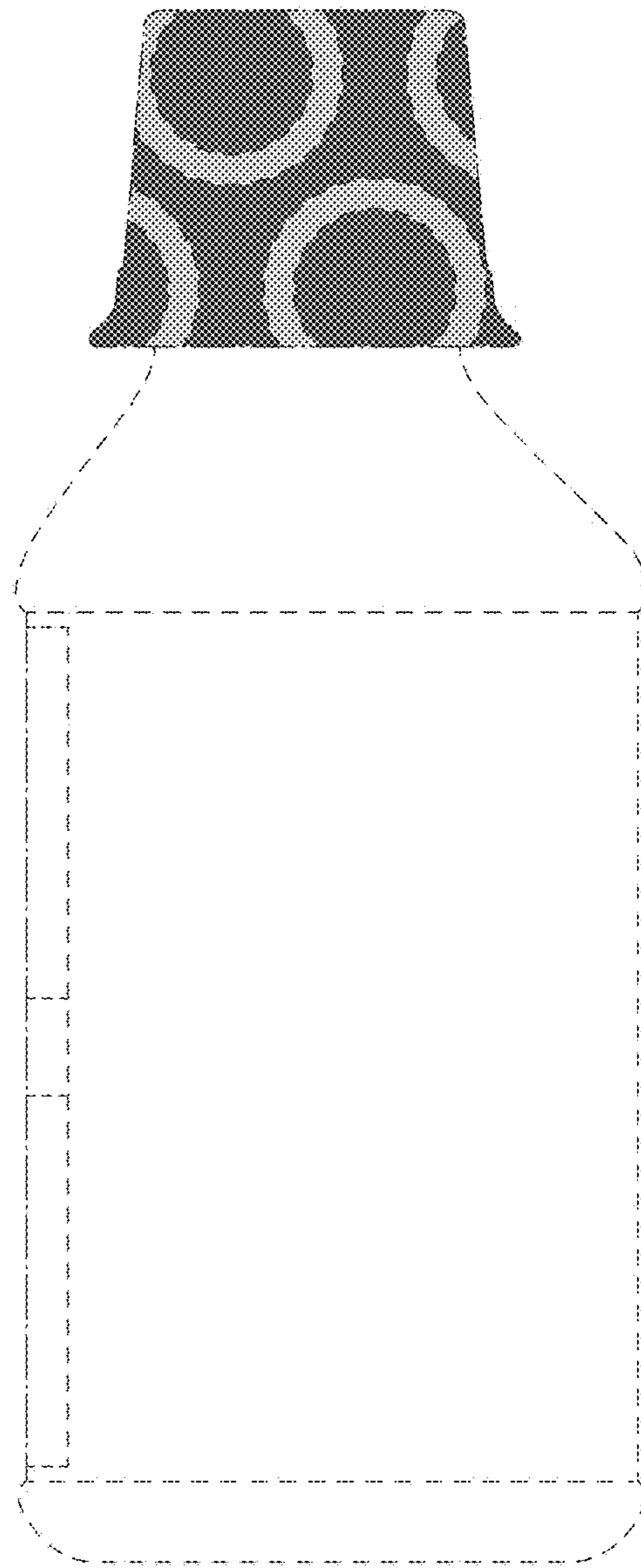

FIG. 10

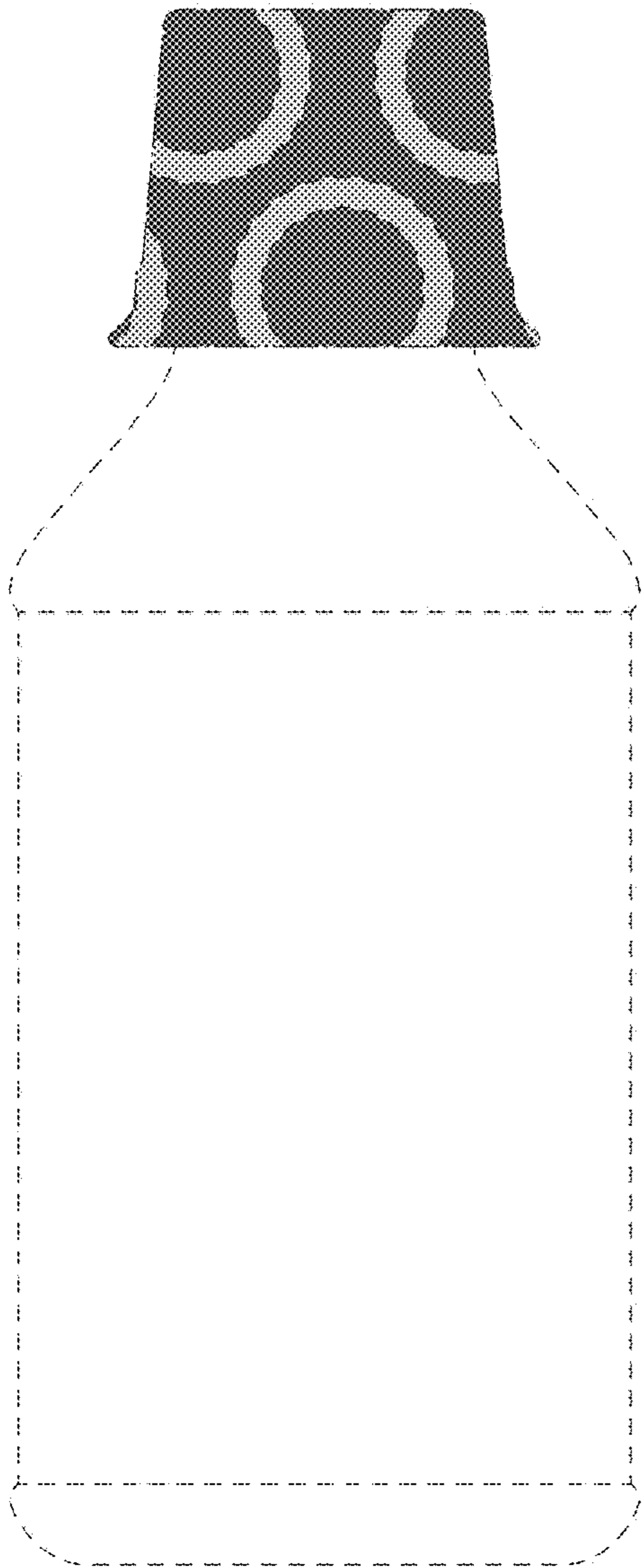

FIG. 11

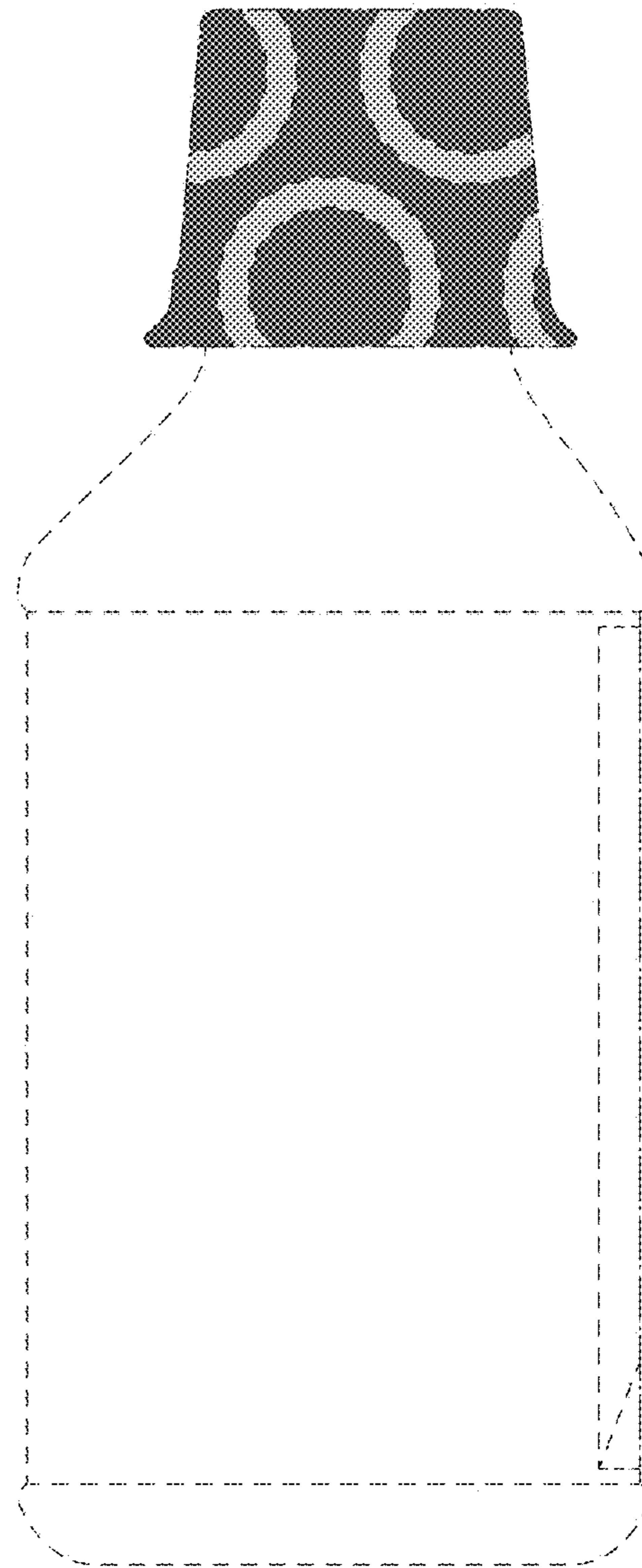

FIG. 12

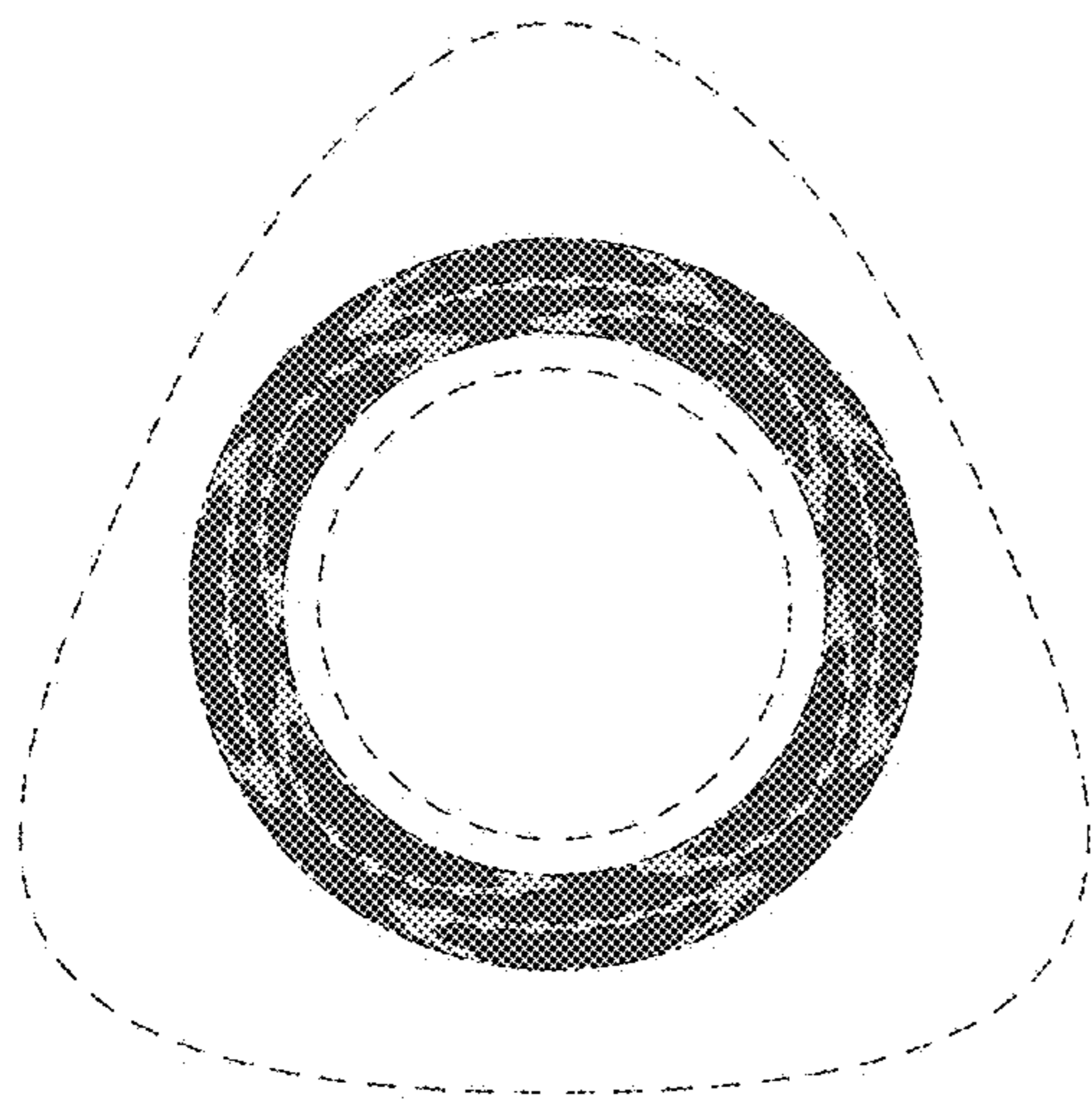

FIG. 13

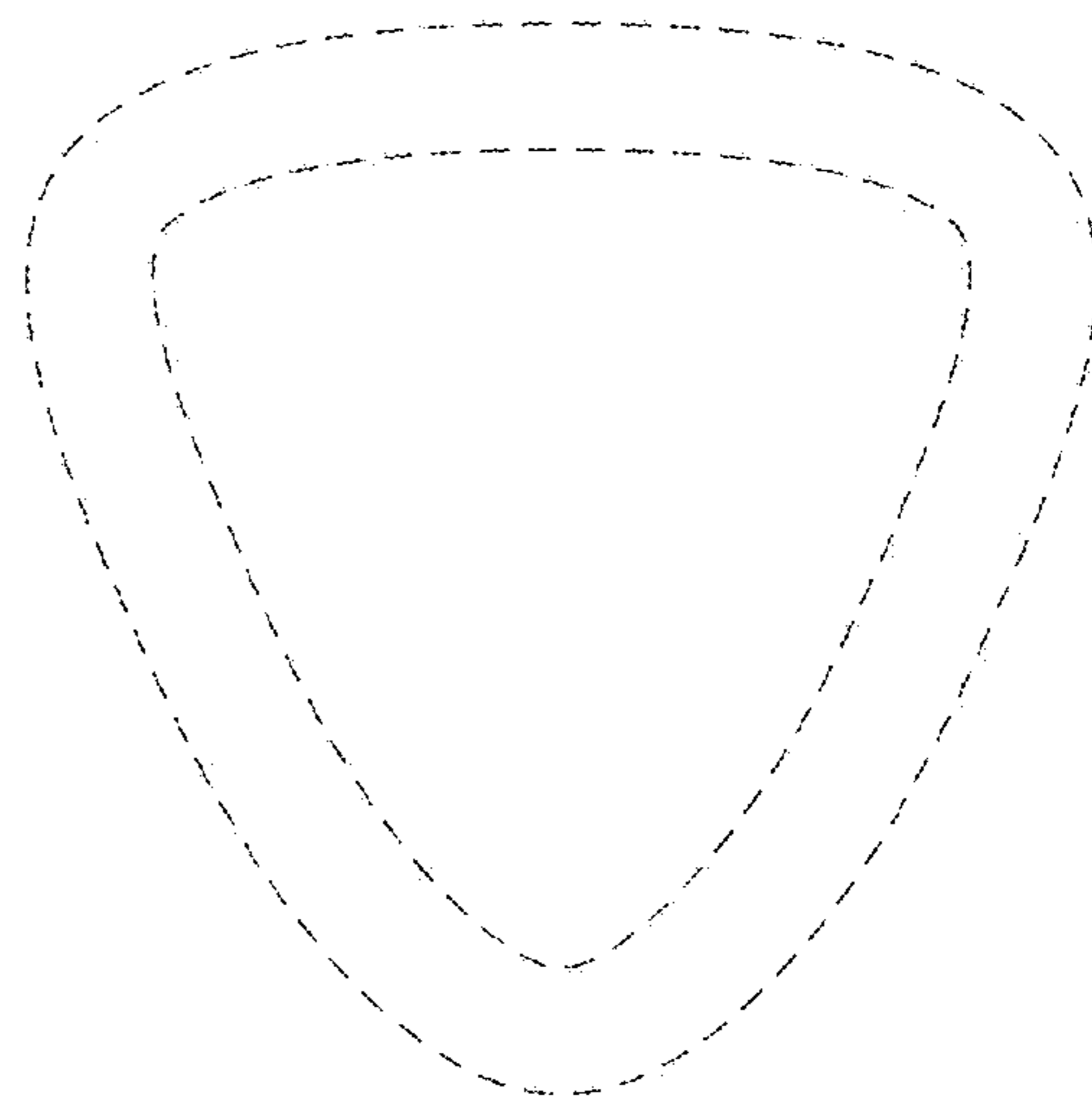

FIG. 14

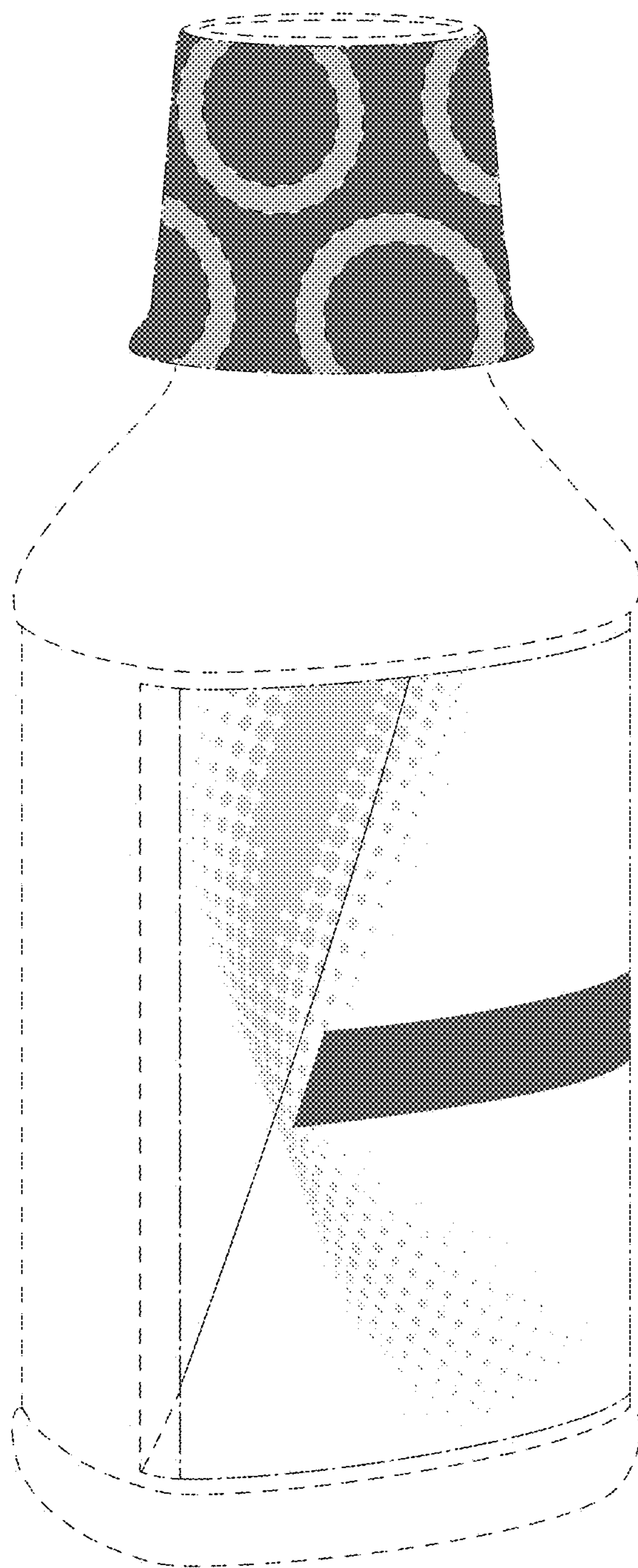

FIG. 15

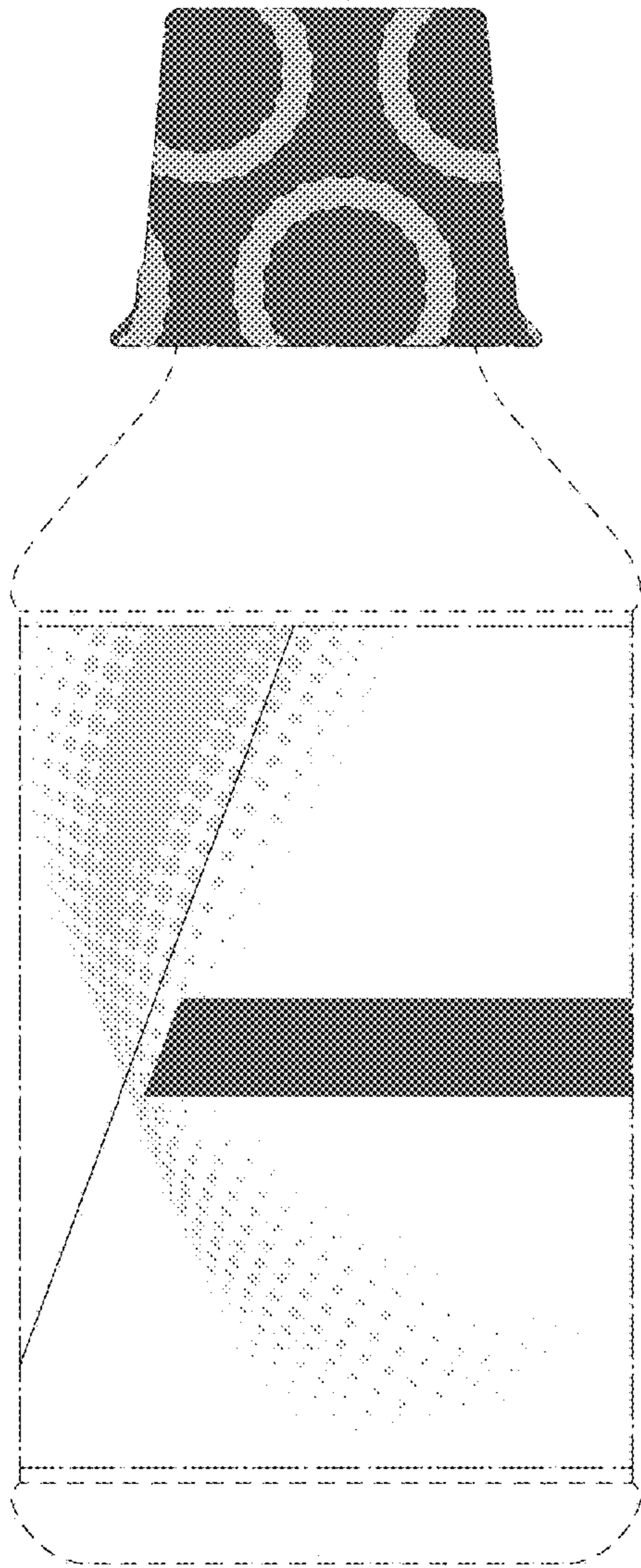

FIG. 16

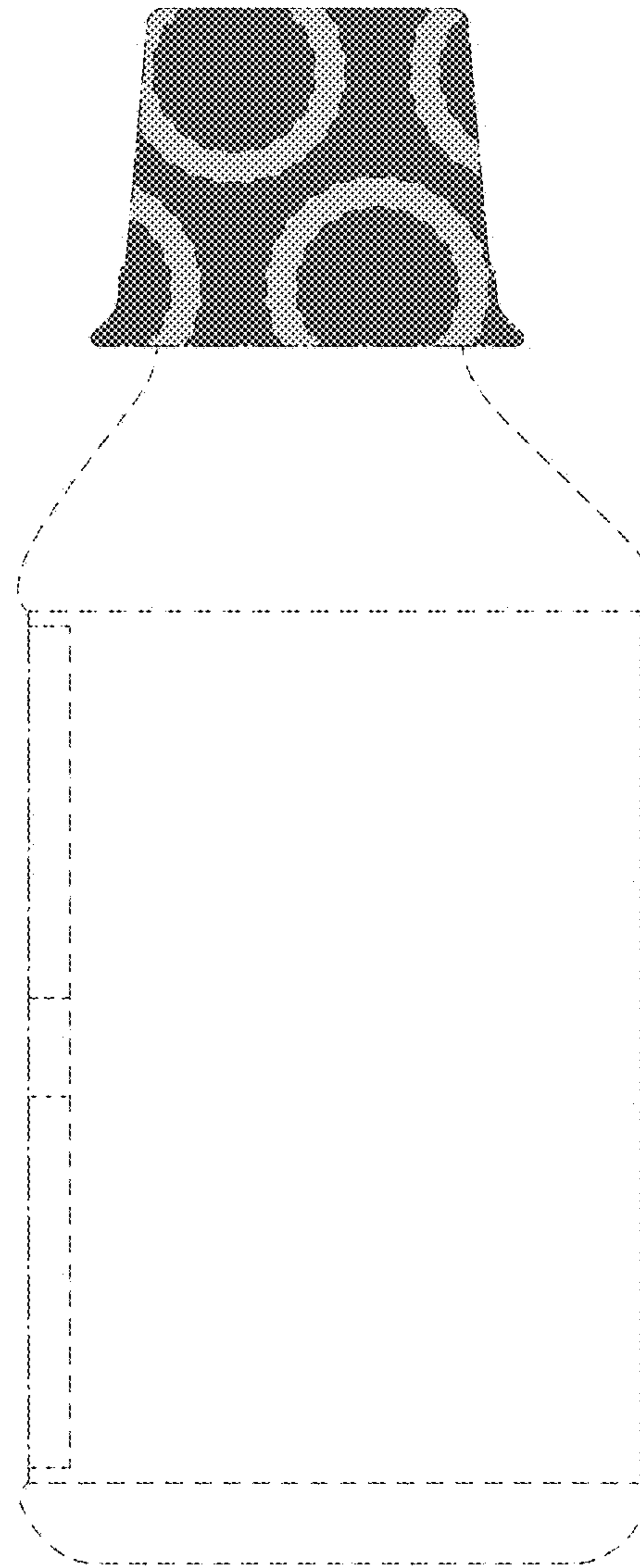

FIG. 17

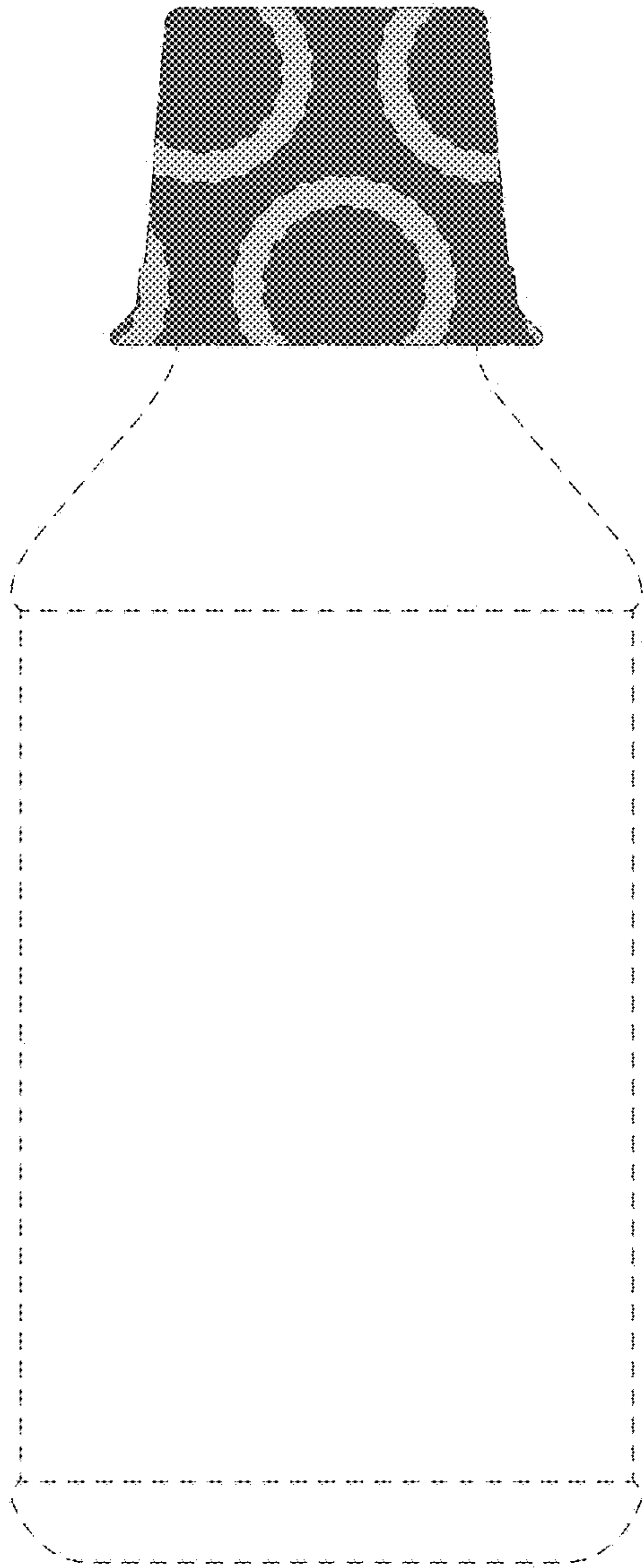

FIG. 18

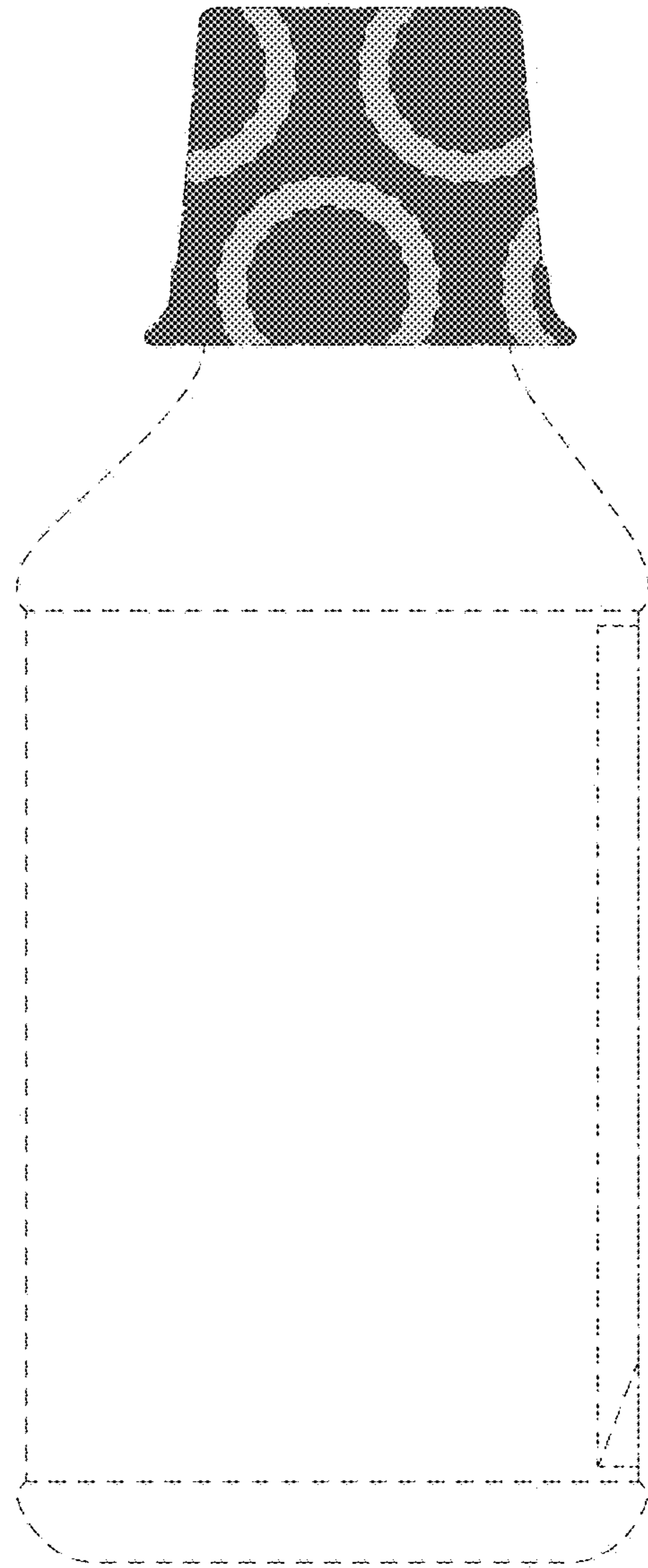

FIG. 19

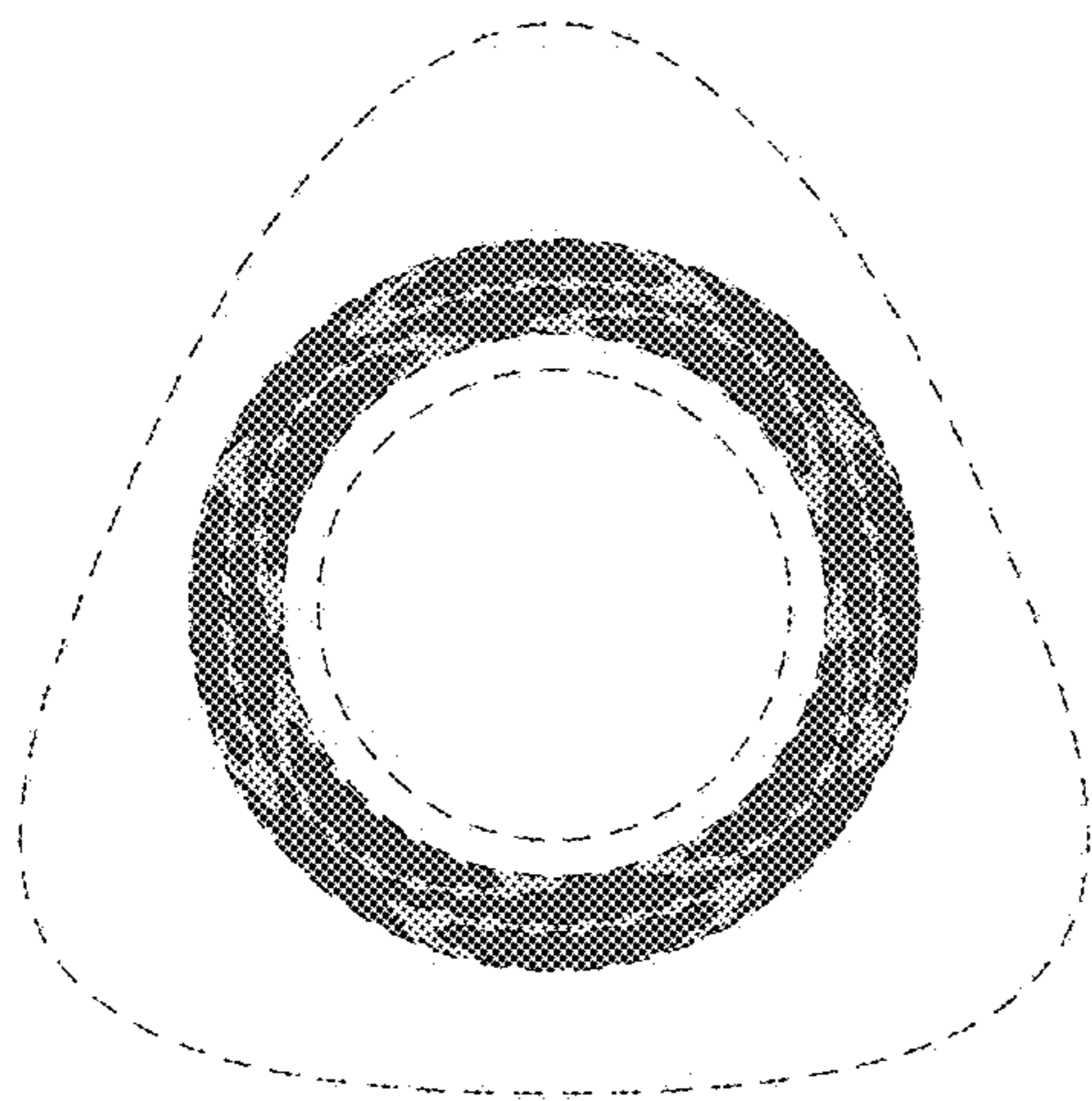

FIG. 20

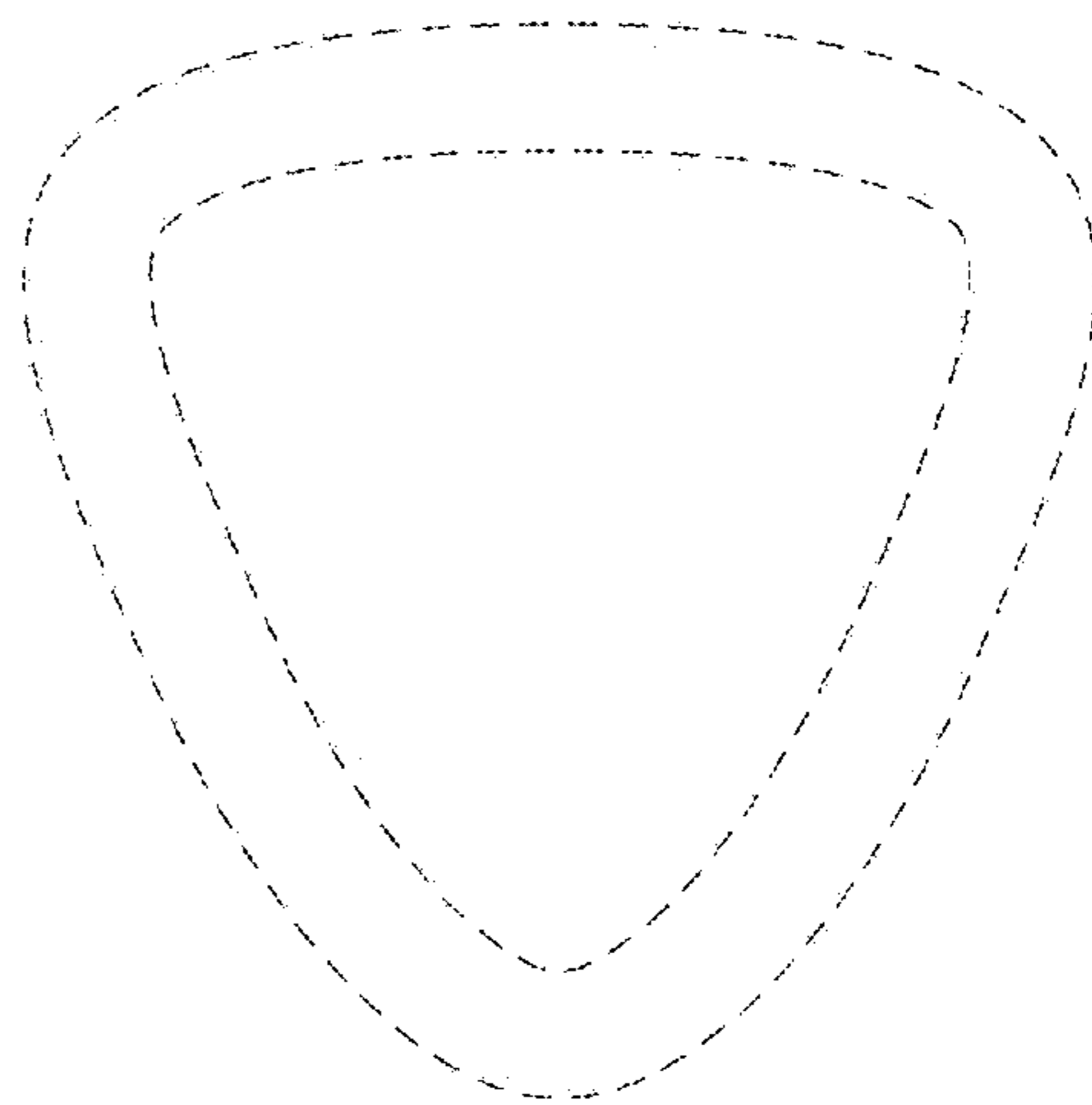

FIG. 21

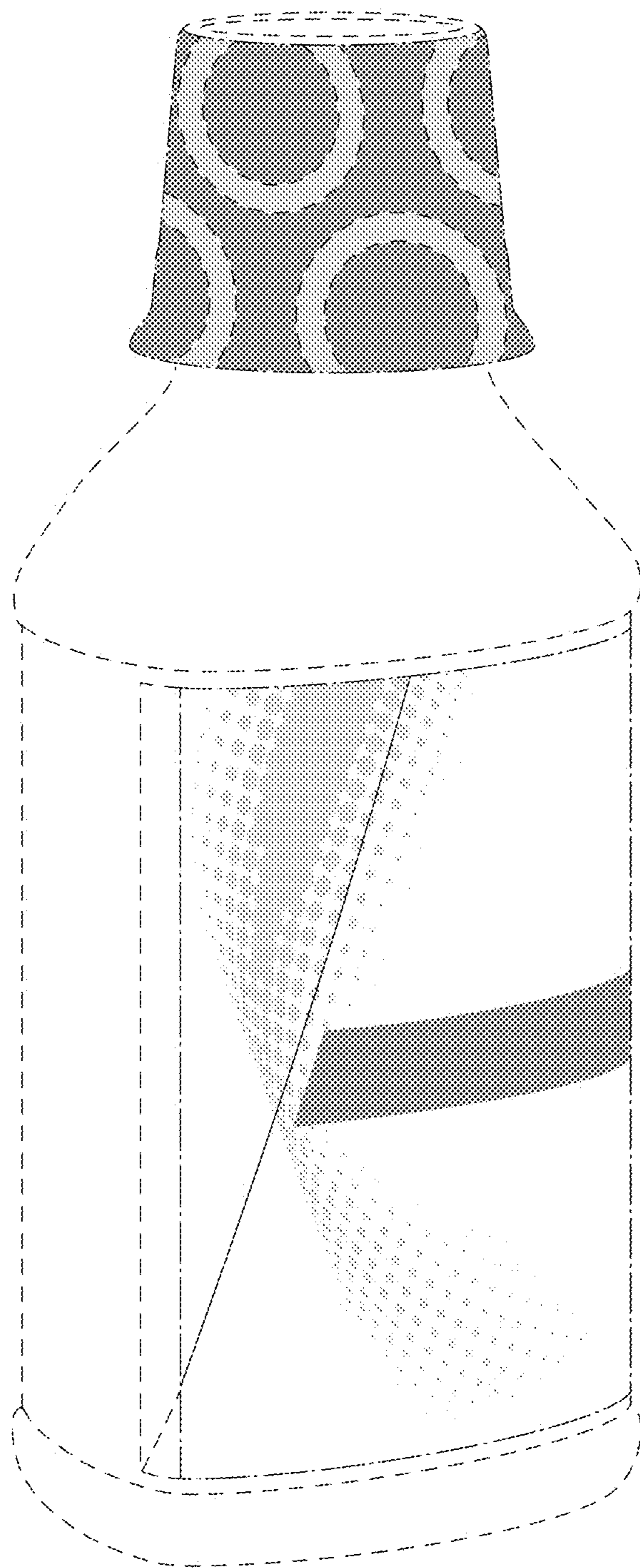

FIG. 22

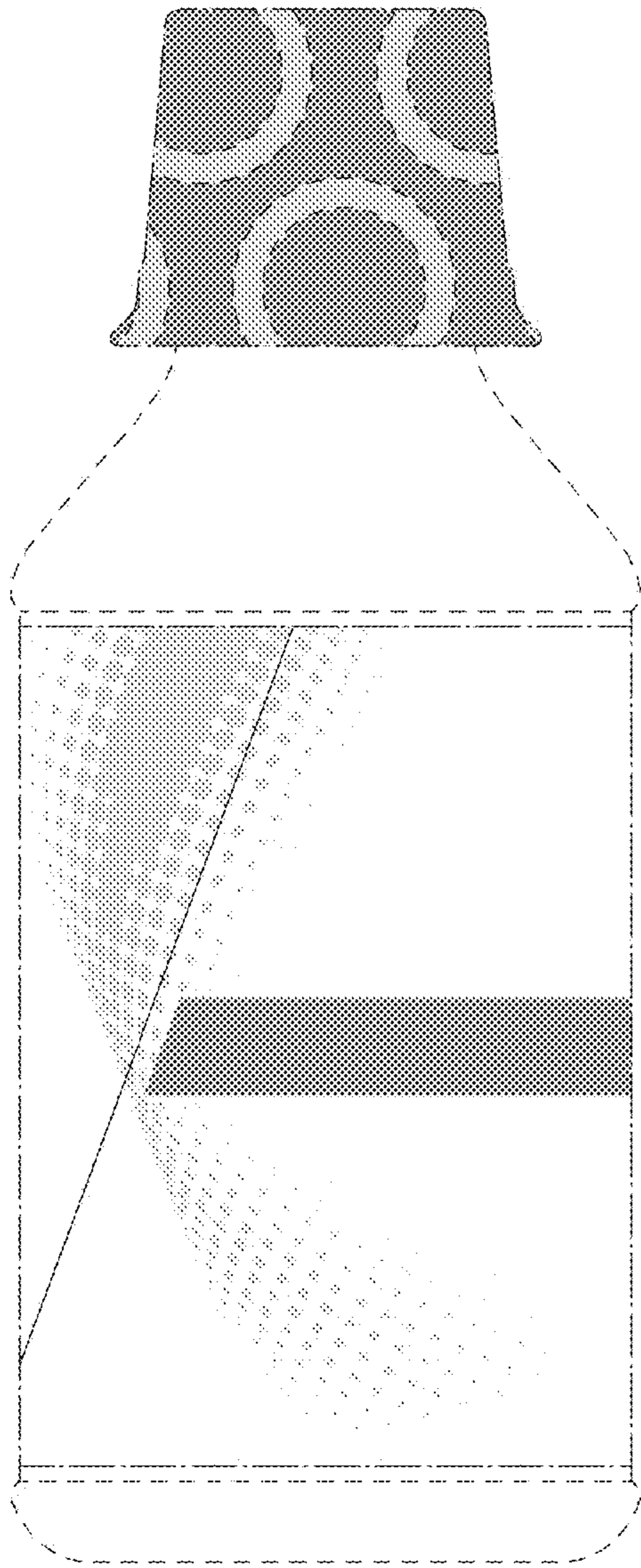

FIG. 23

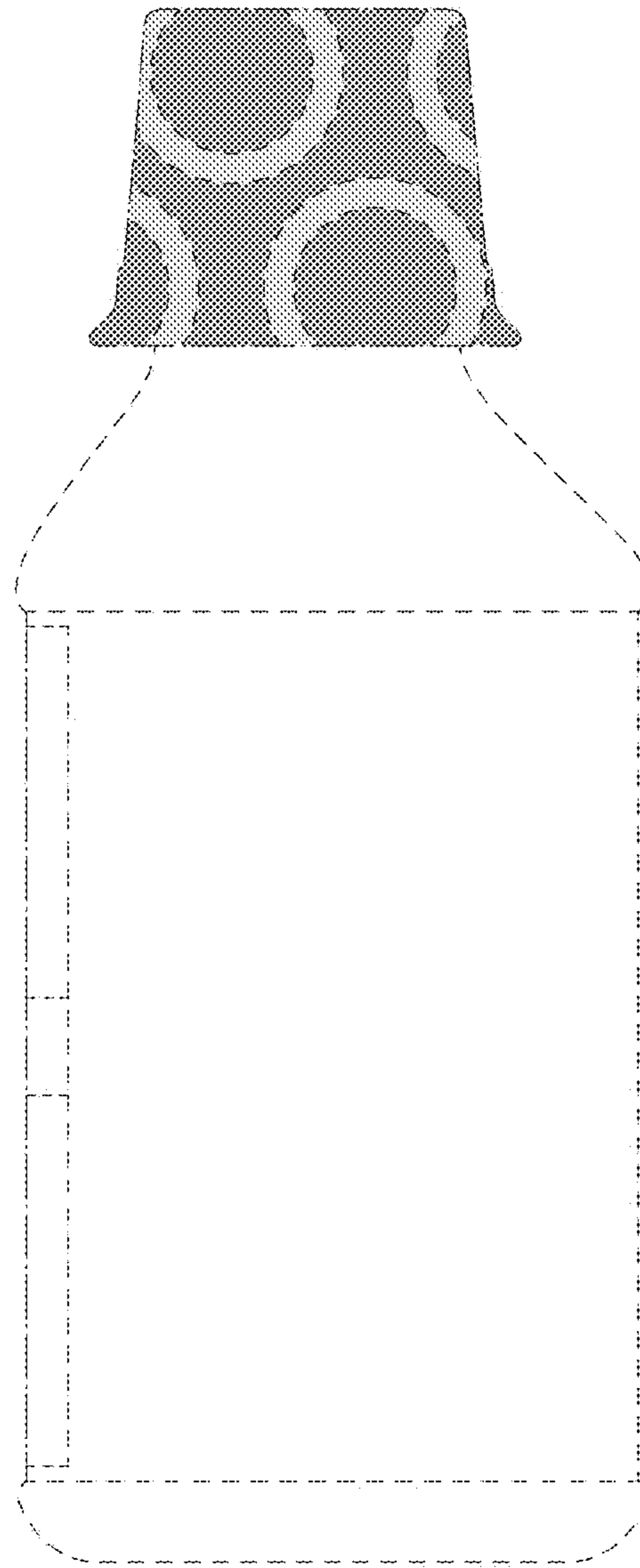

FIG. 24

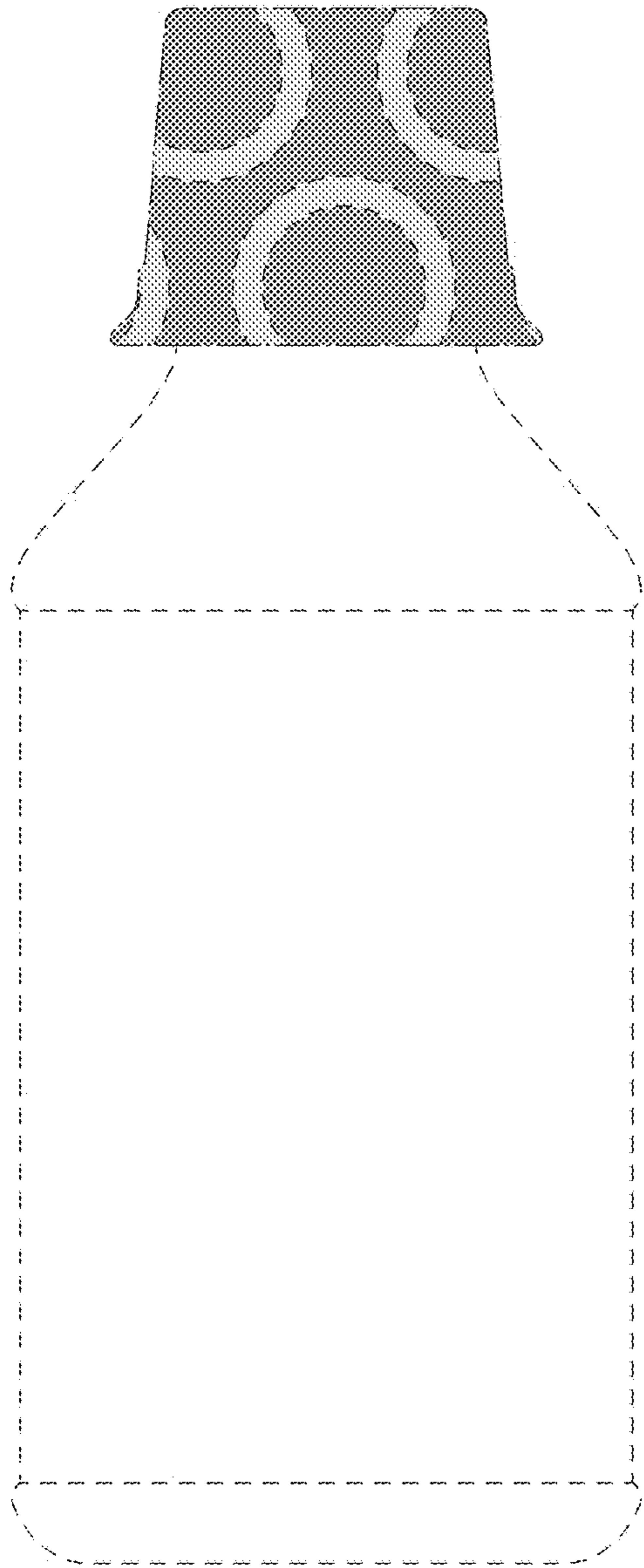

FIG. 25

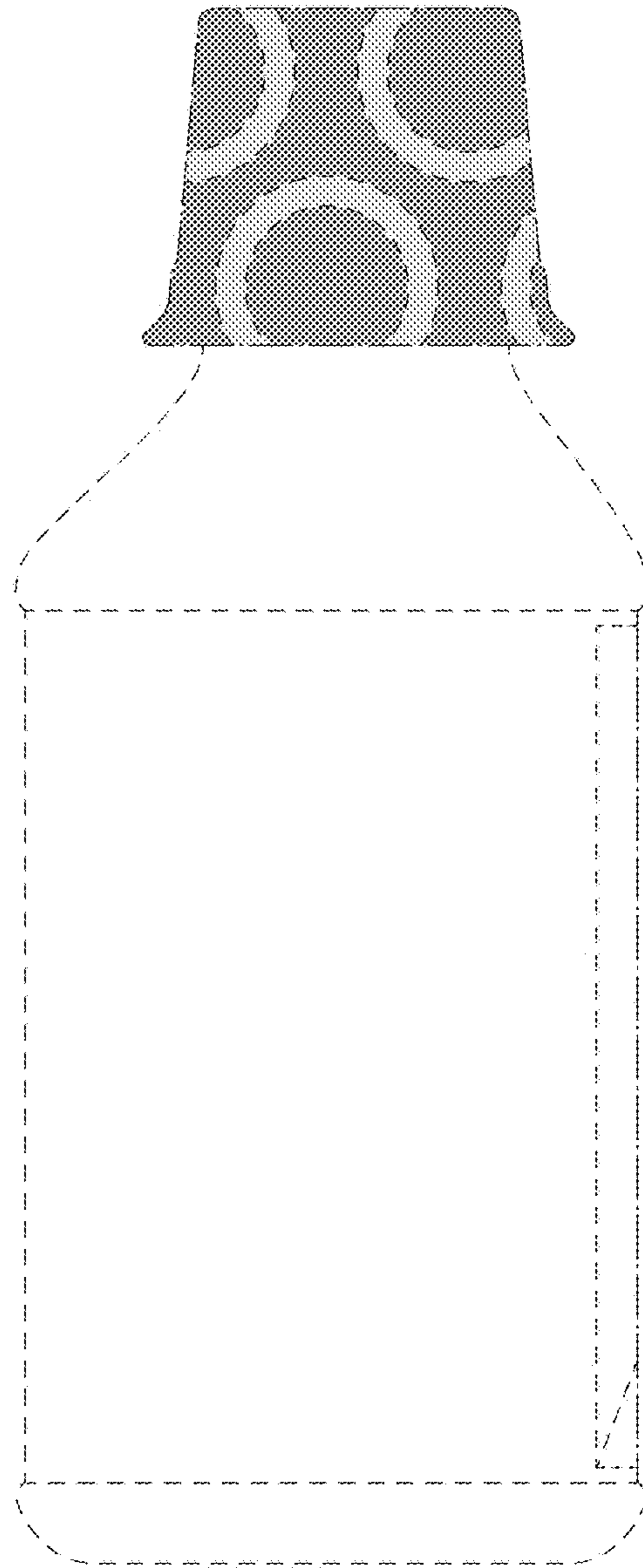

FIG. 26

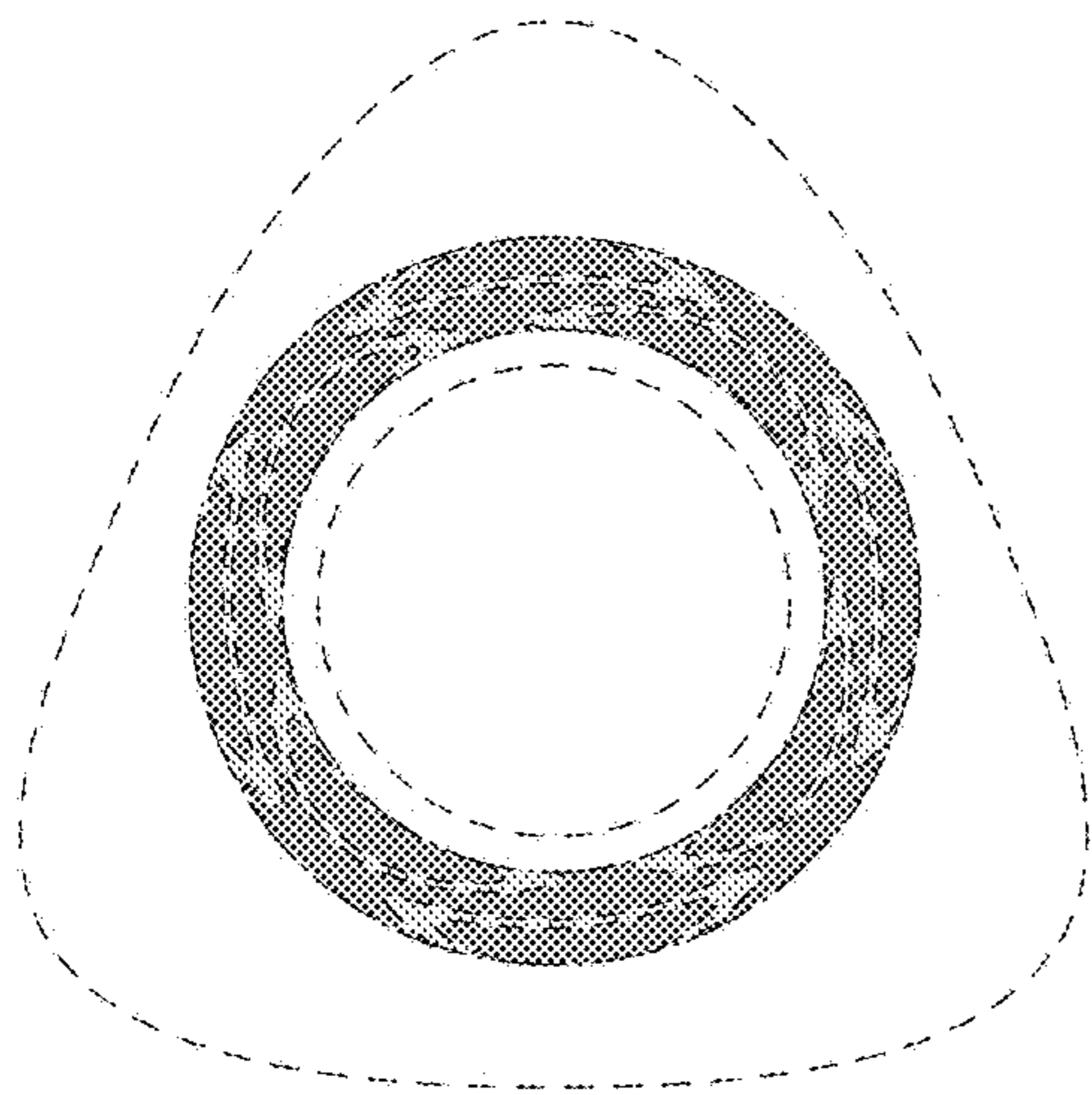

FIG. 27

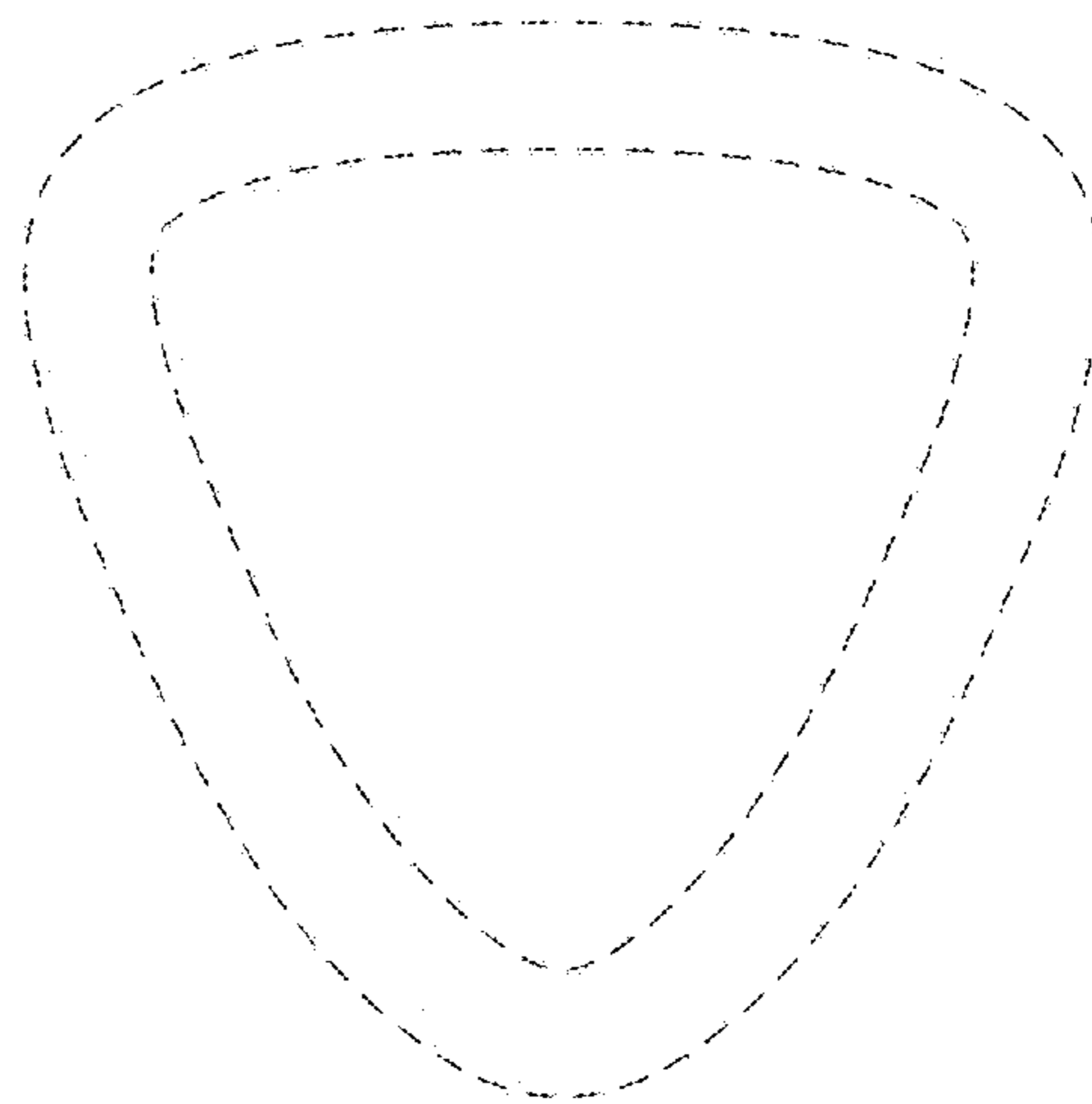

FIG. 28

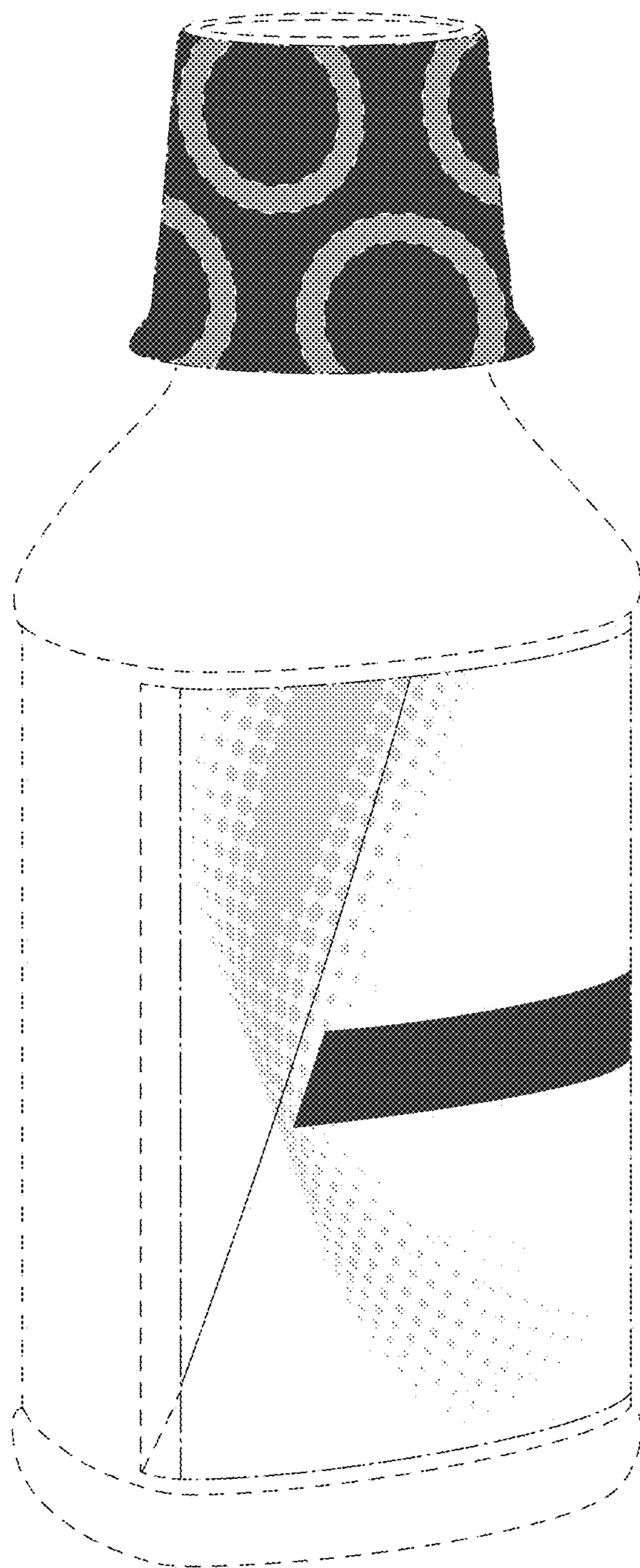

FIG. 29

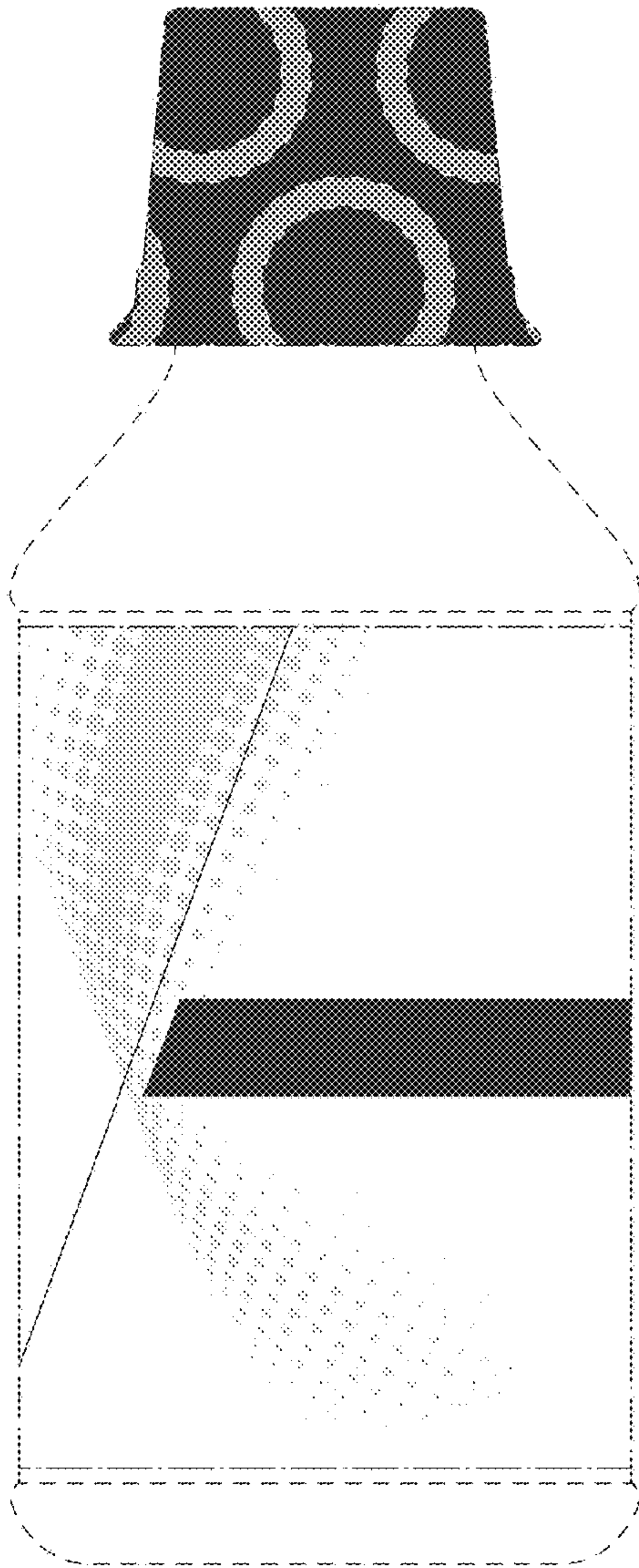

FIG. 30

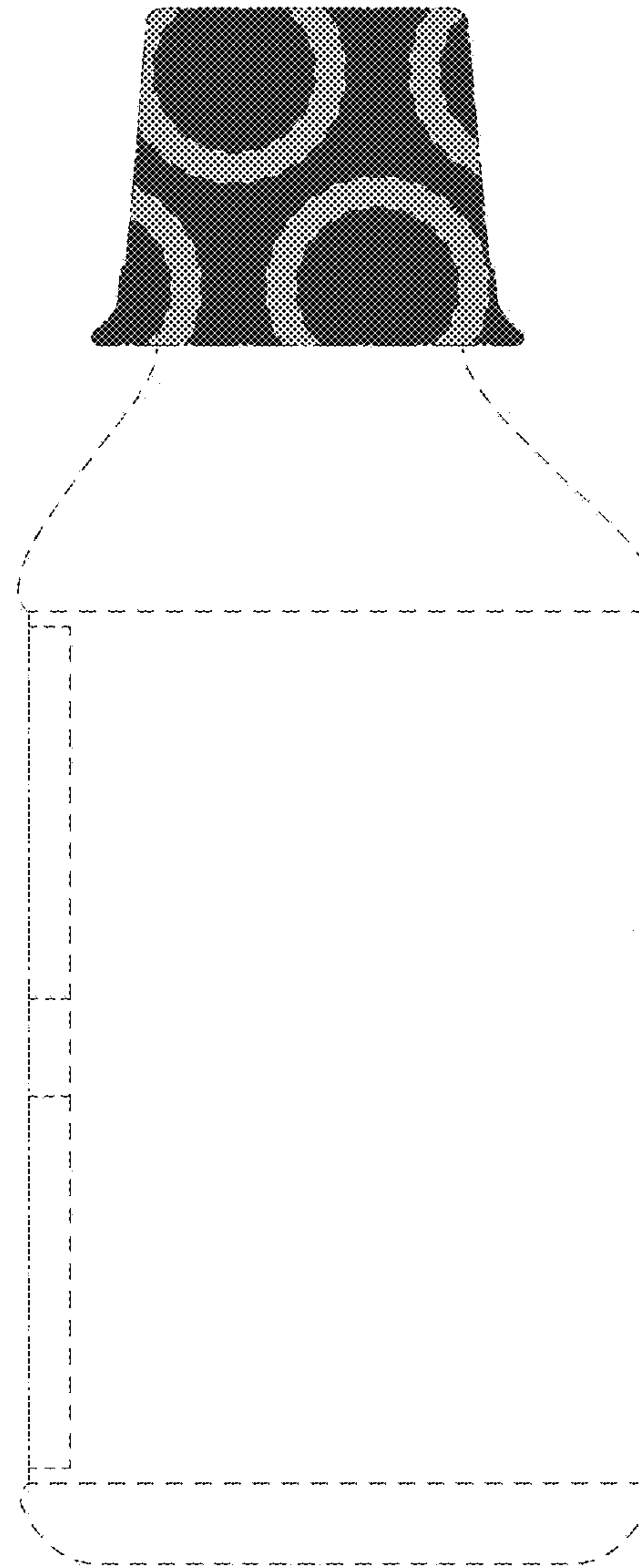

FIG. 31

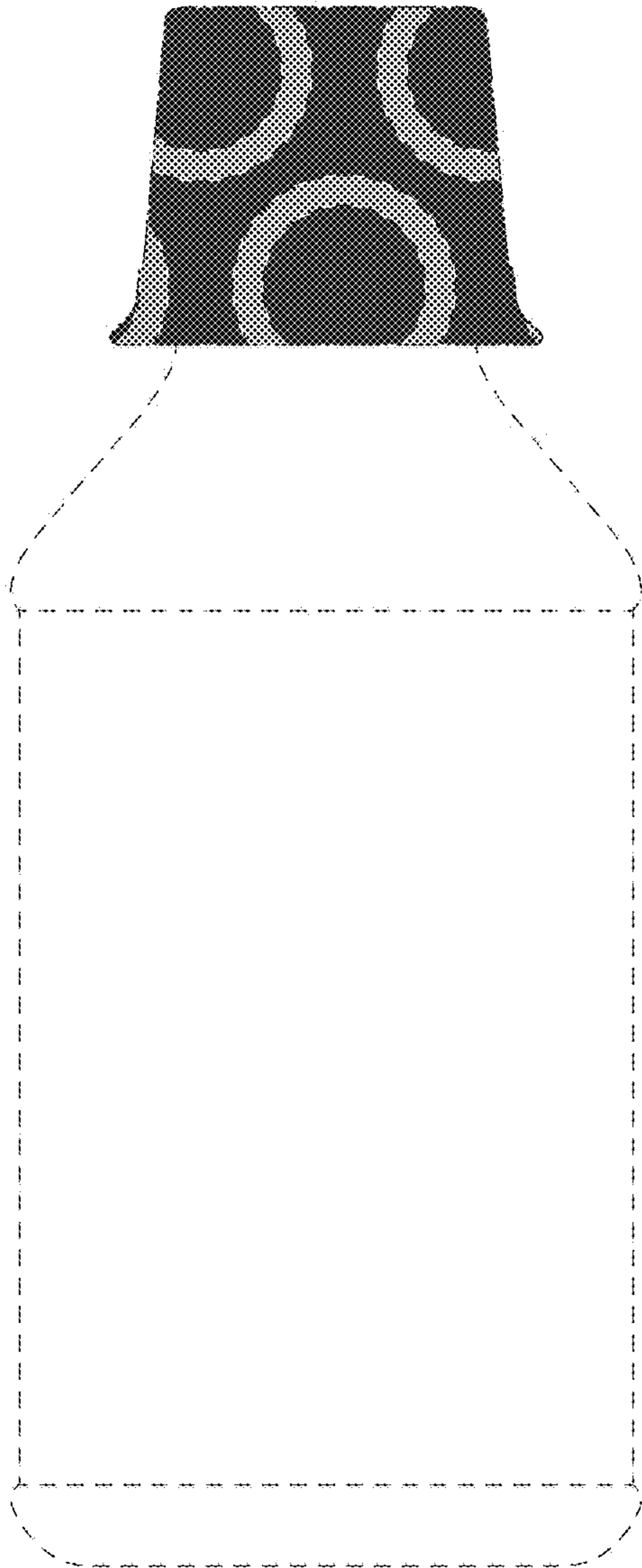

FIG. 32

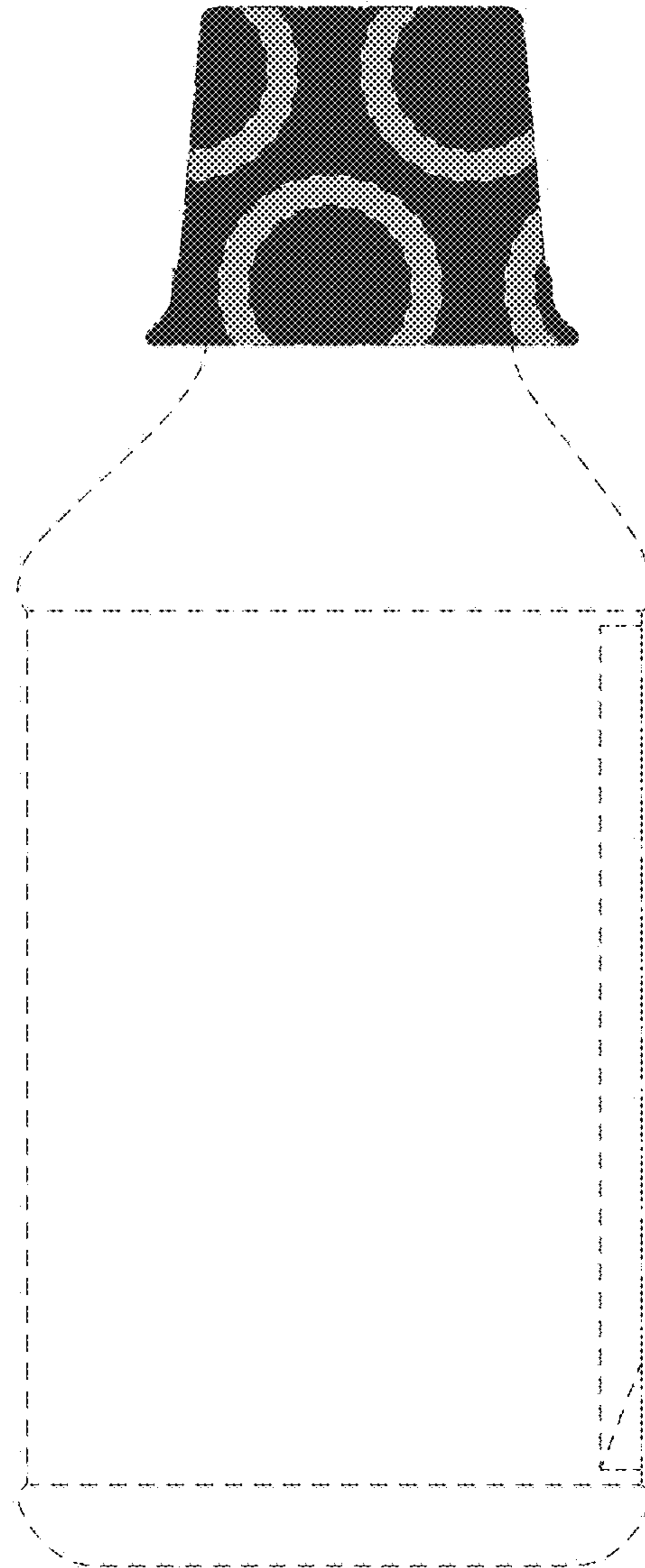

FIG. 33

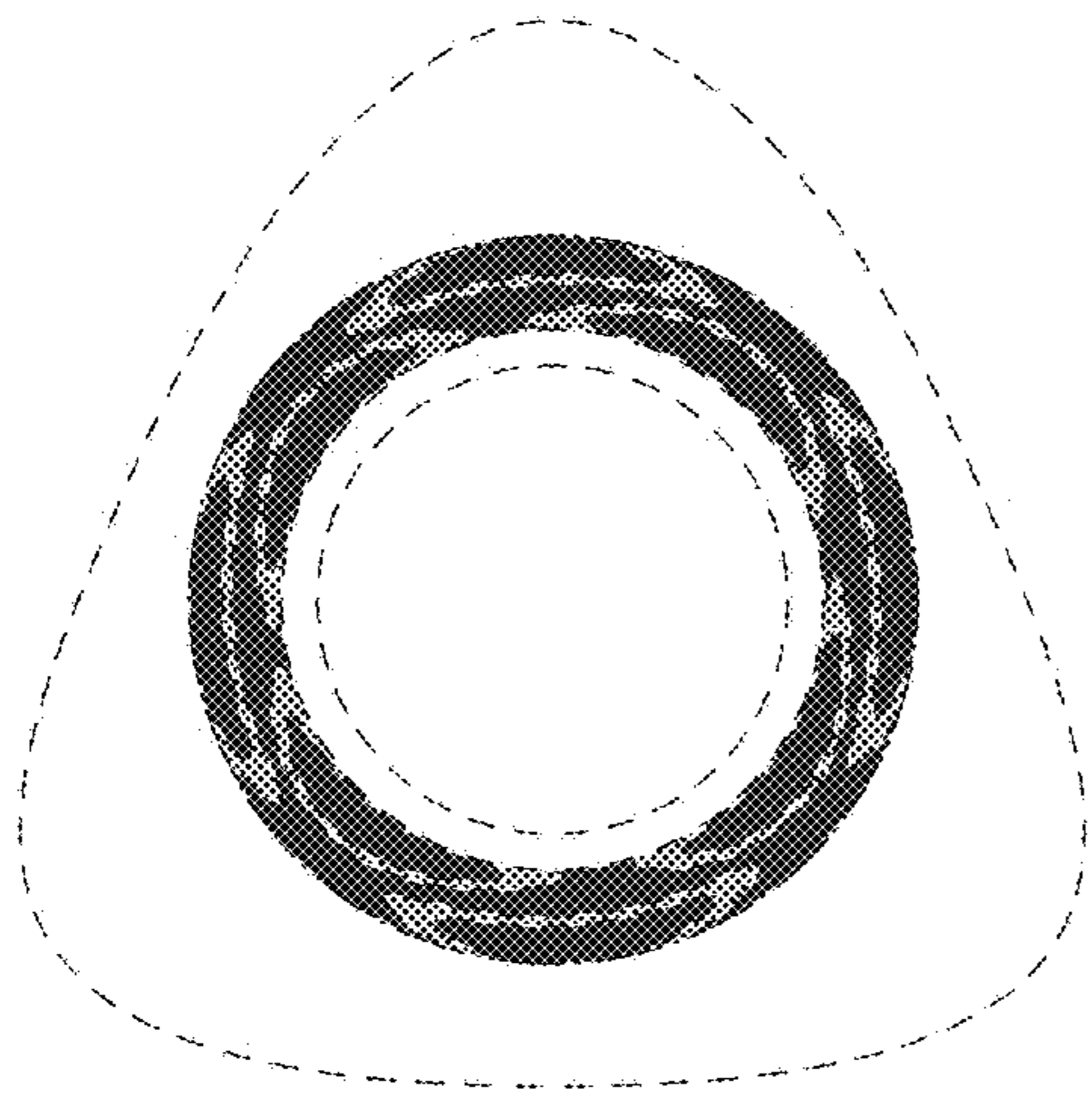

FIG. 34

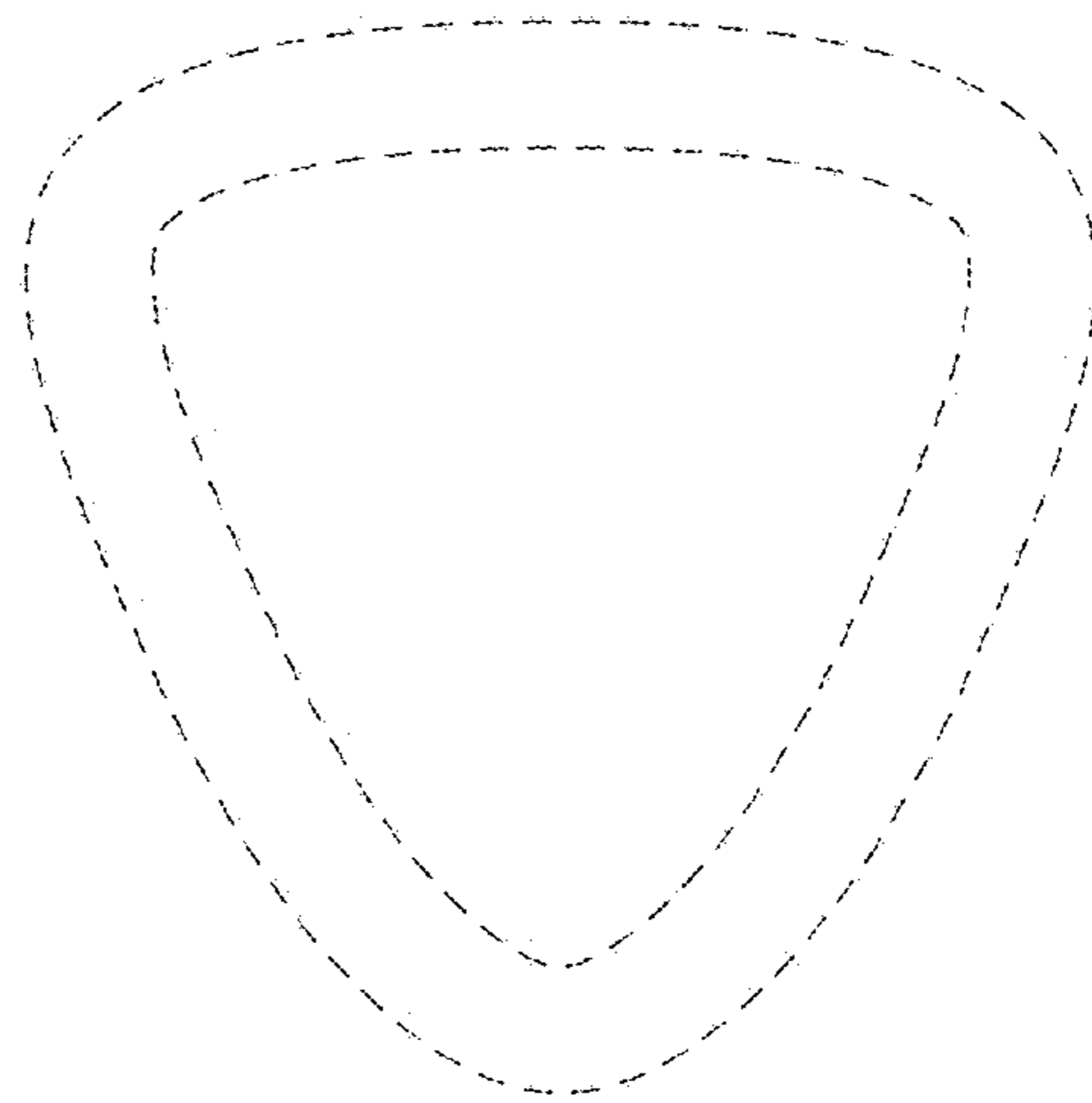

FIG. 35