



US00D824223S

(12) **United States Design Patent**  
**Zoske et al.**

(10) **Patent No.:** **US D824,223 S**  
(45) **Date of Patent:** **\*\* Jul. 31, 2018**

(54) **CONDIMENT GRINDER WITH FLIP-TOP LID**

D362,180 S 12/1995 Haines  
D372,643 S \* 8/1996 Tang ..... D7/679  
D382,167 S \* 8/1997 Husted ..... D7/679

(Continued)

(71) Applicant: **Saltworks, Inc.**, Woodinville, WA (US)

(72) Inventors: **Mark Zoske**, Snohomish, WA (US);  
**Colin McLane**, Snohomish, WA (US)

(73) Assignee: **Saltworks, Inc.**, Woodinville, WA (US)

(\*\*) Term: **15 Years**

(21) Appl. No.: **29/588,334**

(22) Filed: **Dec. 20, 2016**

(51) **LOC (11) Cl.** ..... **07-04**

(52) **U.S. Cl.**  
USPC ..... **D7/679**

(58) **Field of Classification Search**  
USPC ... D7/300.1, 372-374, 381, 383, 384, 401.1,  
D7/590-600, 679; D9/500, 503, 504,  
D9/516, 549, 556, 559, 574, 575;  
D27/102, 110, 126, 127, 129, 172, 175,  
D27/184, 186, 194, 195  
CPC .. A47J 42/00; A47J 42/04; A47J 42/14; A47J  
42/18; A47J 42/24; A47J 42/34; A47J  
42/42; A47J 42/46; A47J 43/06; A47J  
43/25; A47J 43/255; A24C 5/40  
See application file for complete search history.

(56) **References Cited**

**U.S. PATENT DOCUMENTS**

2,200,755 A \* 5/1940 McArthur ..... A47G 19/24  
222/142.5  
D199,138 S \* 9/1964 Hazlett ..... D7/591  
D249,922 S \* 10/1978 Hall ..... D7/668  
D257,204 S \* 10/1980 Bounds ..... D7/596  
D257,205 S \* 10/1980 Bounds ..... D7/596  
D276,400 S 11/1984 Daenen et al.  
D287,210 S \* 12/1986 Bounds ..... D7/596  
D303,086 S 8/1989 Rothfos  
D349,432 S \* 8/1994 Kibbe ..... D26/38

**OTHER PUBLICATIONS**

Youtube. SaltWorks, Inc.—Artisan Salt Reimagined. Jan. 21, 2017  
[earliest online date], [site visited Sep. 21, 2017]. Available from  
Internet, <URL:https://www.youtube.com/  
watch?v=3NhEeMUSTVvk&feature=youtu.be>. (Year: 2017).\*

(Continued)

*Primary Examiner* — Eric L Goodman  
*Assistant Examiner* — Darcey E Heflin  
(74) *Attorney, Agent, or Firm* — Hanrahan Law Firm,  
P.A.; Benjamin M. Hanrahan

(57) **CLAIM**

The ornamental design for a condiment grinder with flip-top lid, as shown and described.

**DESCRIPTION**

FIG. 1 is a front left perspective view illustrating our design for a condiment grinder with flip-top lid.  
FIG. 2 is a front view thereof.  
FIG. 3 is a left side view thereof.  
FIG. 4 is a rear view thereof.  
FIG. 5 is a right side view thereof.  
FIG. 6 is another right side view thereof, with the flip-top lid in an open position.  
FIG. 7 is a bottom view thereof.  
FIG. 8 is a top view thereof; and,  
FIG. 9 is another top view thereof, with the flip-top lid in the open position.  
The broken lines in the drawings illustrate portions of the article that form no part of the claimed design. The stippling used in the drawings is to indicate portions of the article that are translucent.

**1 Claim, 7 Drawing Sheets**

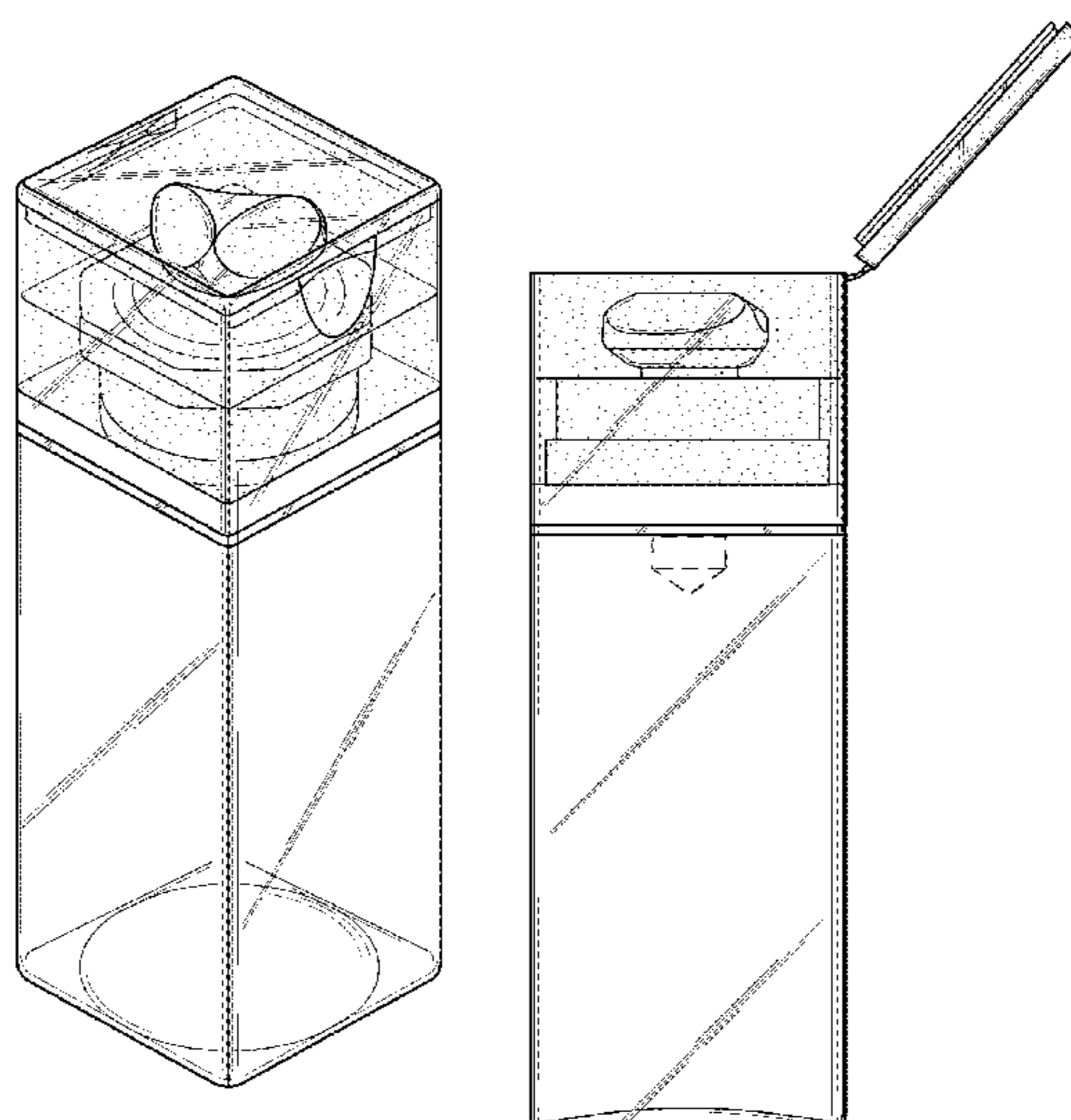

(56)

**References Cited**

## U.S. PATENT DOCUMENTS

D393,570 S 4/1998 Zeller  
D423,346 S 4/2000 Froehlich et al.  
D463,276 S 9/2002 Piscopo et al.  
D467,773 S \* 12/2002 Wright ..... D7/679  
D508,375 S \* 8/2005 Hoour ..... D7/598  
D525,873 S 8/2006 Haubert et al.  
D531,043 S \* 10/2006 Houtart ..... D9/432  
D545,148 S \* 6/2007 Marshall ..... D7/679  
D545,149 S \* 6/2007 Marshall ..... D7/679  
D570,651 S \* 6/2008 Lin ..... D7/679  
D571,197 S 6/2008 Sanfilippo et al.  
D590,720 S \* 4/2009 Oates ..... D9/560  
D612,152 S 3/2010 Roesler  
D626,385 S \* 11/2010 Mixdorf ..... 7/680  
D639,669 S \* 6/2011 Adler ..... D9/435  
D669,777 S 10/2012 Brown et al.  
D699,507 S \* 2/2014 Schmidt ..... D7/381  
D726,334 S 4/2015 O'Callaghan et al.  
D769,125 S \* 10/2016 Rizzotti ..... D9/435  
D770,296 S \* 11/2016 Rothfos ..... D9/432

## OTHER PUBLICATIONS

SaltWorks. Reinventing Artisan Salt Co. 2017 [earliest online date], [site visited Sep. 21, 2017]. Available from Internet, <URL: <https://www.seasalt.com/wholesale/artisan-salt-story>>. (Year: 2017).\*

Cole & Mason. Salt & Pepper Mills. 2017 [earliest online date], [site visited Sep. 21, 2017]. Available from Internet, <URL: <https://www.coleandmasonusa.com/product-category/salt-and-pepper-mills/page/2/>>. (Year: 2017).\*

\* cited by examiner

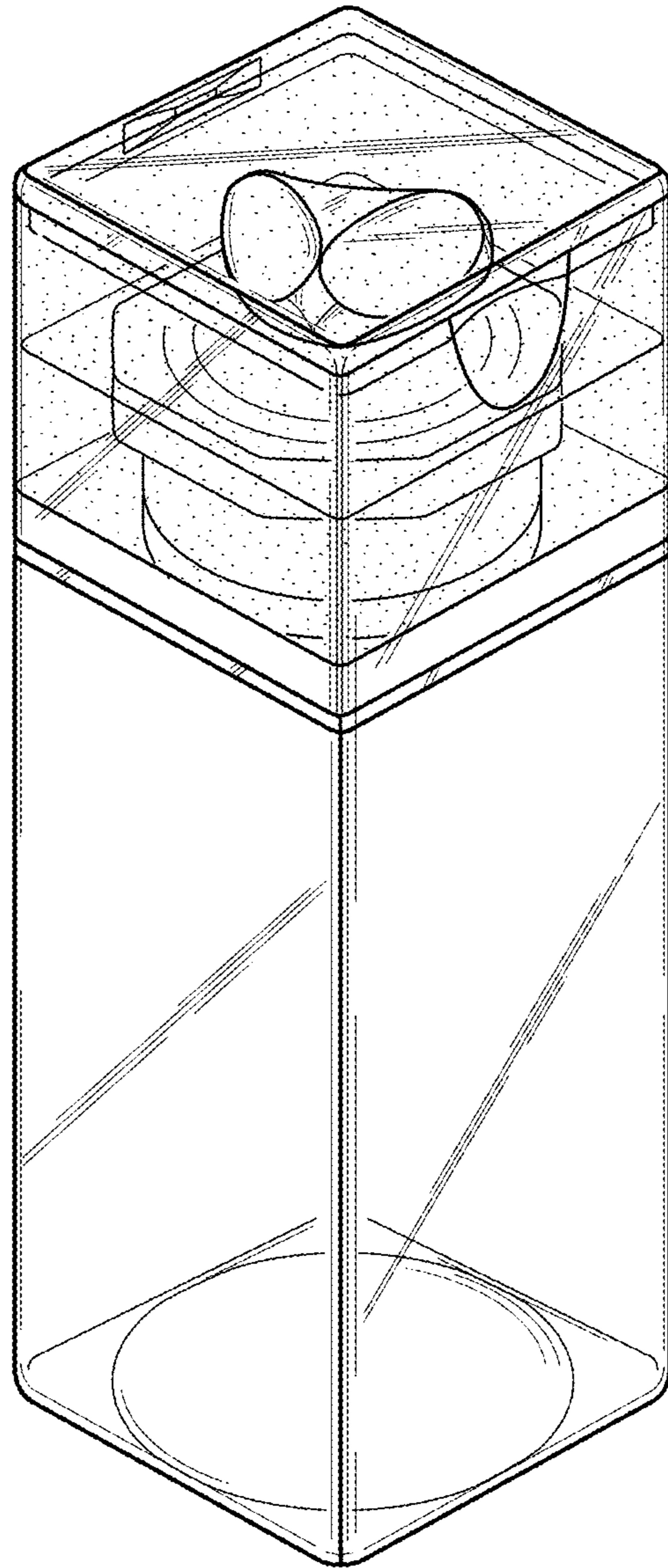

FIG. 1

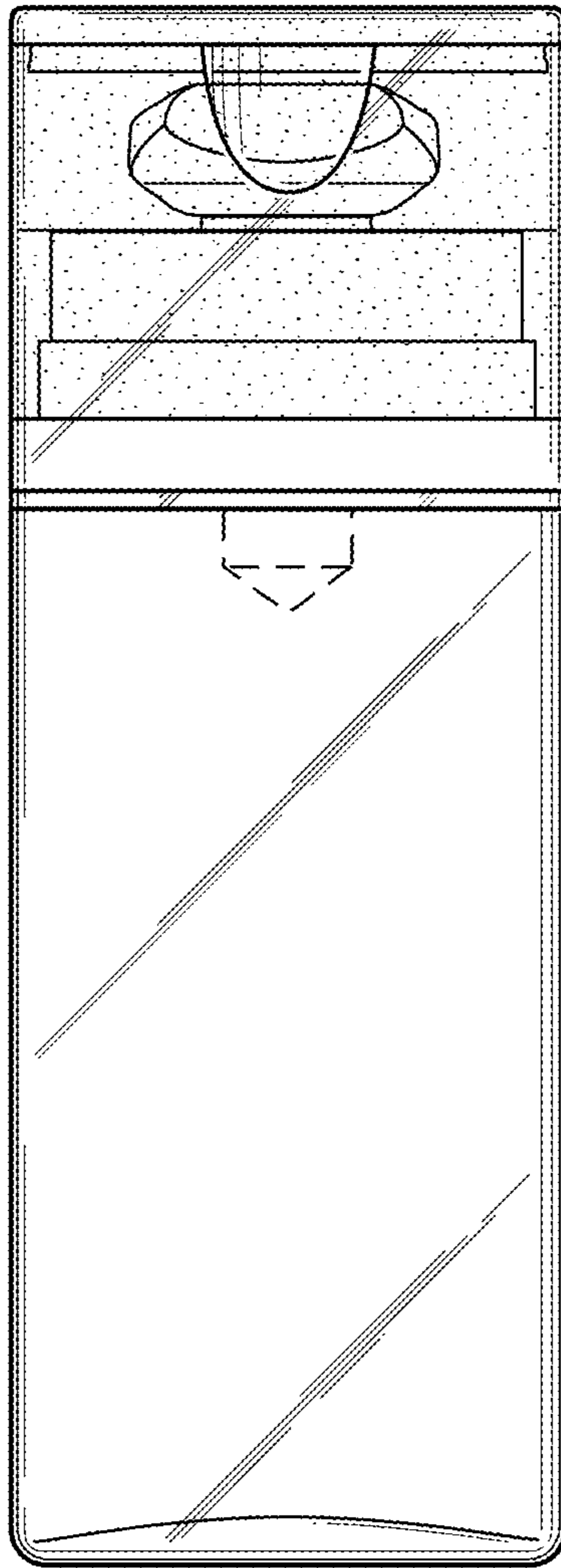

FIG. 2

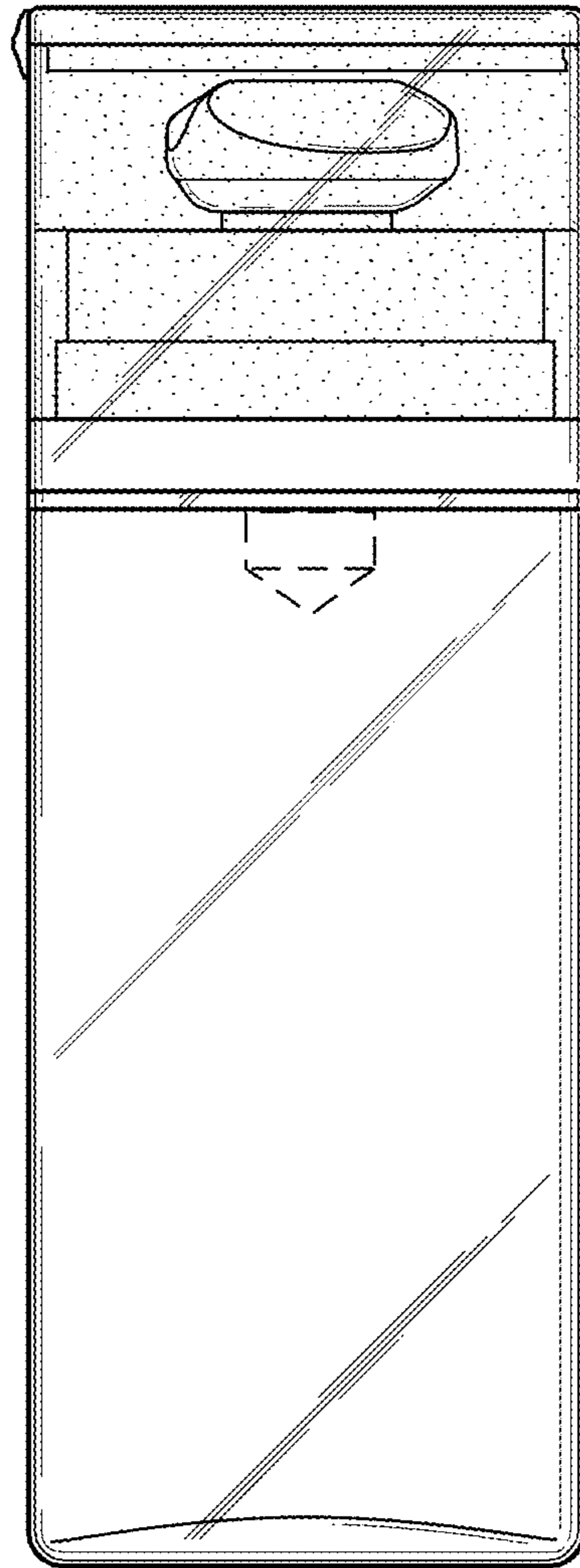

FIG. 3

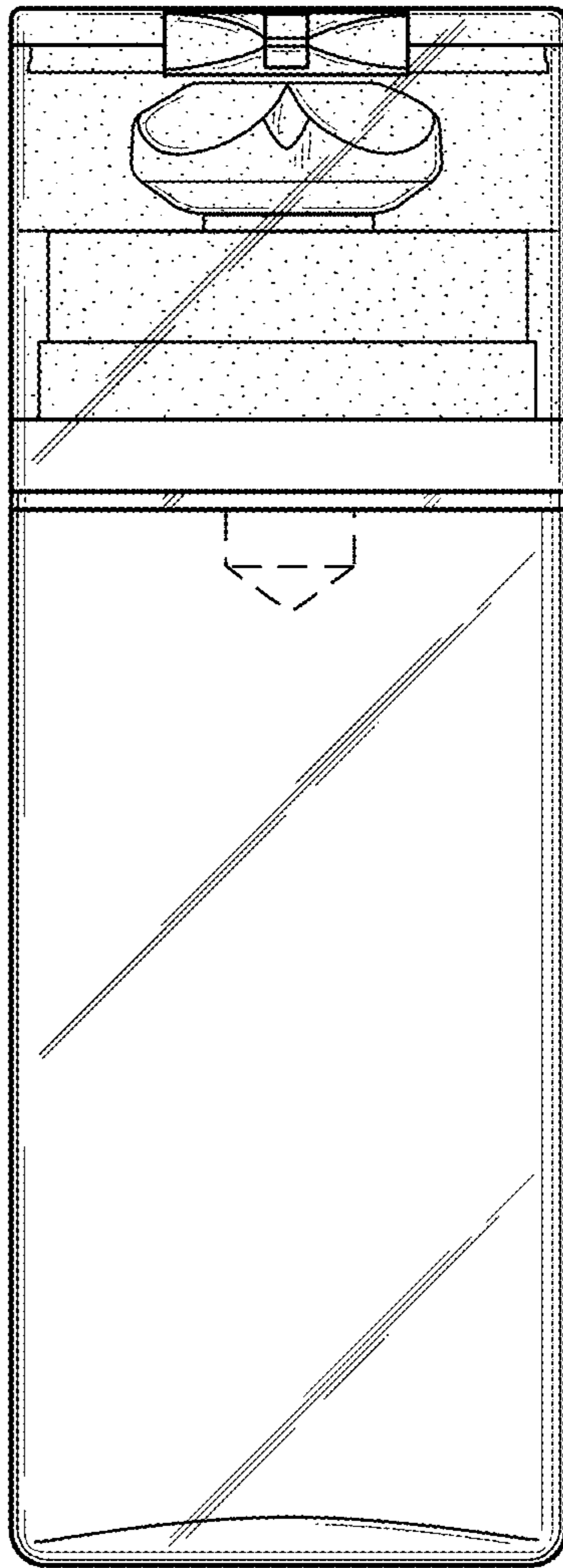

FIG. 4

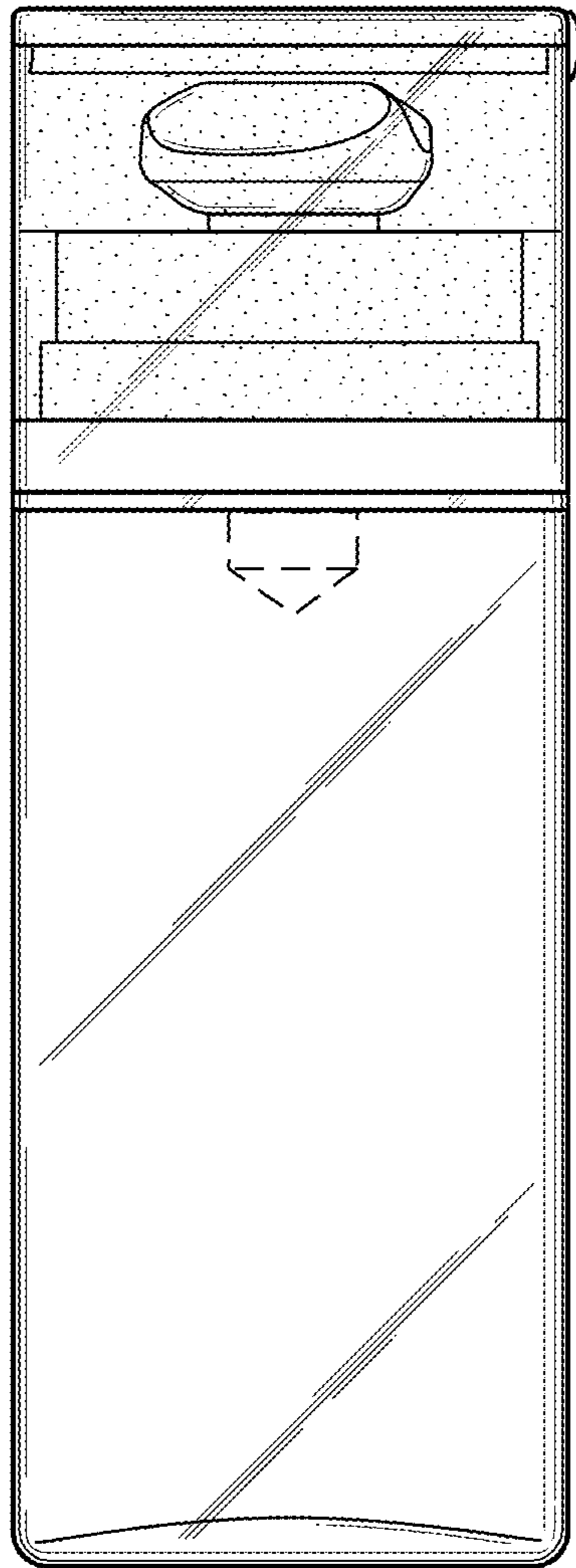

FIG. 5

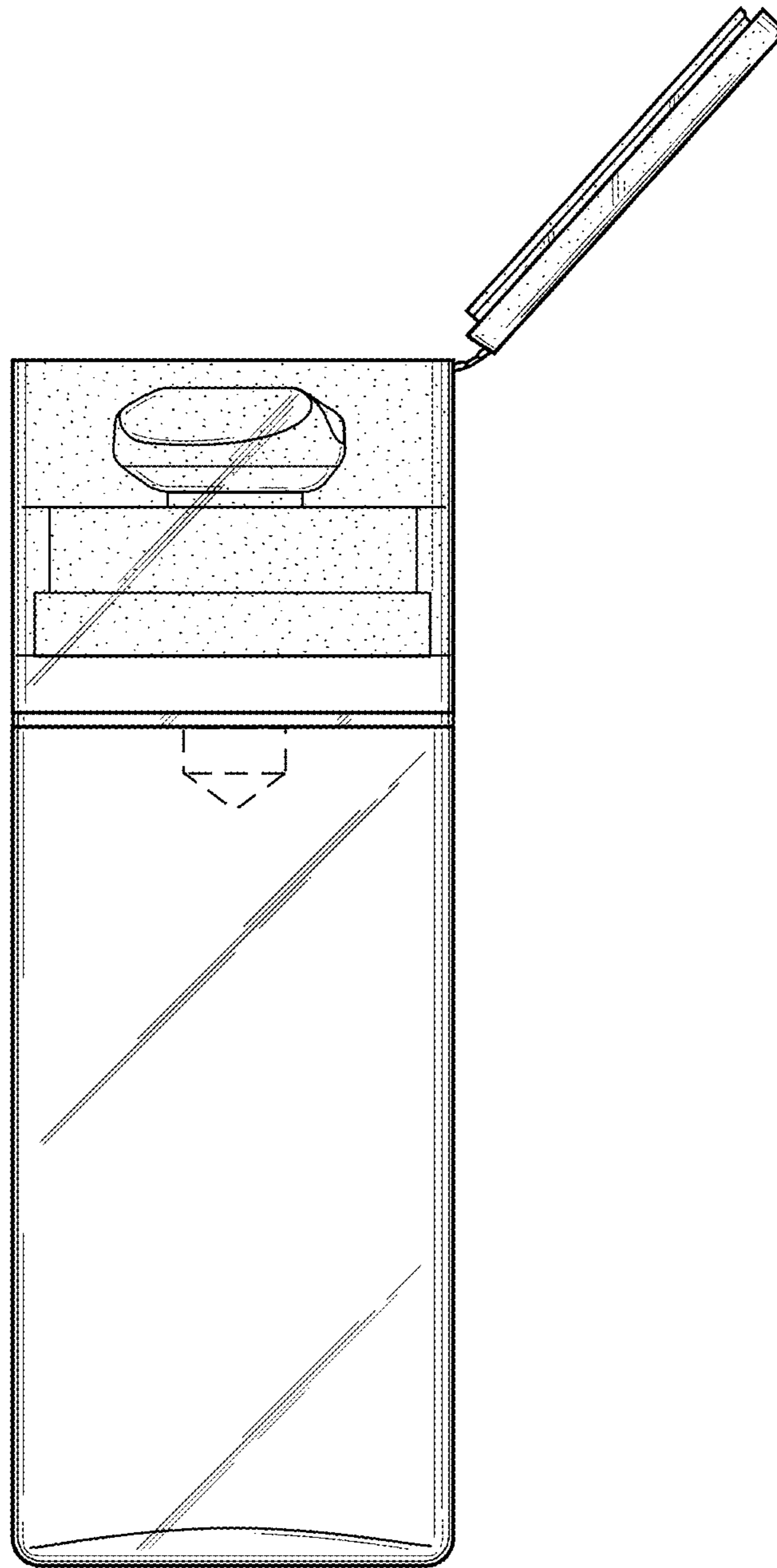
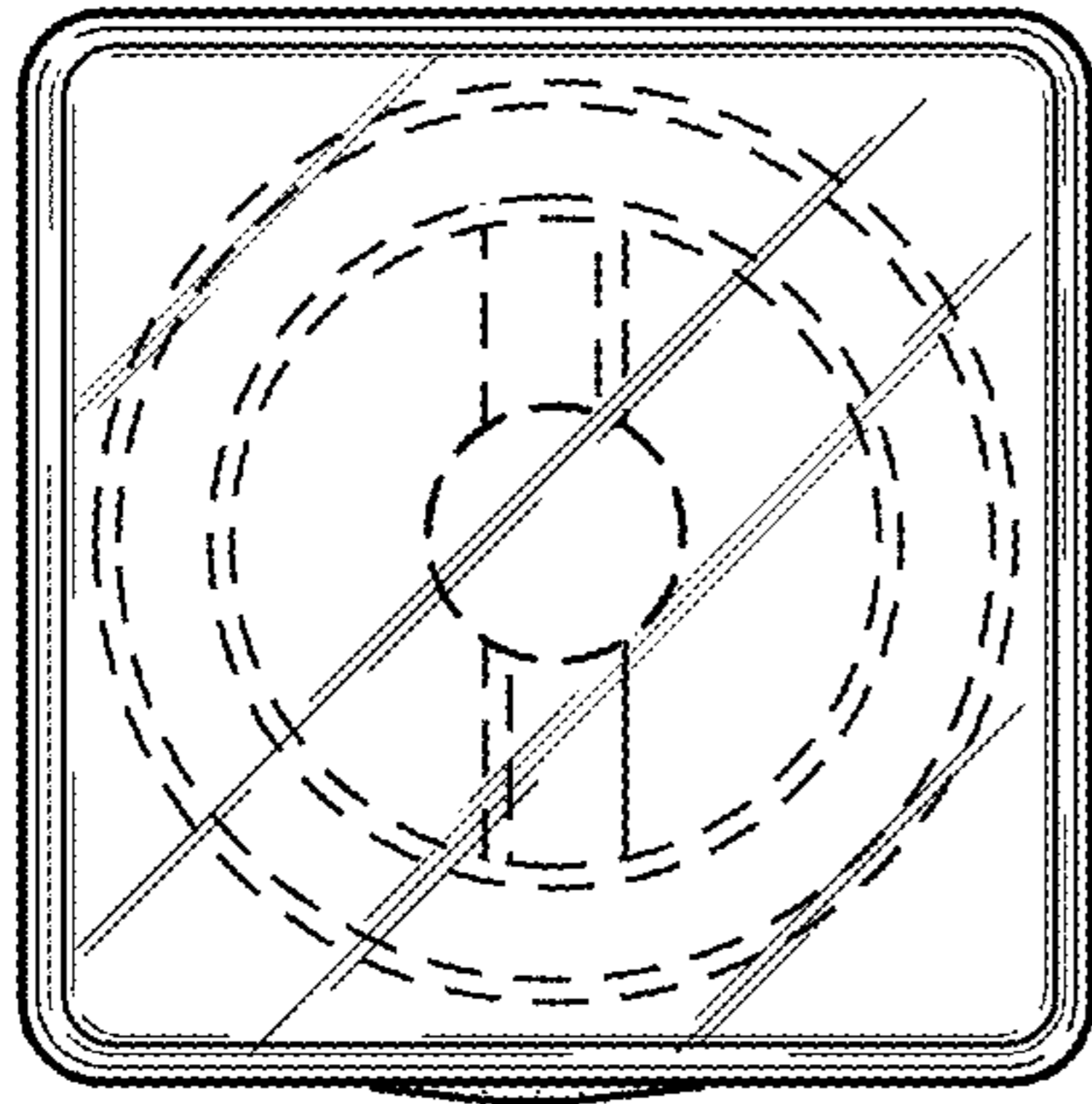
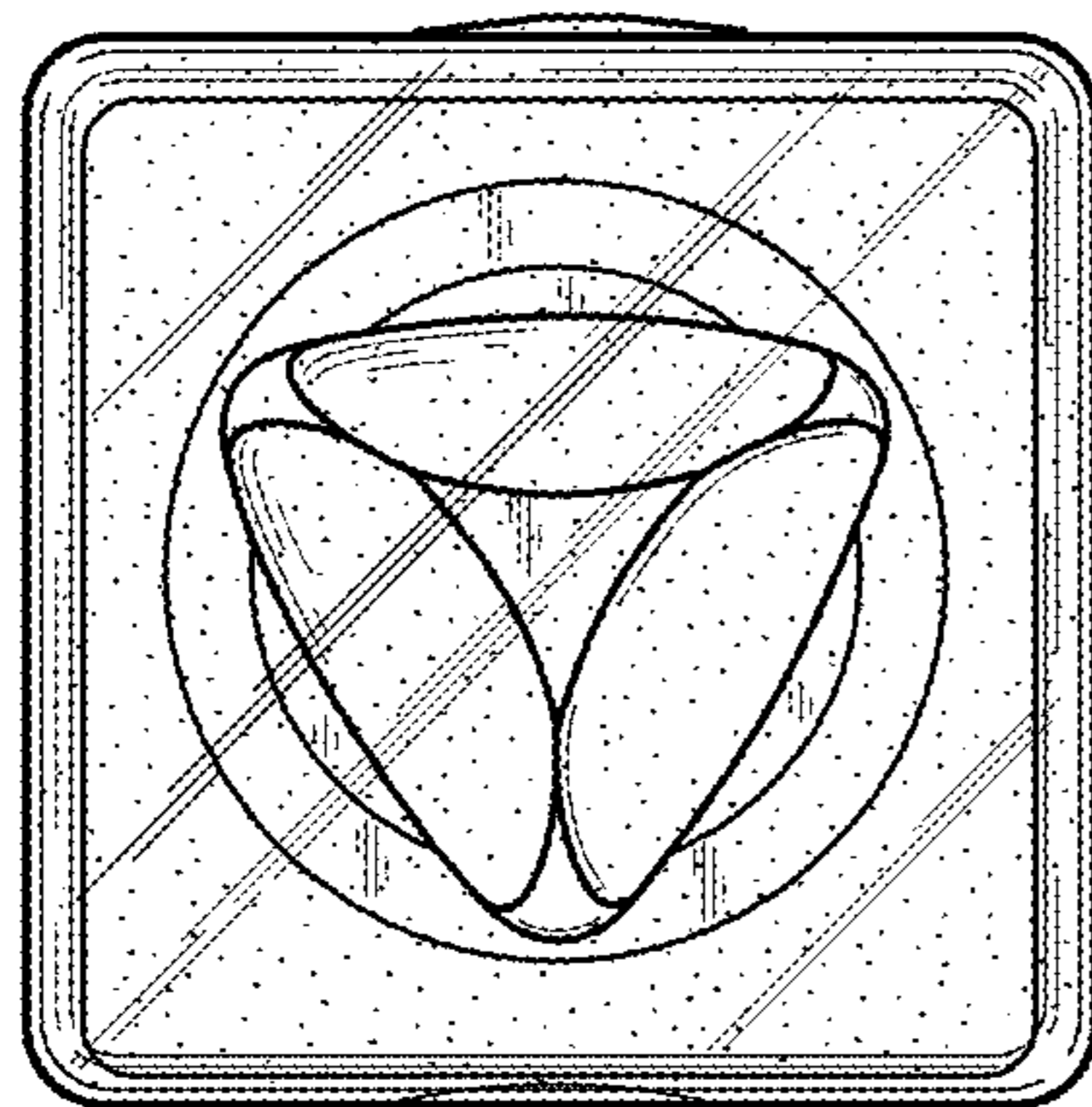

FIG. 6

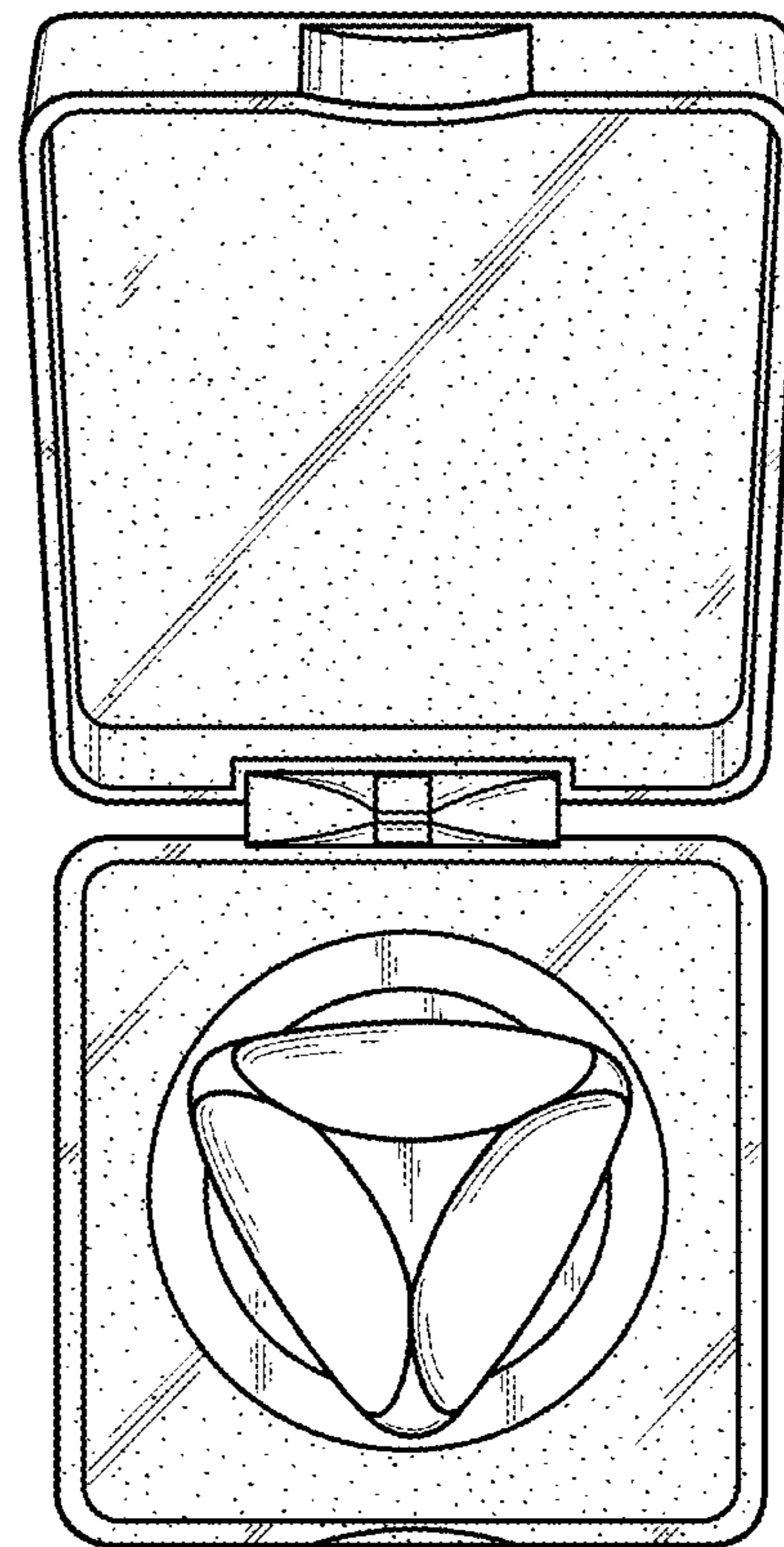



**FIG. 7**



**FIG. 8**



**FIG. 9**