



US00D824219S

(12) **United States Design Patent** (10) **Patent No.:** **US D824,219 S**
Barr (45) **Date of Patent:** **** Jul. 31, 2018**

(54) **COASTER STATE BOTTLE OPENER**

(71) Applicant: **Caffeinate Labs, Inc.**, Portland, ME
(US)

(72) Inventor: **Nathan Gregg Barr**, Portland, ME
(US)

(73) Assignee: **Caffeinate Labs, Inc.**

(**) Term: **15 Years**

(21) Appl. No.: **29/590,166**

(22) Filed: **Jan. 8, 2017**

(51) **LOC (11) Cl.** **09-03**

(52) **U.S. Cl.**
USPC **D7/624.1**; D8/18

(58) **Field of Classification Search**
USPC D7/624.1-624.3, 625; D8/18, 19, 33-43;
D9/649

CPC A47B 91/12; A47G 28/03; A47G 23/03;
B67B 7/00; B67B 7/14; B67B 7/18;
B67B 7/20; B67B 7/24; B67B 7/44
See application file for complete search history.

(56) **References Cited**

U.S. PATENT DOCUMENTS

- 2,570,954 A * 10/1951 Kasman A47G 23/03
131/231
- 2,910,769 A * 11/1959 Schneider B67B 7/44
30/1.5
- D237,771 S * 11/1975 Oropeza D6/695
- D270,511 S * 9/1983 Friedman D7/624.1
- D289,364 S * 4/1987 Bass D8/34
- D343,207 S * 1/1994 Adell D21/371
- D434,279 S * 11/2000 Bushey D7/624.1
- D504,290 S * 4/2005 Lockhart D8/38
- D601,861 S * 10/2009 Richardson D7/624.1
- D603,658 S * 11/2009 Burns D7/624.1
- D635,829 S * 4/2011 Morrish D7/388
- D730,131 S * 5/2015 Cornell D8/19
- D766,687 S * 9/2016 Arcomano D8/18
- D771,451 S * 11/2016 DiCarlo D8/18
- D782,890 S * 4/2017 Palomino D8/18

- D787,904 S * 5/2017 Dahl D8/17
- D800,522 S * 10/2017 Talarico D8/18
- 2017/0295973 A1* 10/2017 Nargi A47G 23/03

FOREIGN PATENT DOCUMENTS

GB 3024500 * 4/2006

OTHER PUBLICATIONS

State Bartool Bottle Opener. Online, published date unknown. Retrieved on Nov. 28, 2017 from URL: <https://practical-american.myshopify.com/collections/open-beer-season/products/50-states-bartool?variant=28703243085>.*

Coaster Bottle Openers. Online, published date unknown. Retrieved on Nov. 28, 2017 from URL: <https://practical-american.myshopify.com/collections/open-beer-season/products/coaster-openers>.*

Hexagon opener, Hoegaarden logo beer opener, customize bottle opener. Online, published date unknown. Retrieved on Nov. 28, 2017 from URL: https://www.alibaba.com/product-detail/Hexagon-opener-Hoegaarden-logo-beer-opener_555883943.html.*

* cited by examiner

Primary Examiner — Vy N Koenig

Assistant Examiner — Omeed Agilee

(74) *Attorney, Agent, or Firm* — McInnes & McLane LLP

(57) **CLAIM**

The ornamental design for a coaster state bottle opener, as shown and described.

DESCRIPTION

- FIG. 1 is a front elevation view of a first embodiment of a coaster state bottle opener;
- FIG. 2 is a top plan view thereof, the bottom view being a mirror image thereof;
- FIG. 3 is a rear elevation view thereof;
- FIG. 4 is a left side elevation view thereof, the right side being a mirror image thereof;
- FIG. 5 is a front perspective view thereof;

(Continued)

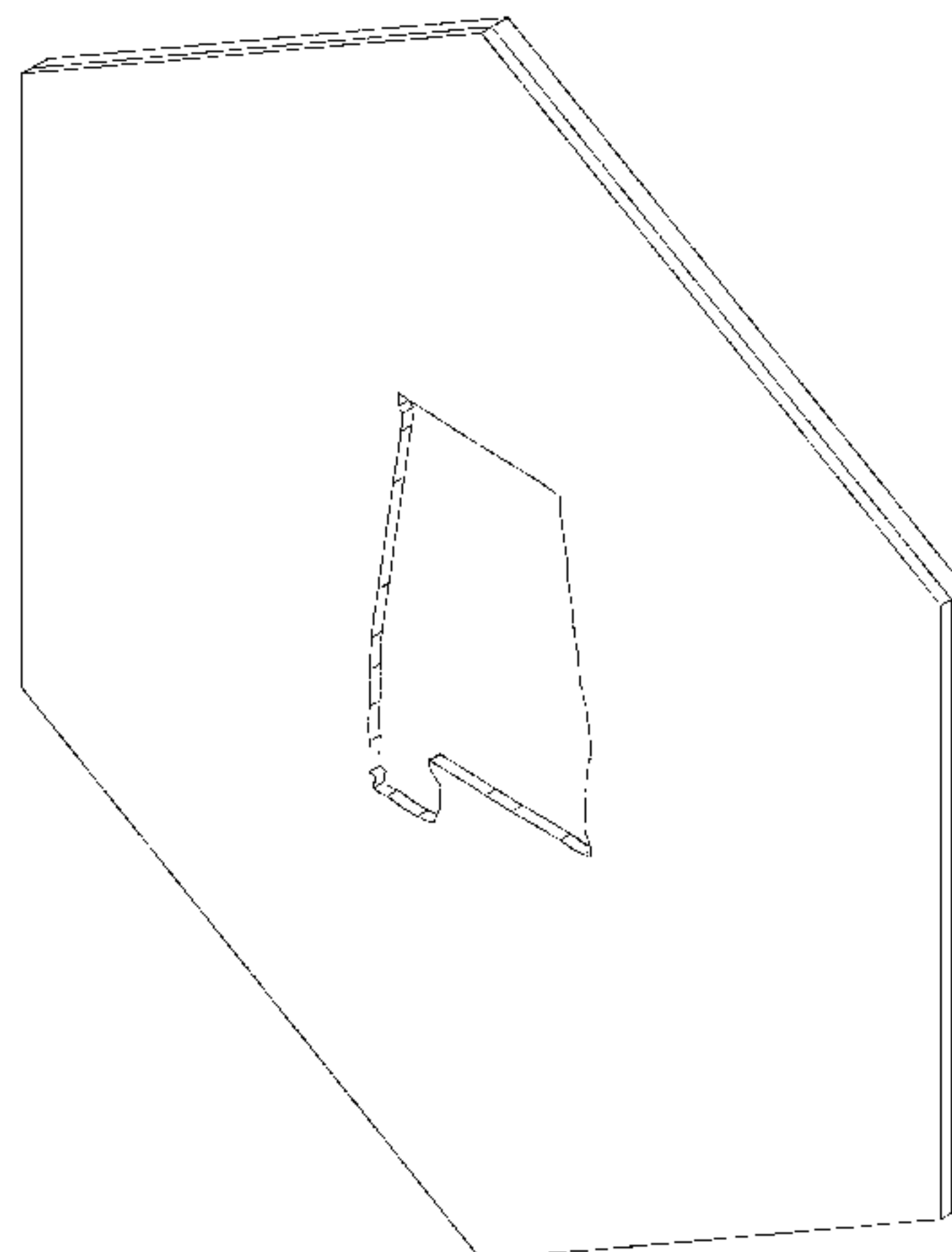
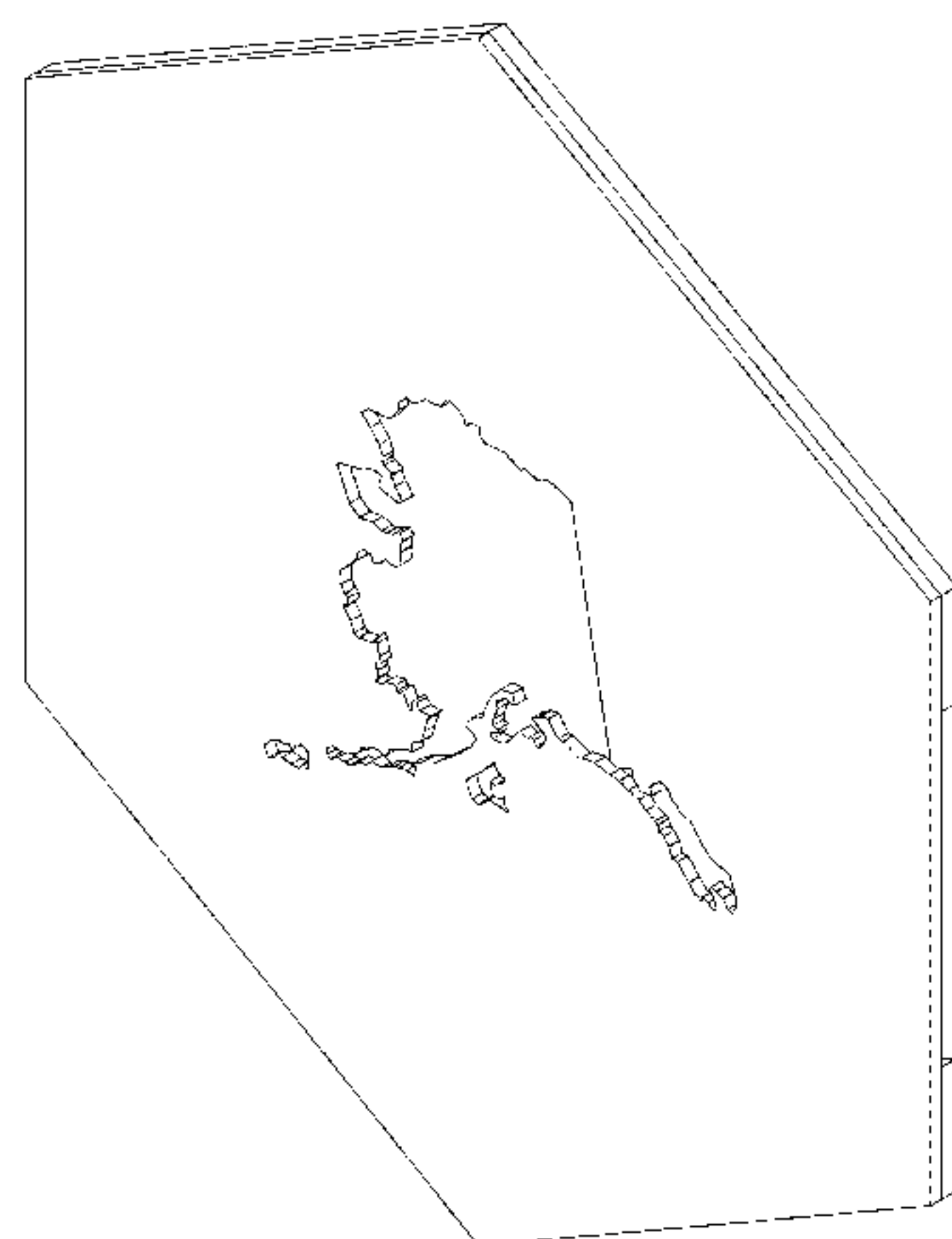

FIG. 245 is a front perspective view thereof;
FIG. 246 is a front elevation view of a fiftieth embodiment of a coaster state bottle opener;
FIG. 247 is a top plan view thereof, the bottom view being a mirror image thereof;
FIG. 248 is a rear elevation view thereof;
FIG. 249 is a left side elevation view thereof, the right side being a mirror image thereof;
FIG. 250 is a front perspective view thereof;
FIG. 251 is a front elevation view of a fifty-first embodiment of a coaster state bottle opener;
FIG. 252 is a top plan view thereof, the bottom view being a mirror image thereof;

FIG. 253 is a rear elevation view thereof;
FIG. 254 is a left side elevation view thereof, the right side being a mirror image thereof;
FIG. 255 is a front perspective view thereof;
FIG. 256 is a front elevation view of a fifty-second embodiment of a coaster state bottle opener;
FIG. 257 is a top plan view thereof, the bottom view being a mirror image thereof;
FIG. 258 is a rear elevation view thereof;
FIG. 259 is a left side elevation view thereof, the right side being a mirror image thereof; and,
FIG. 260 is a front perspective view thereof.

1 Claim, 156 Drawing Sheets

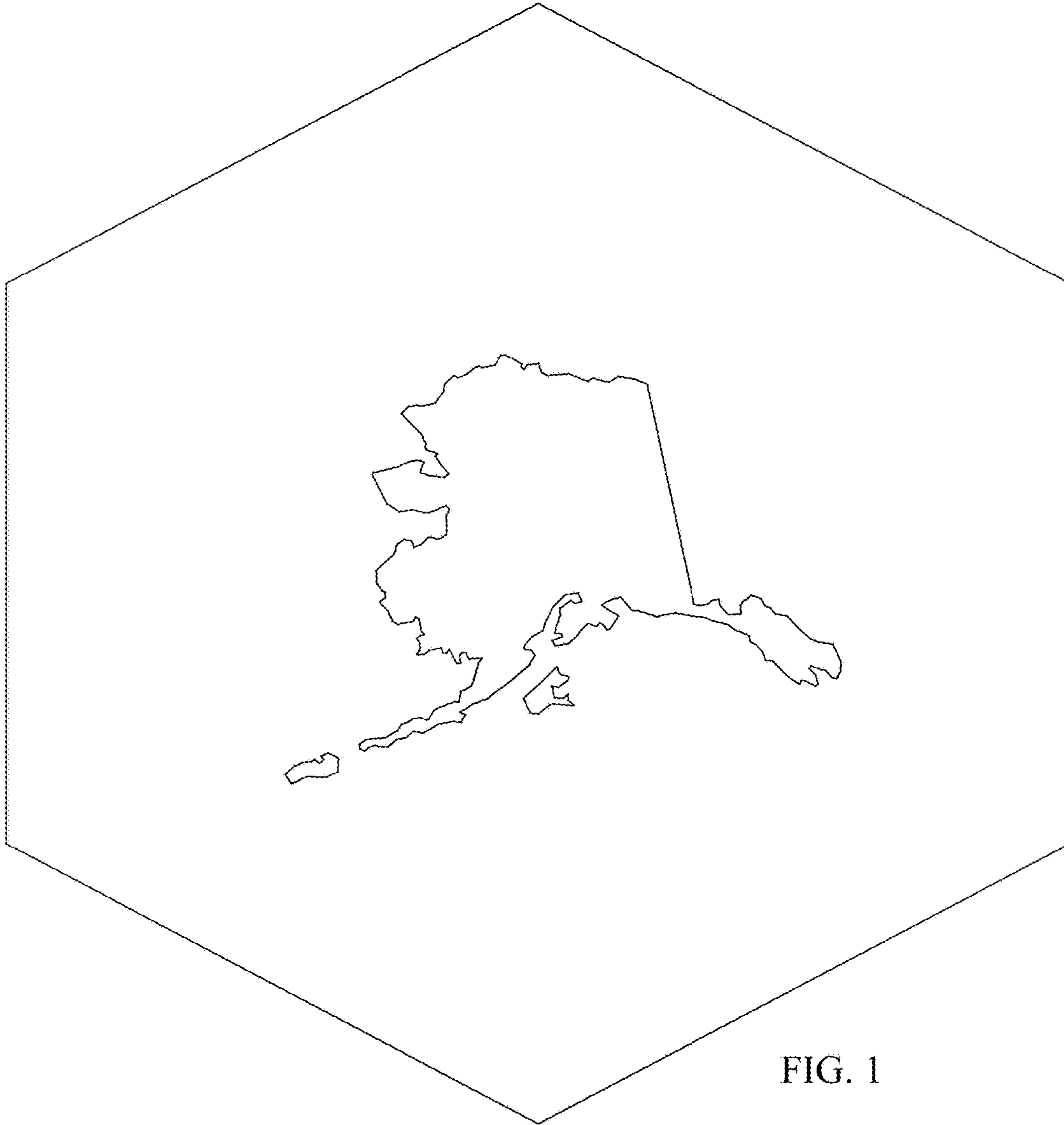

FIG. 1



FIG. 2

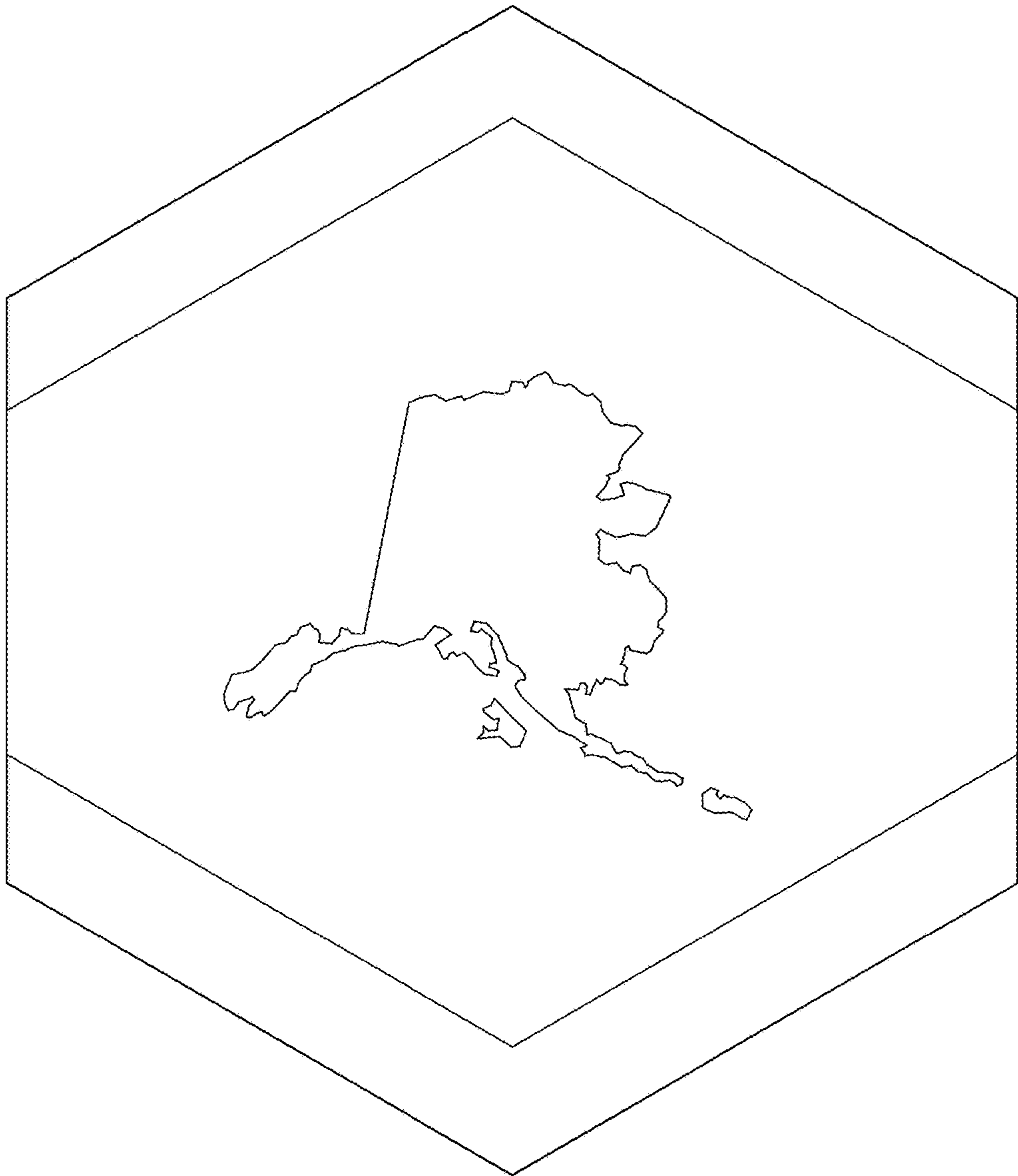

FIG. 3



FIG. 4



FIG. 5

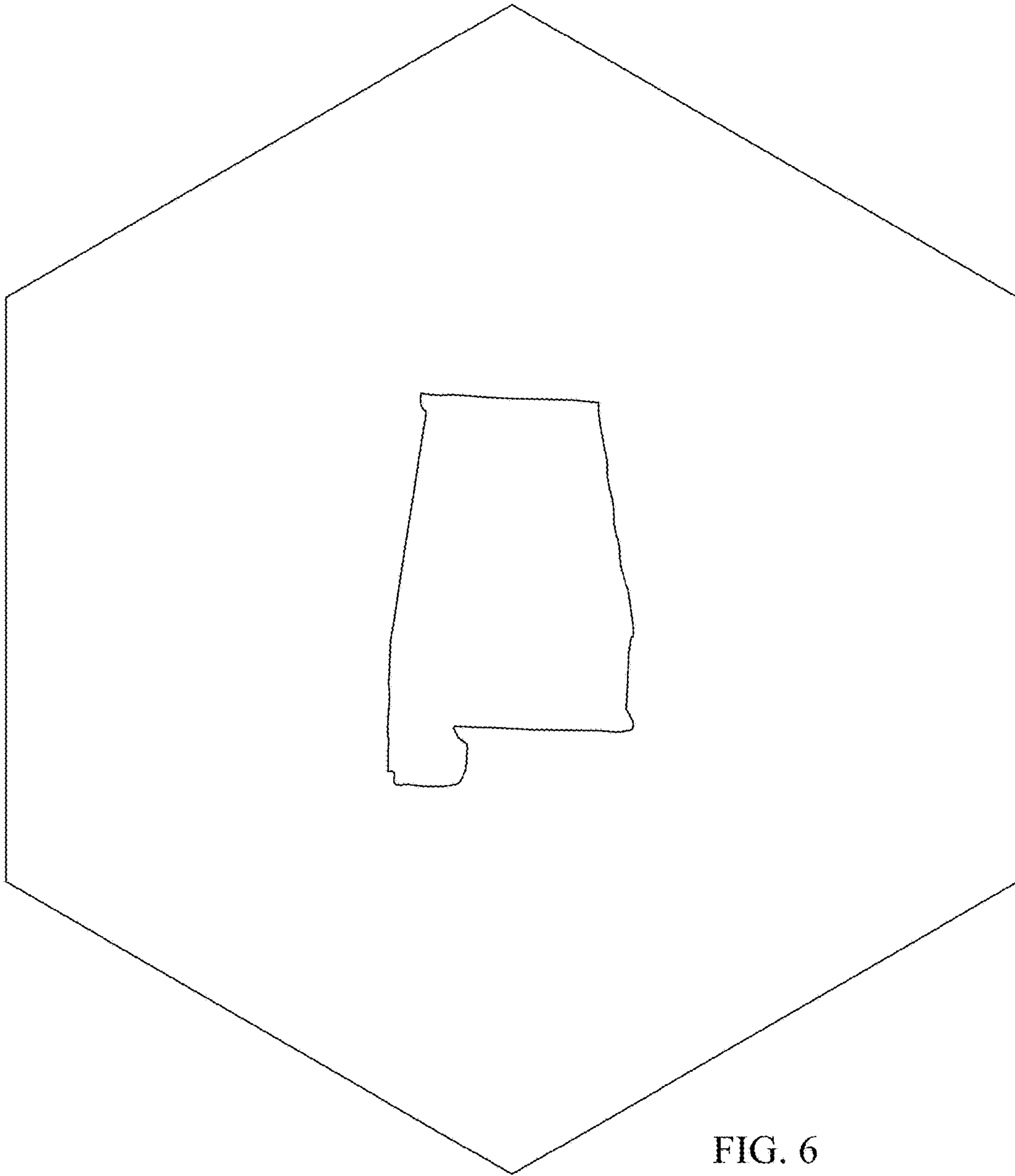

FIG. 6

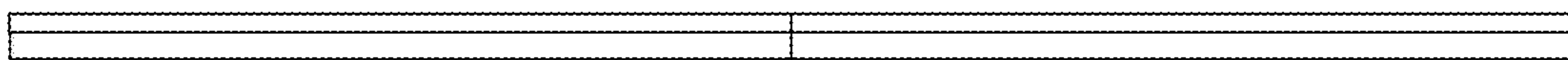

FIG. 7

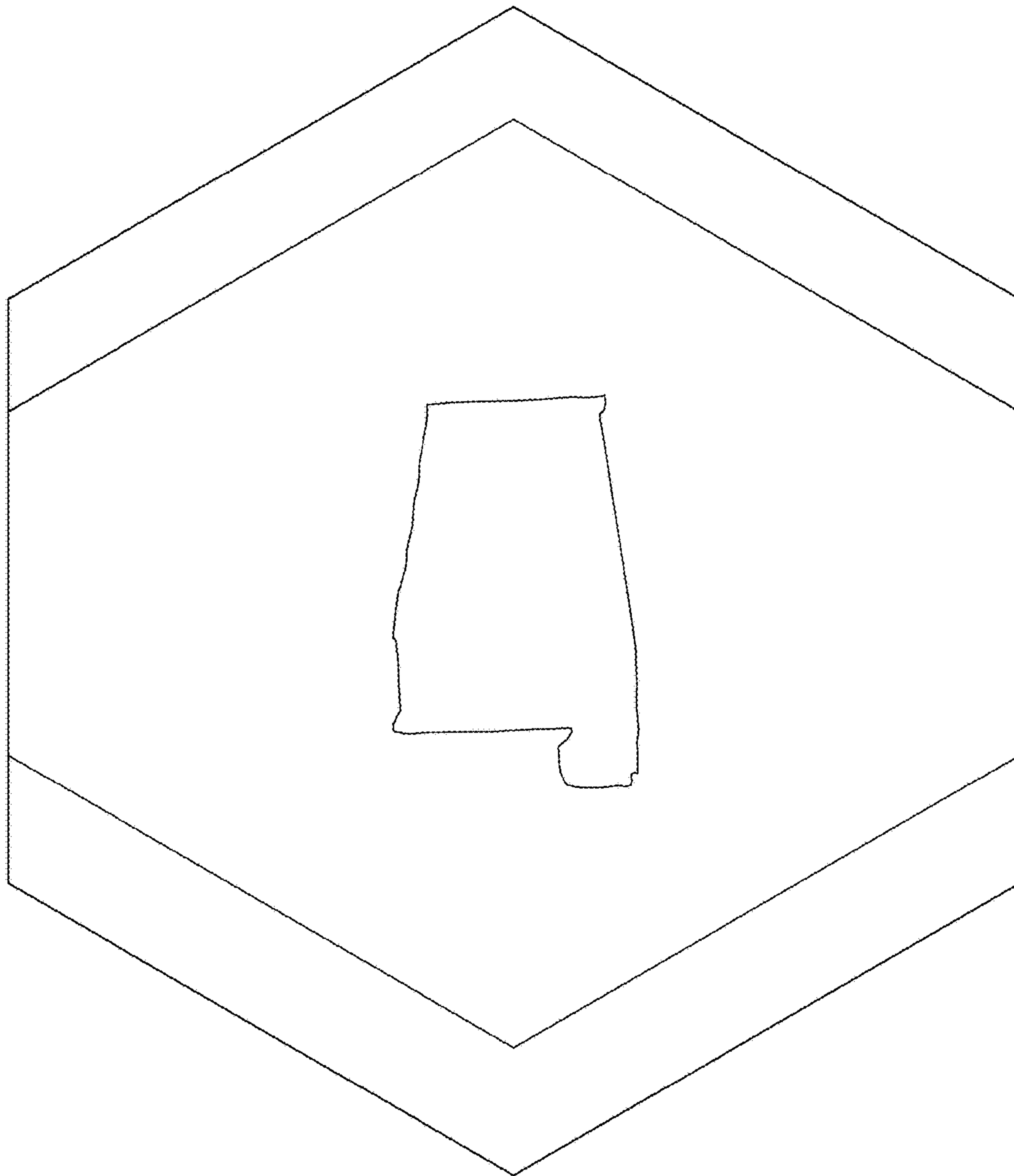

FIG. 8



FIG. 9

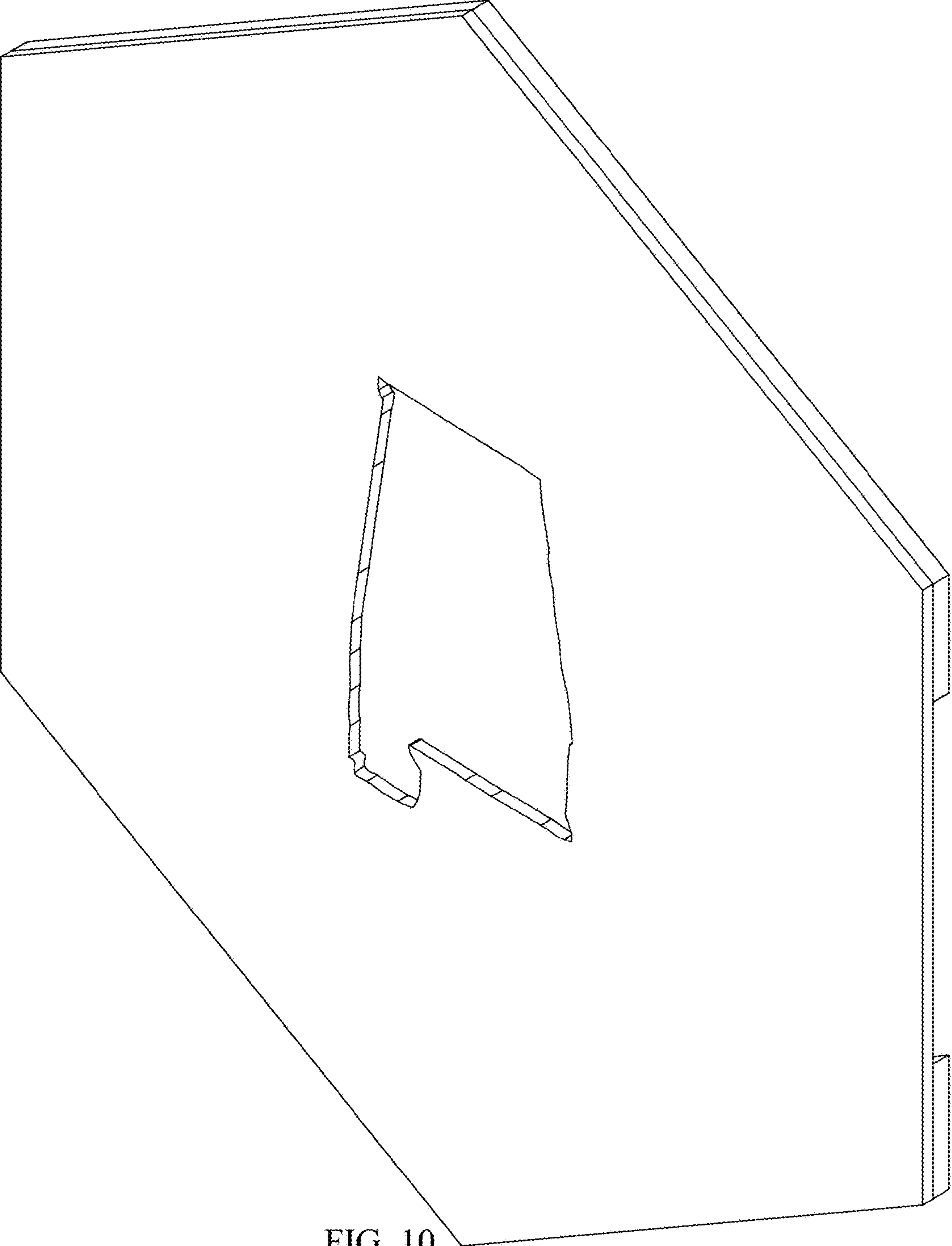

FIG. 10

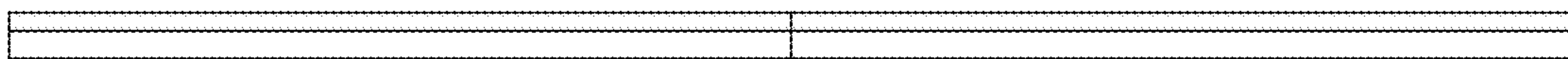
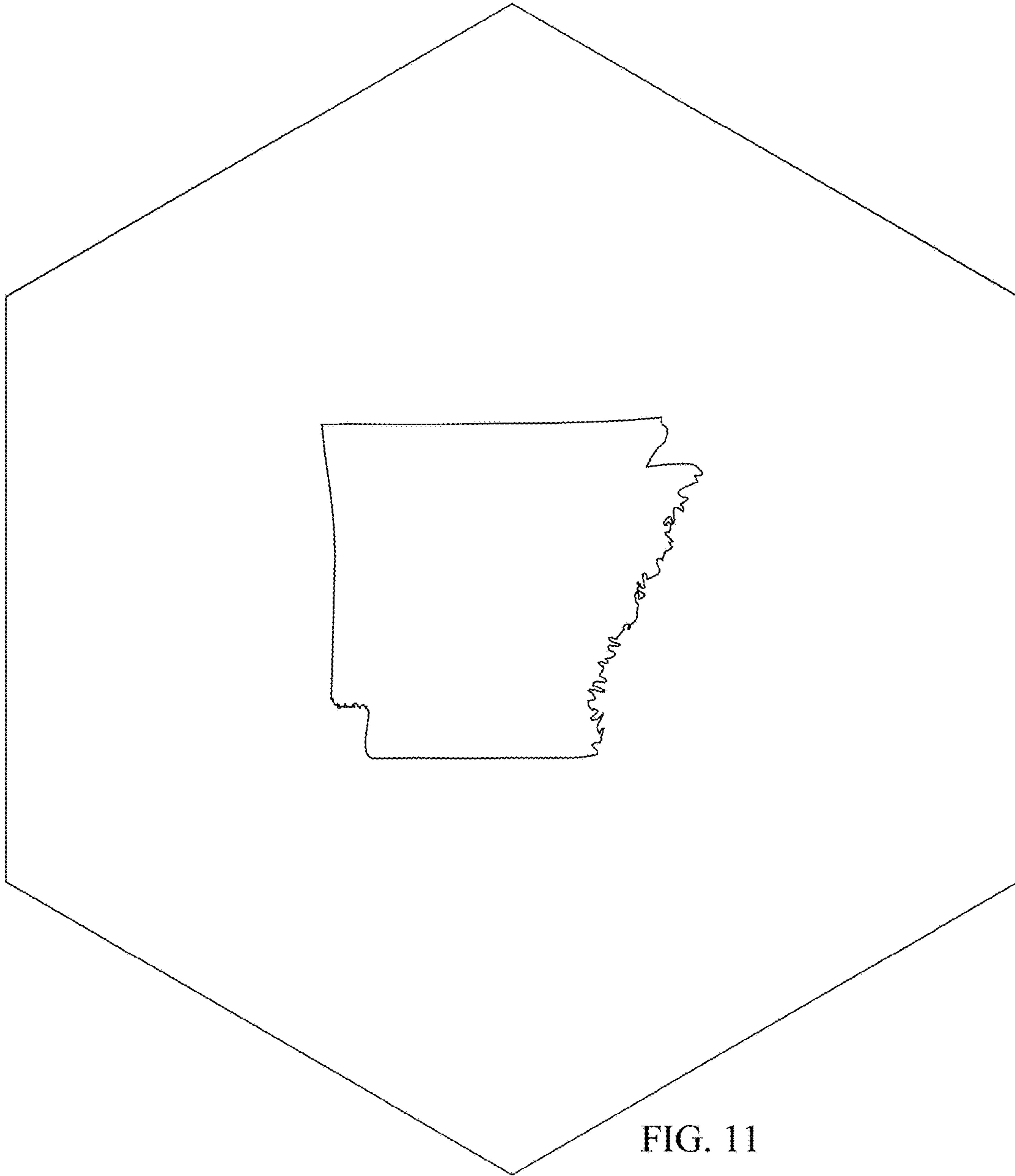

FIG. 12

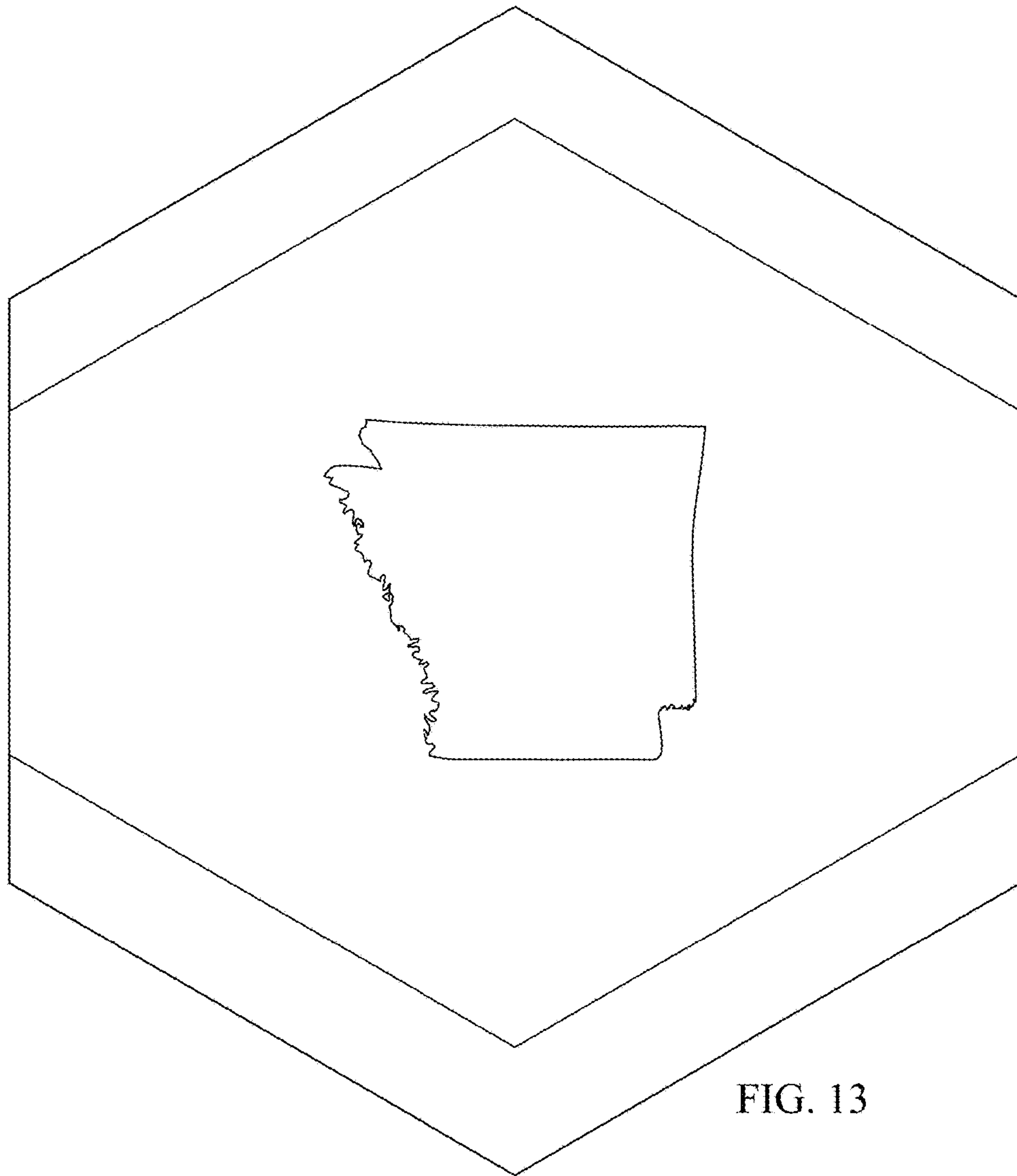

FIG. 13

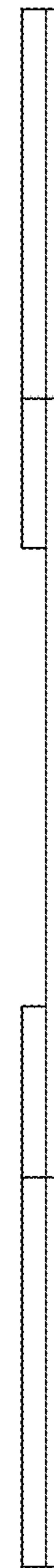

FIG. 14

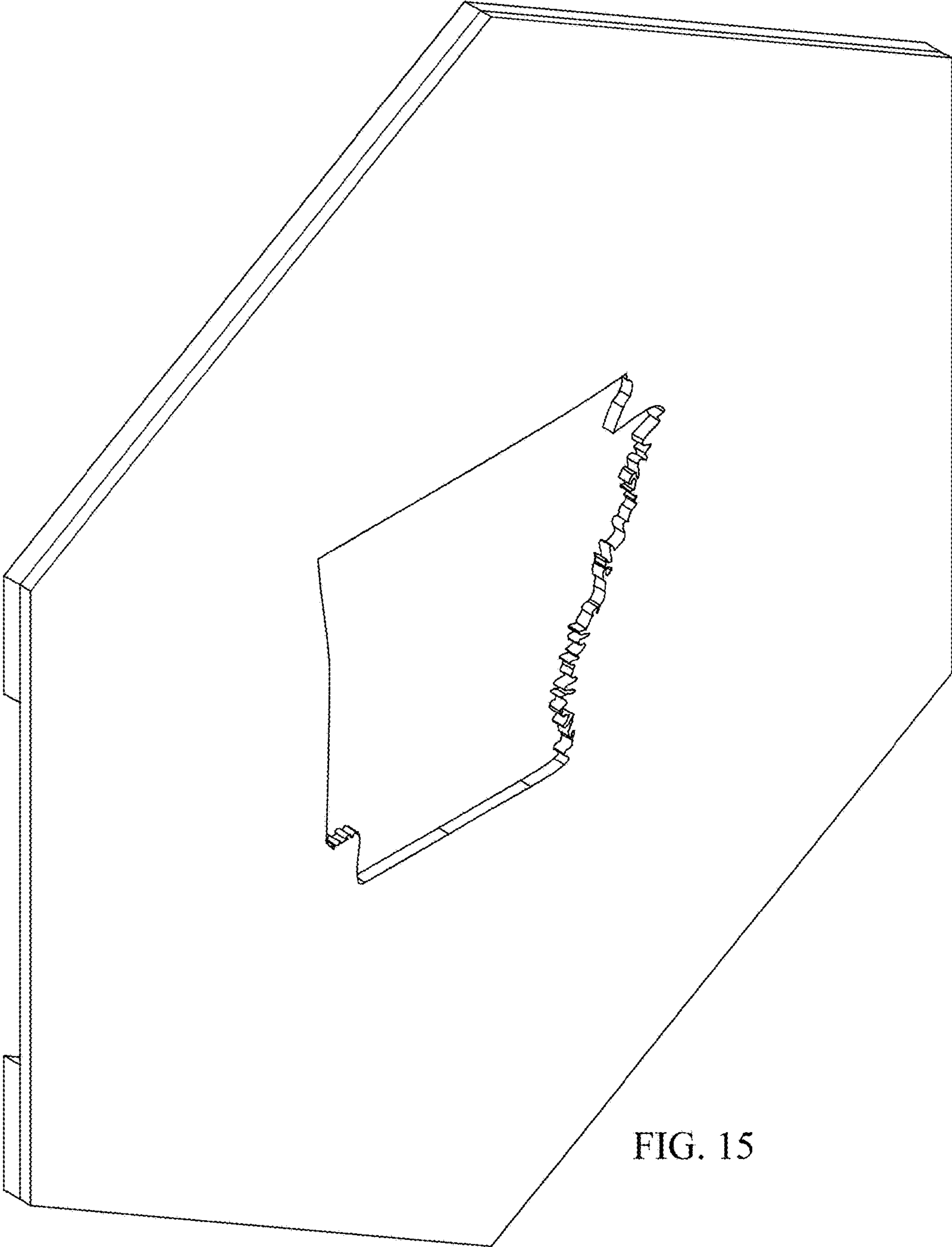

FIG. 15

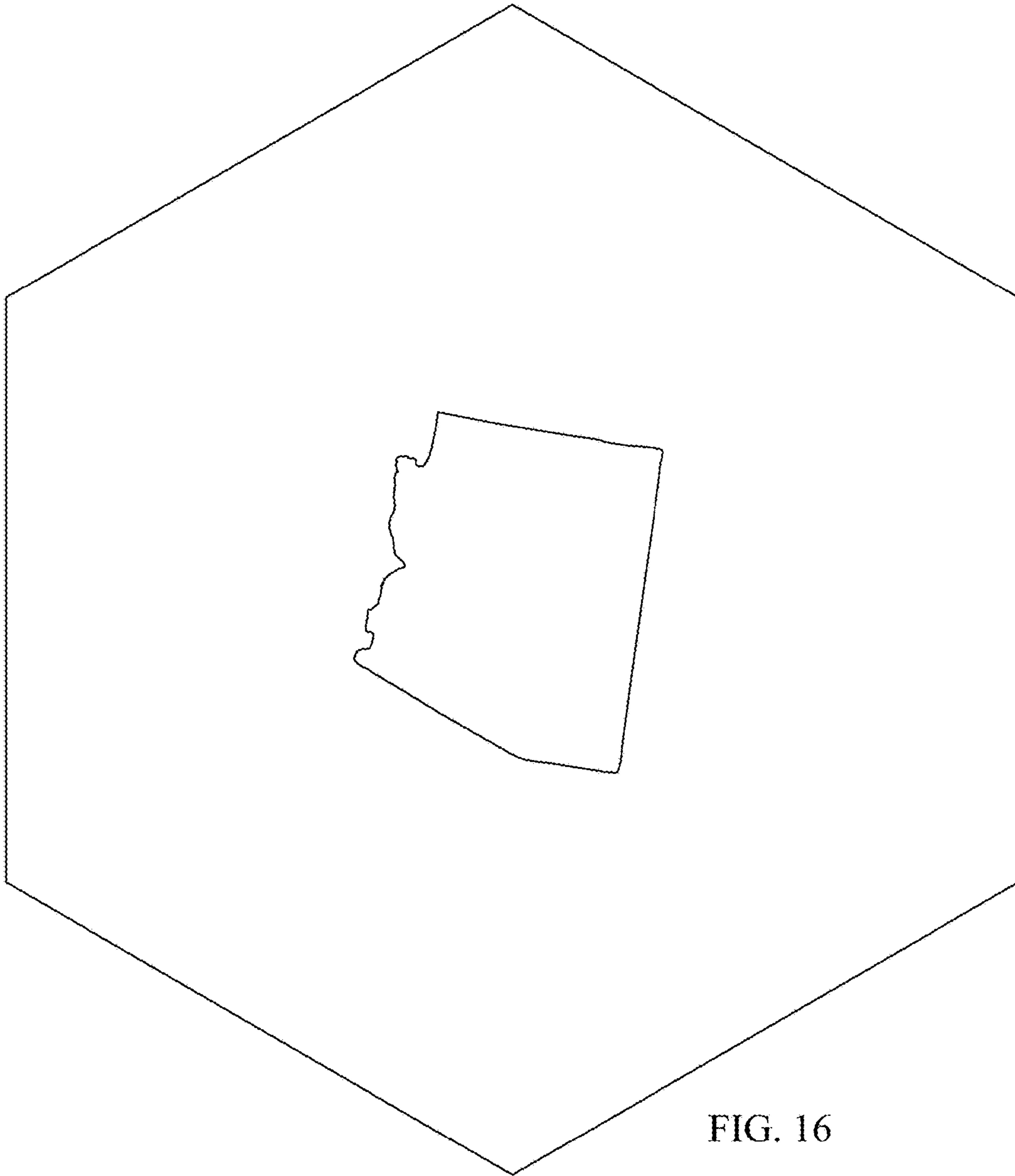

FIG. 16



FIG. 17

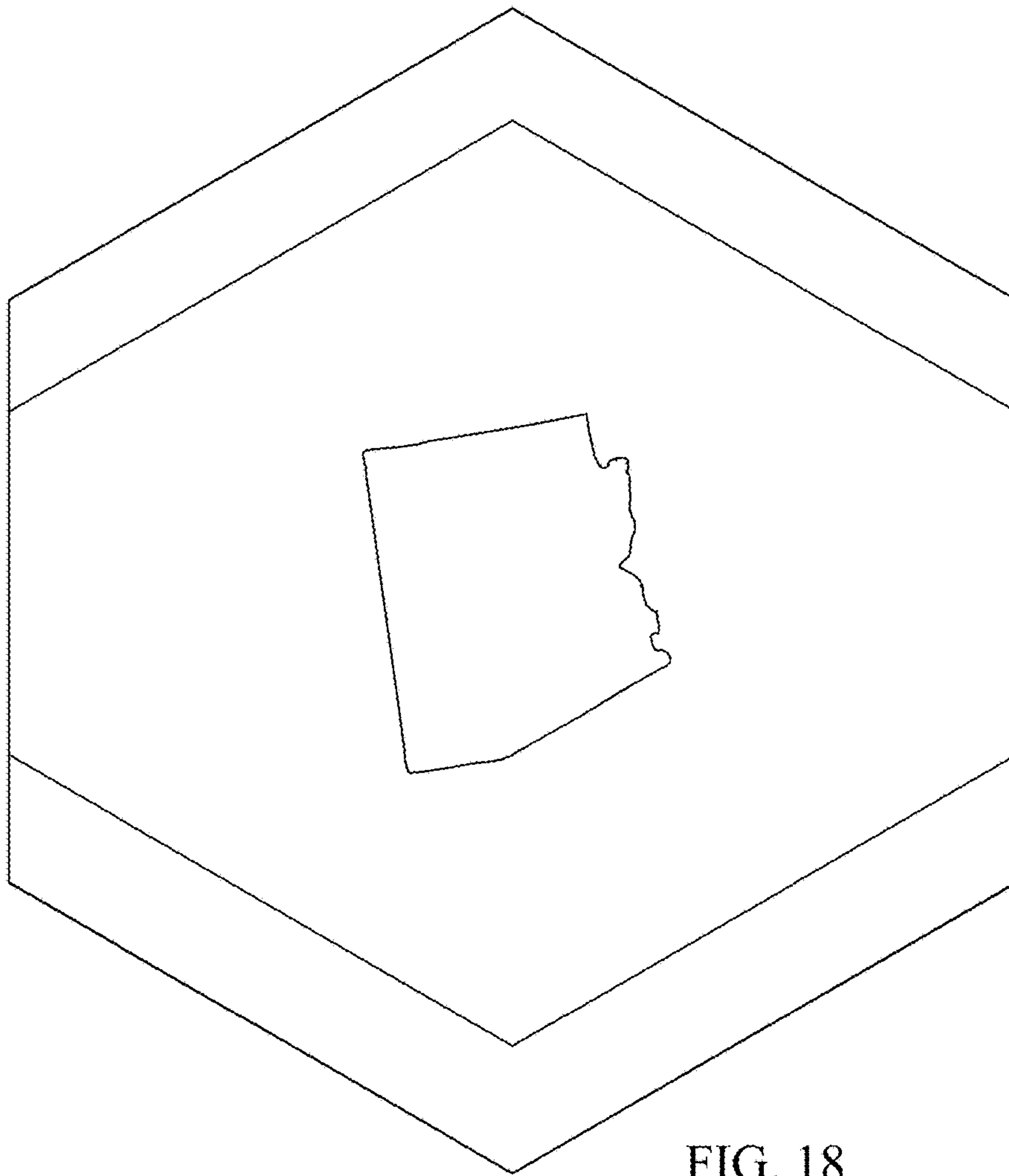

FIG. 18

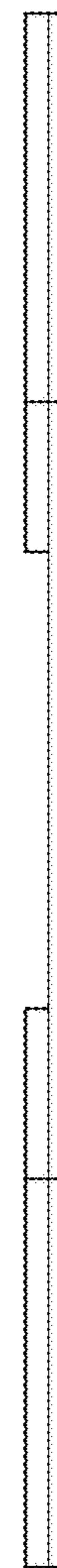

FIG. 19

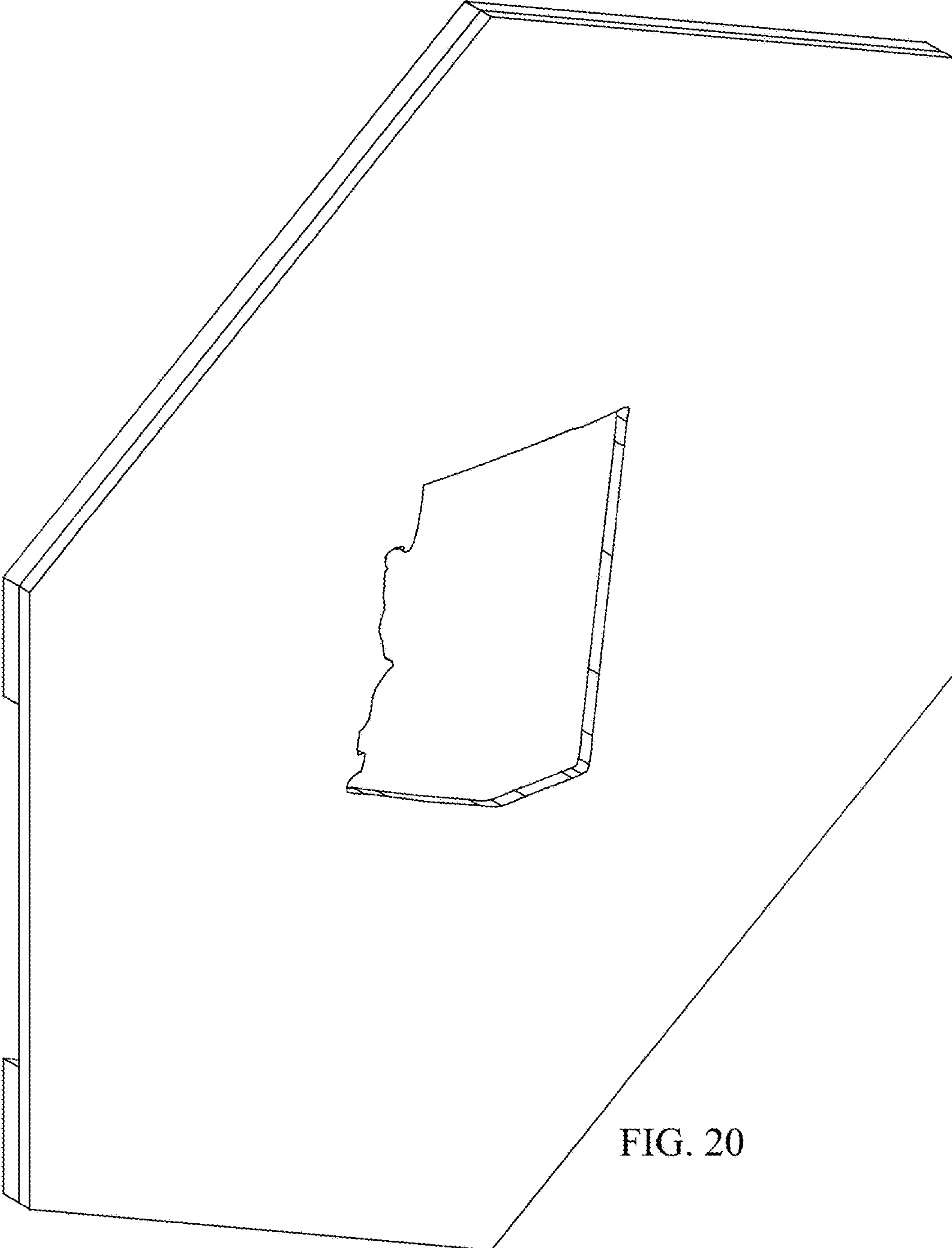

FIG. 20

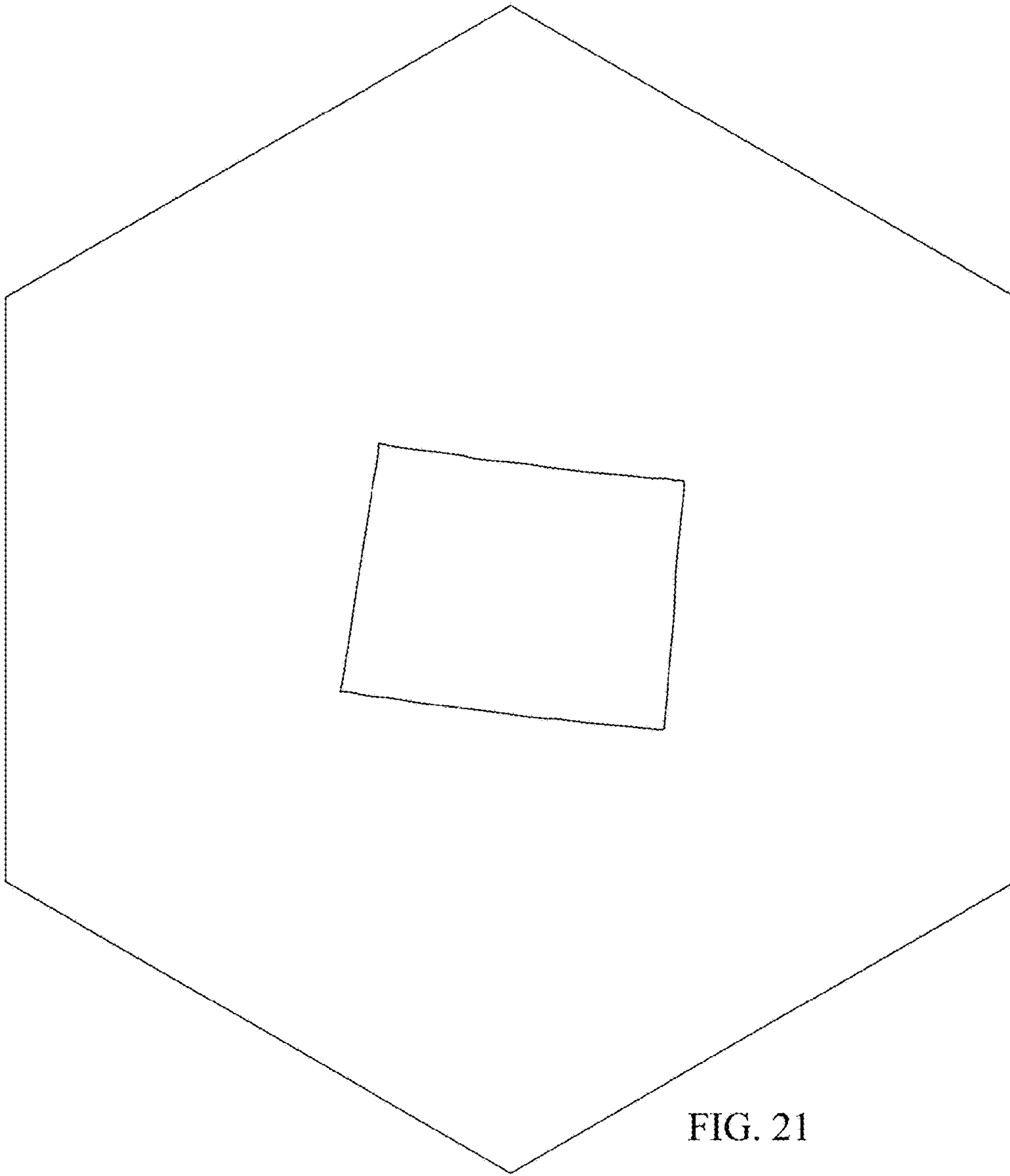

FIG. 21

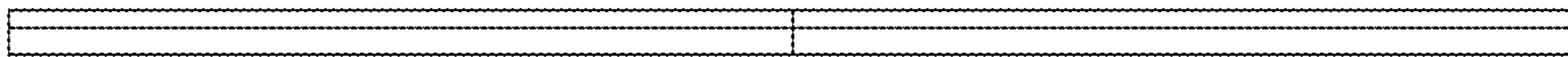

FIG. 22

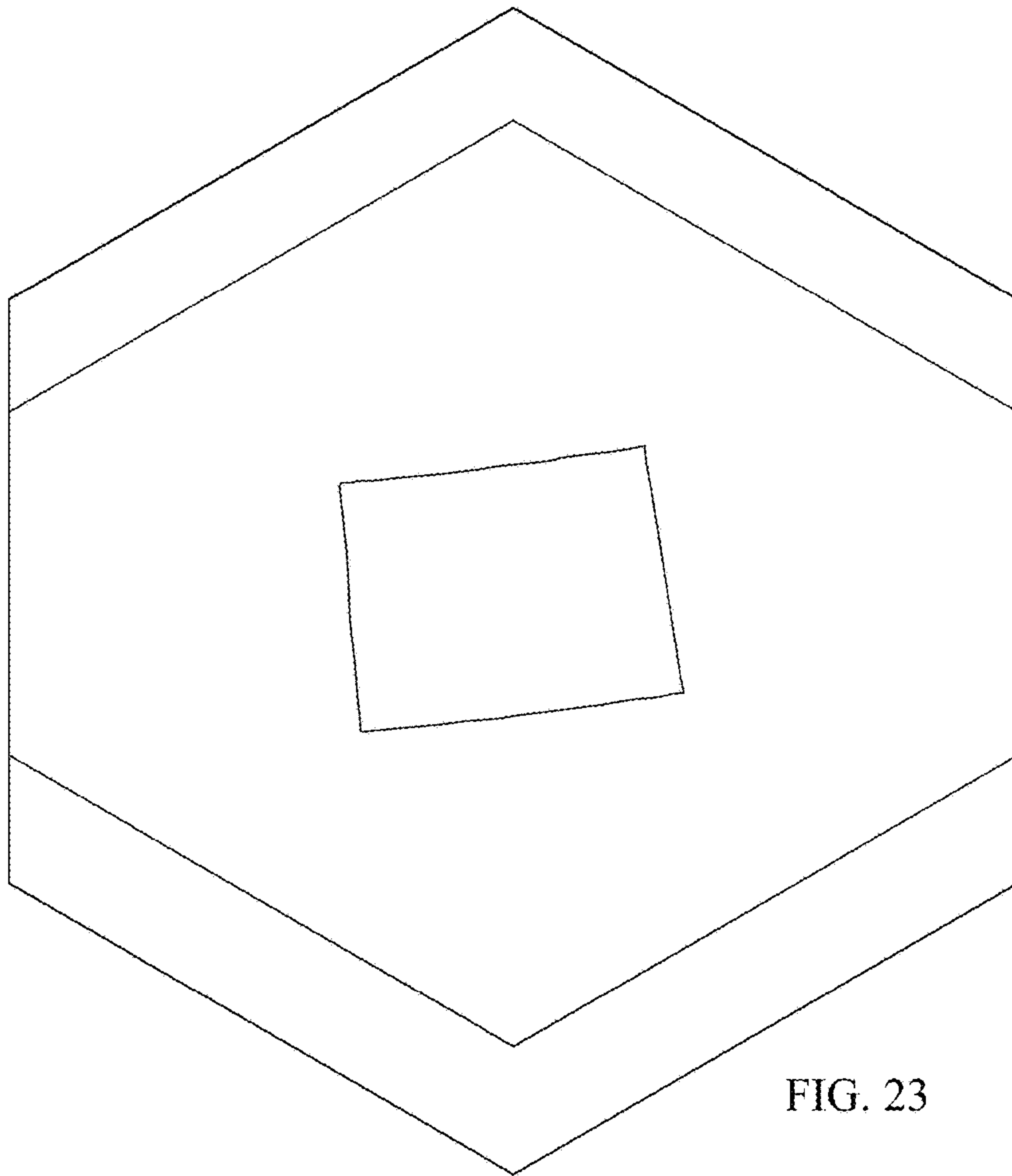

FIG. 23



FIG. 24

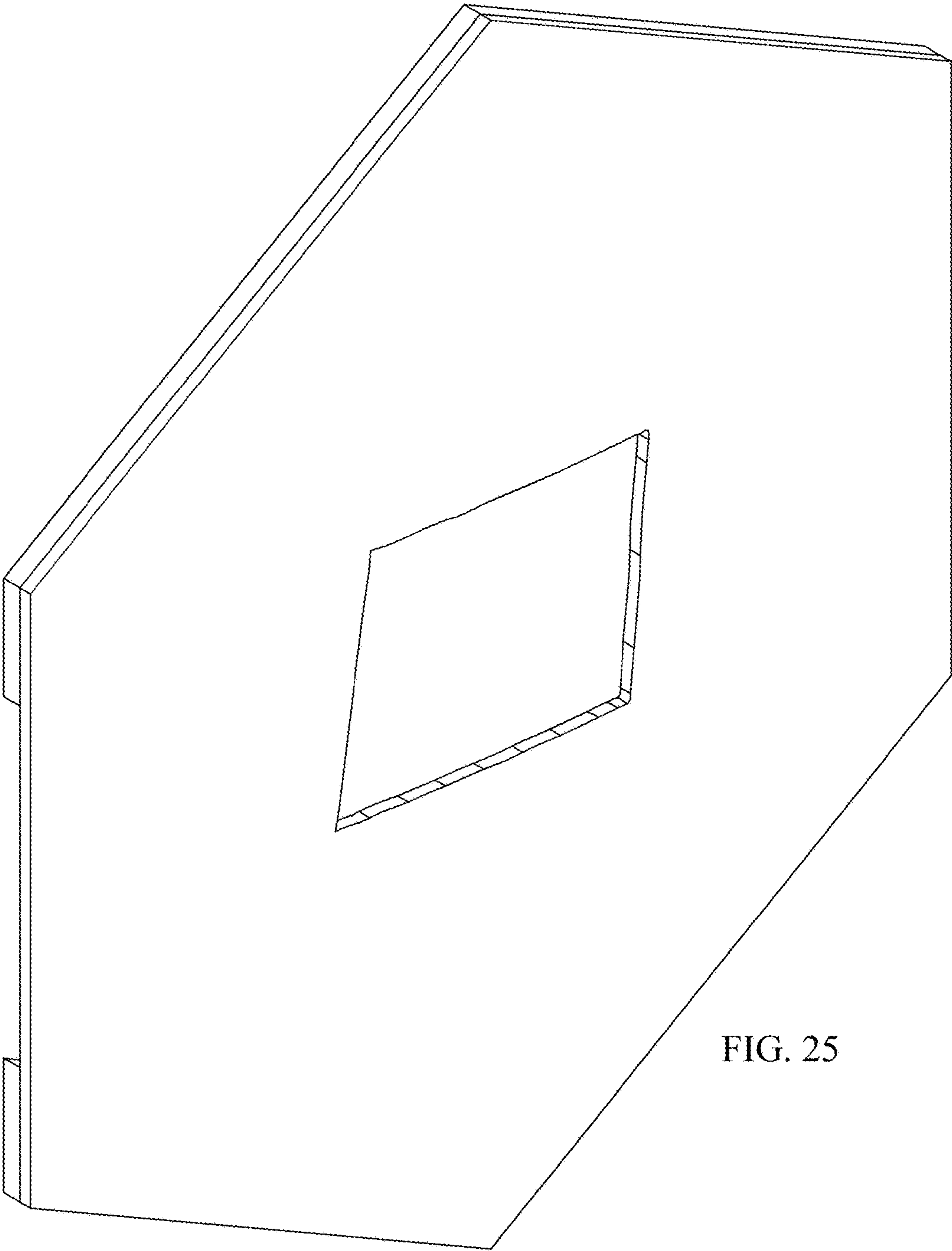

FIG. 25

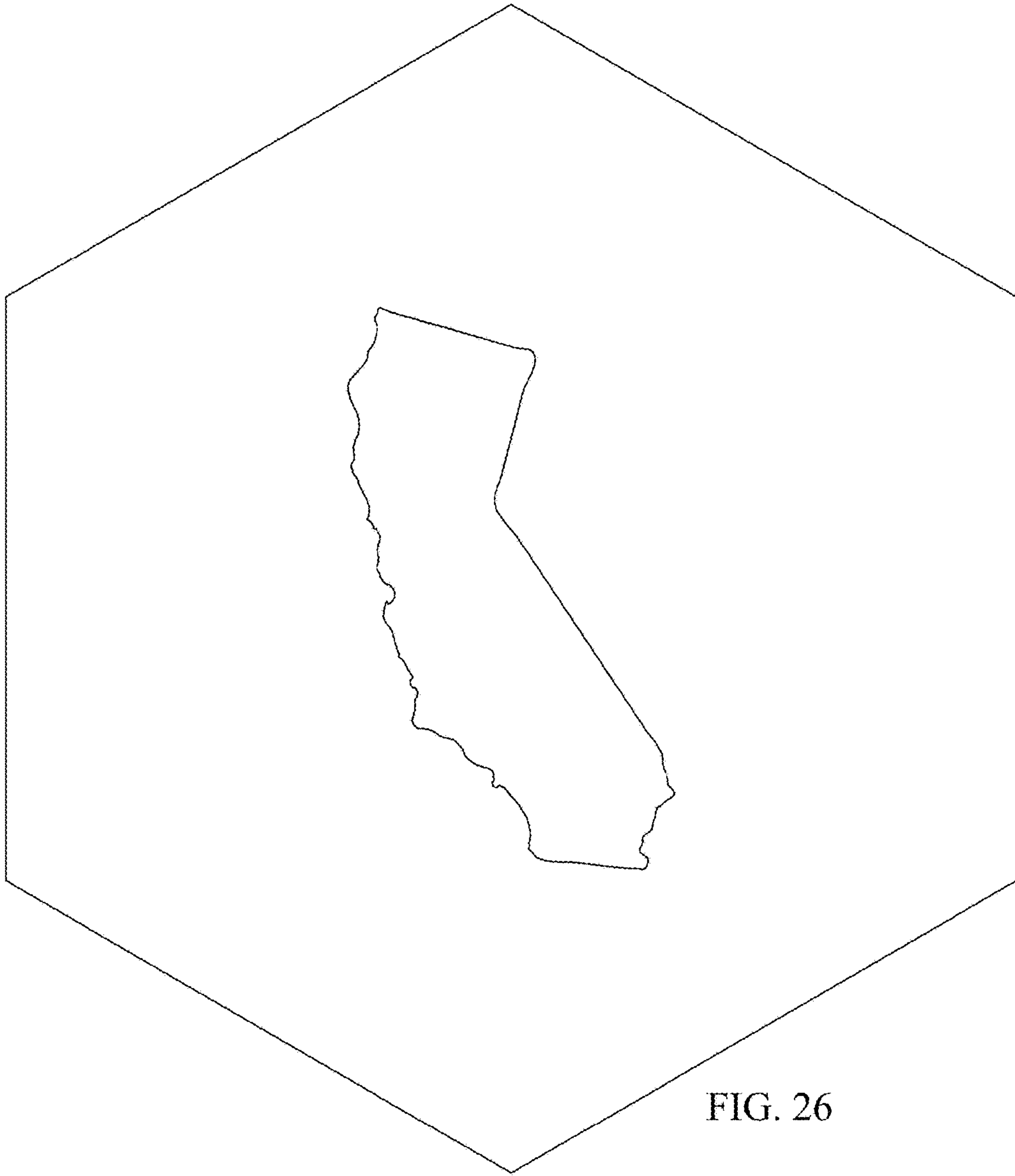

FIG. 26

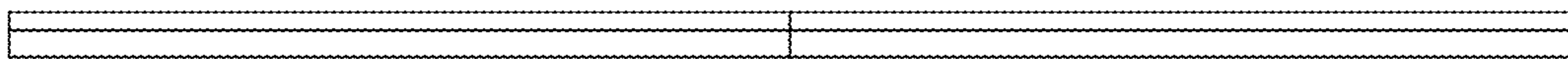

FIG. 27

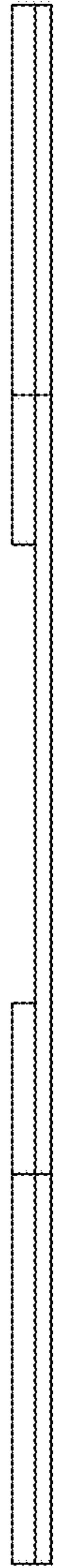

FIG. 28

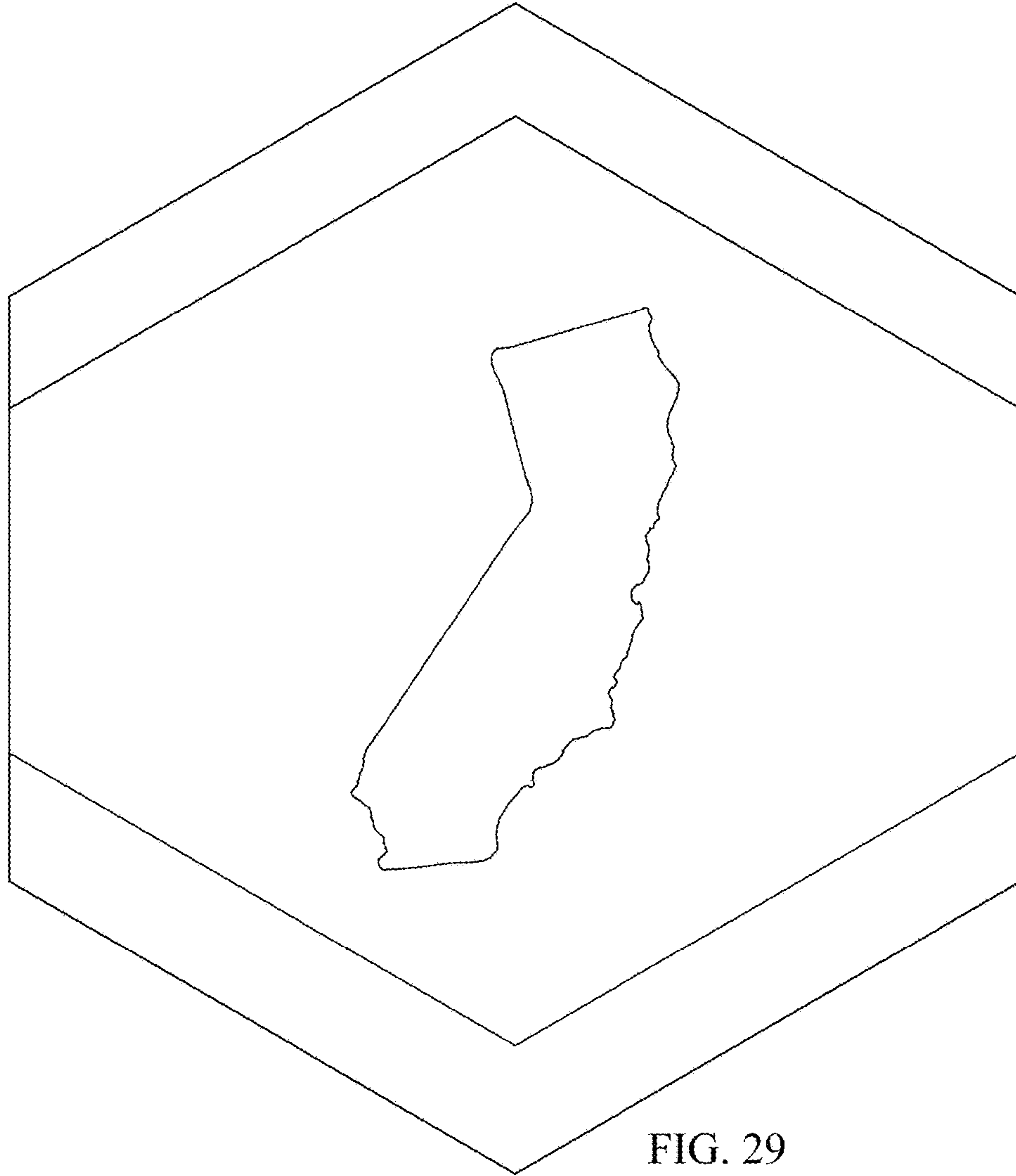

FIG. 29

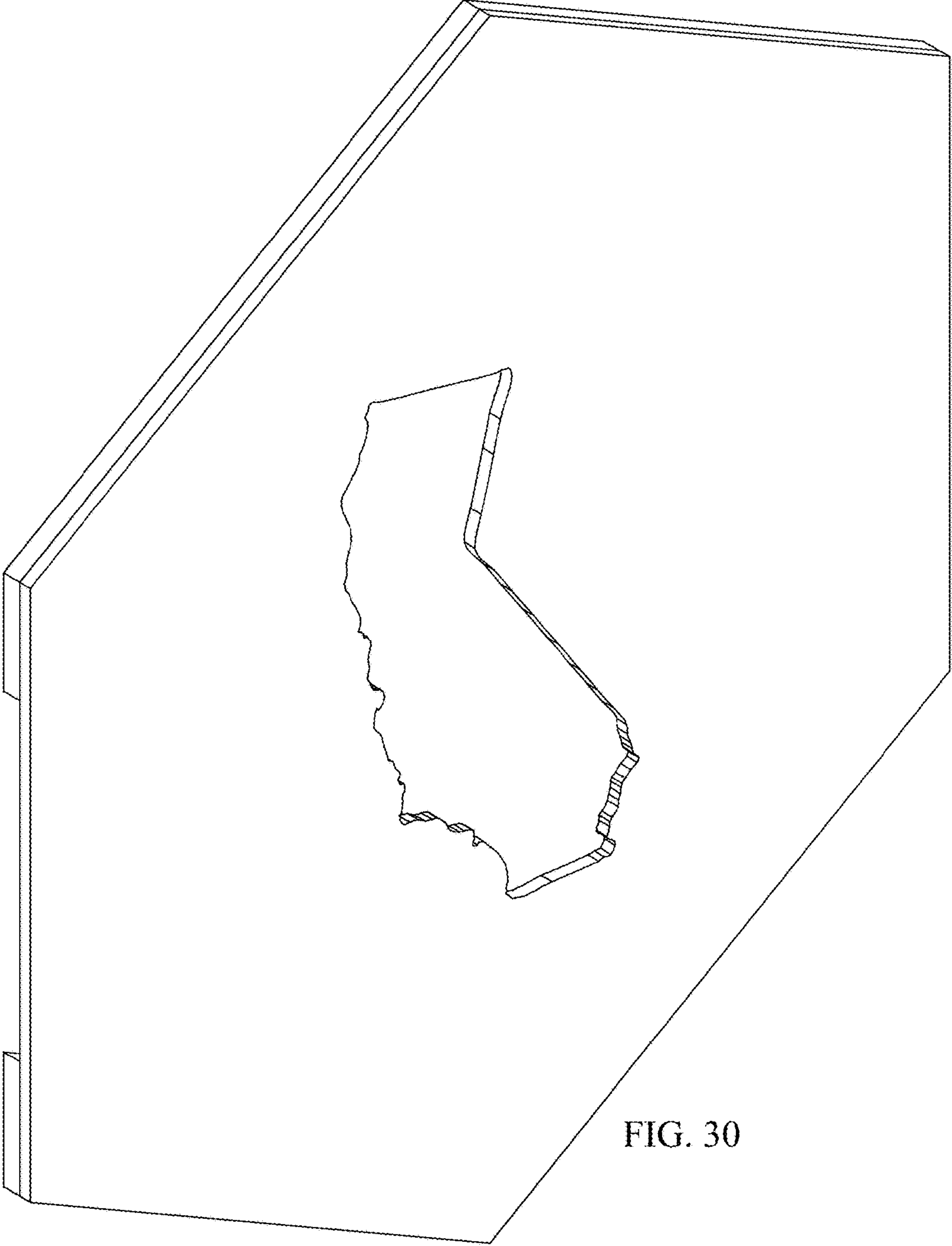

FIG. 30

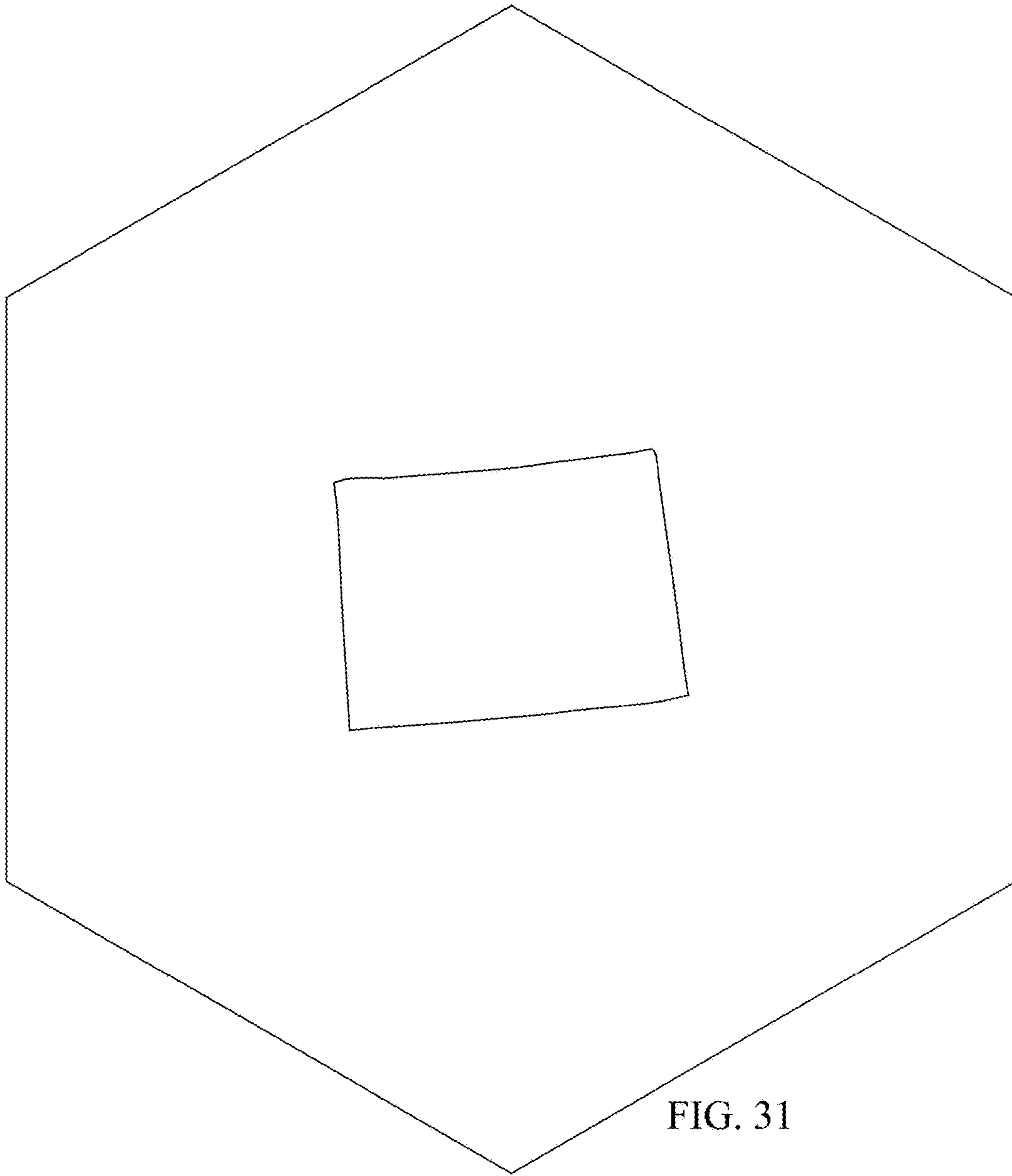

FIG. 31



FIG. 32



FIG. 33

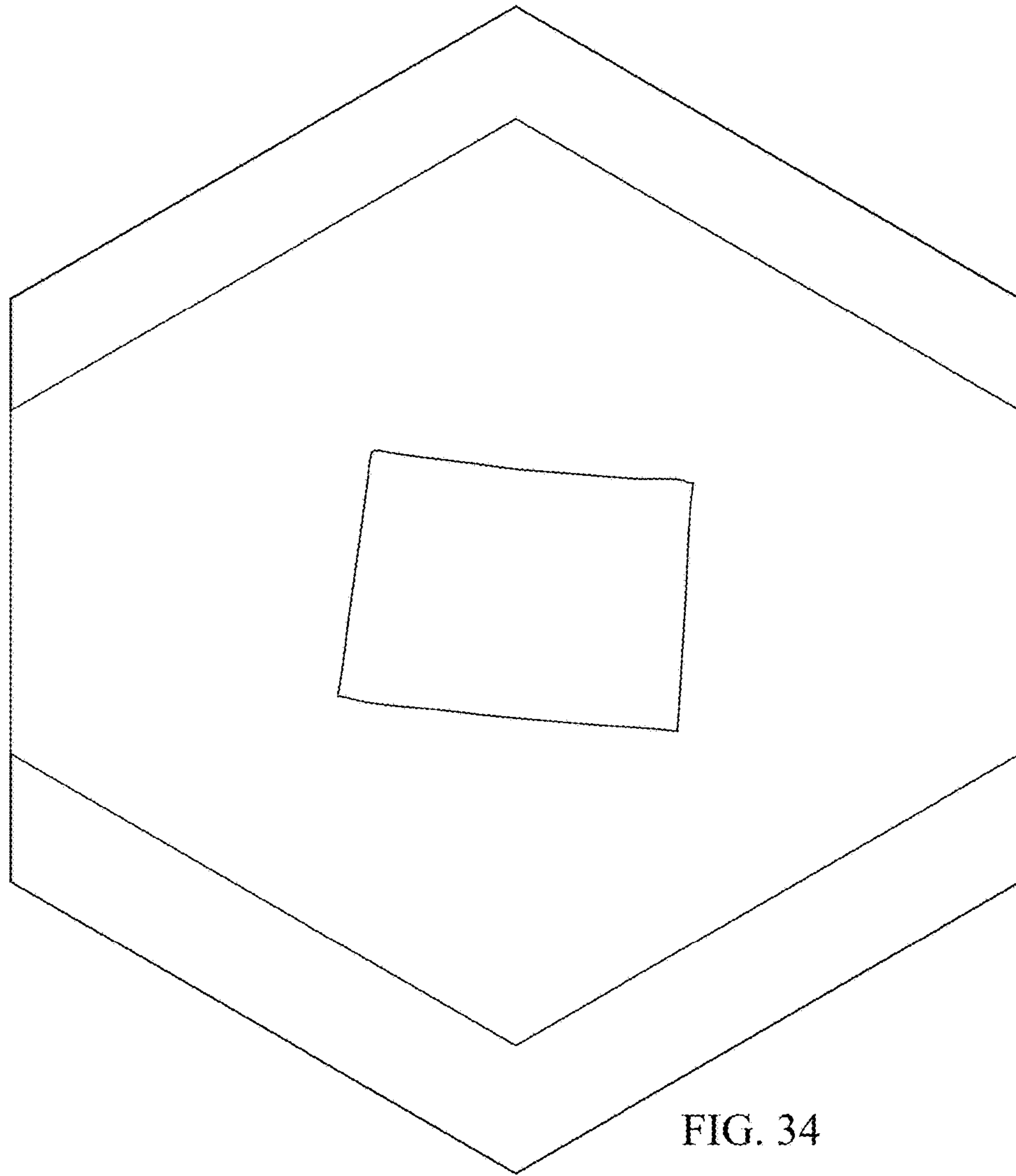

FIG. 34

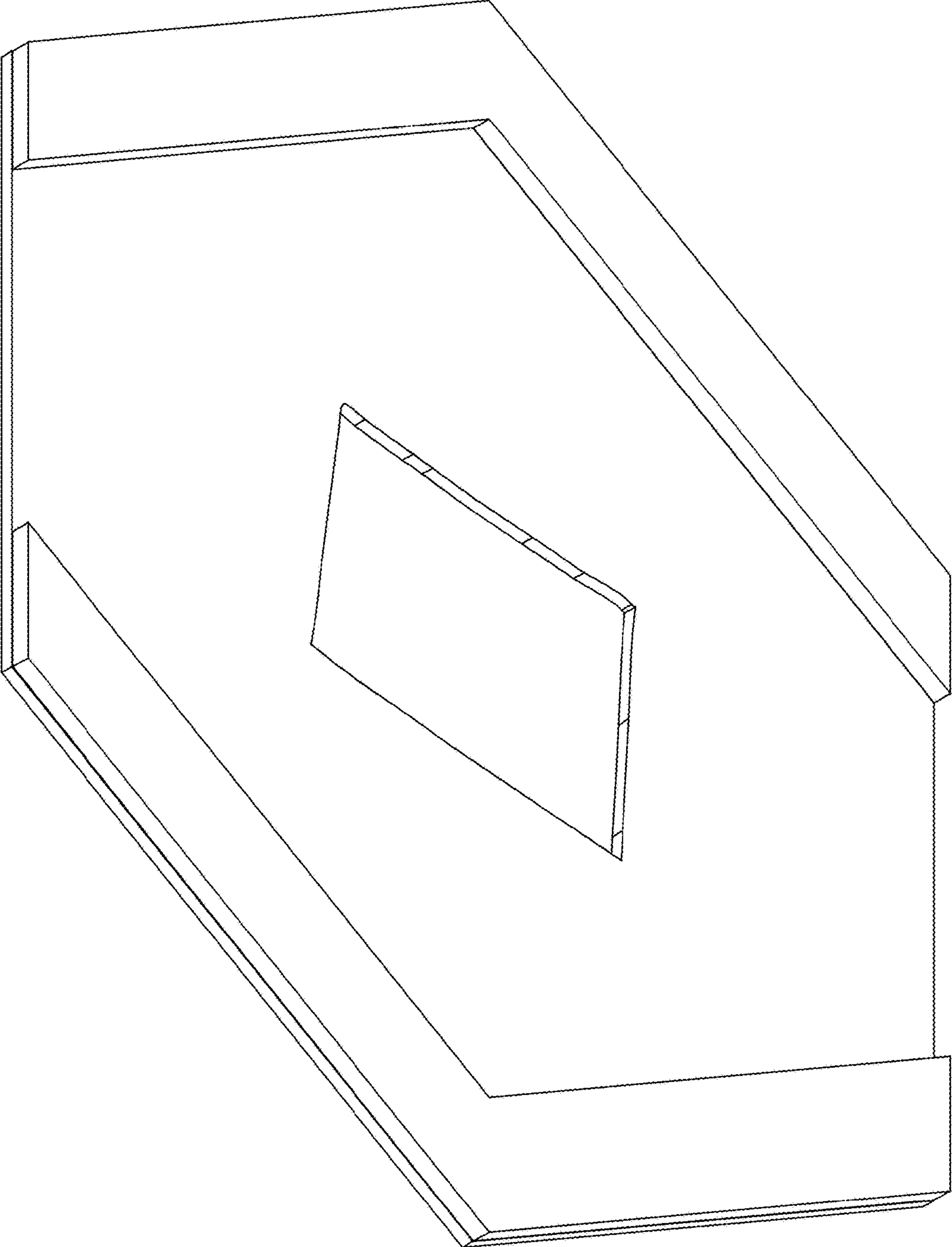

FIG. 35

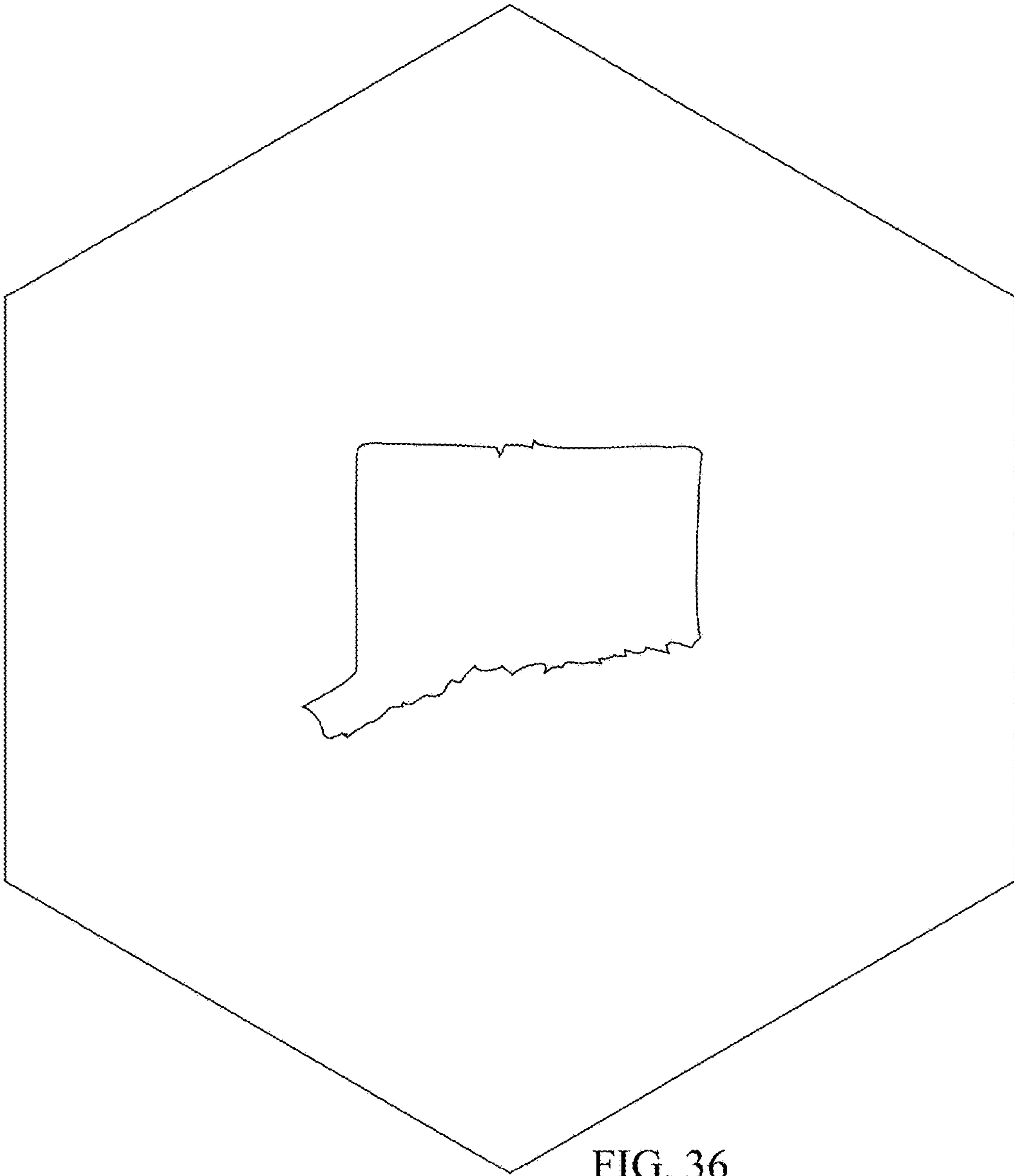

FIG. 36

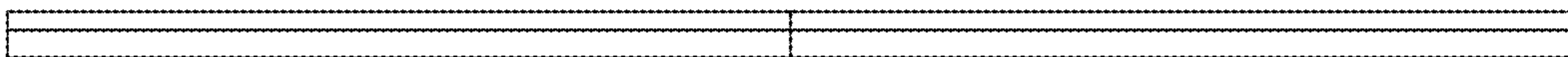

FIG. 37

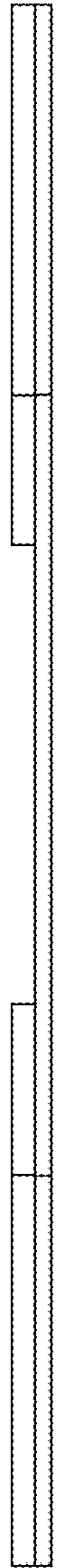

FIG. 38

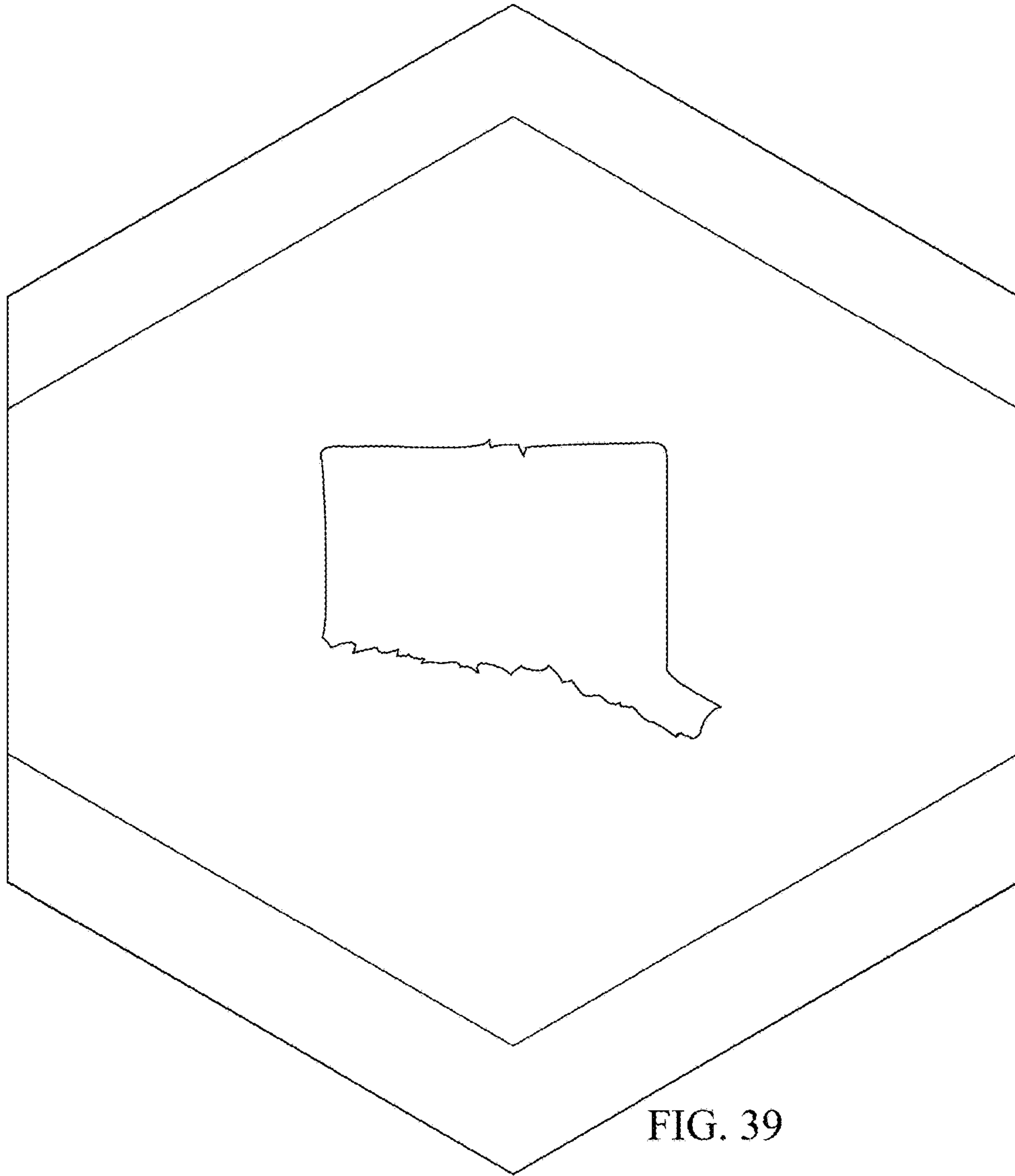

FIG. 39

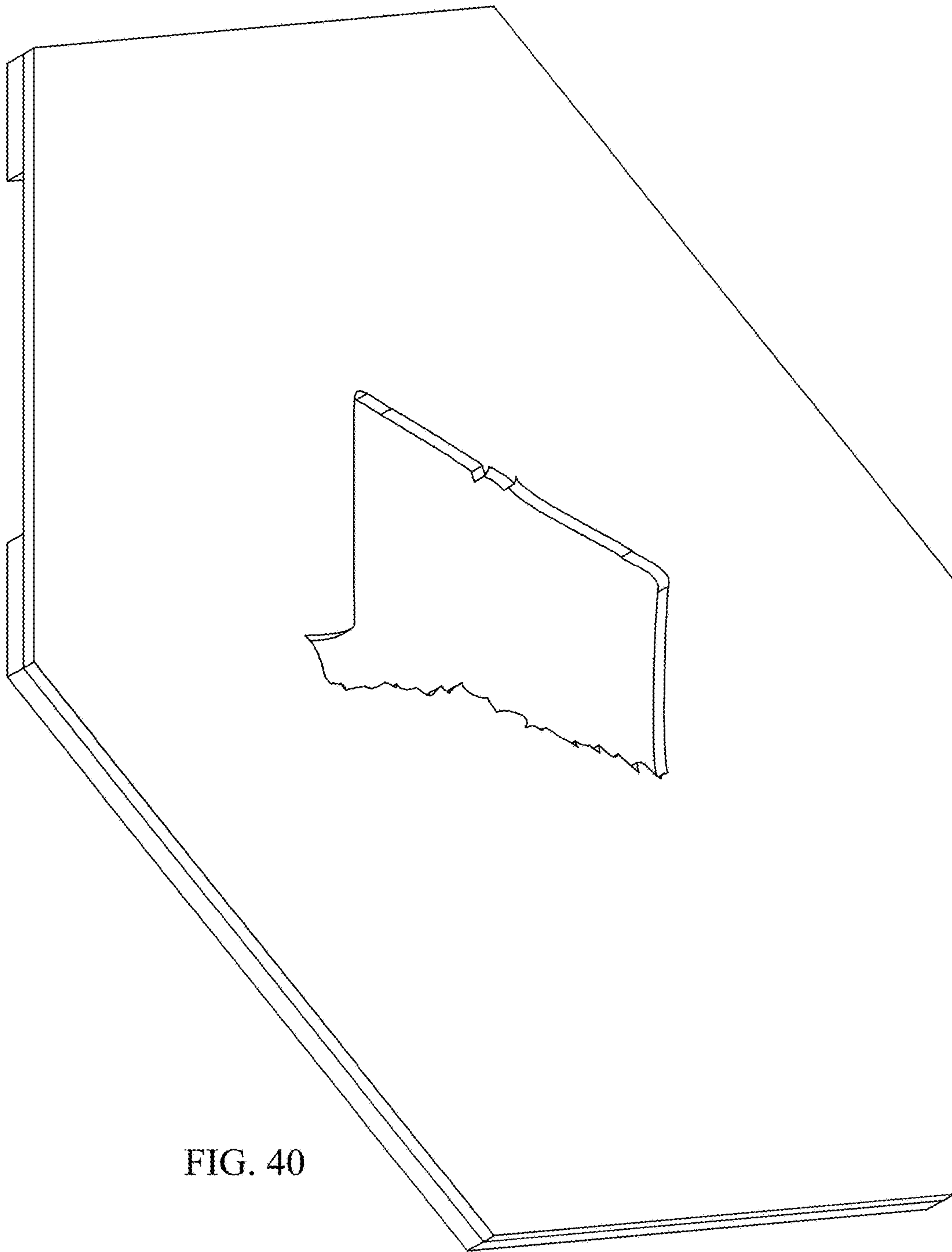

FIG. 40

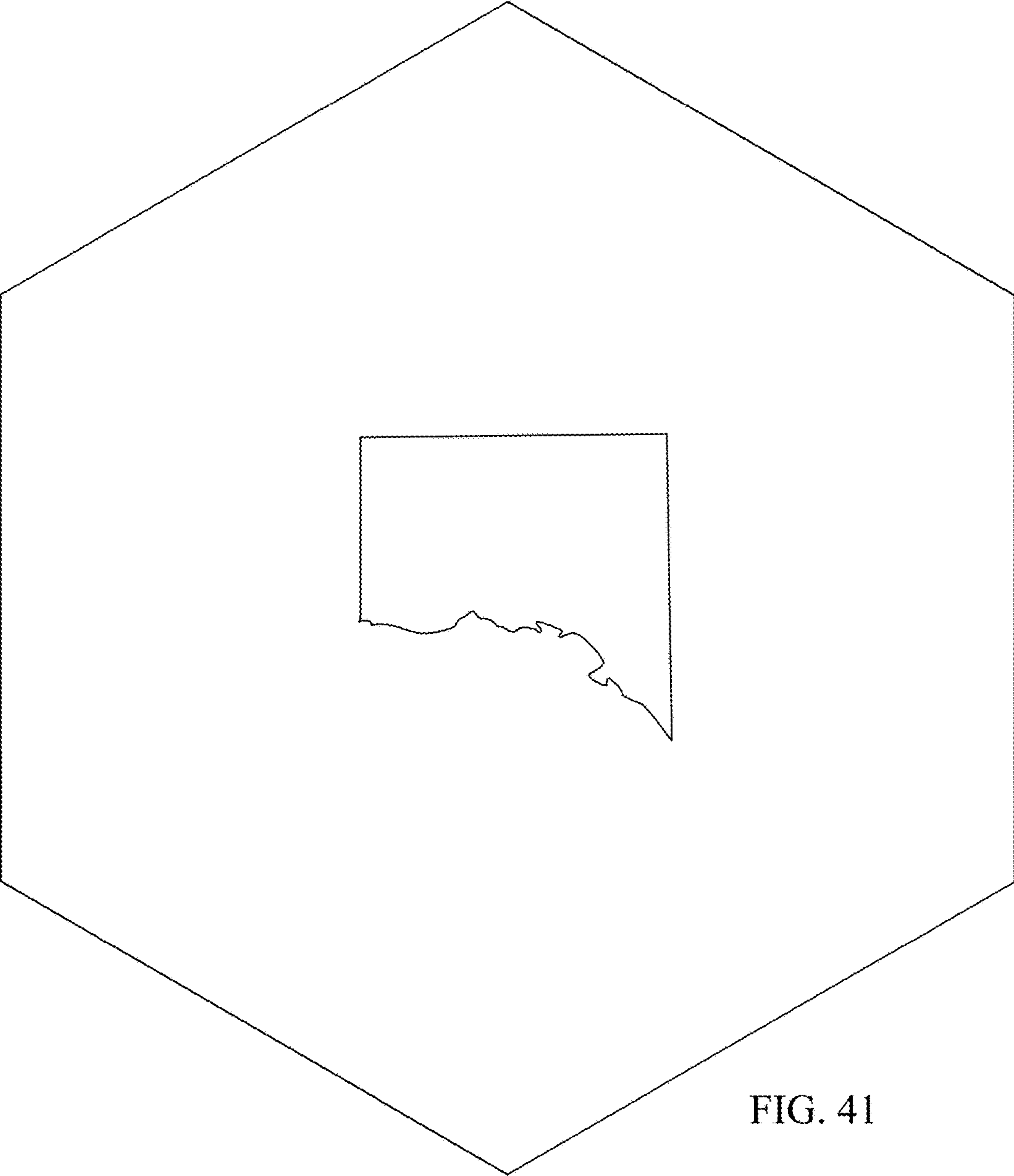

FIG. 41

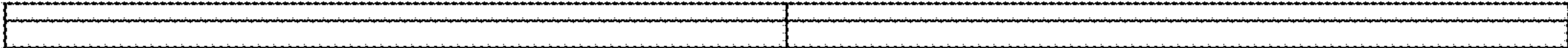

FIG. 42

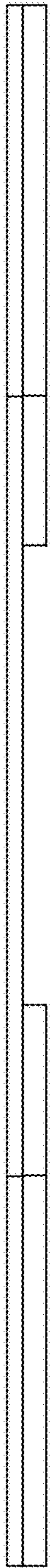

FIG. 43

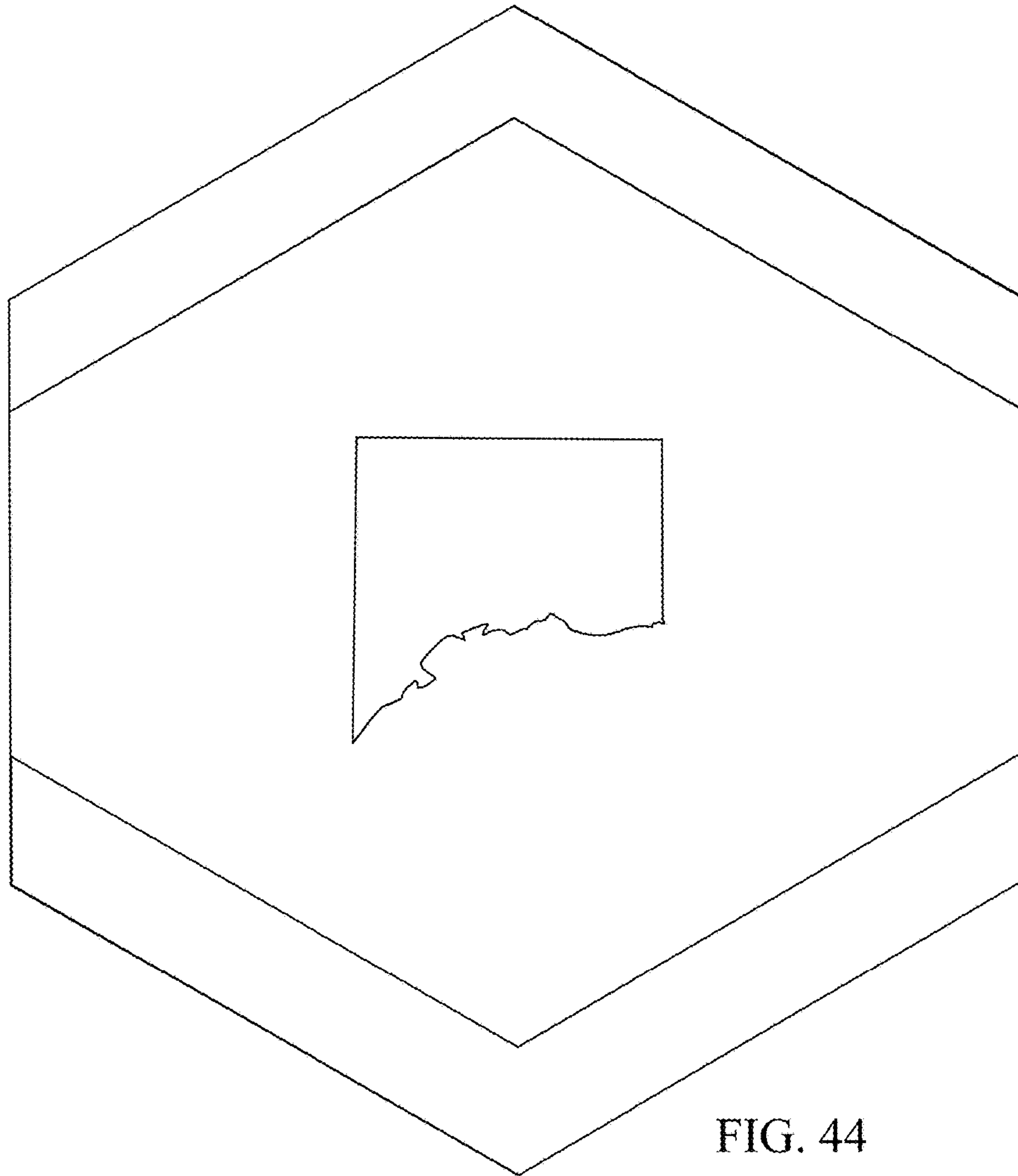

FIG. 44

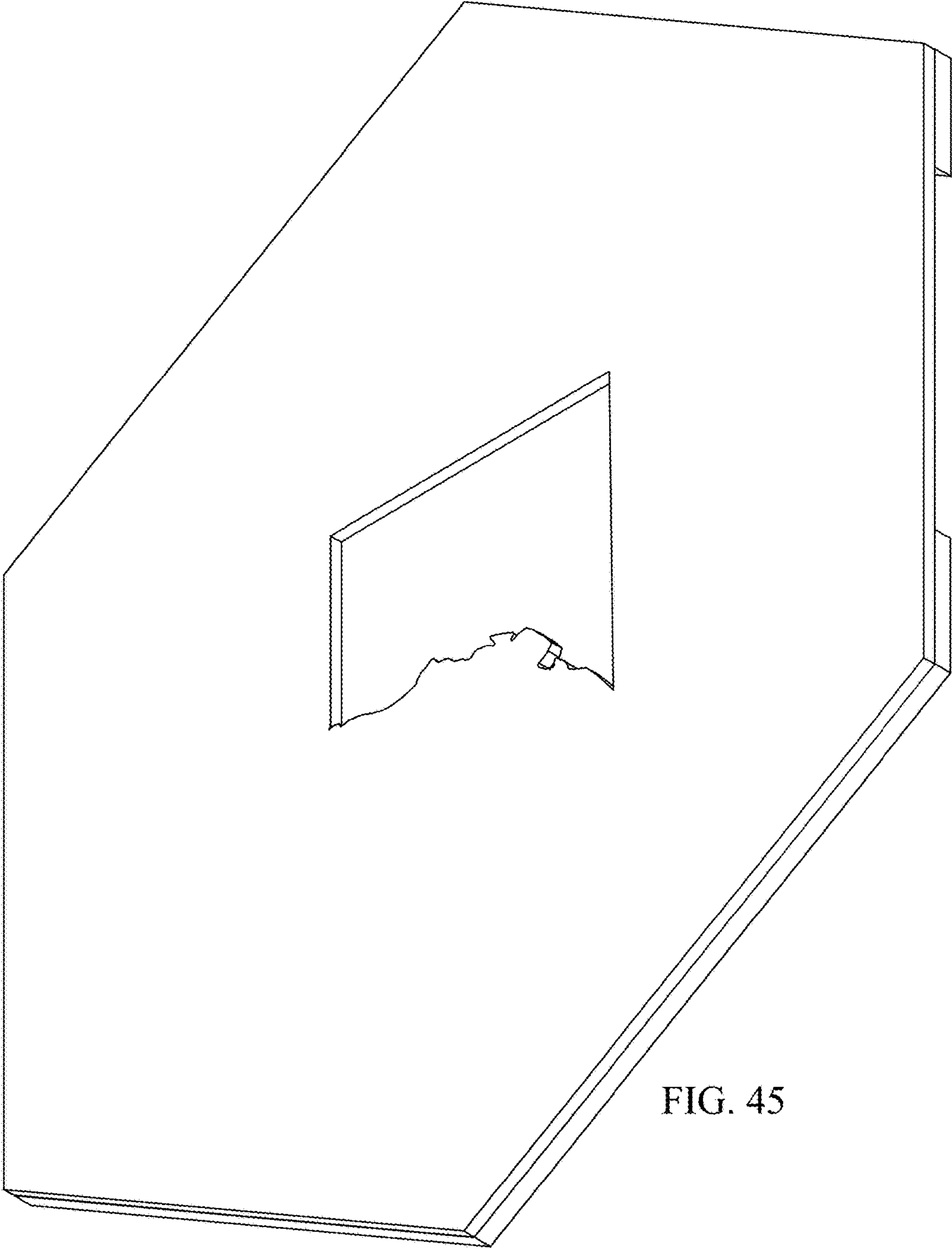

FIG. 45

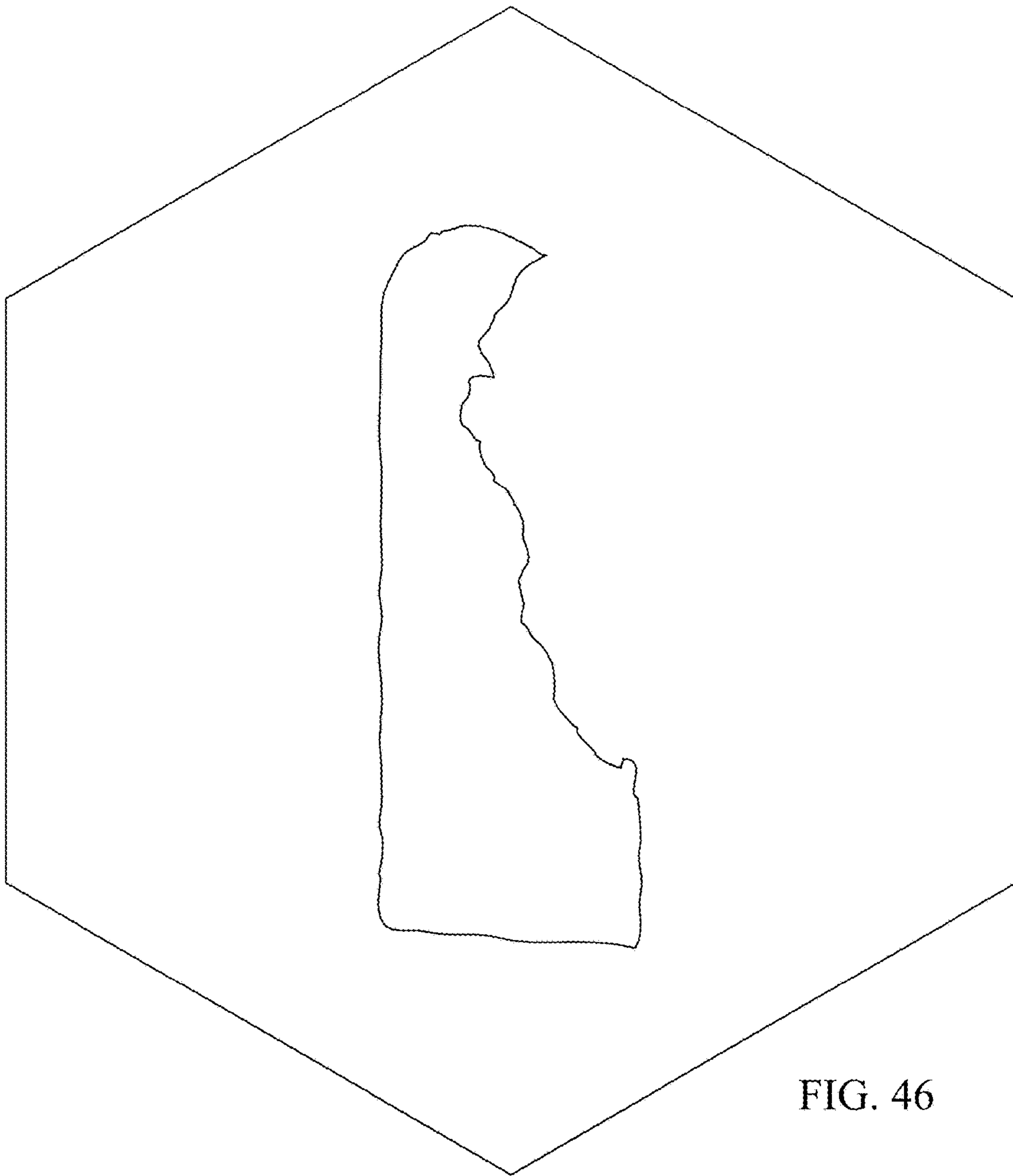

FIG. 46

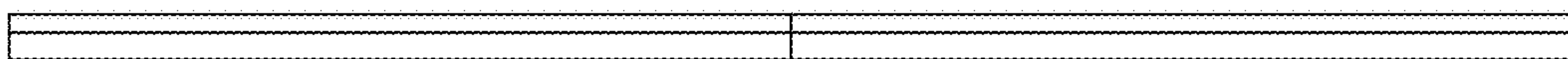

FIG. 47

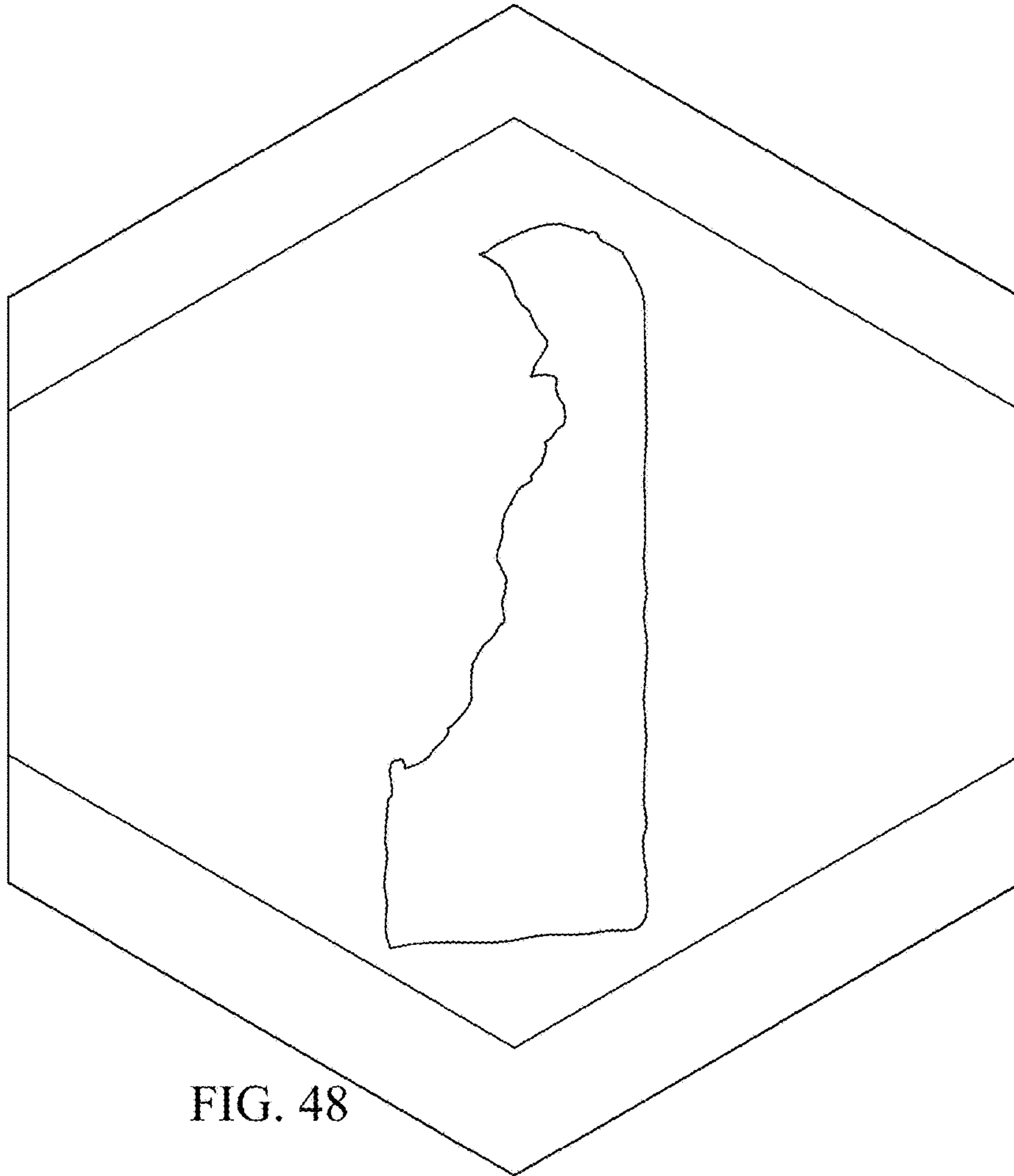

FIG. 48



FIG. 49

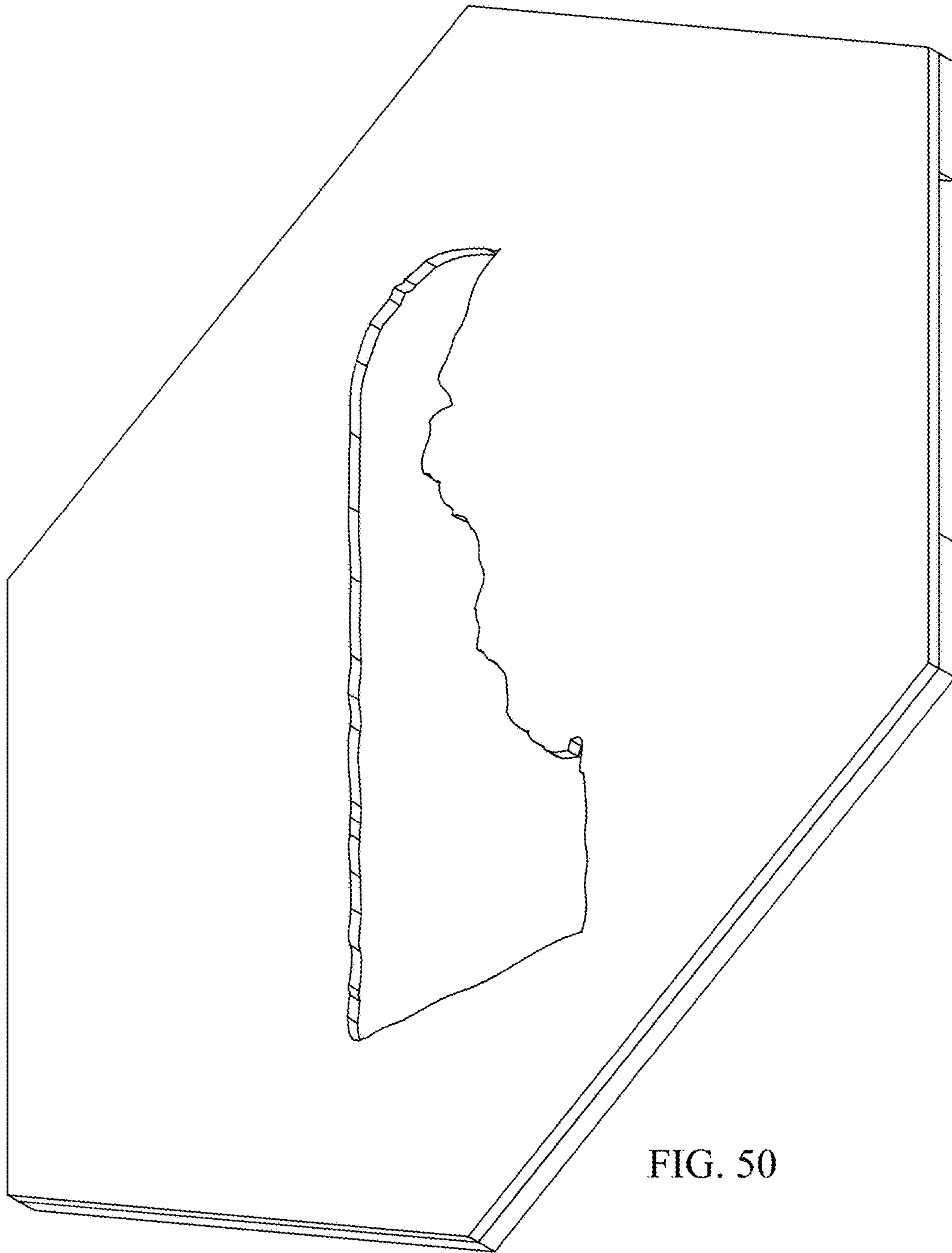

FIG. 50

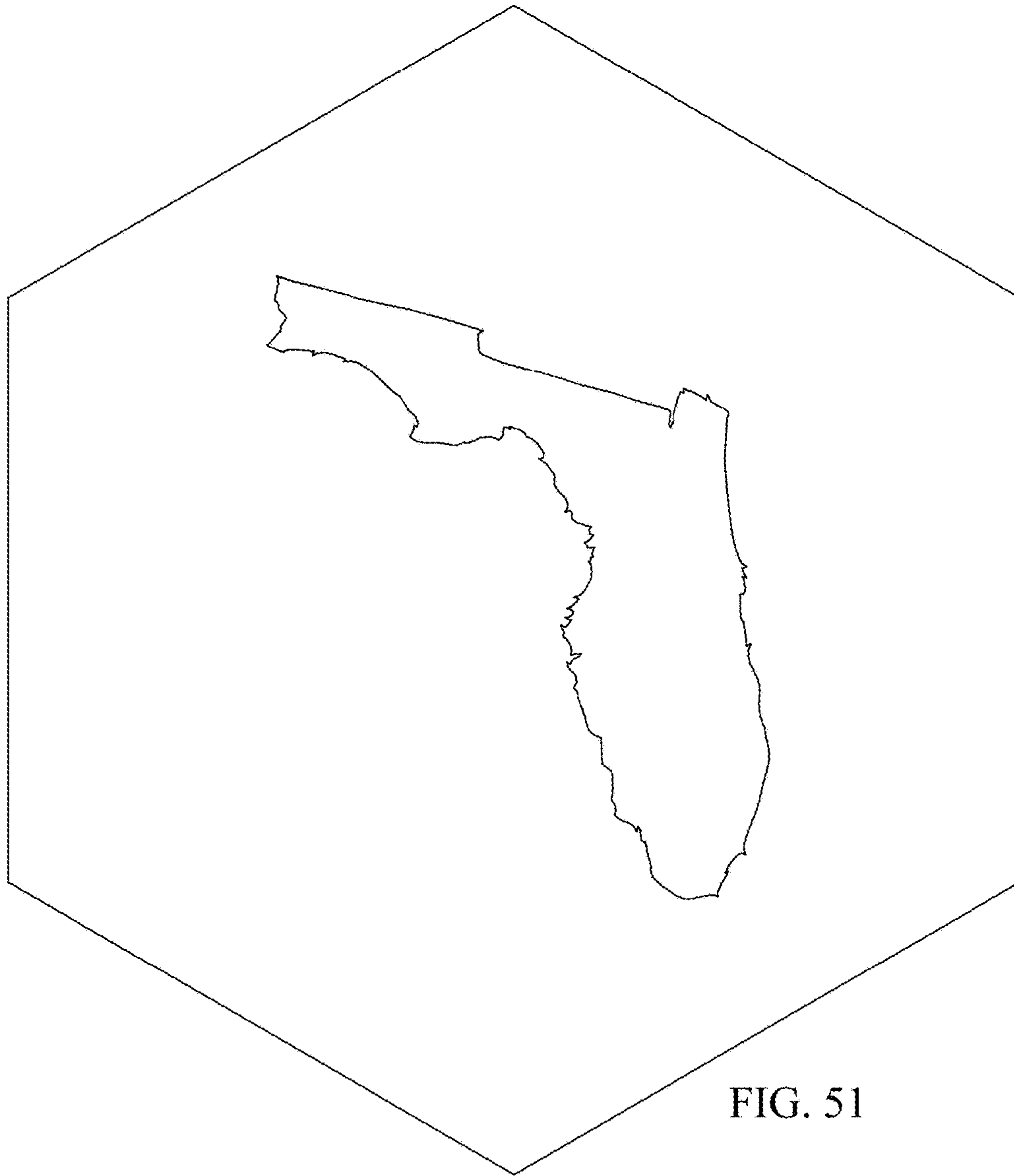

FIG. 51

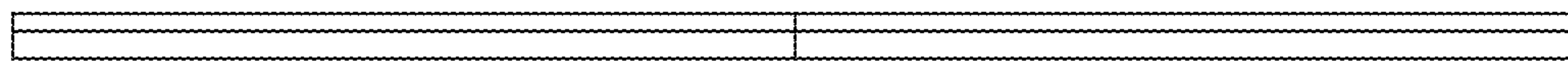

FIG. 52

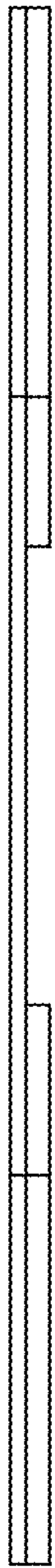

FIG. 53

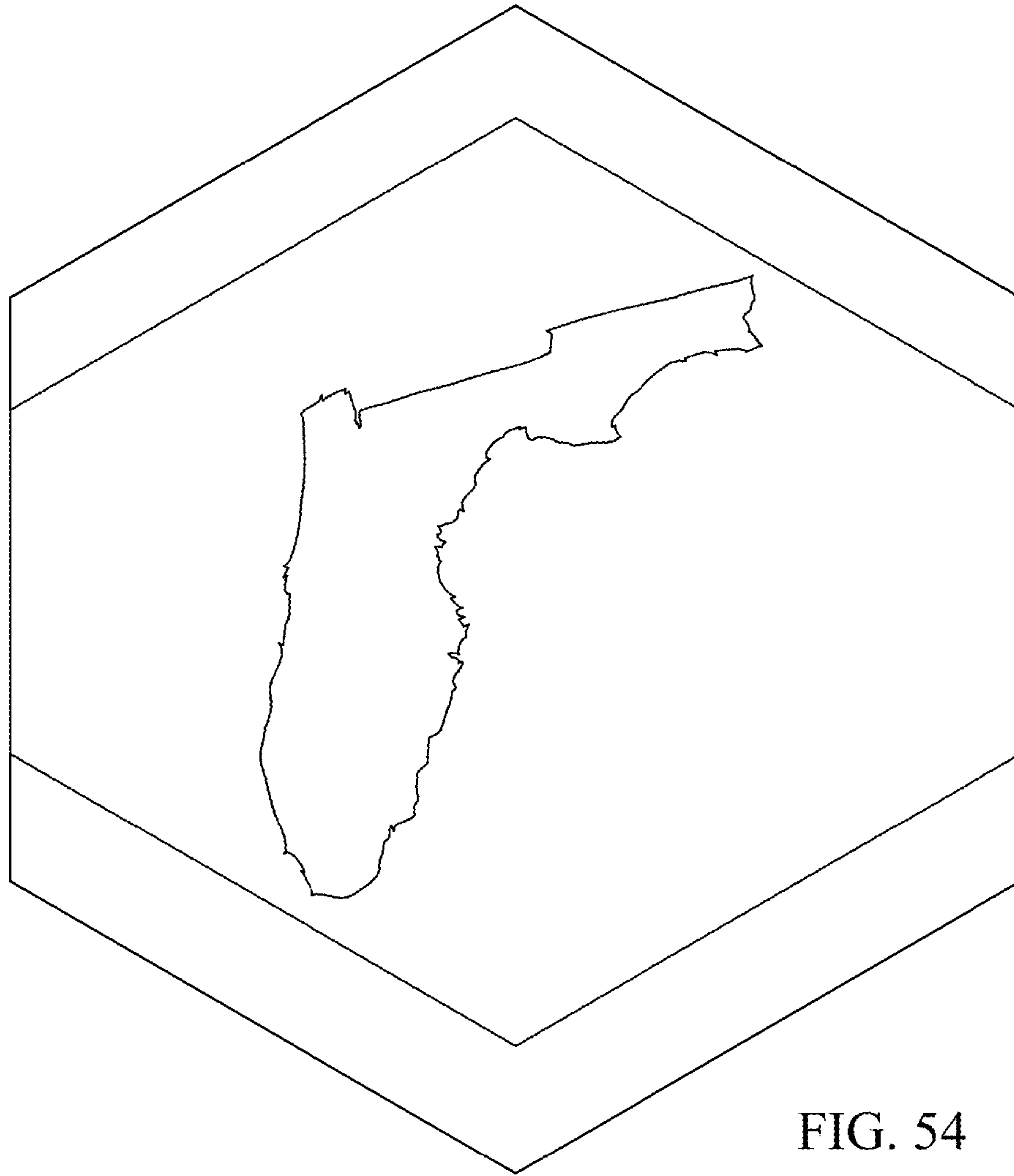

FIG. 54

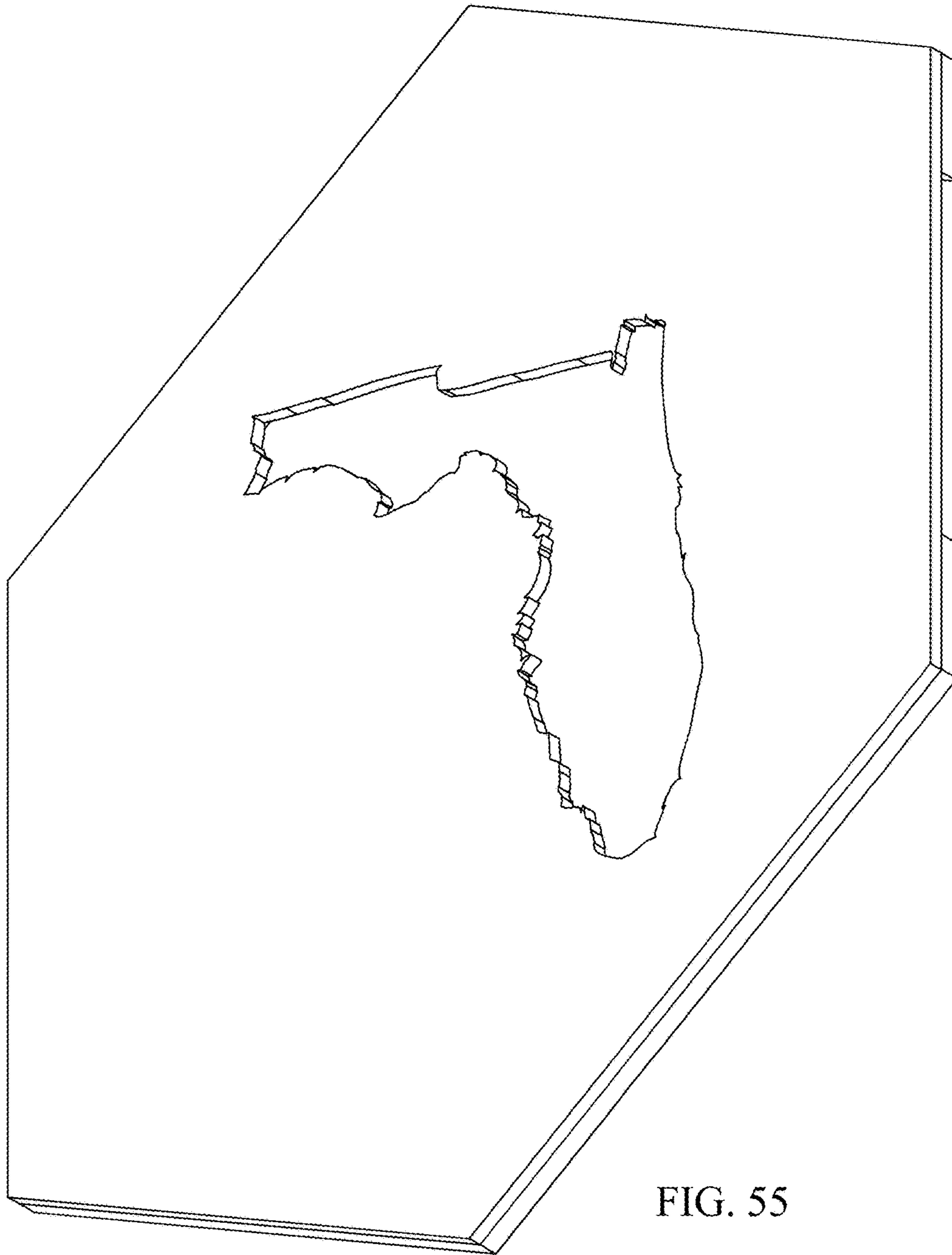

FIG. 55

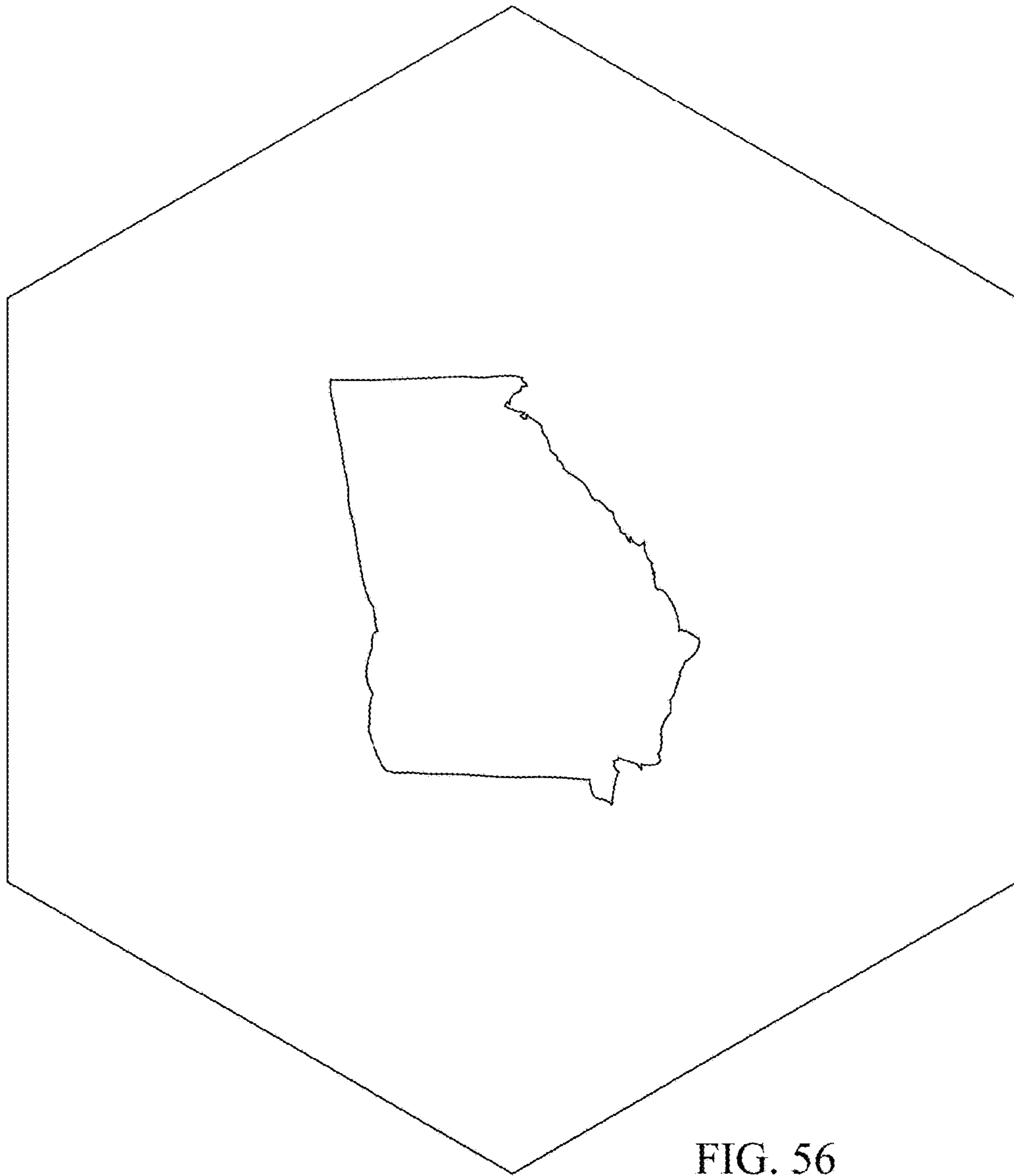

FIG. 56



FIG. 57

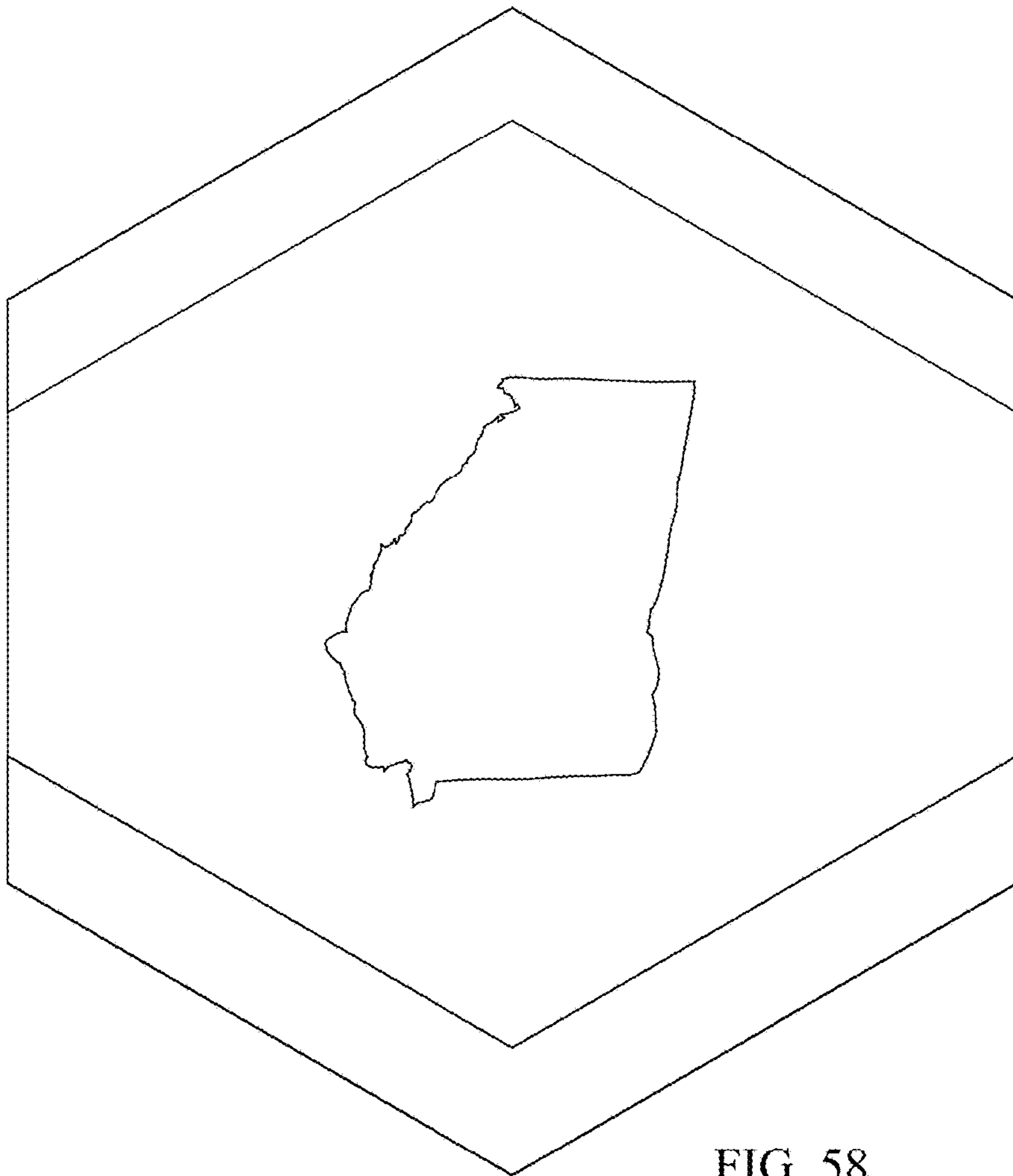

FIG. 58

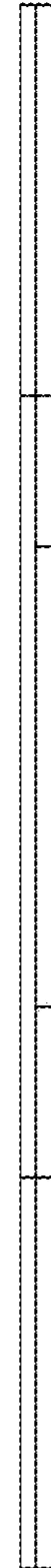

FIG. 59

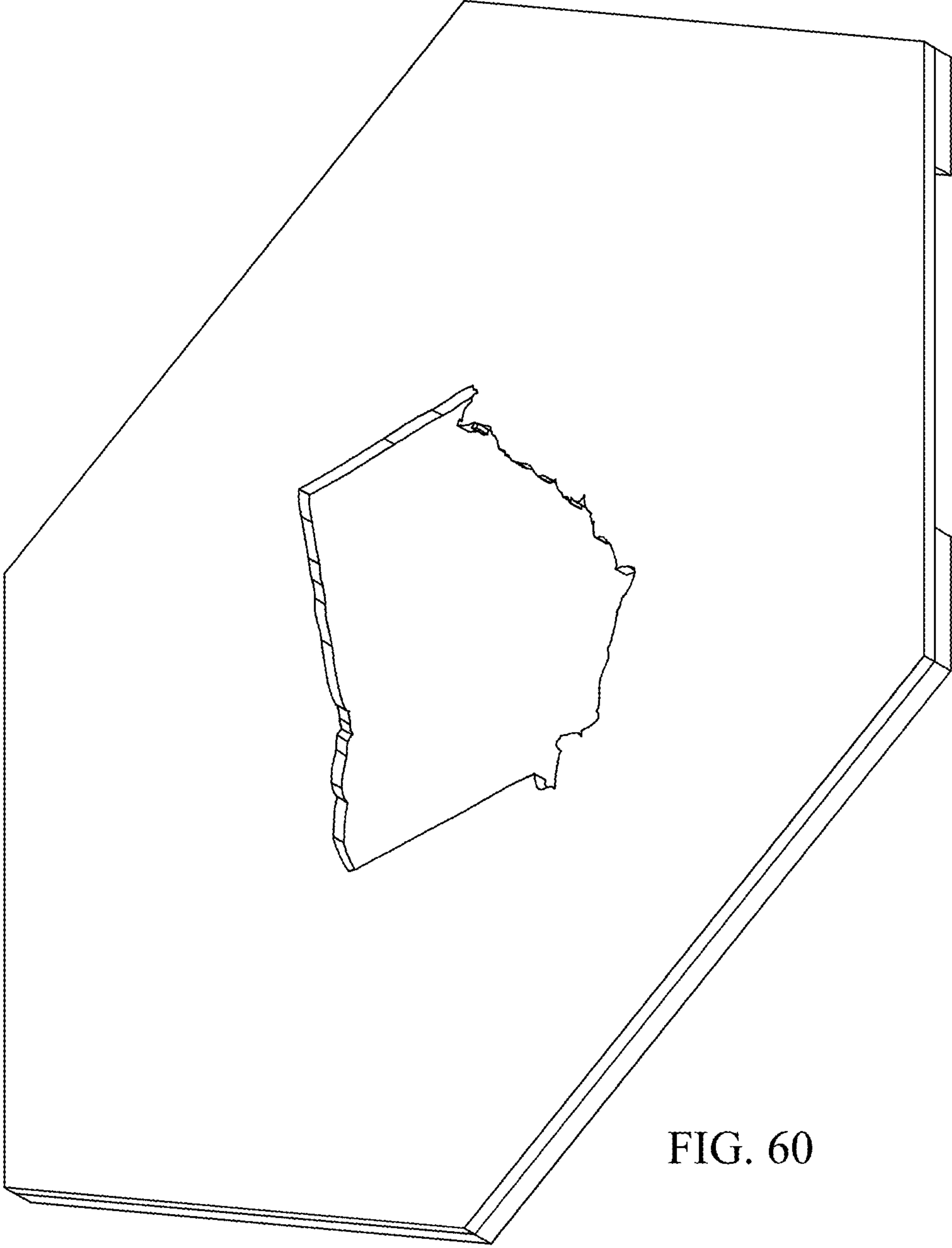

FIG. 60

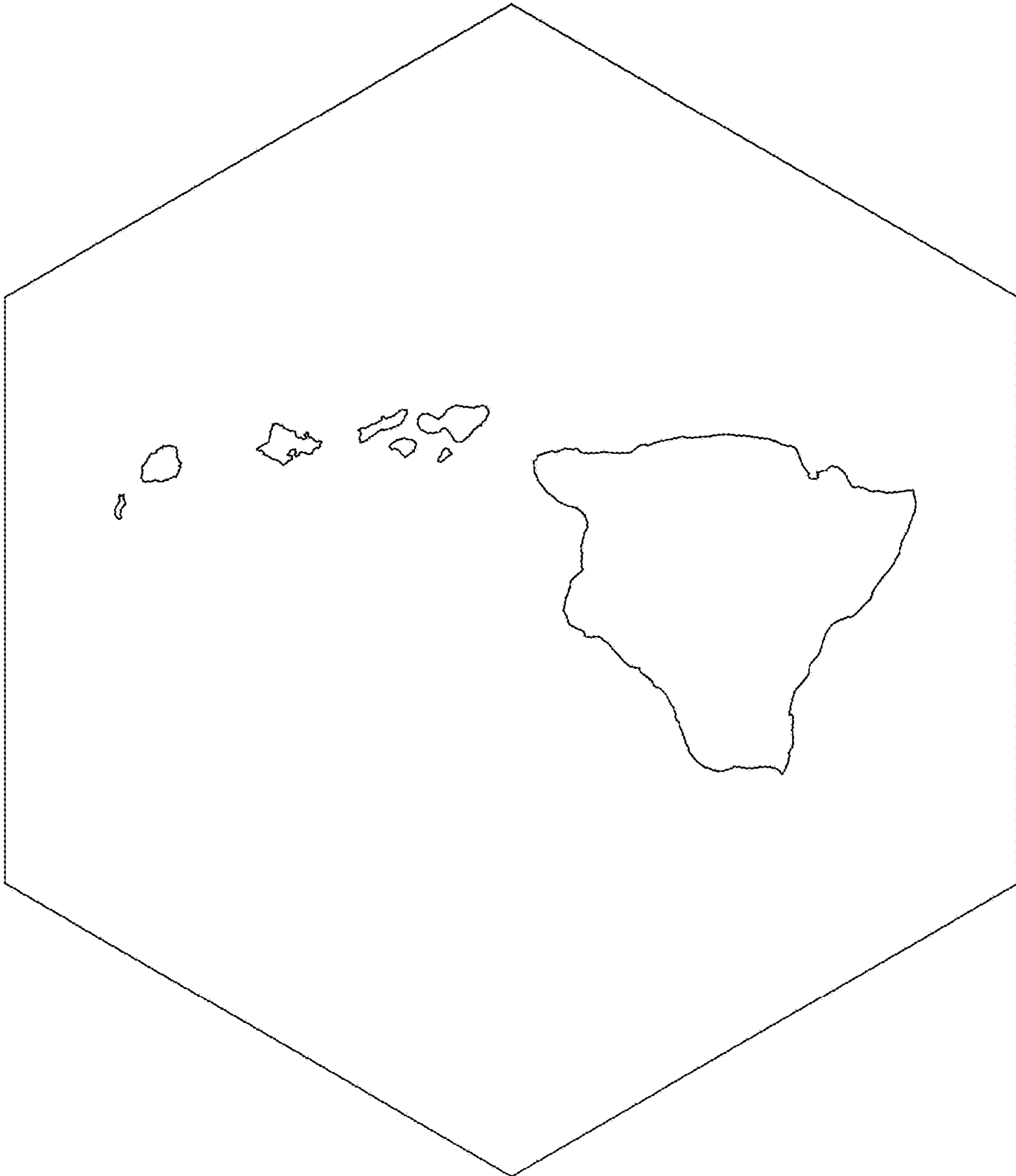

FIG. 61

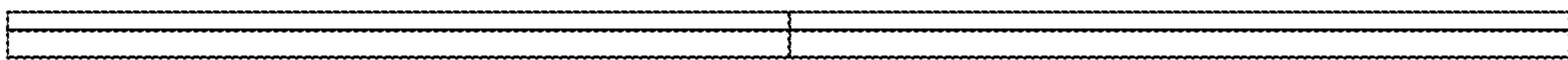

FIG. 62

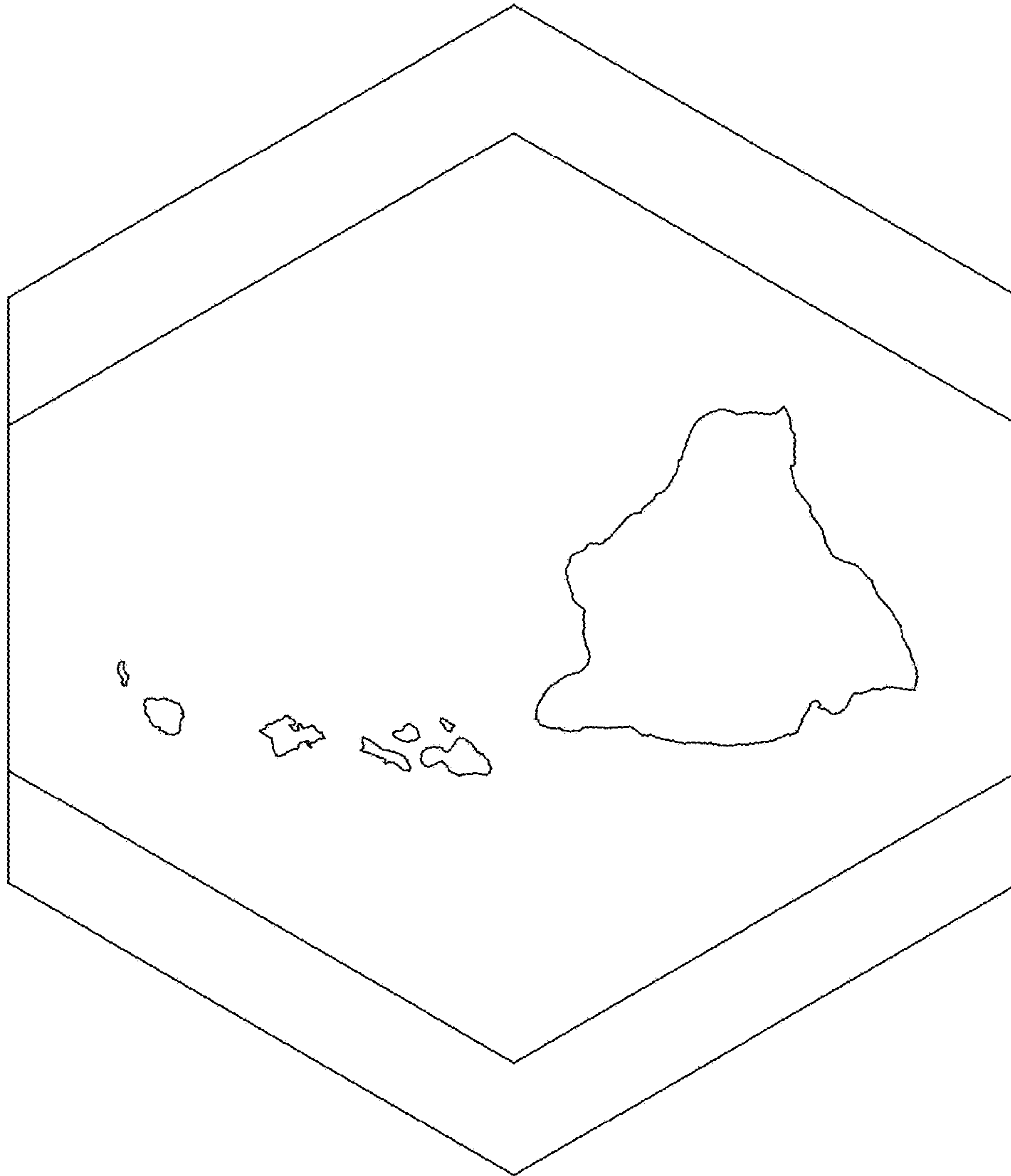

FIG. 63

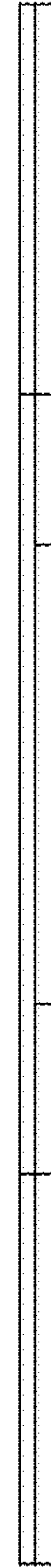

FIG. 64

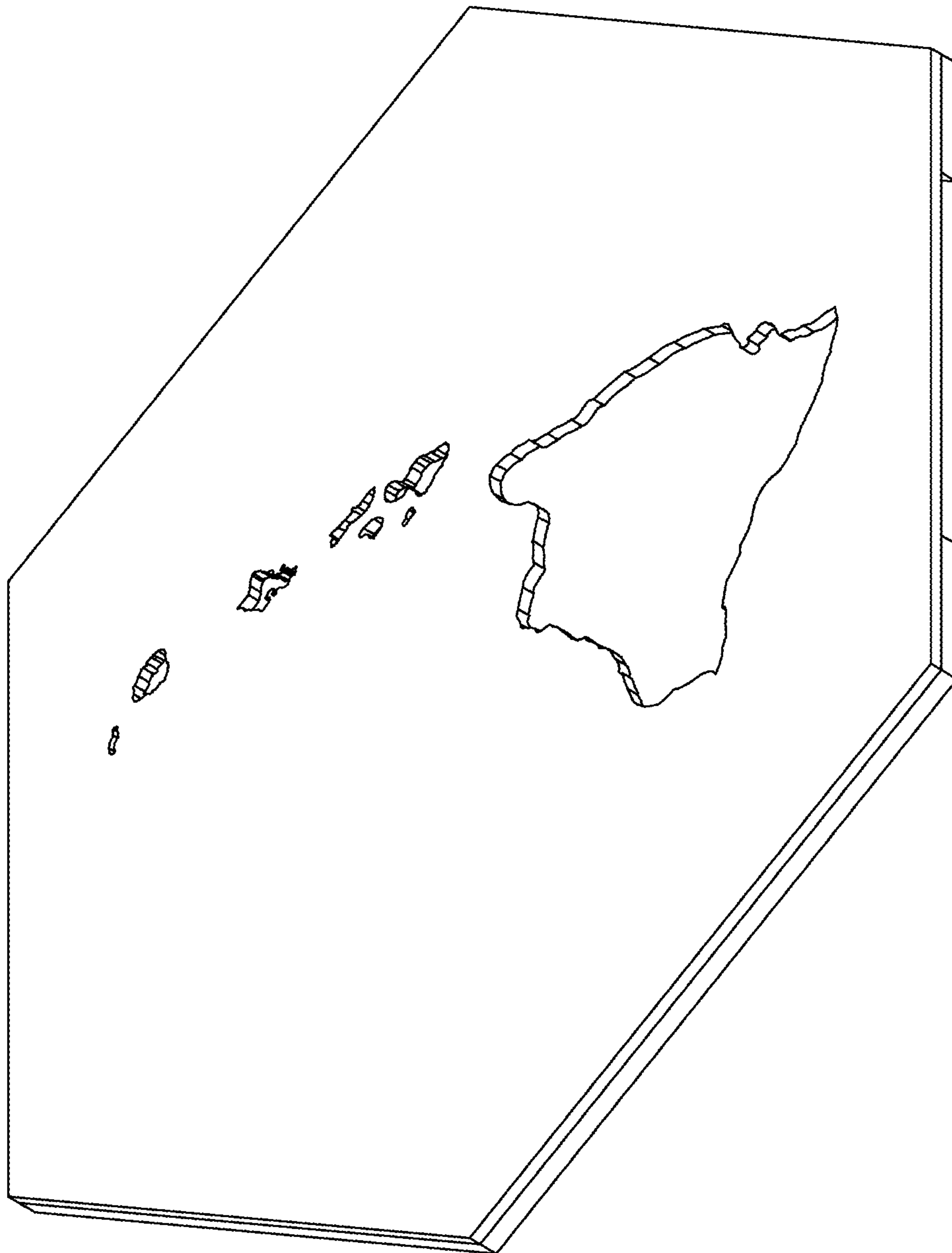

FIG. 65

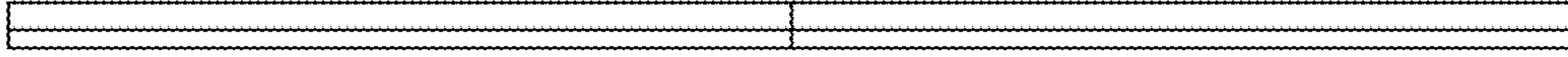

FIG. 66

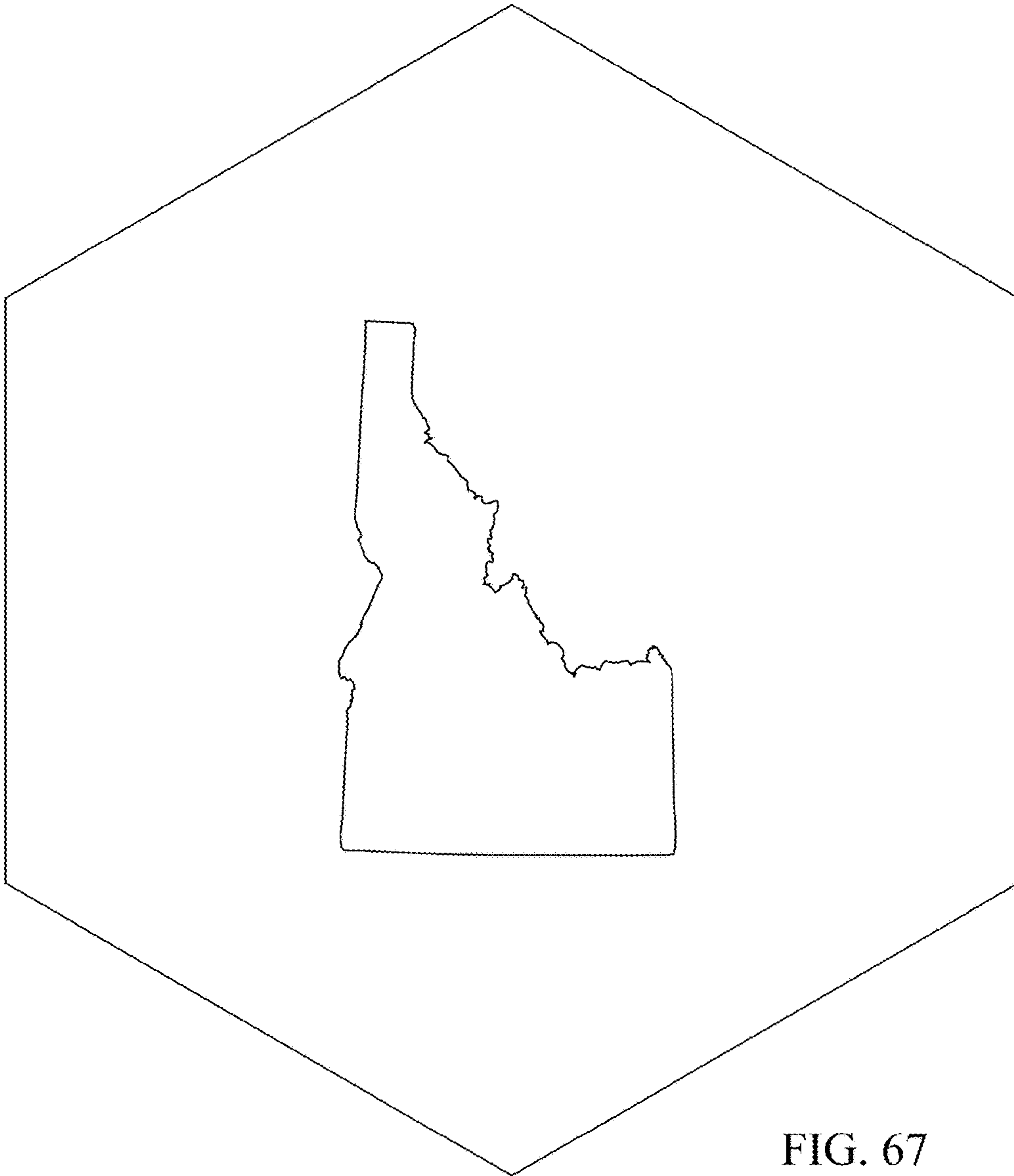

FIG. 67

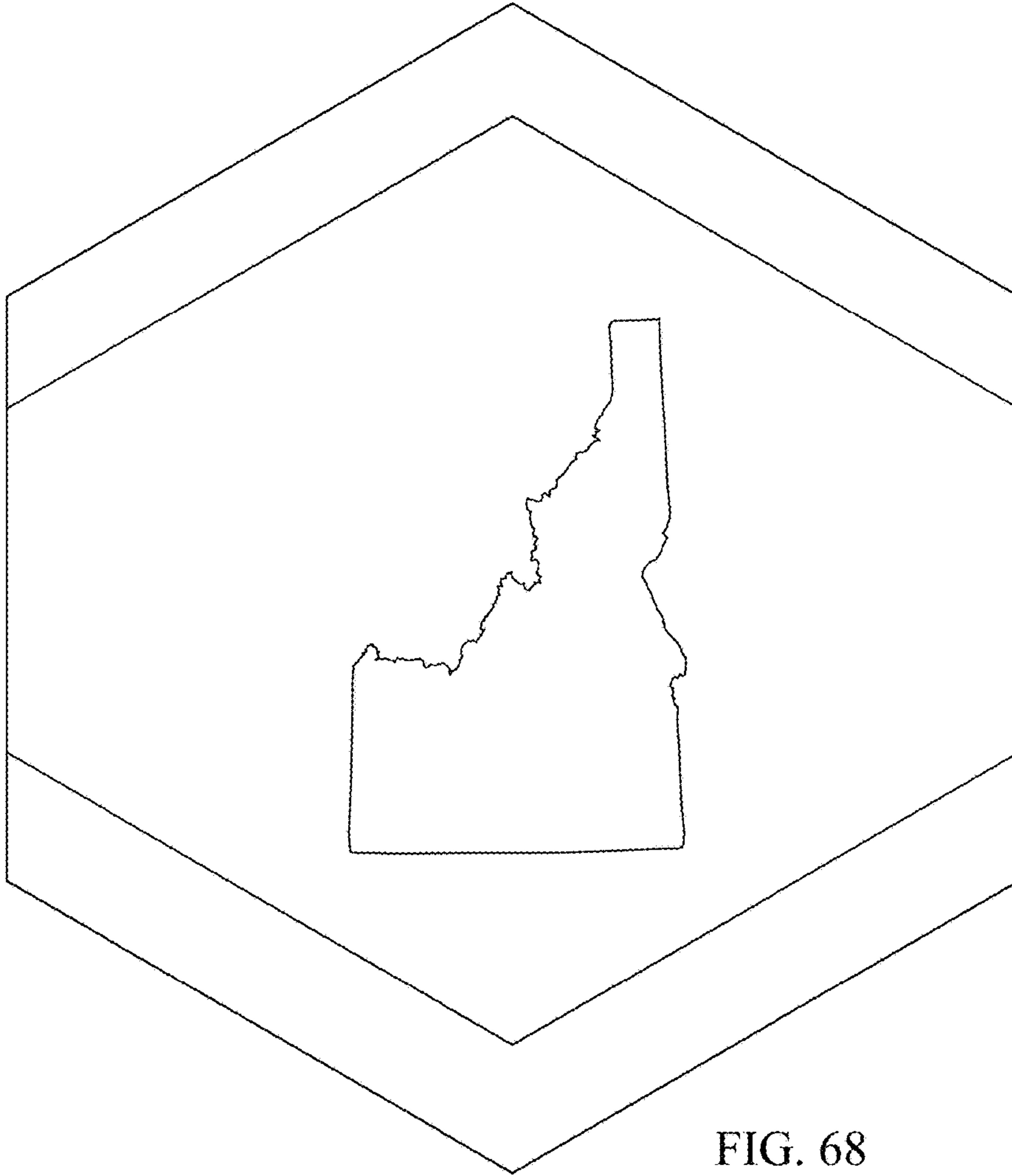

FIG. 68



FIG. 69

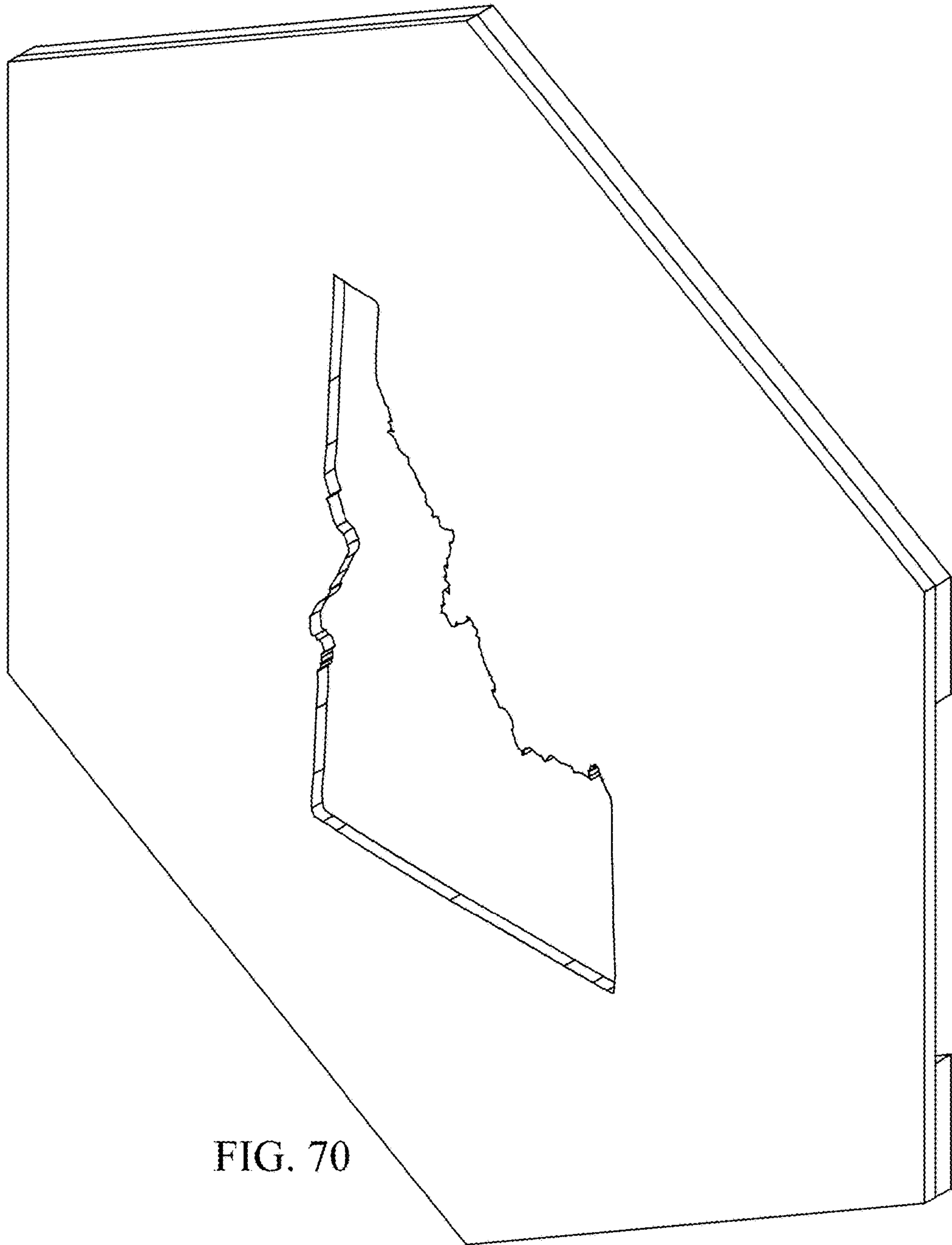

FIG. 70

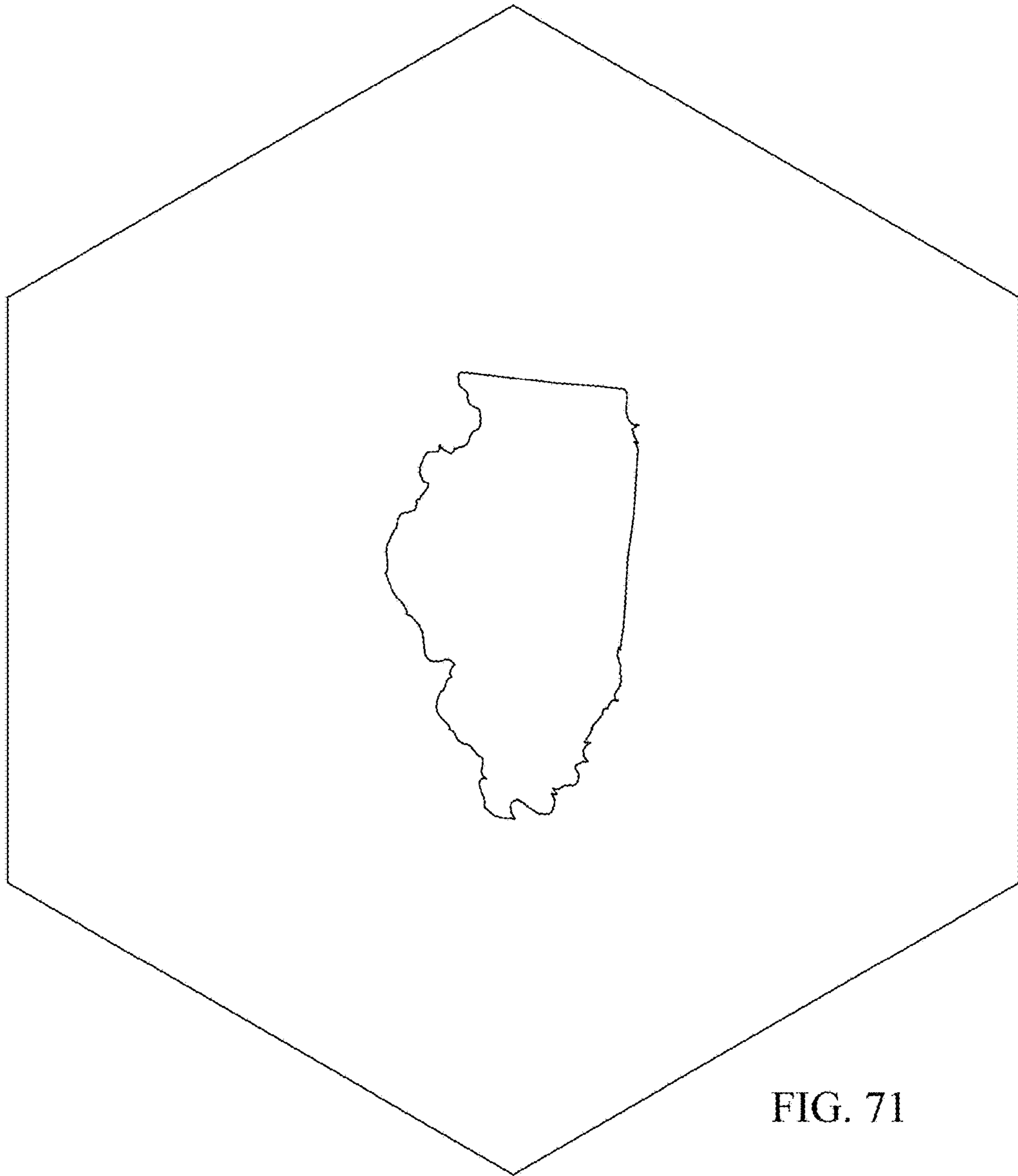

FIG. 71

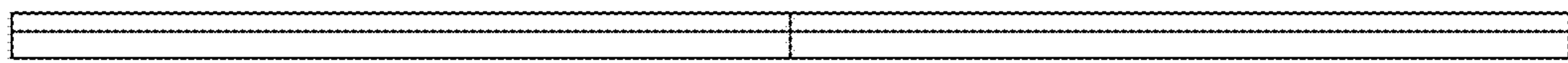

FIG. 72

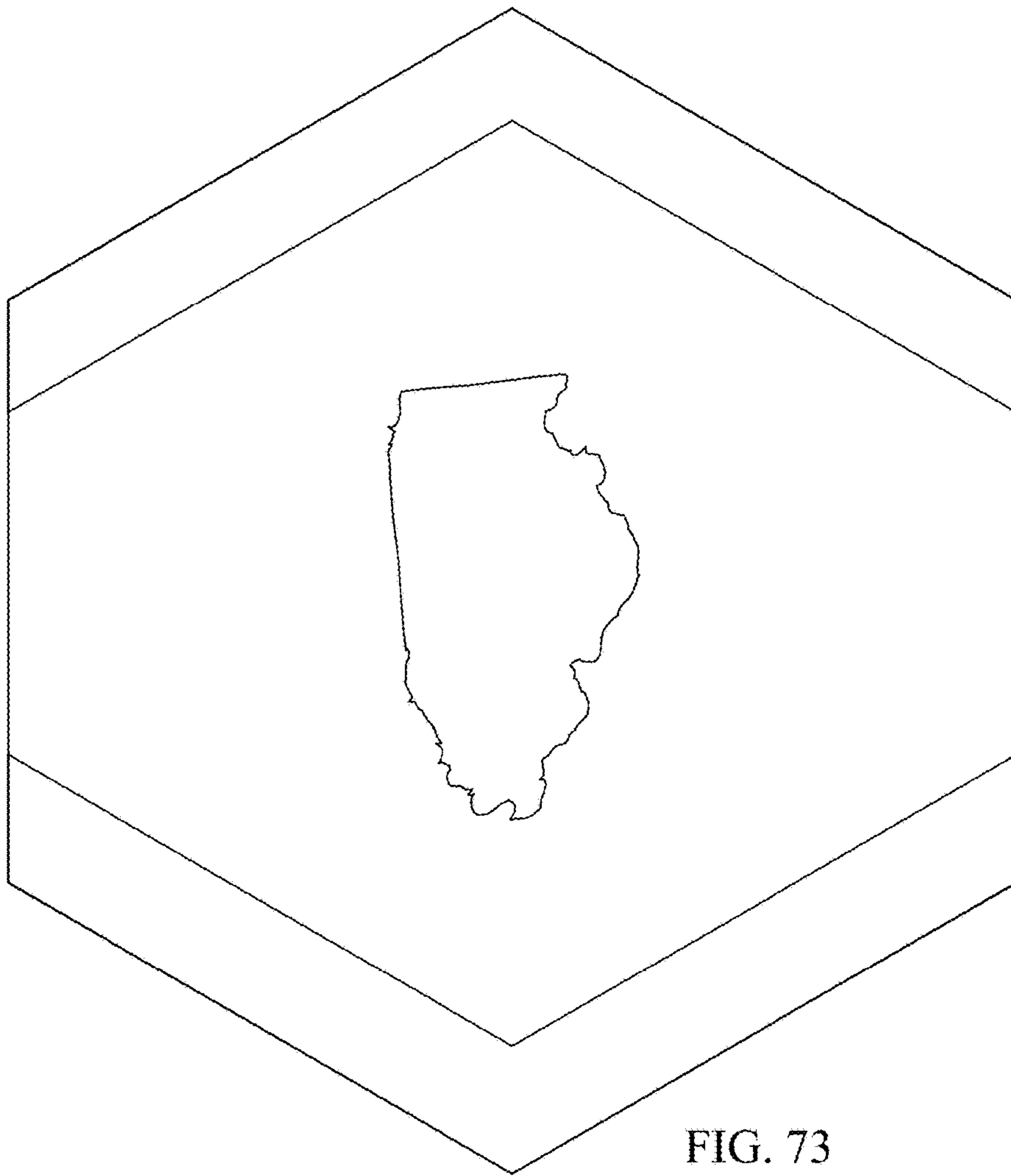

FIG. 73

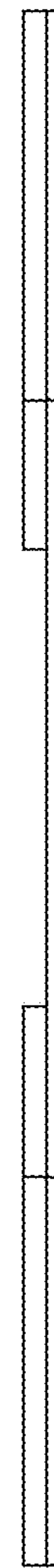

FIG. 74

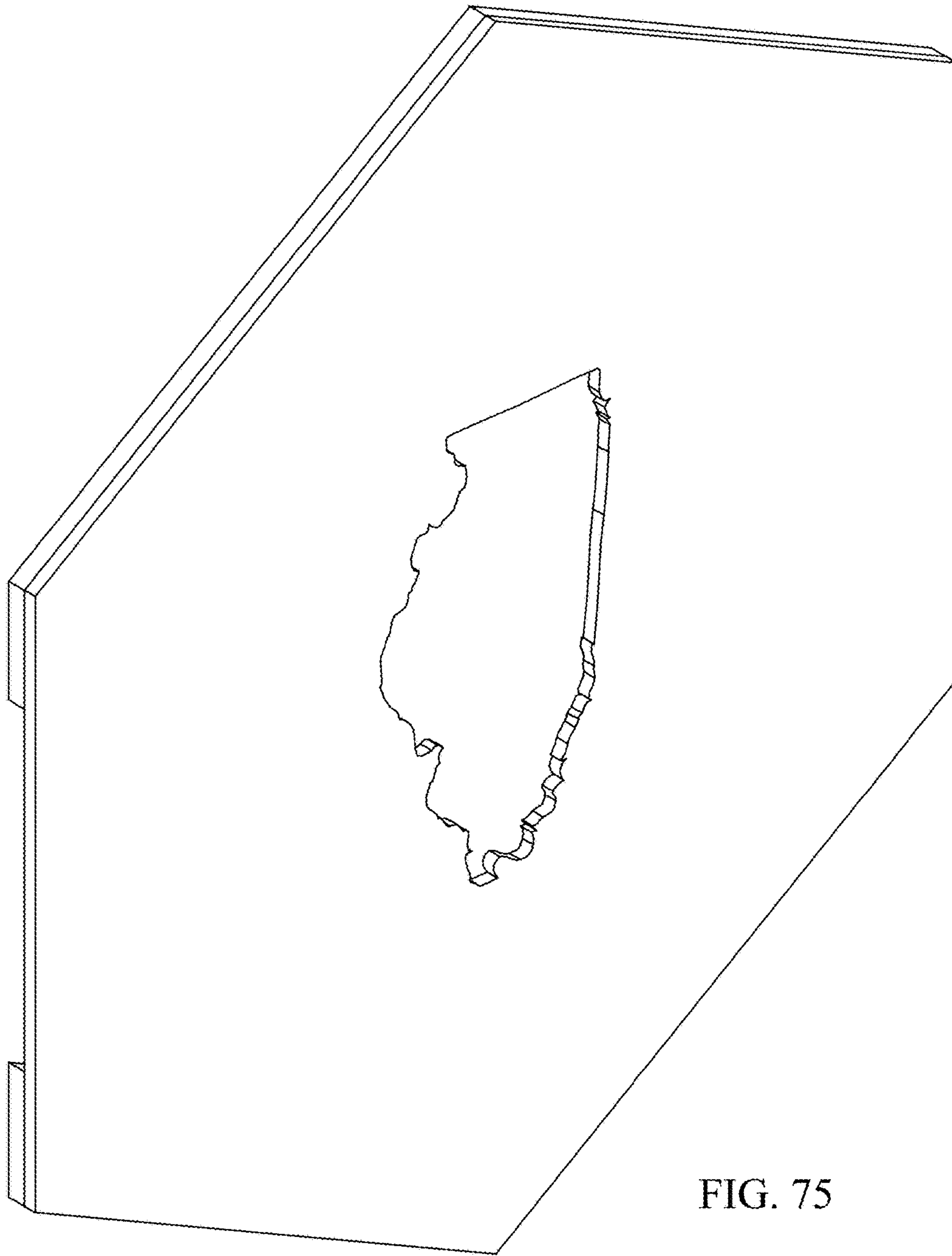

FIG. 75

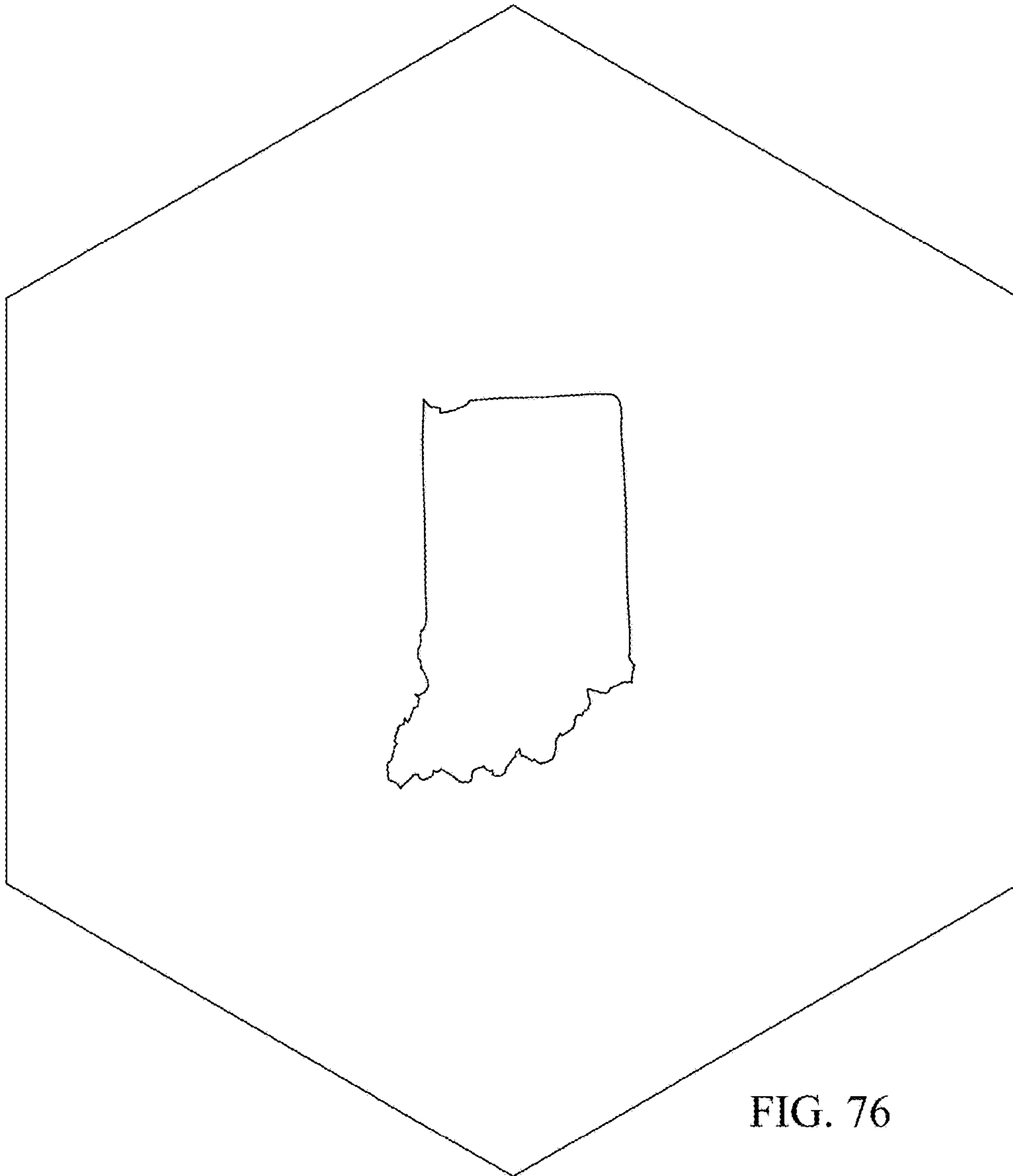

FIG. 76



FIG. 77

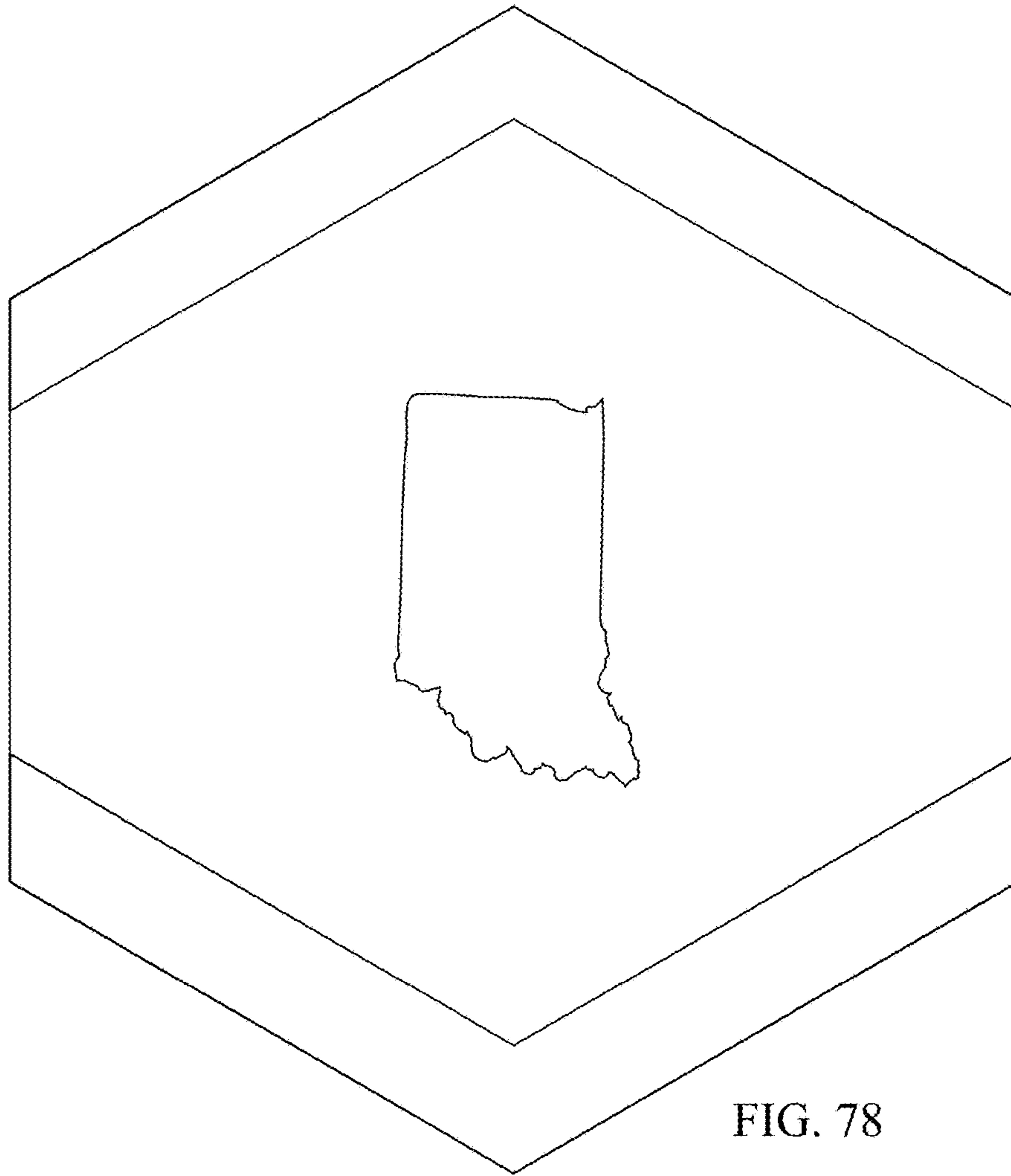

FIG. 78



FIG. 79

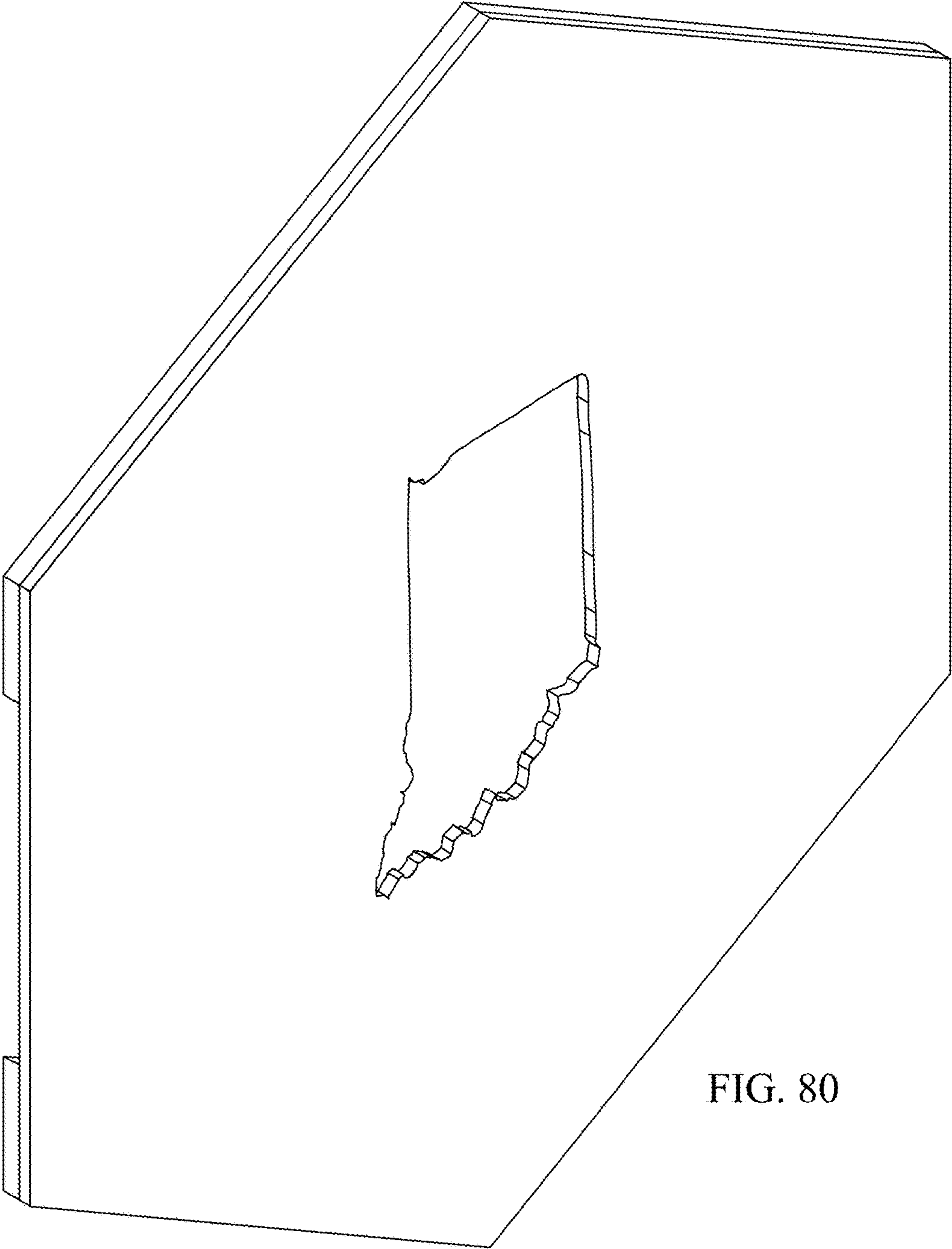

FIG. 80

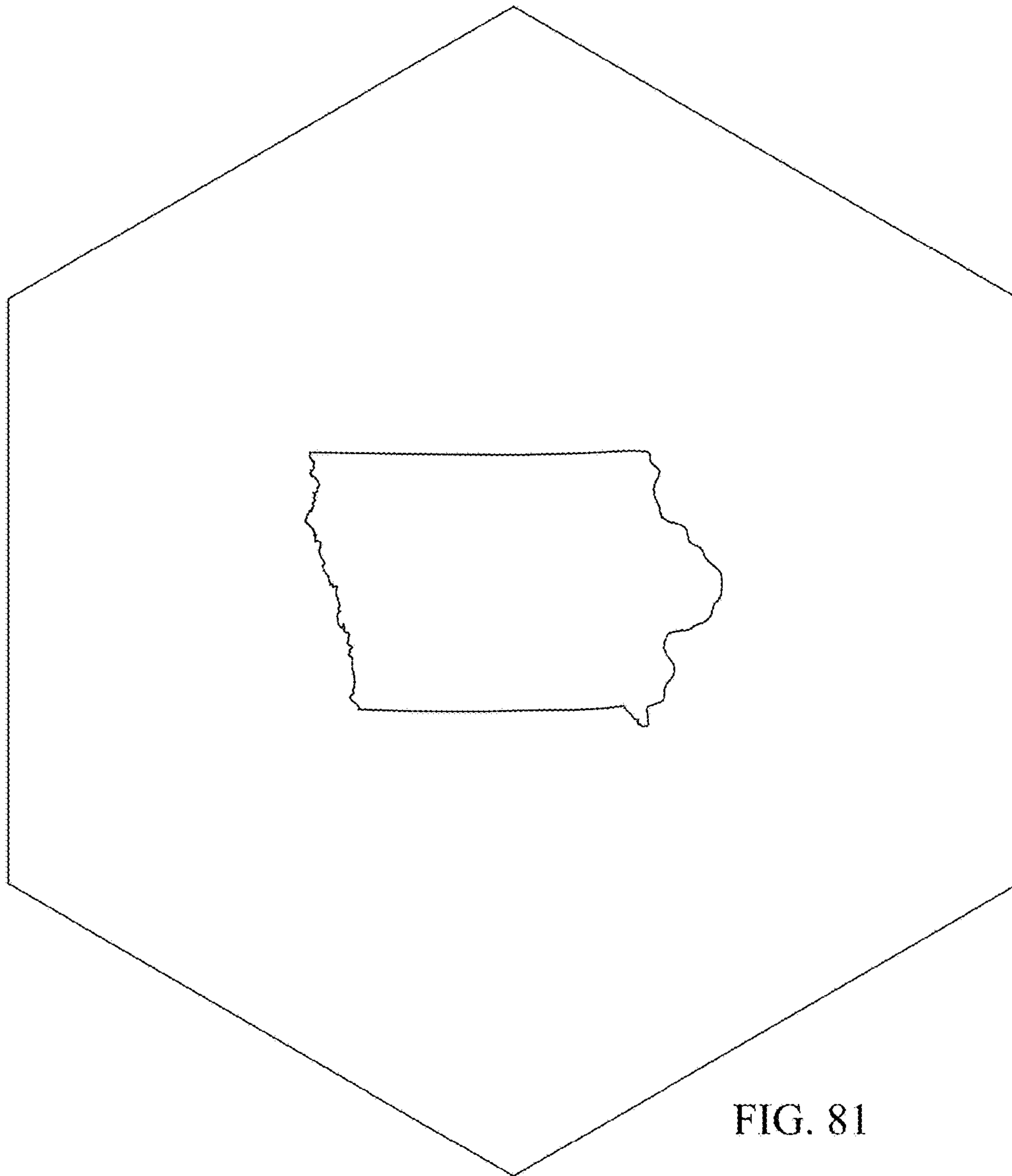

FIG. 81

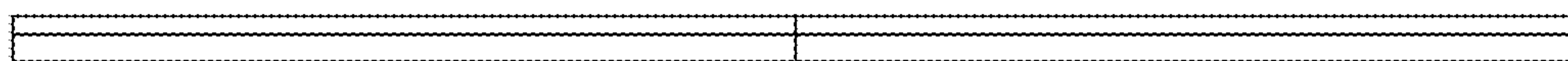

FIG. 82

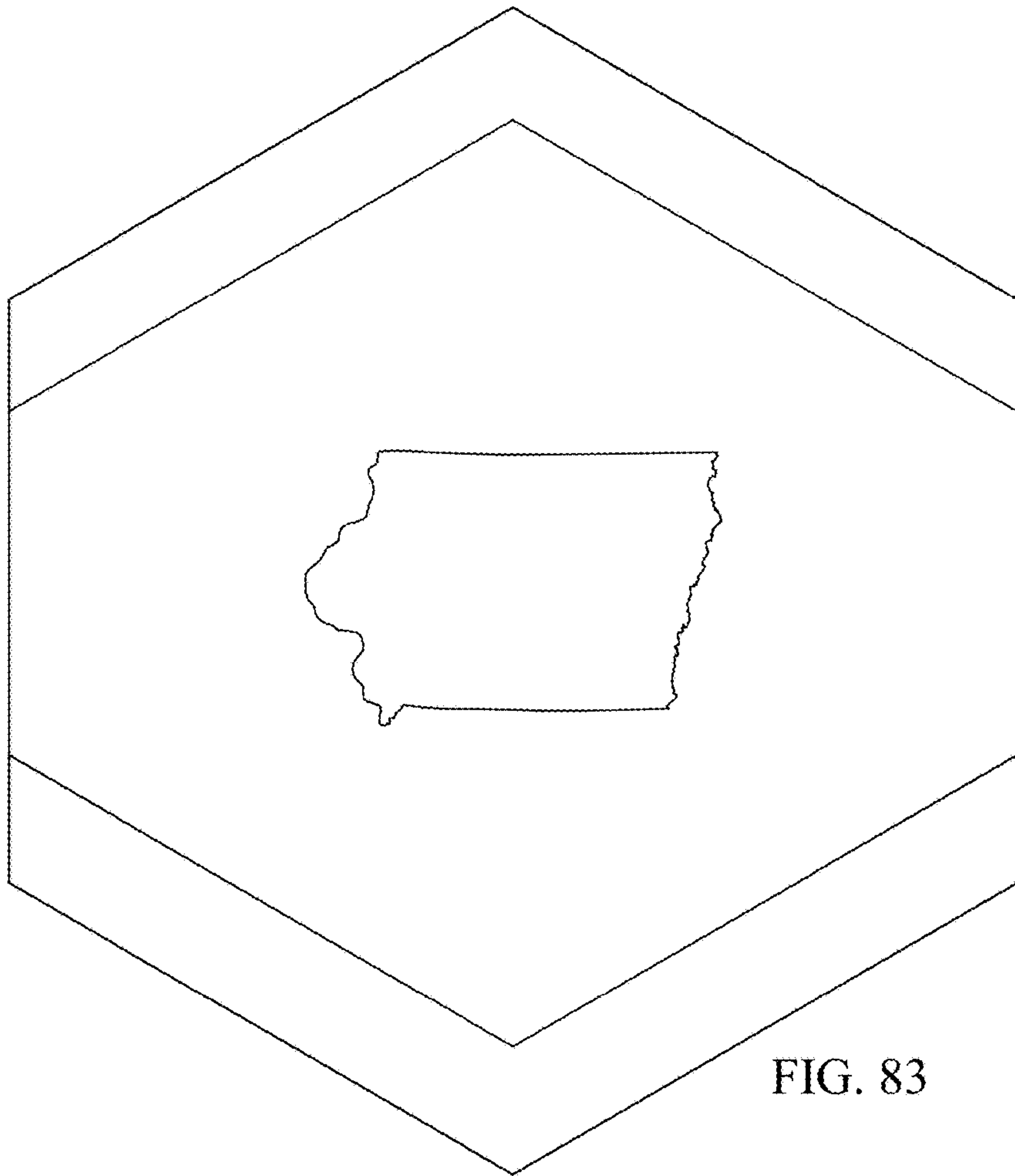

FIG. 83

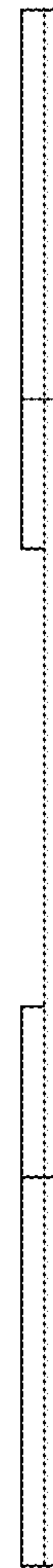

FIG. 84

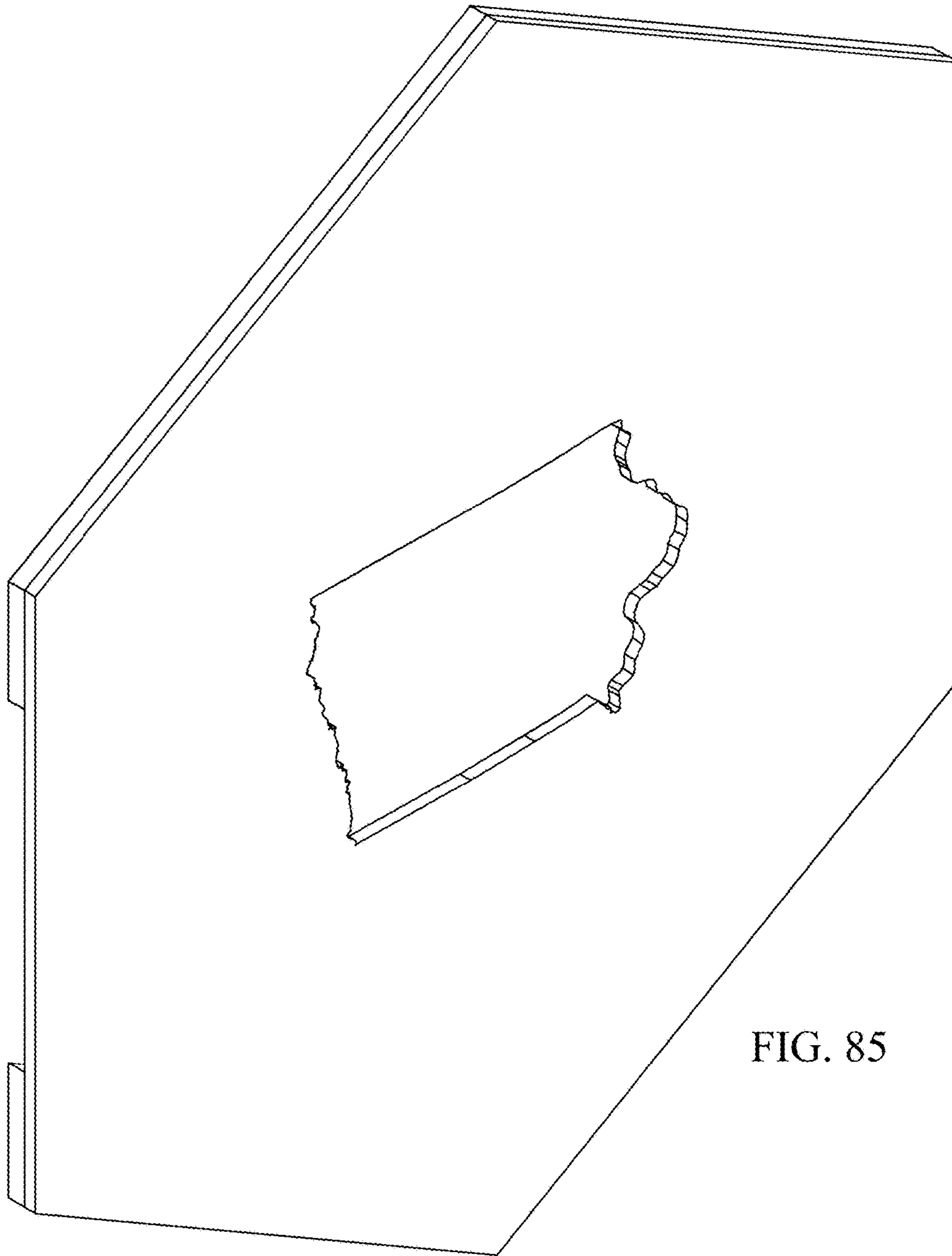

FIG. 85

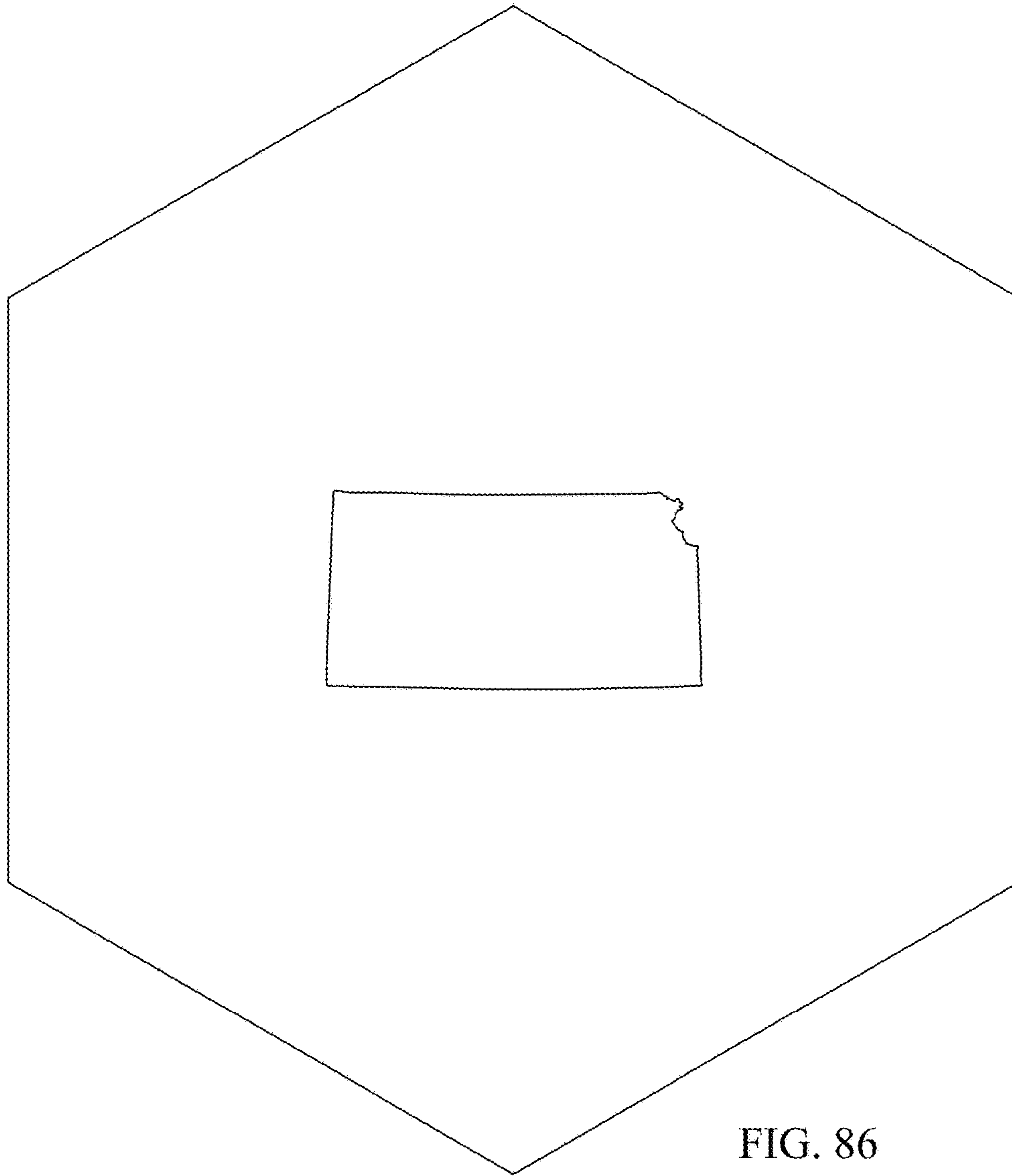

FIG. 86

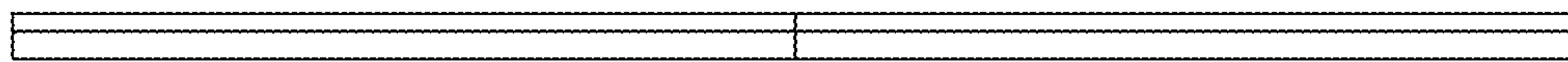

FIG. 87

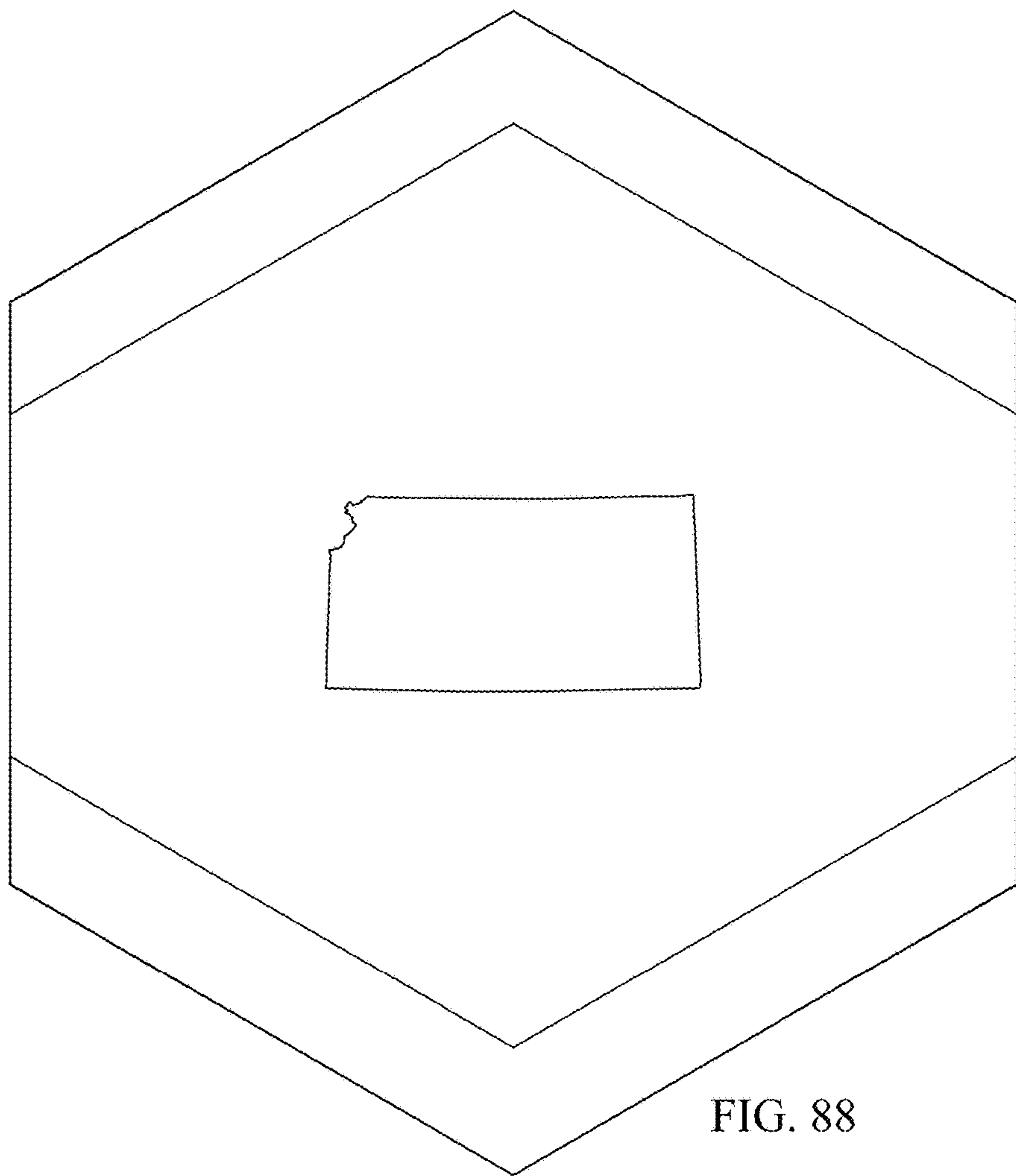

FIG. 88



FIG. 89

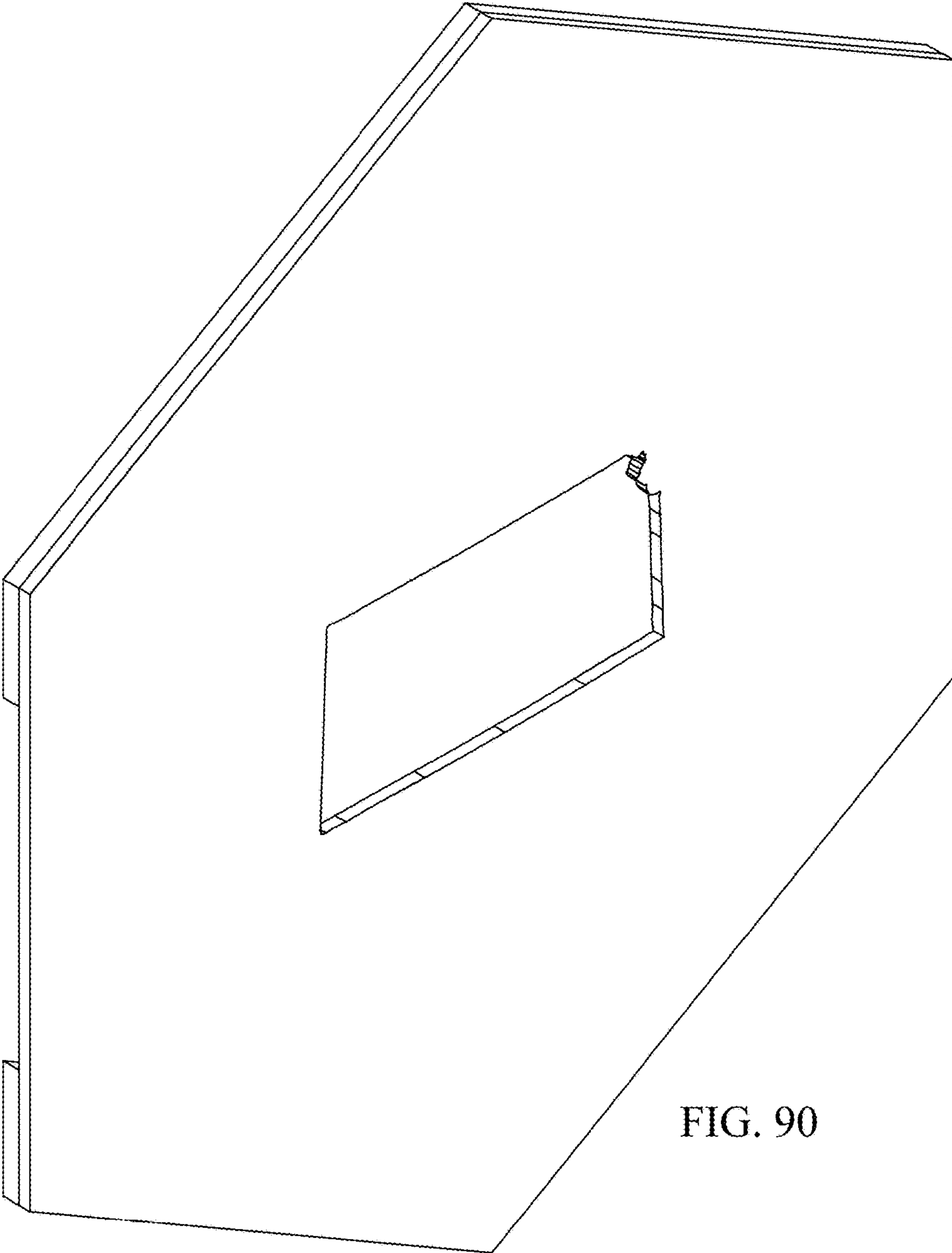

FIG. 90

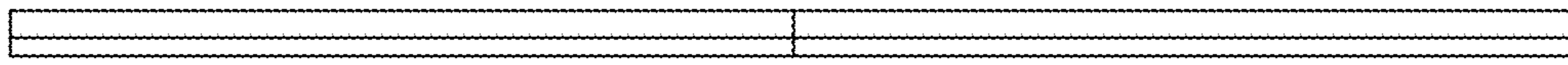

FIG. 91

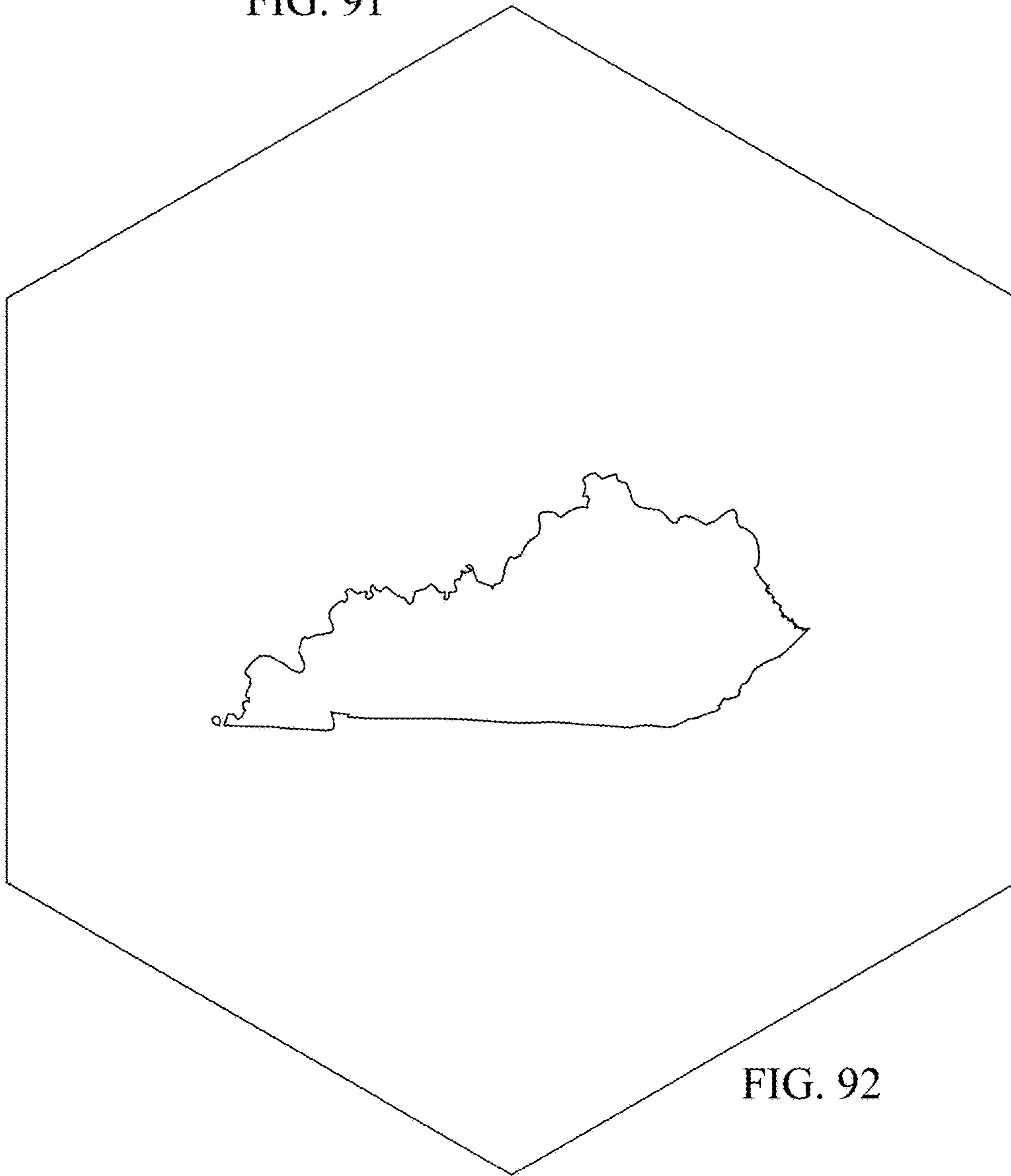

FIG. 92

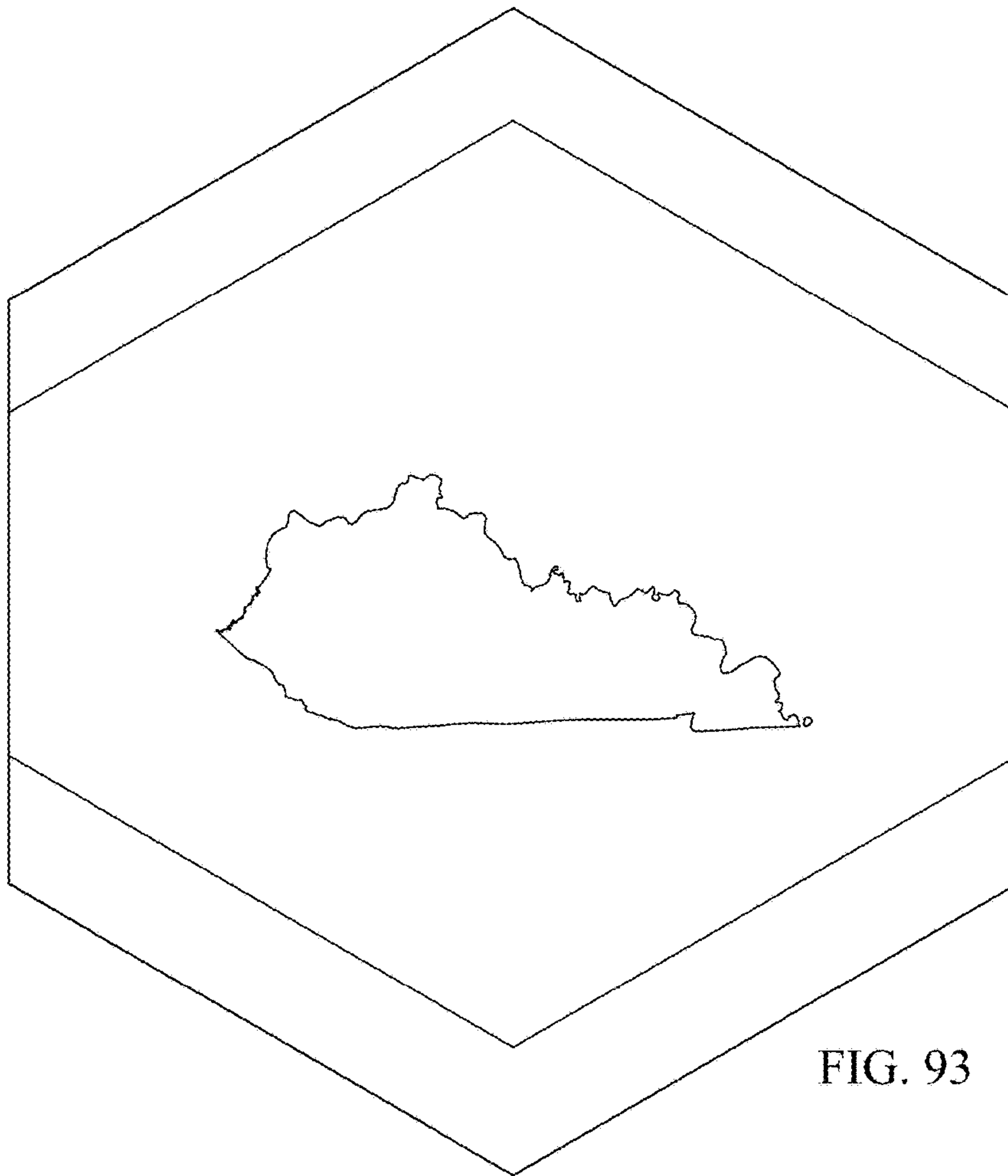

FIG. 93



FIG. 94

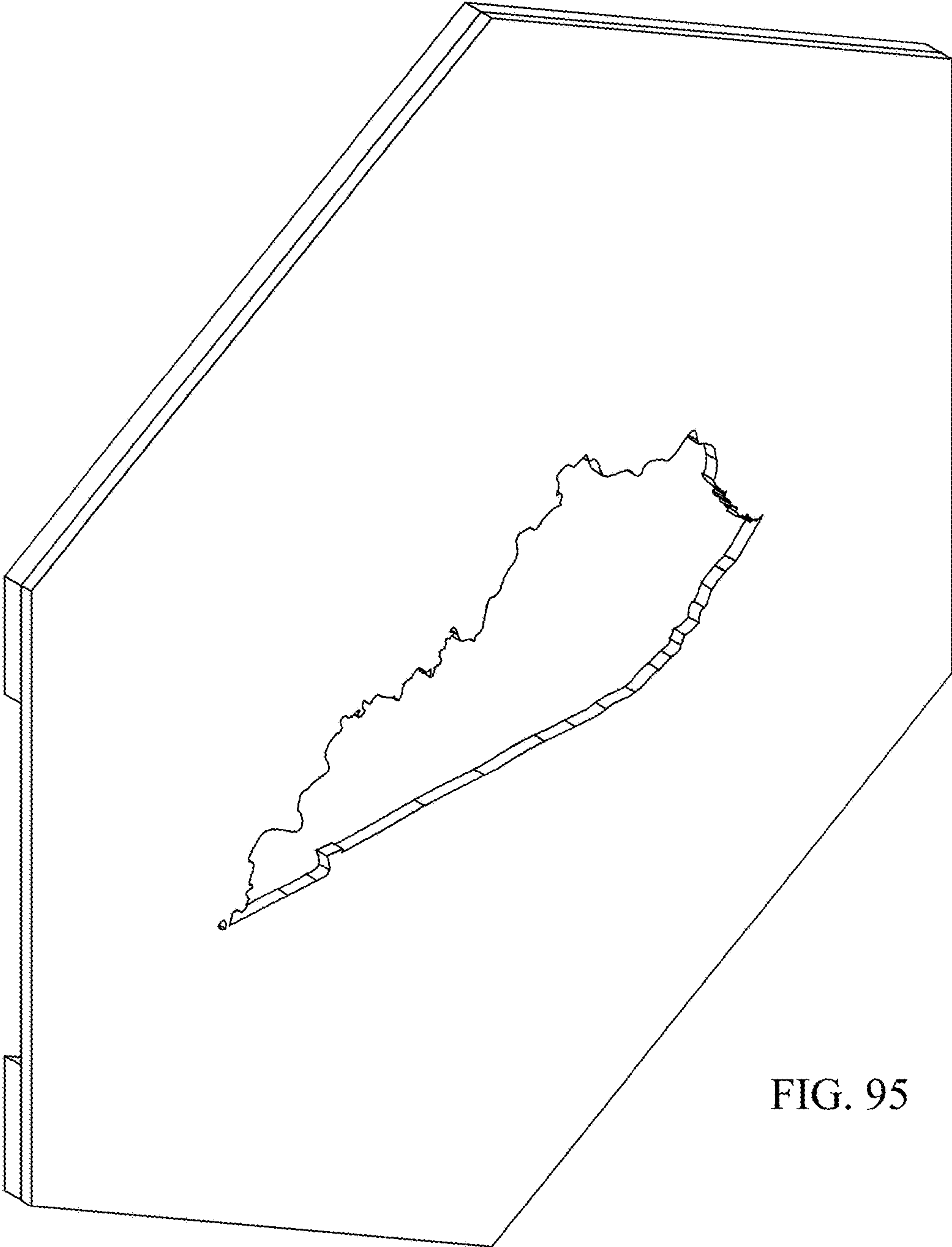

FIG. 95

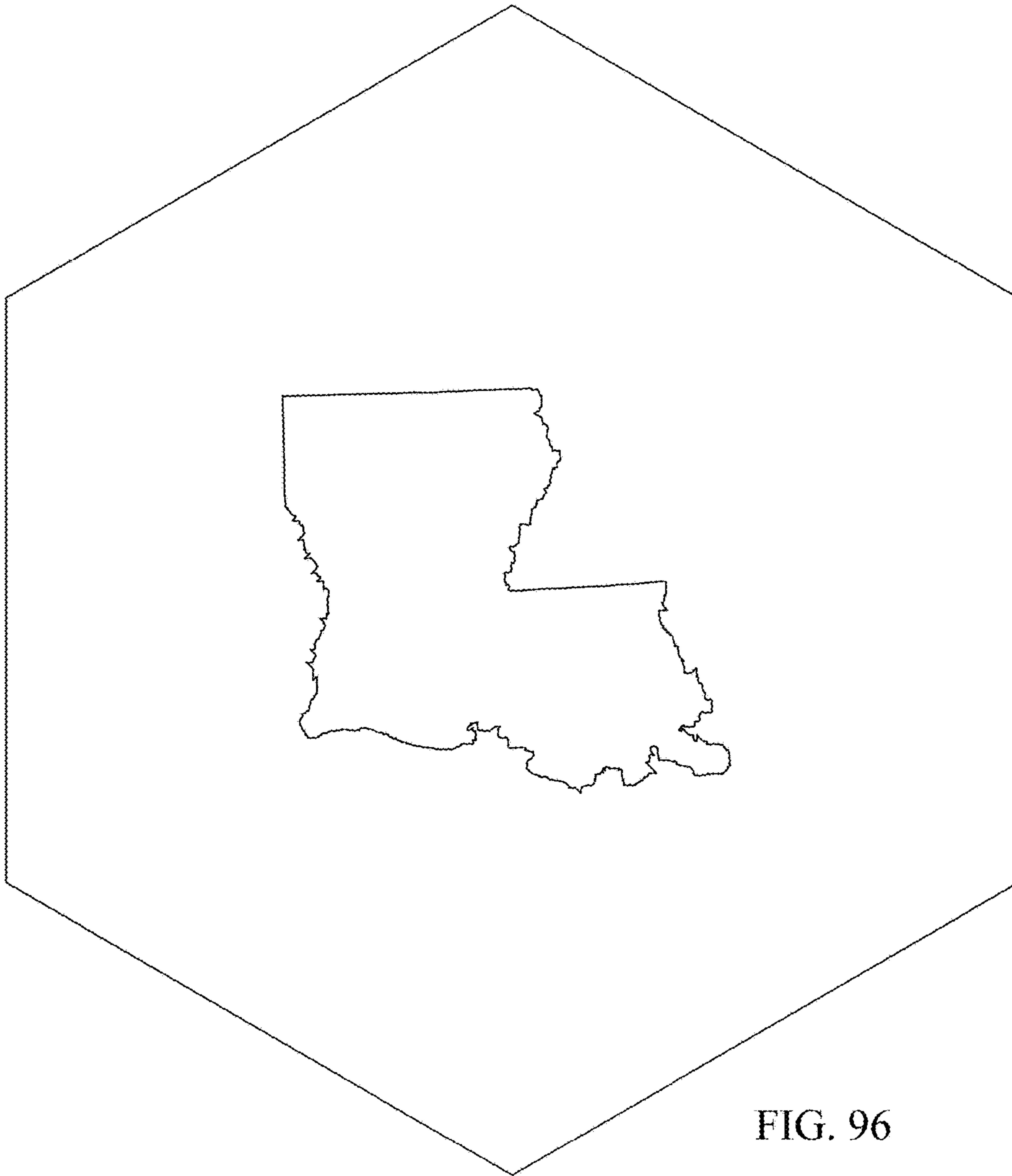

FIG. 96

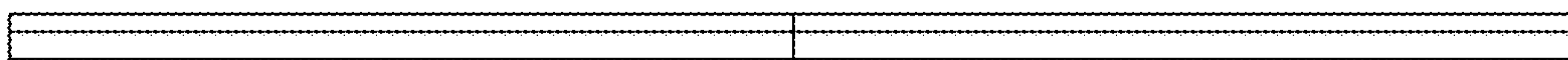

FIG. 97

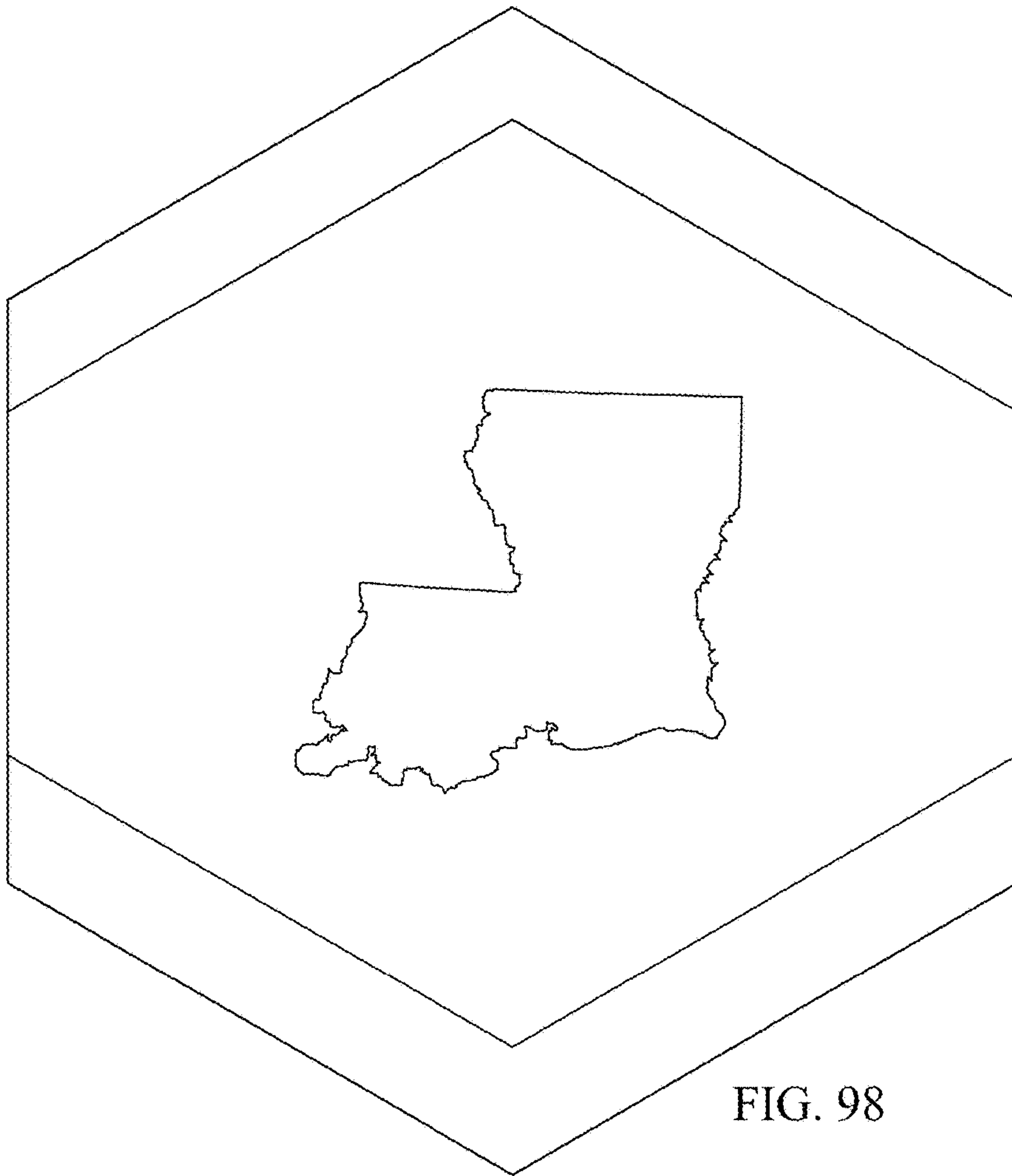

FIG. 98



FIG. 99

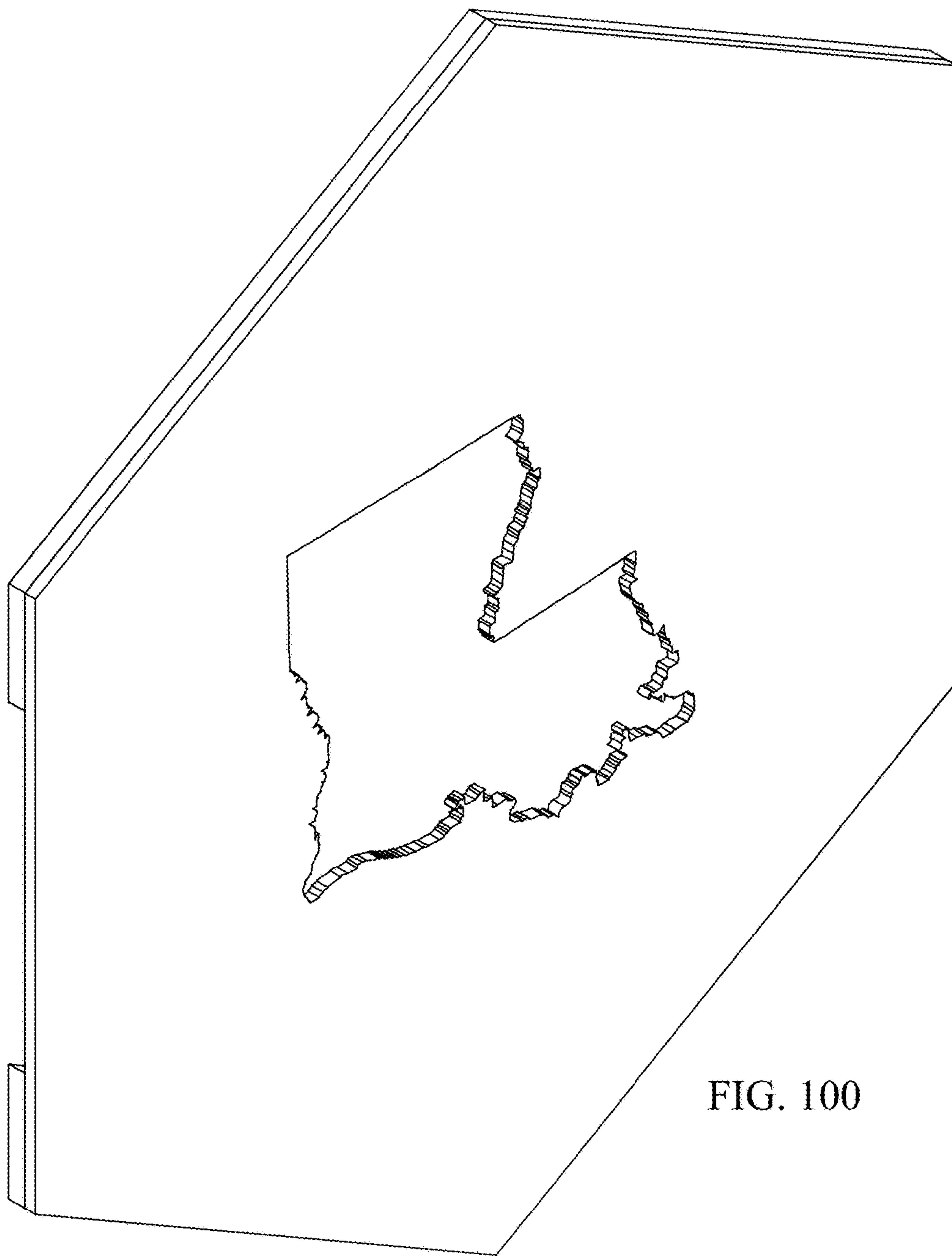

FIG. 100

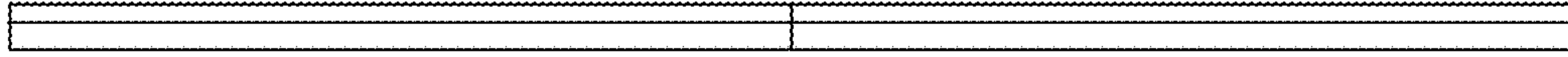

FIG. 101

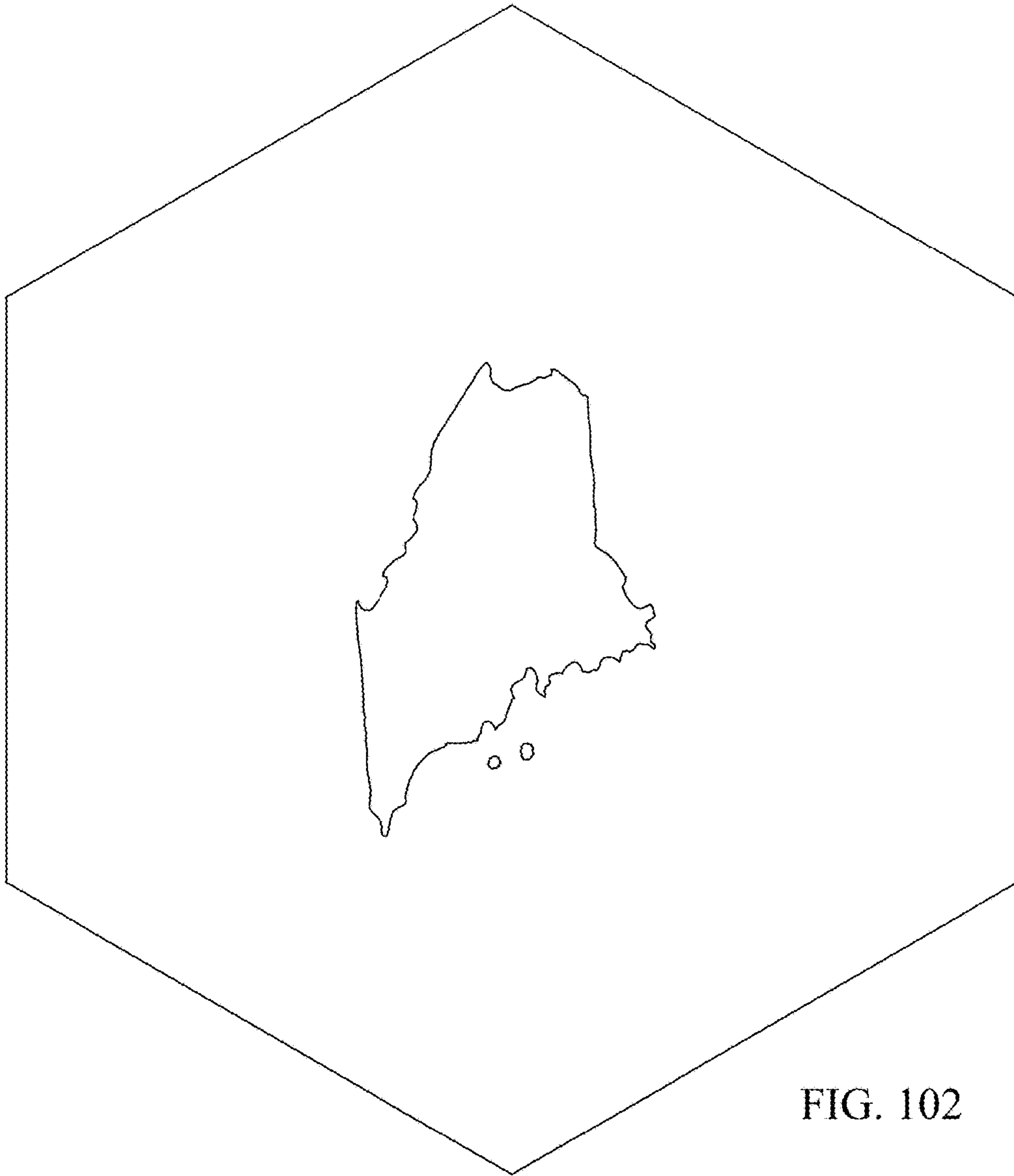

FIG. 102

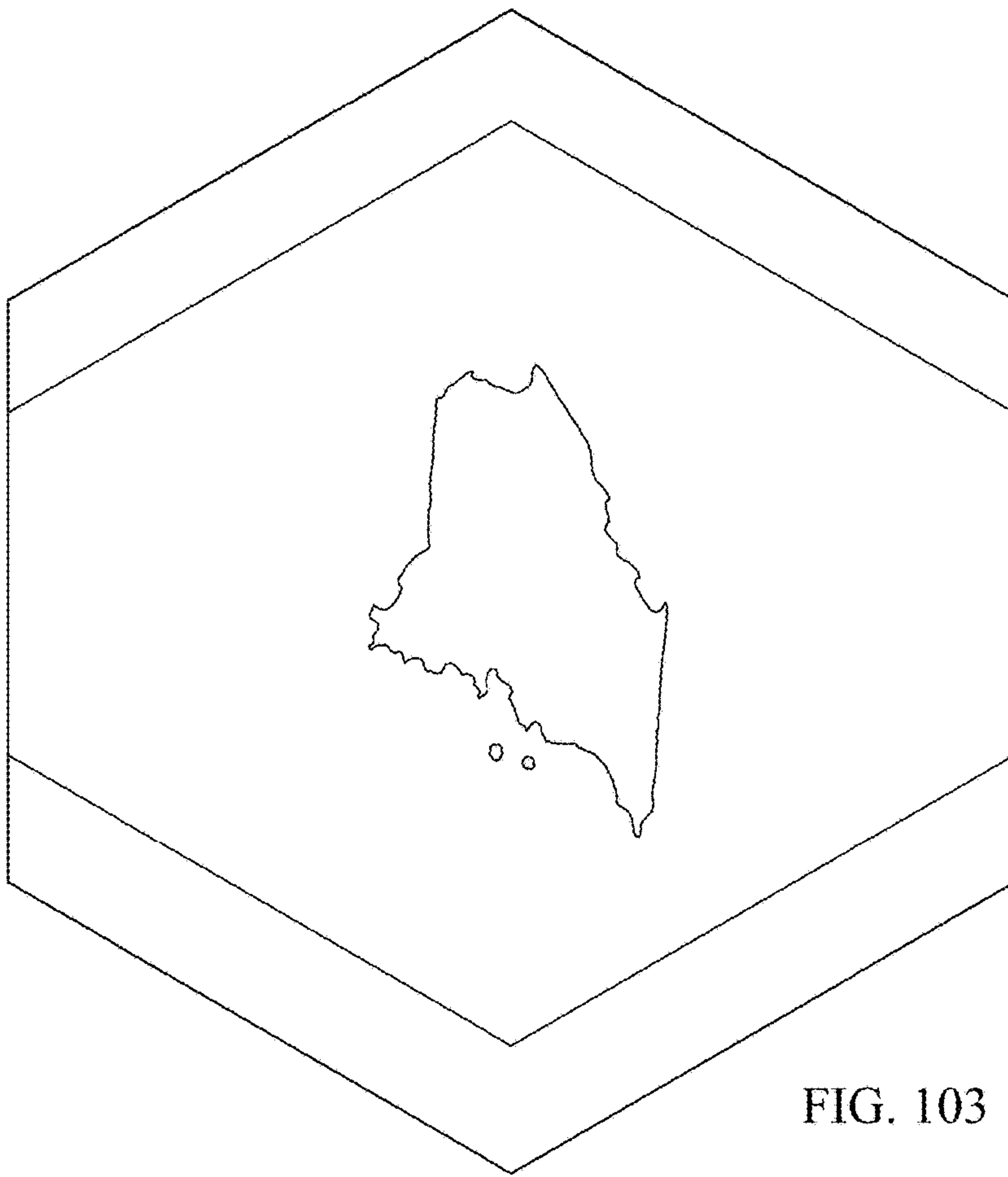

FIG. 103

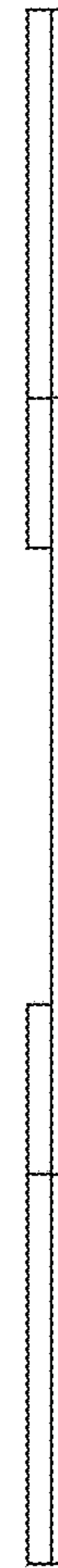

FIG. 104

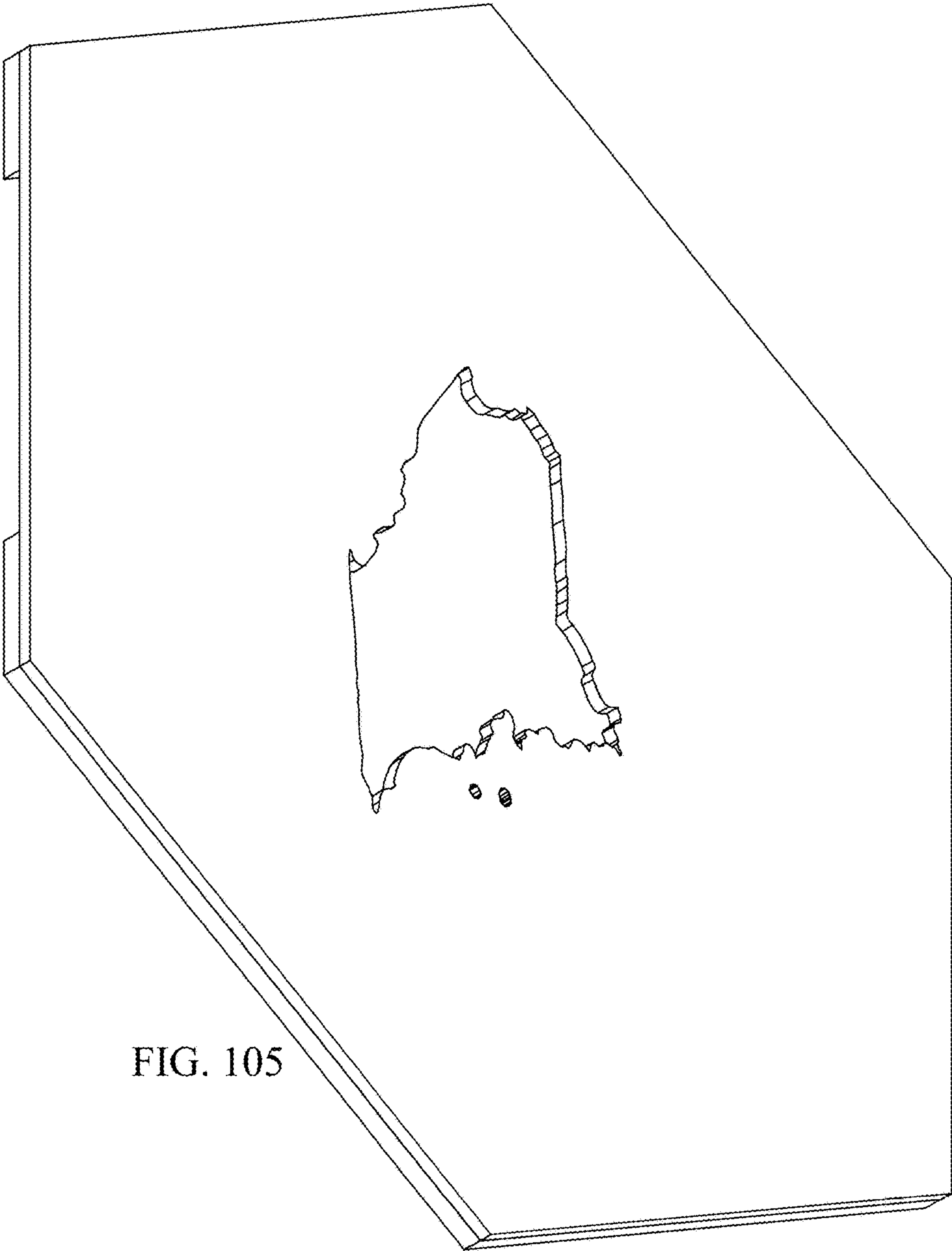

FIG. 105

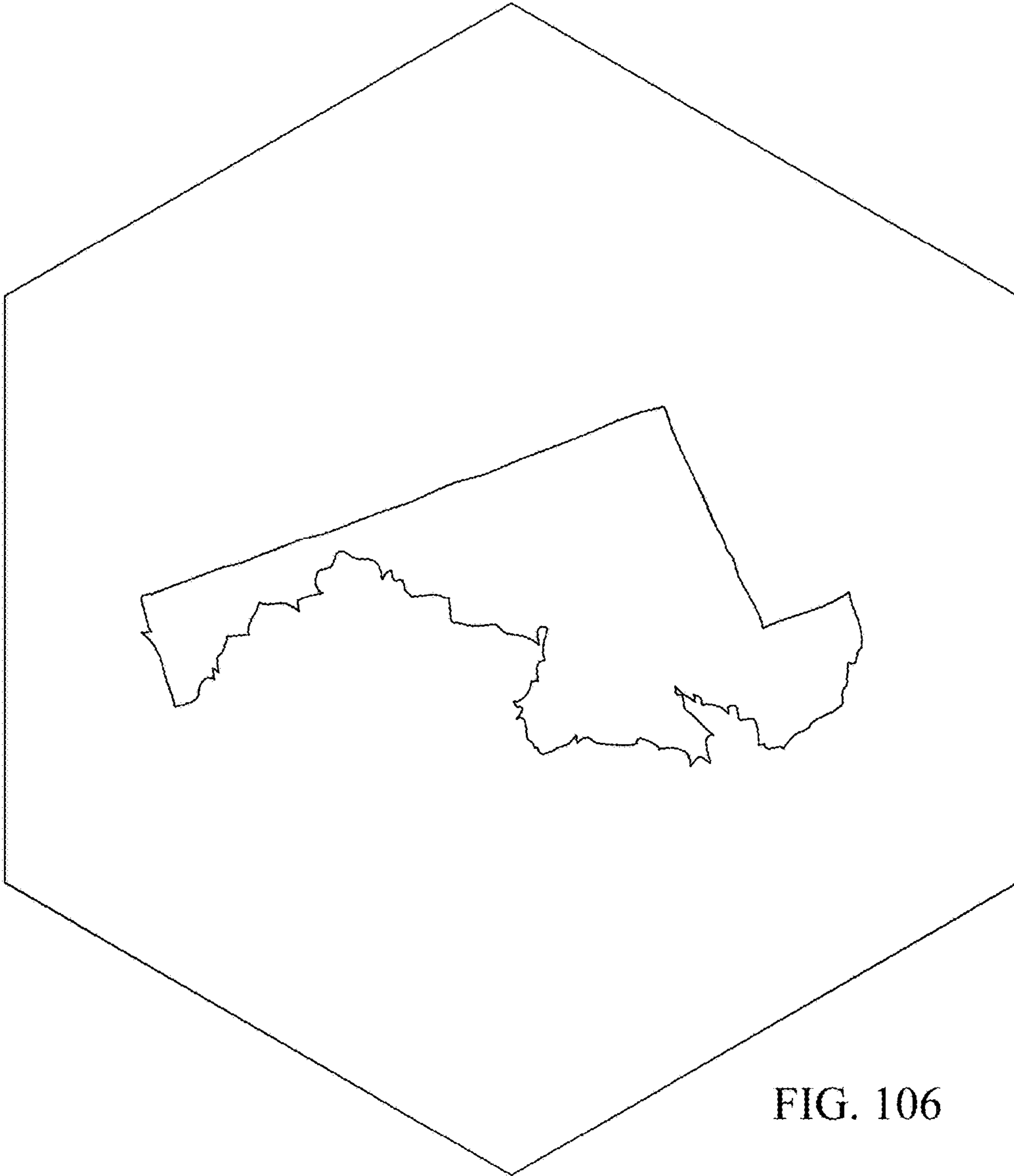

FIG. 106

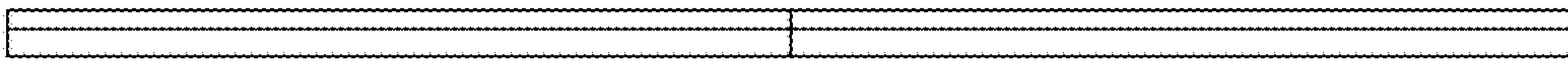

FIG. 107

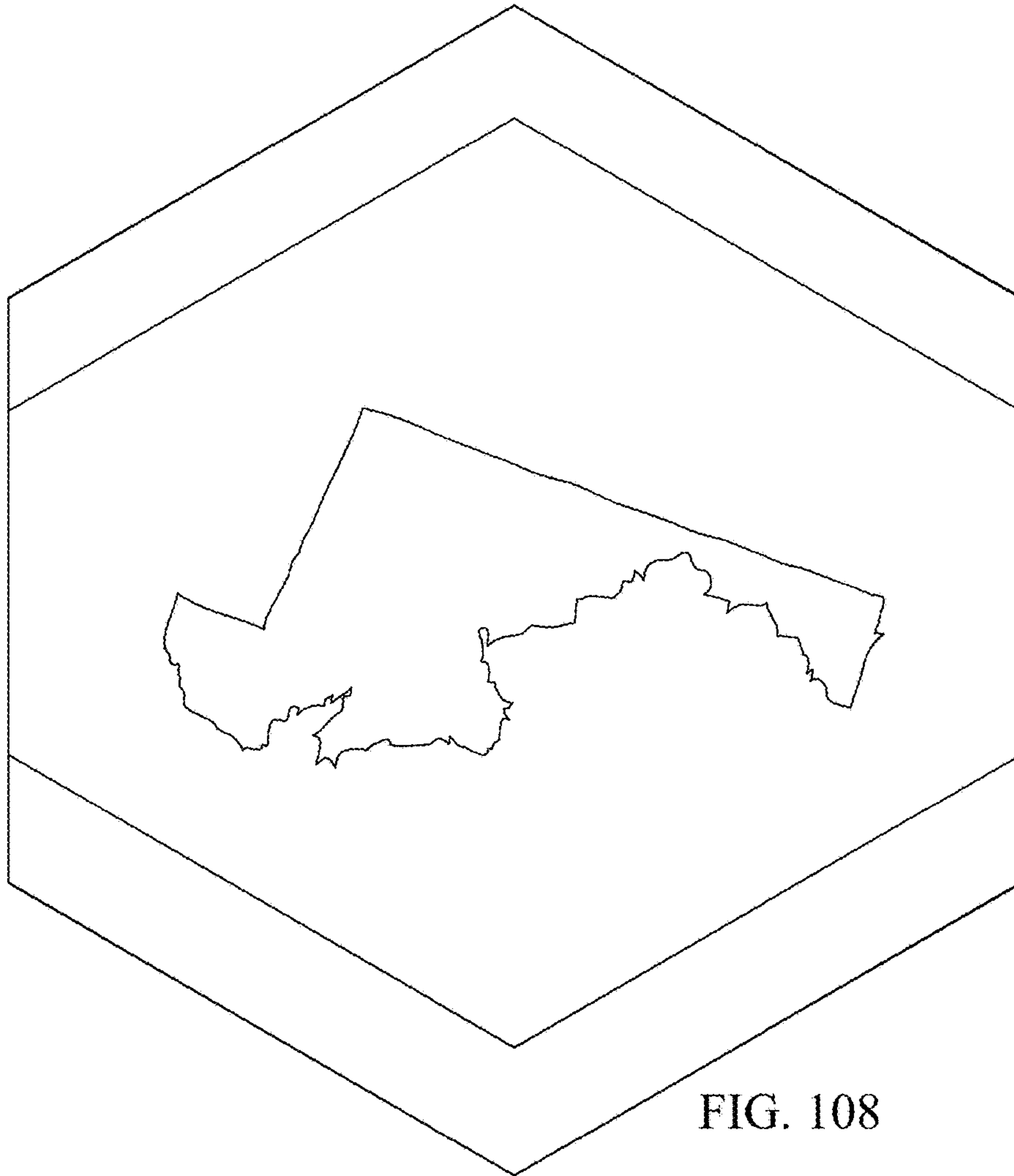

FIG. 108

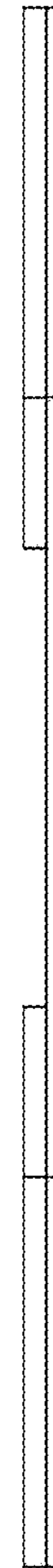

FIG. 109

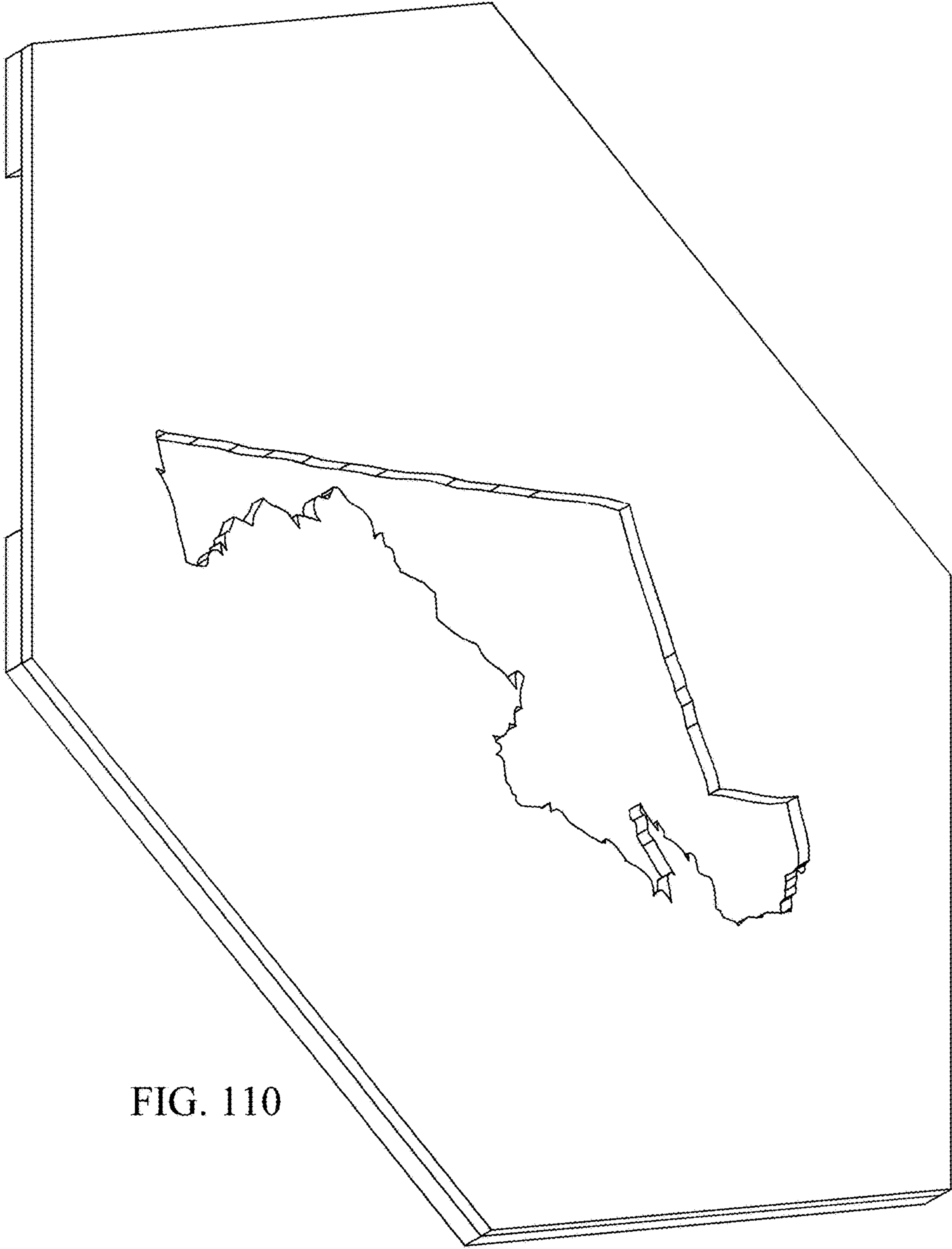

FIG. 110

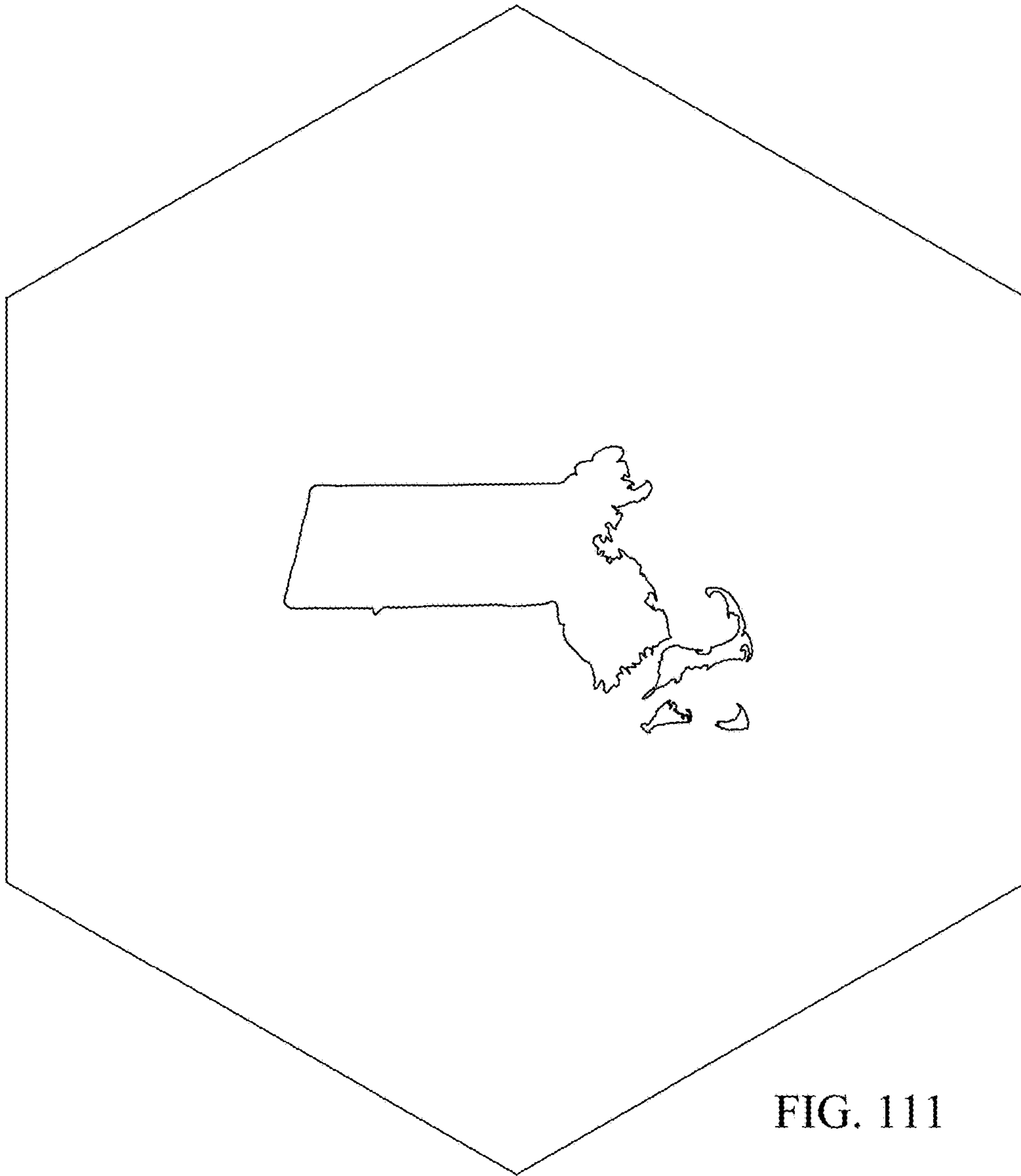

FIG. 111

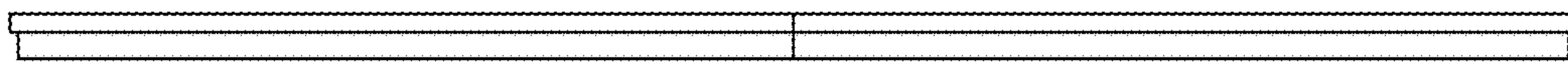

FIG. 112

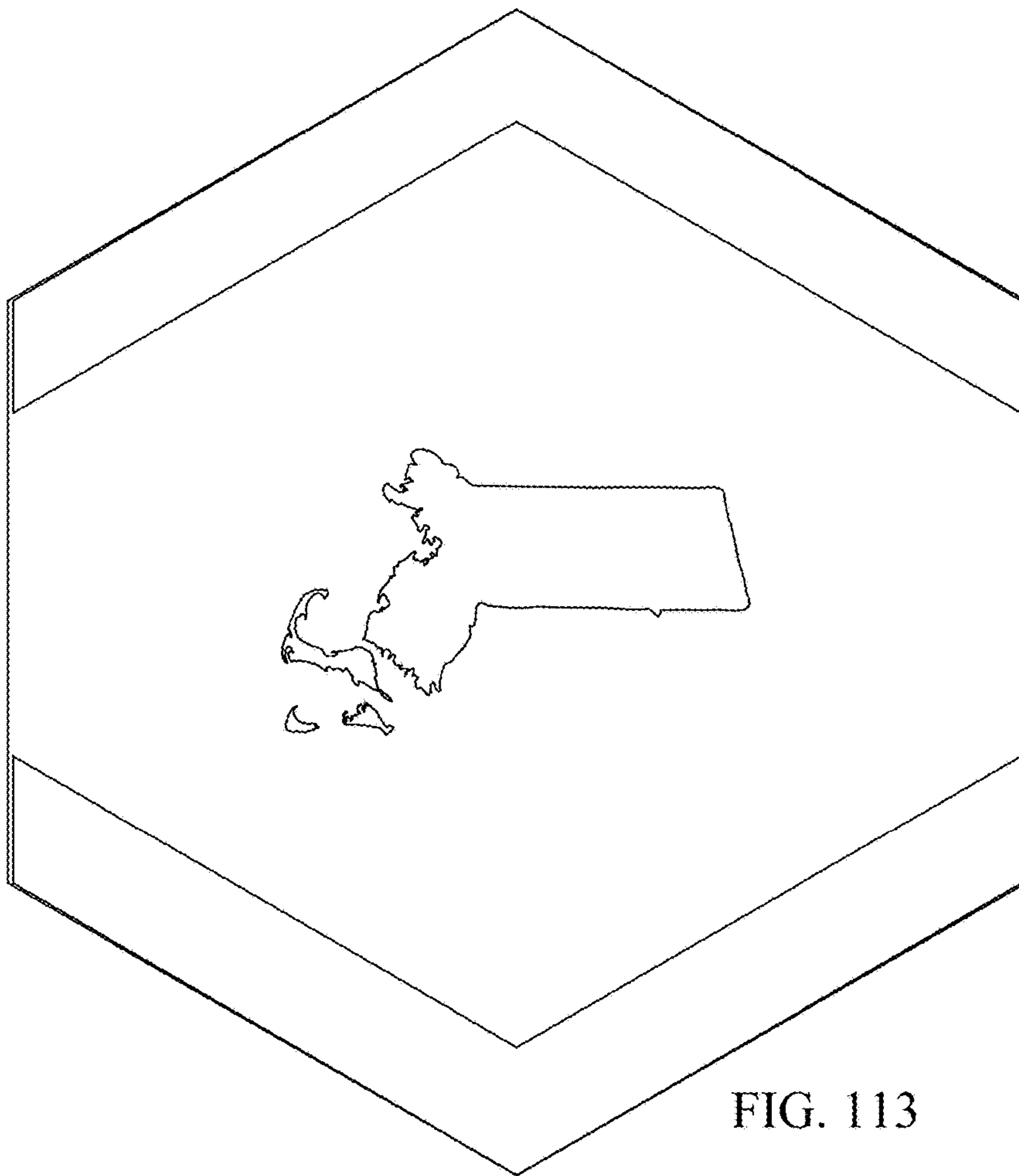

FIG. 113



FIG. 114

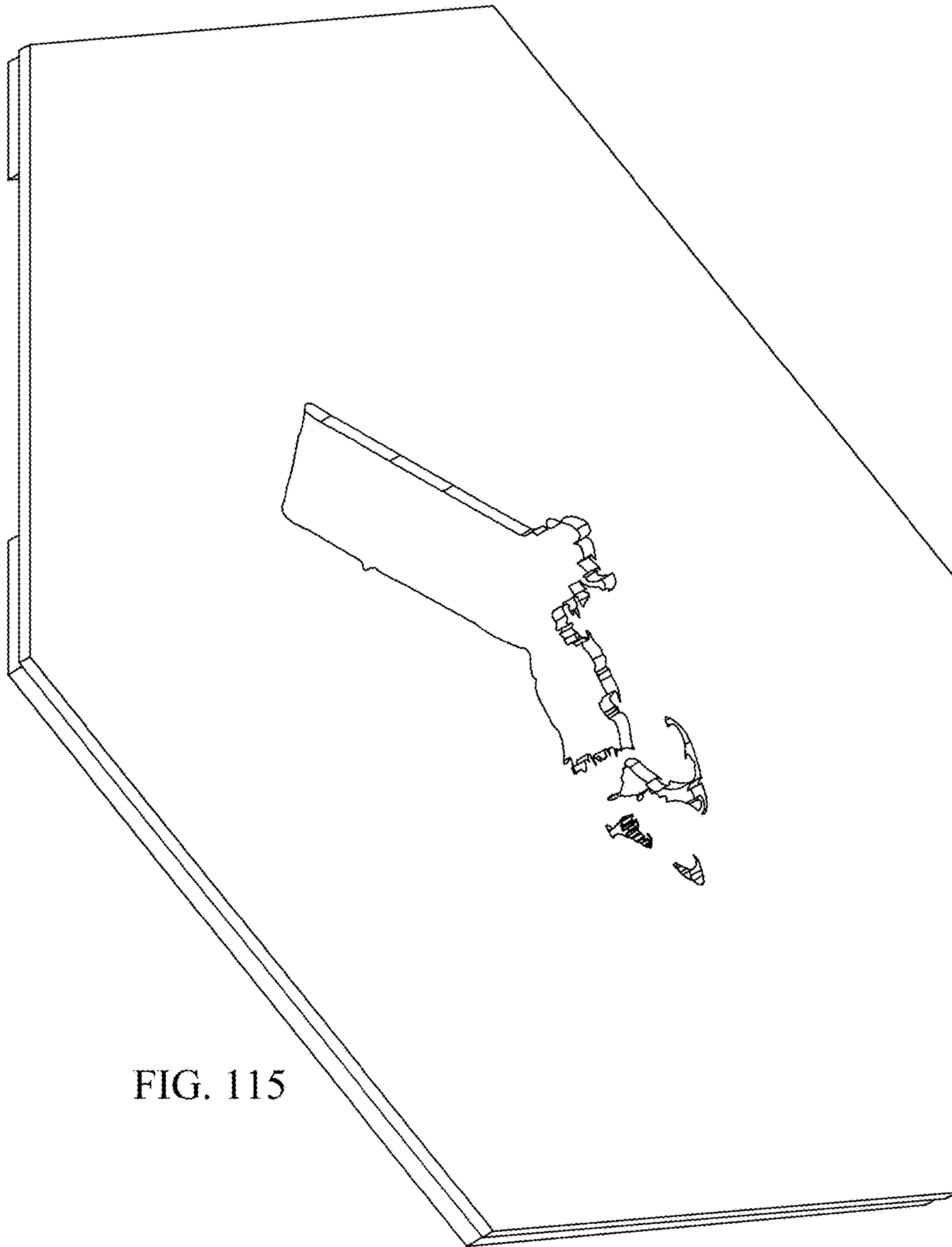

FIG. 115

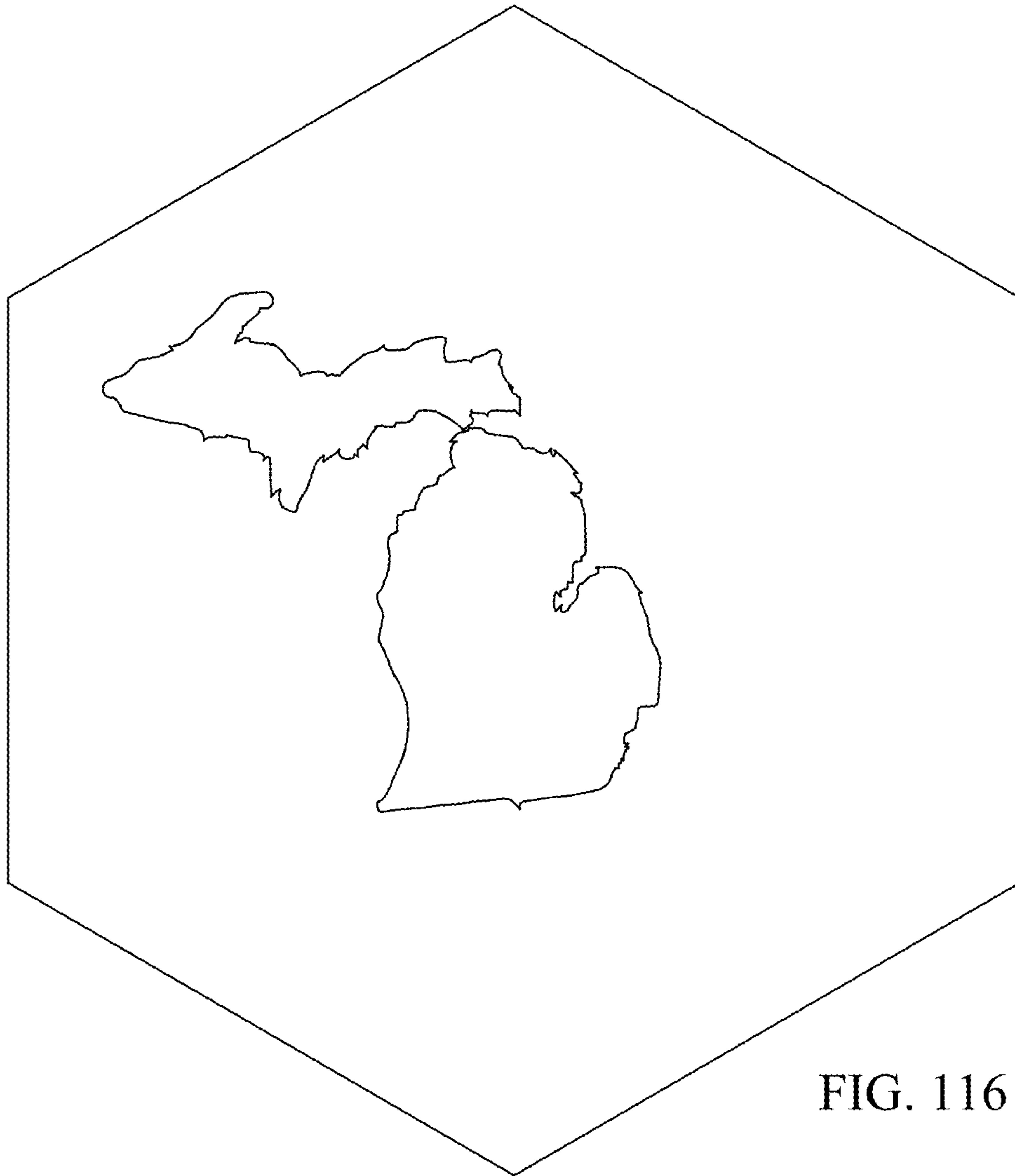

FIG. 116



FIG. 117

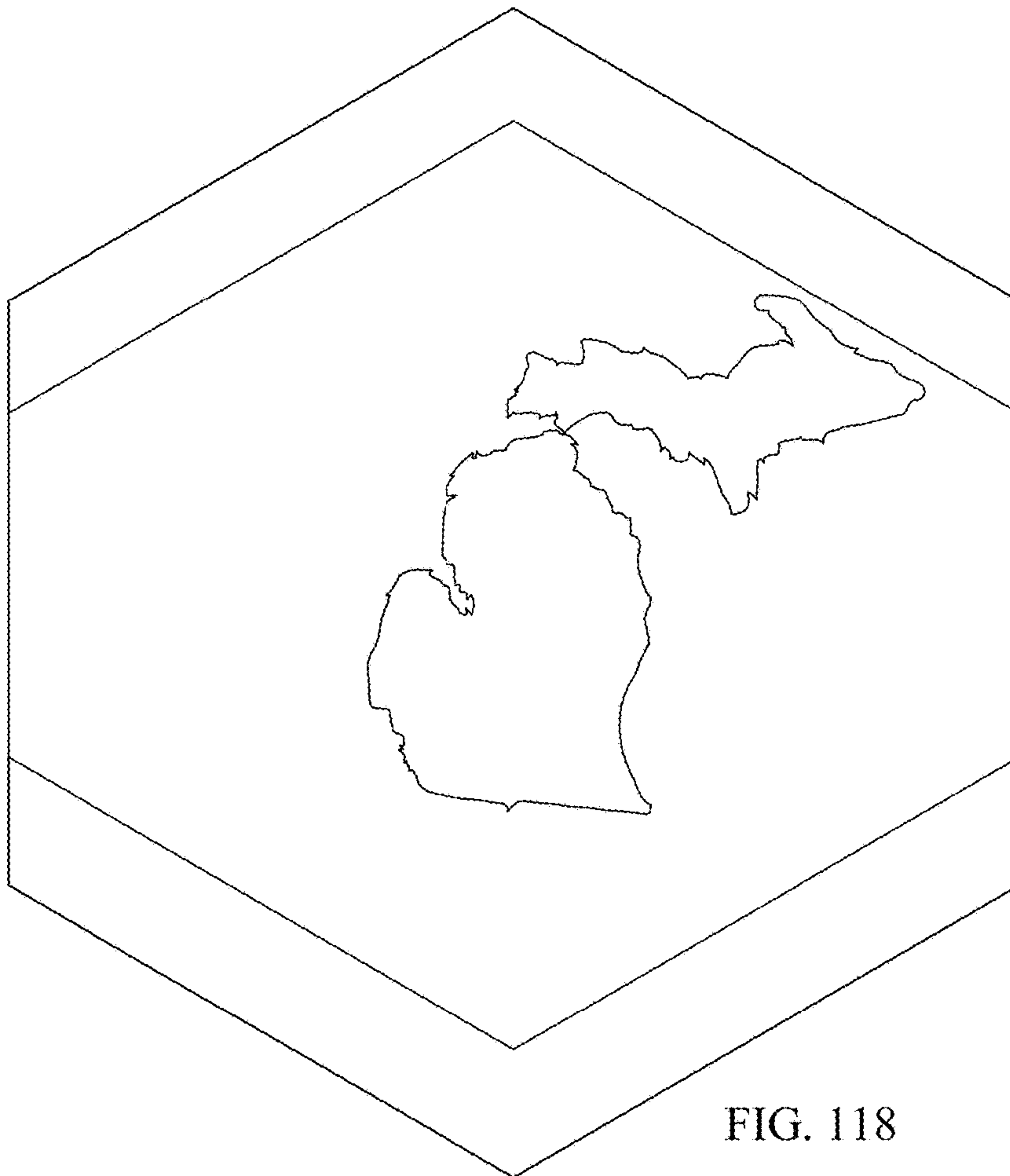

FIG. 118



FIG. 119

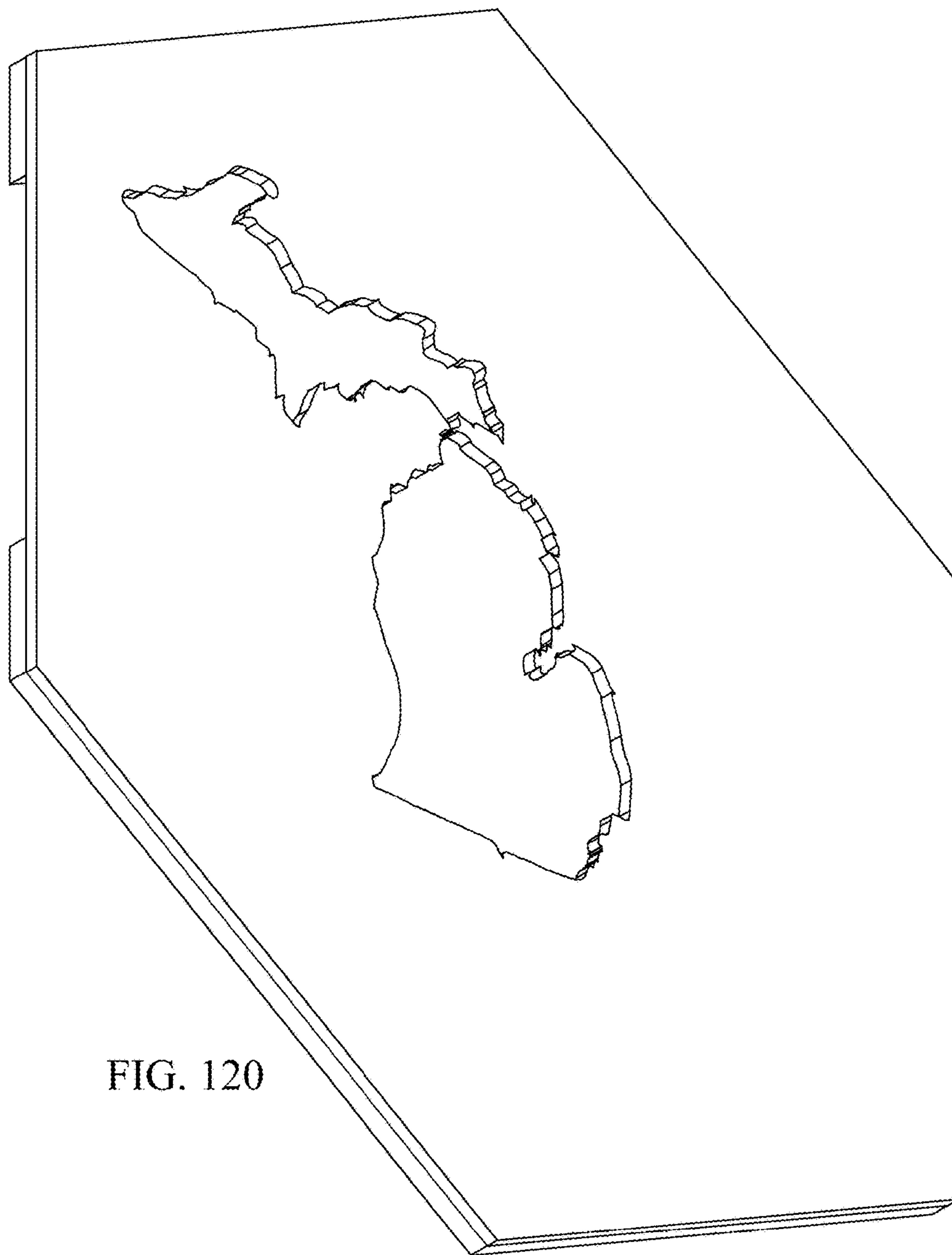

FIG. 120

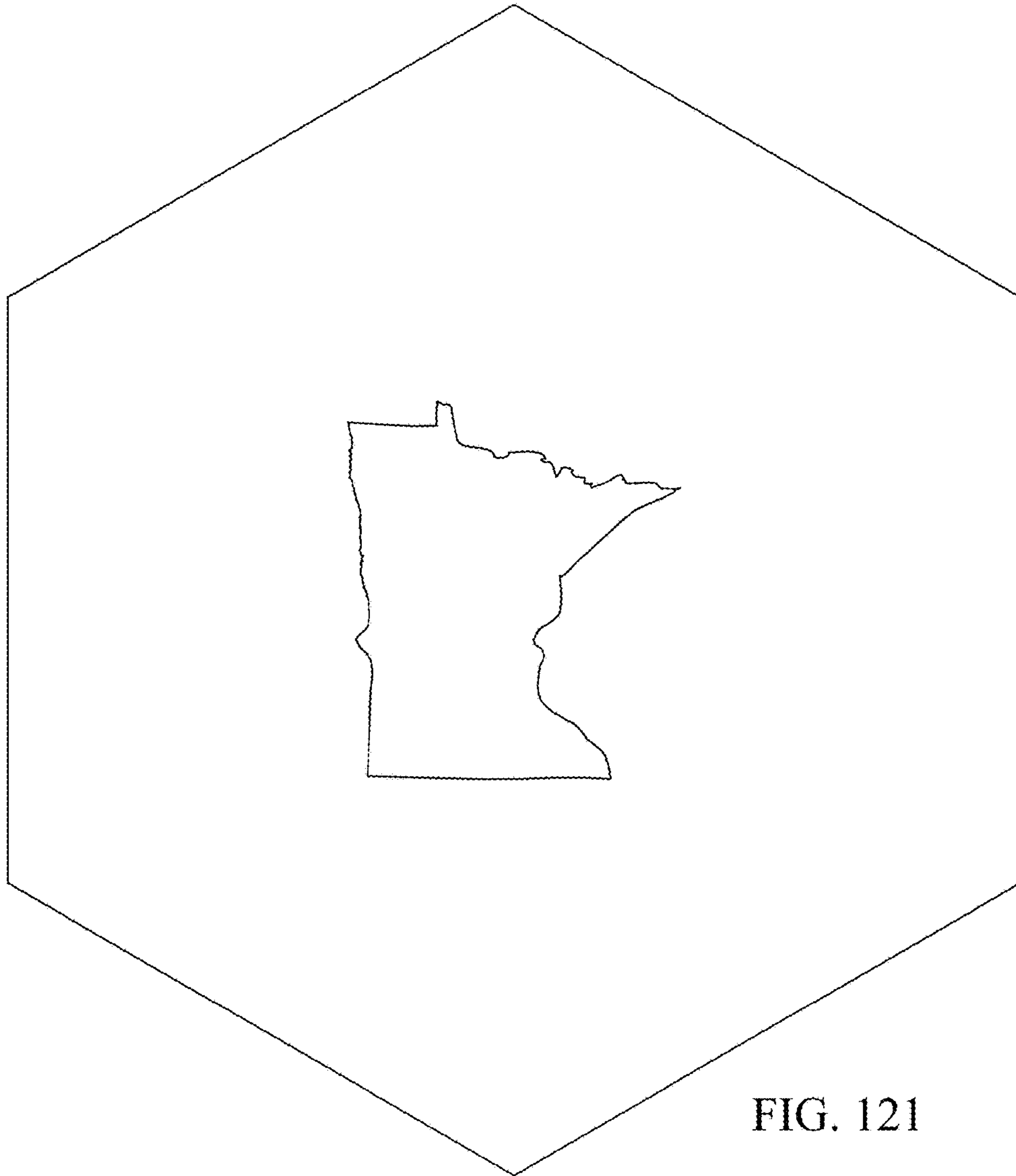

FIG. 121

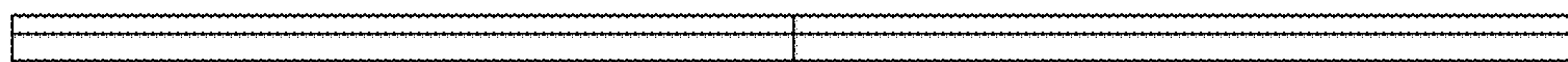

FIG. 122

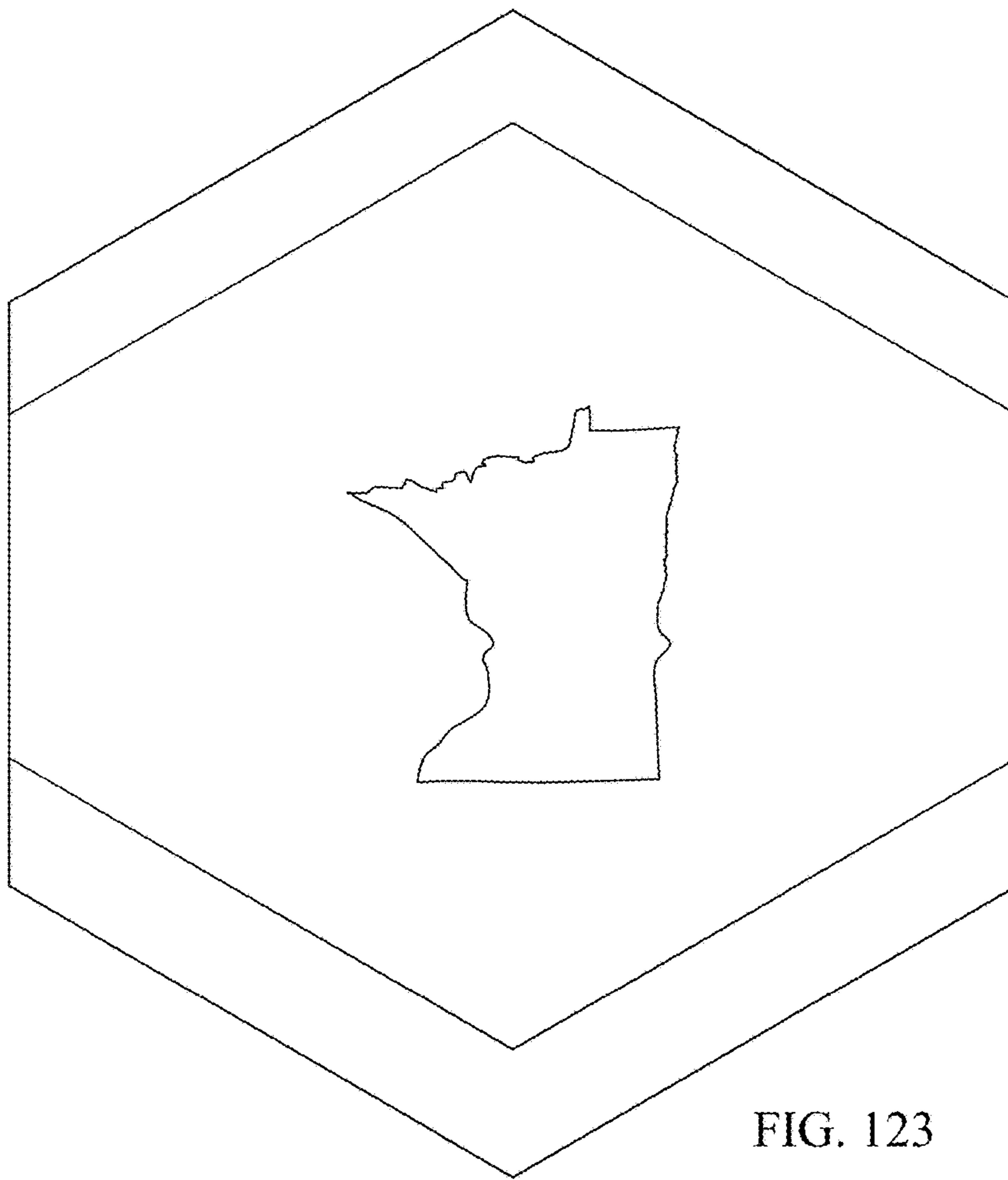

FIG. 123

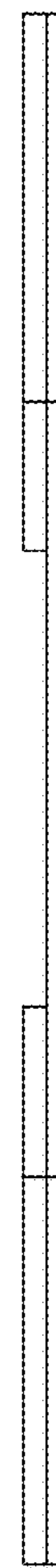

FIG. 124

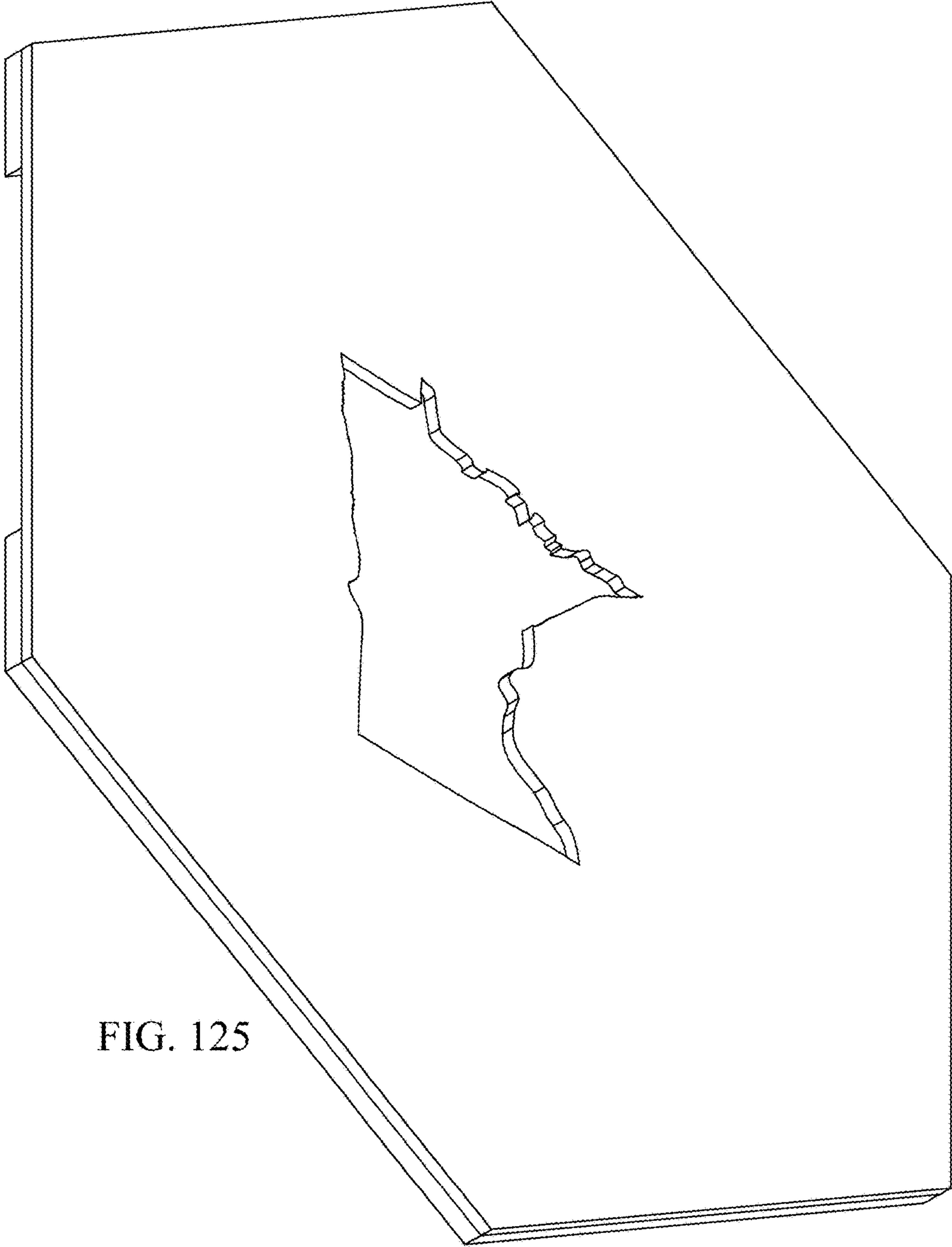

FIG. 125

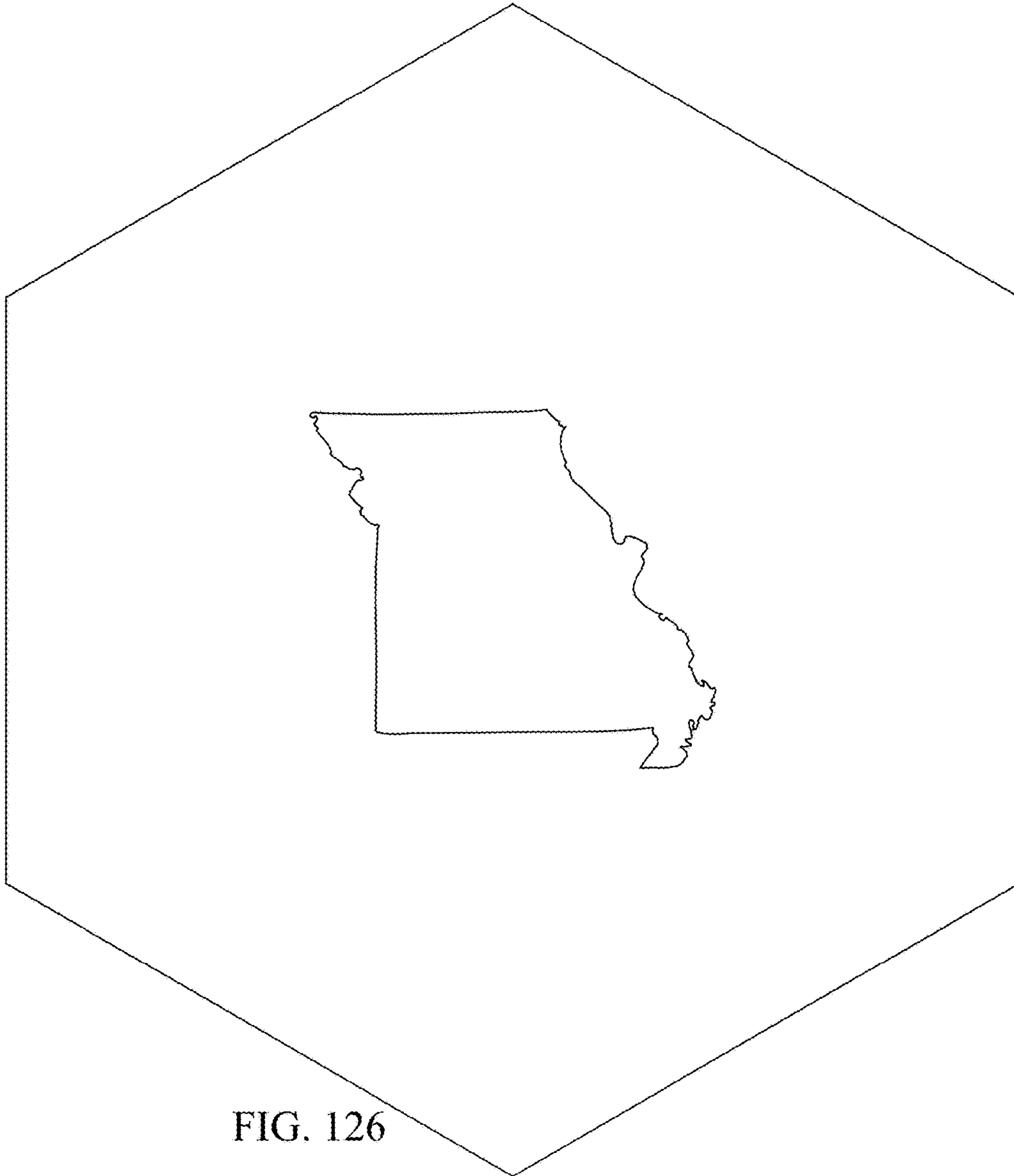

FIG. 126

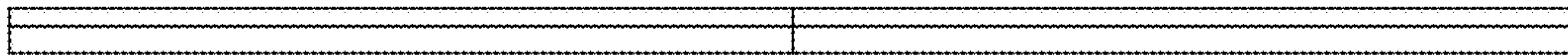

FIG. 127

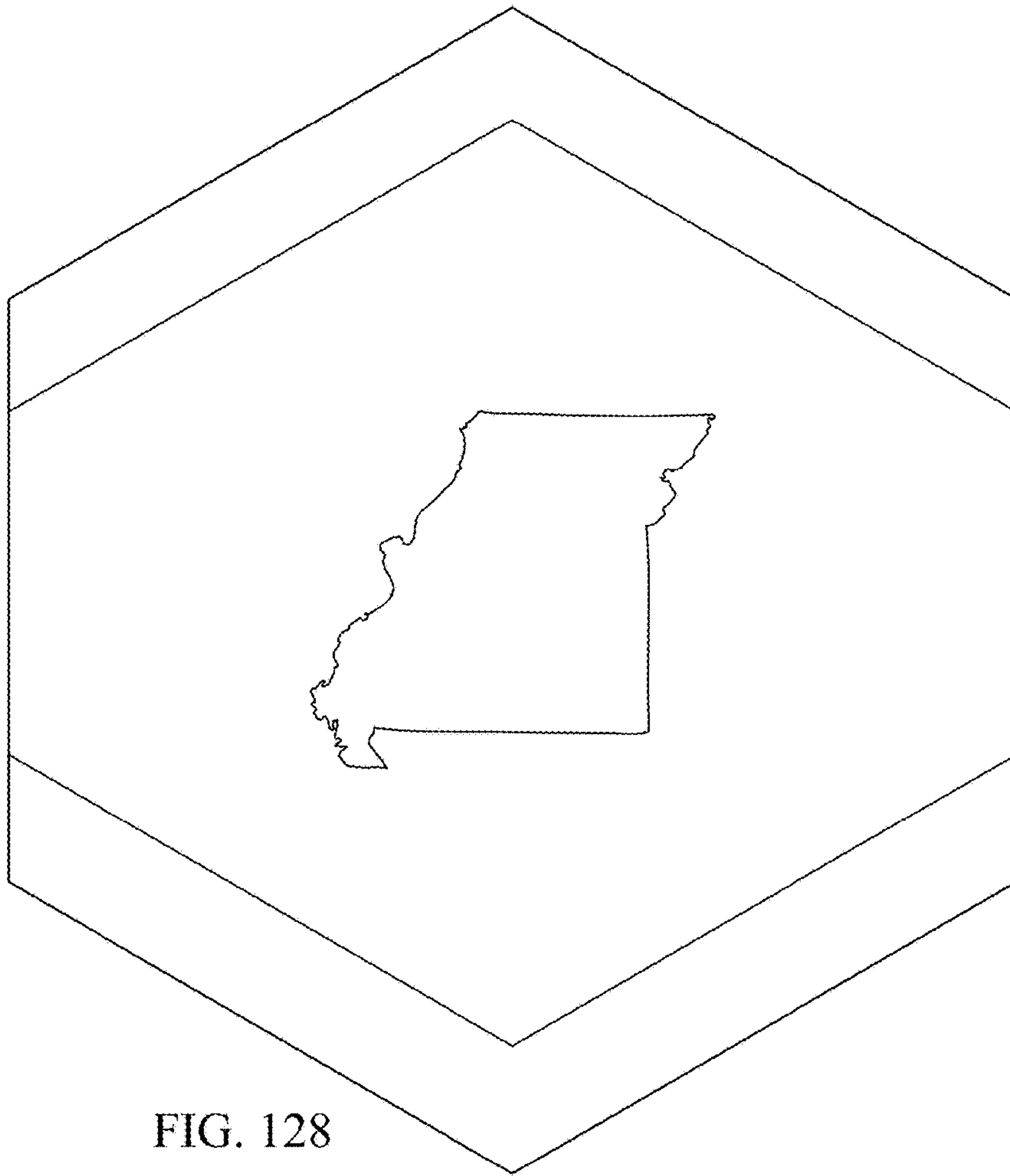

FIG. 128



FIG. 129

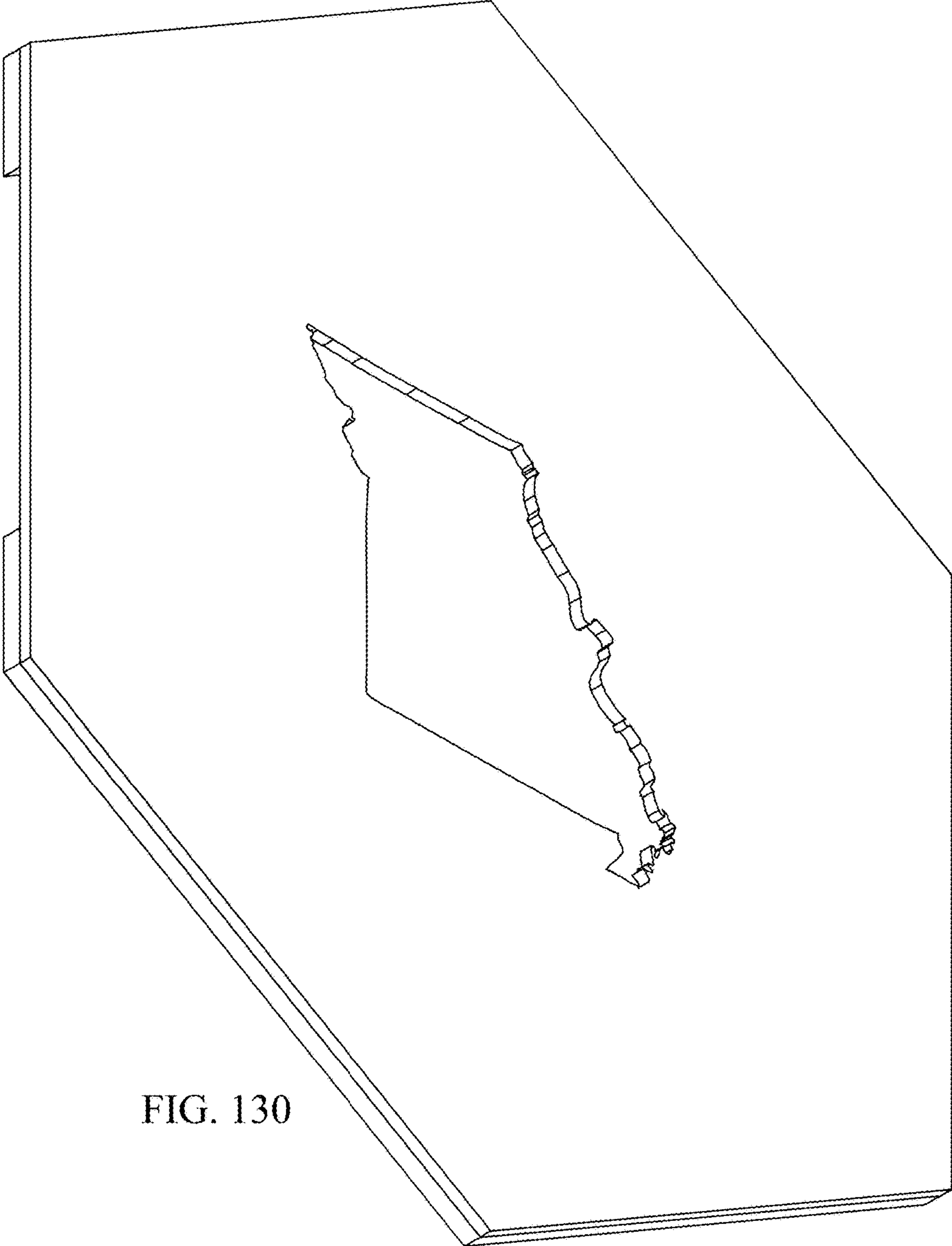

FIG. 130

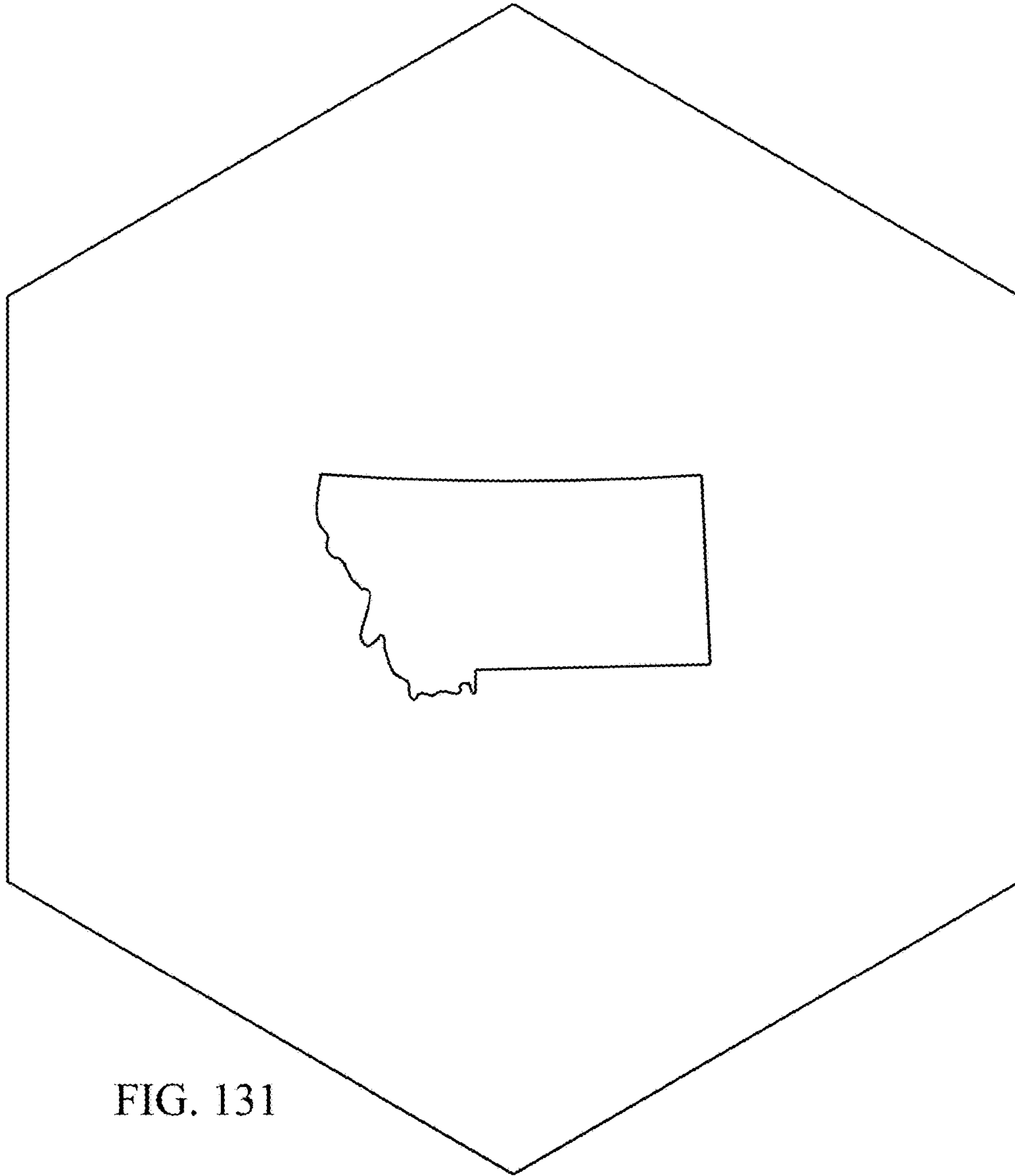

FIG. 131



FIG. 132

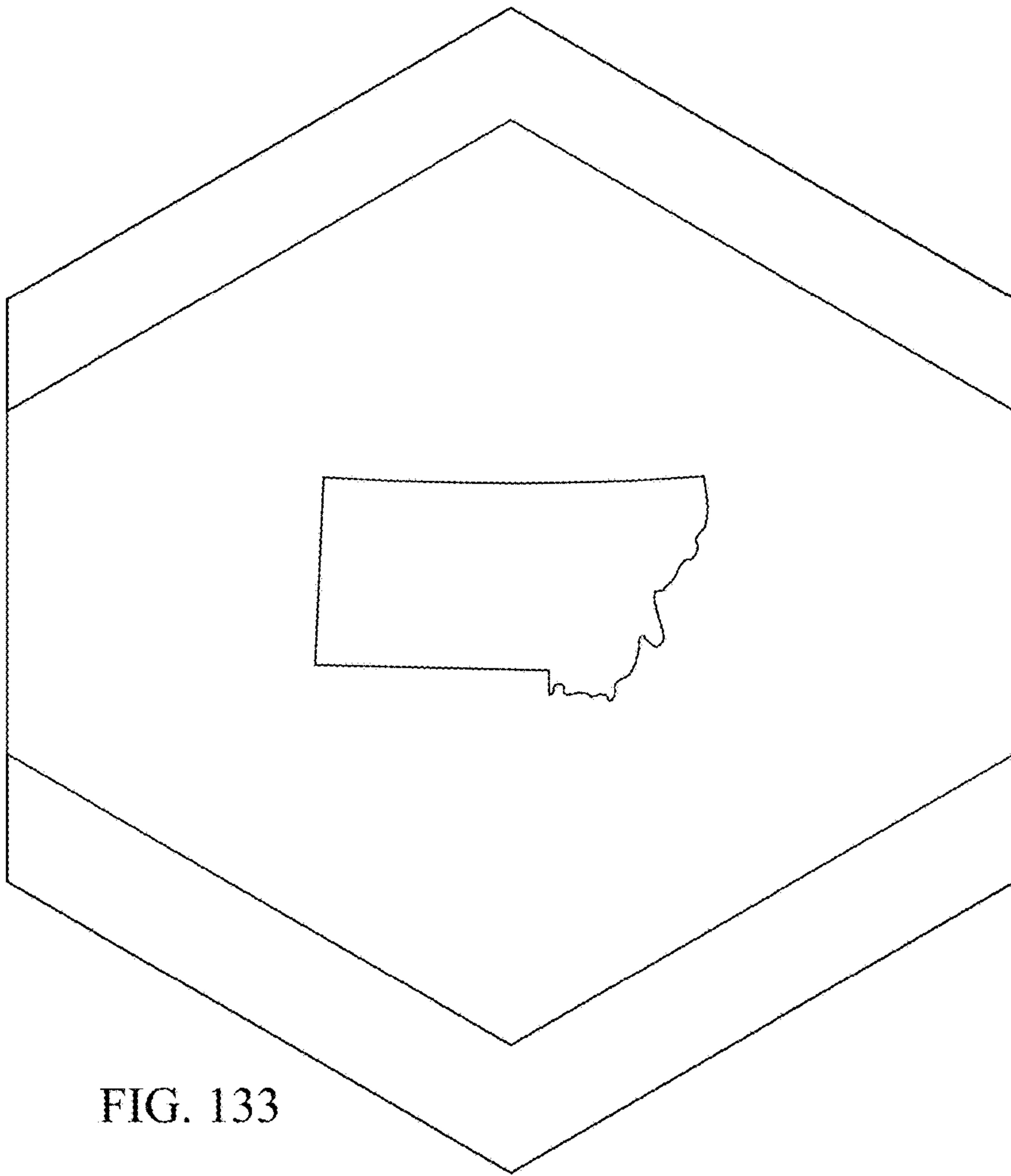

FIG. 133



FIG. 134

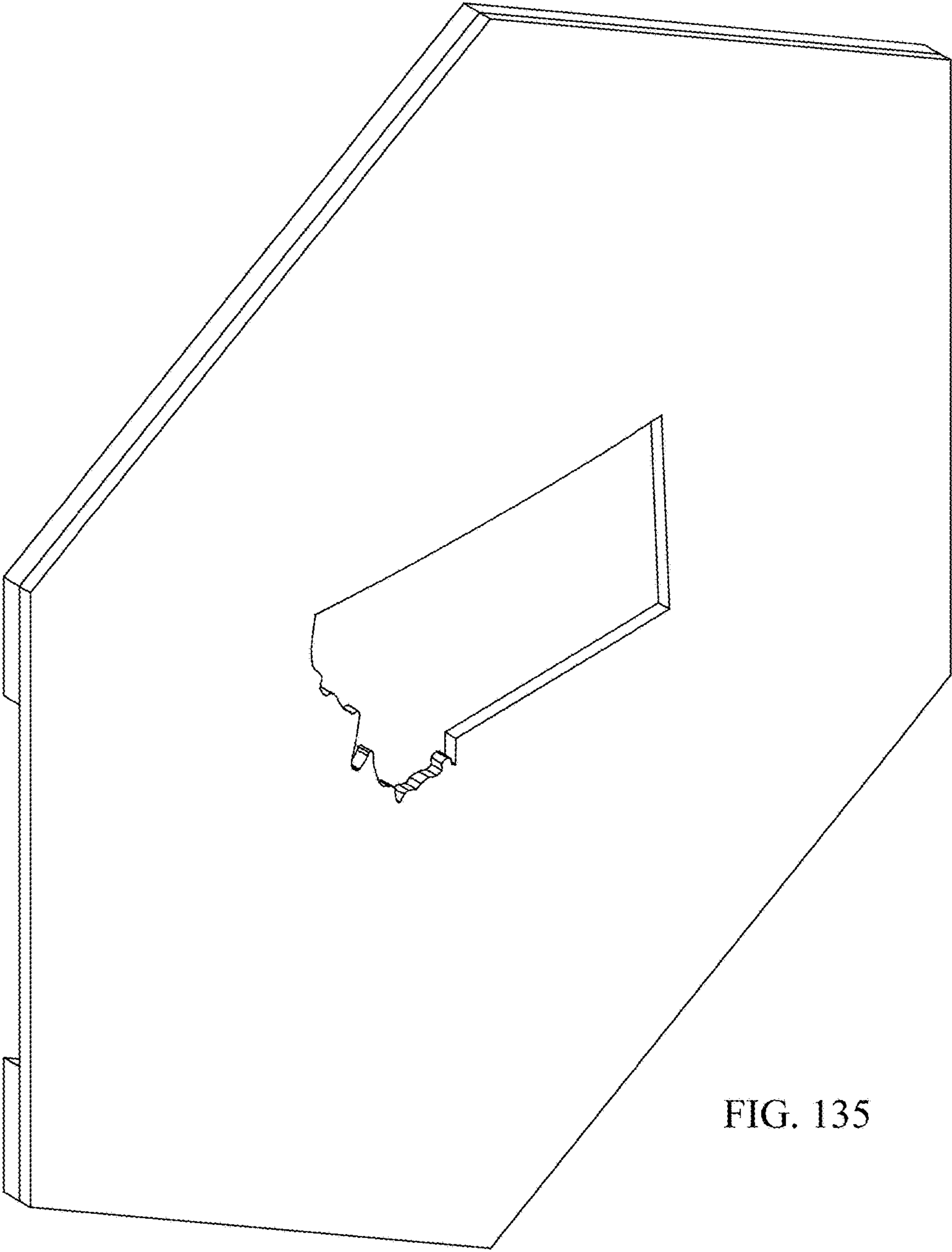

FIG. 135

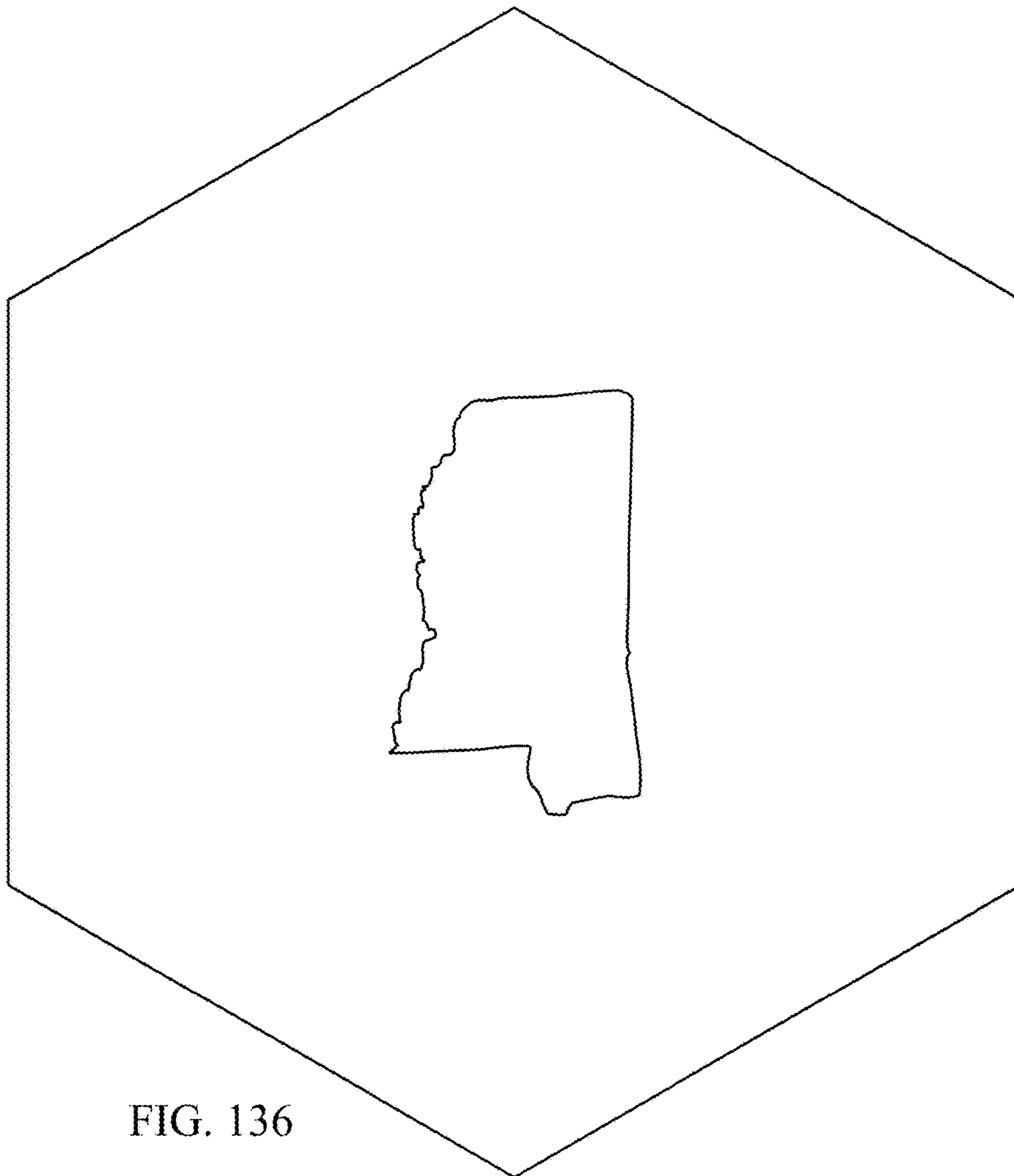

FIG. 136

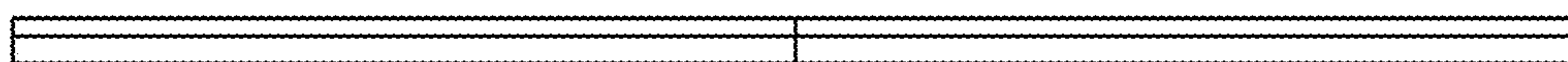

FIG. 137

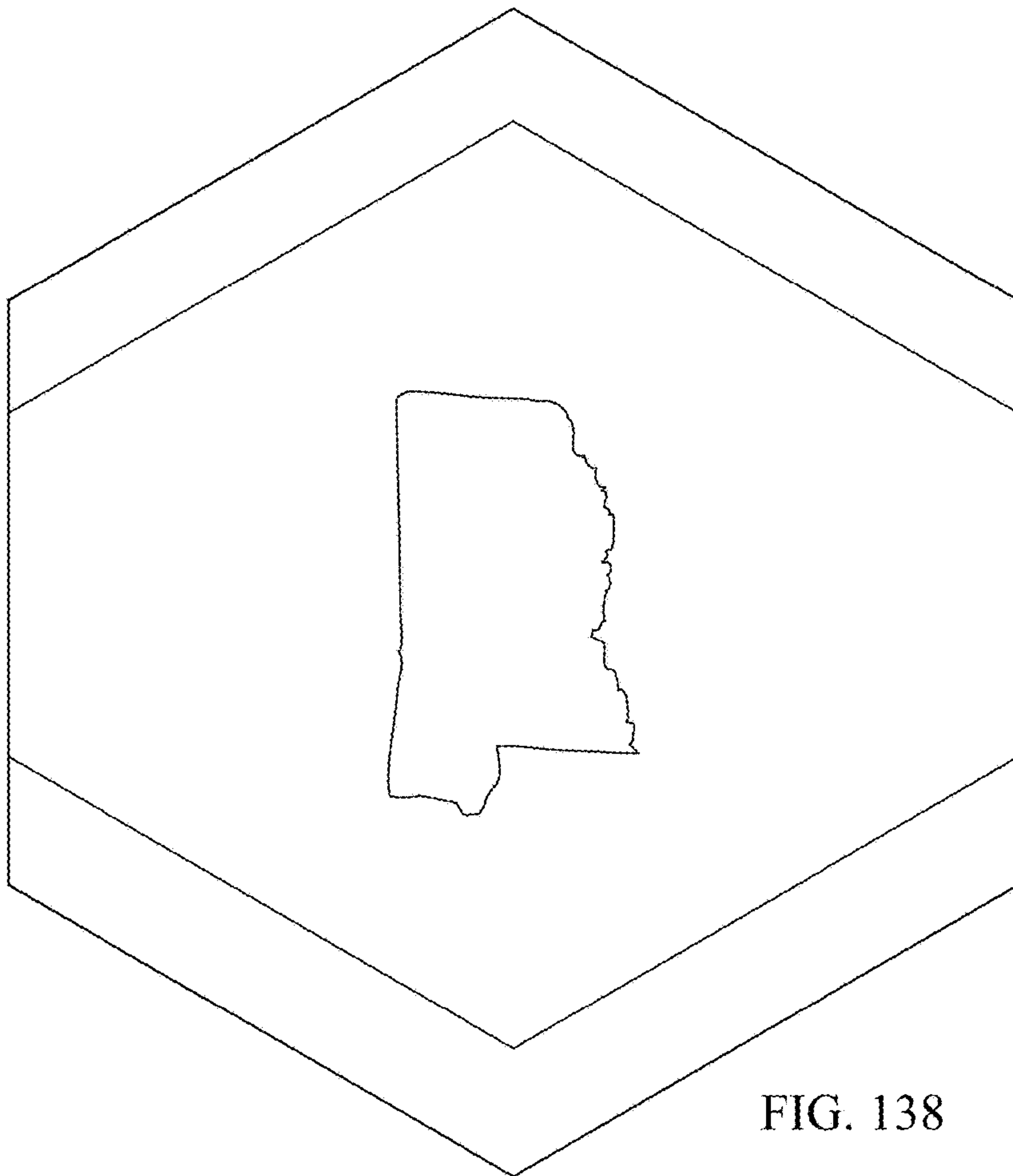

FIG. 138

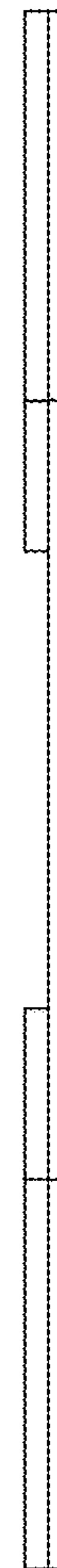

FIG. 139

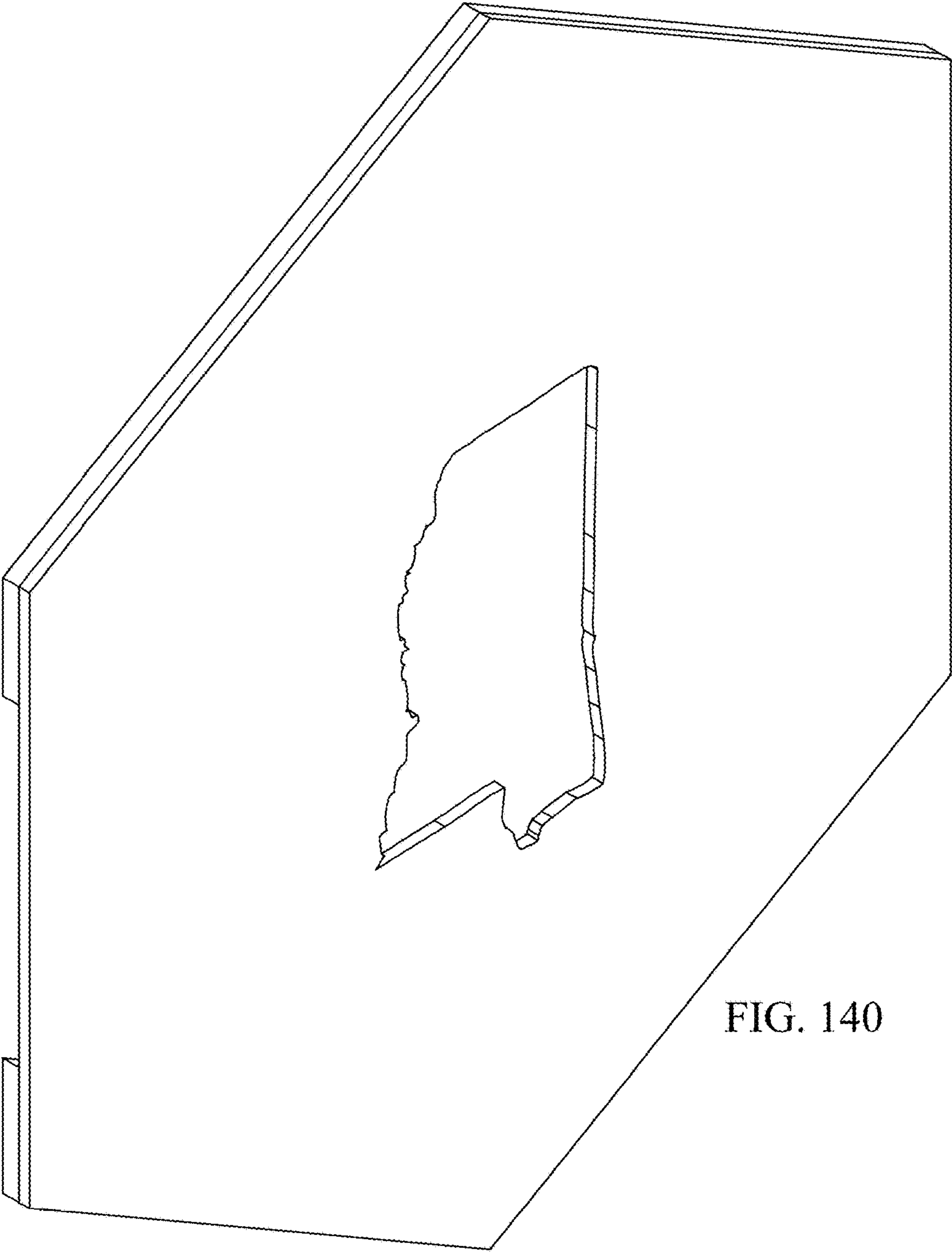

FIG. 140

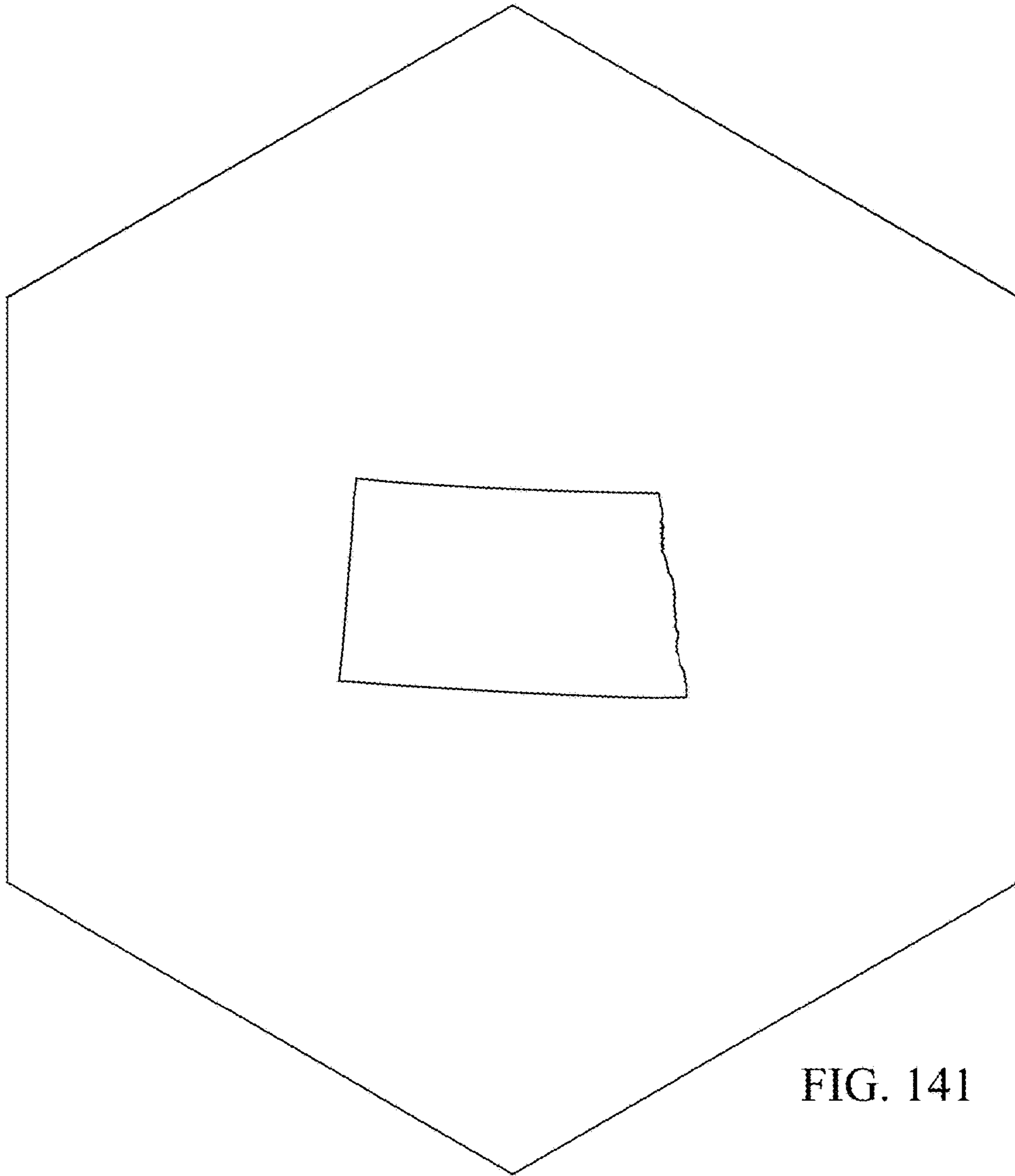

FIG. 141

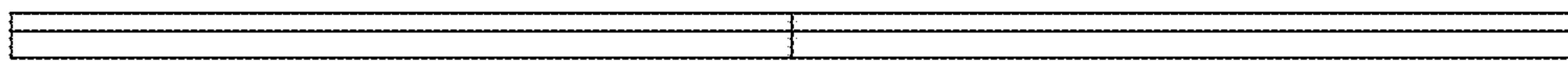

FIG. 142

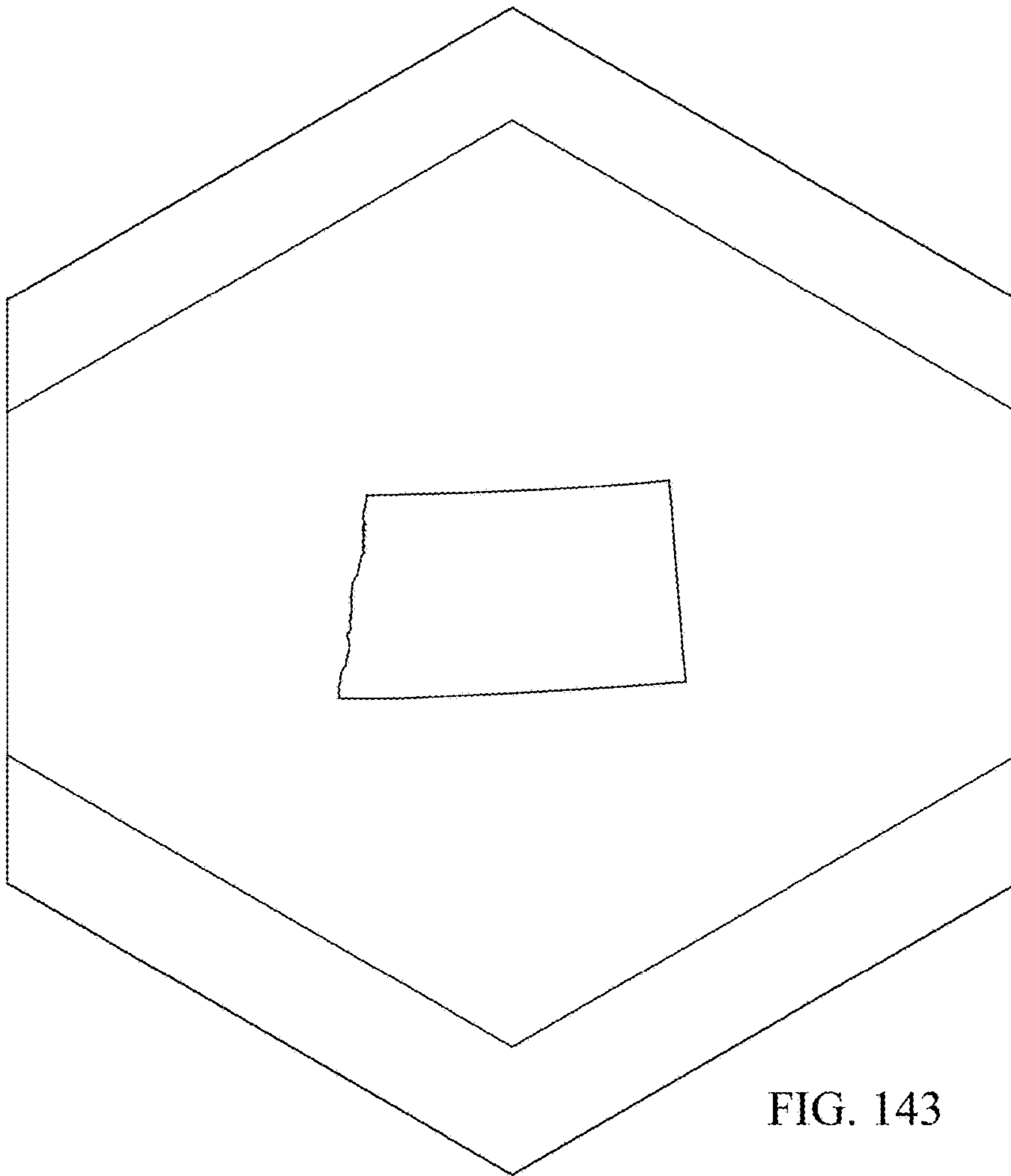

FIG. 143

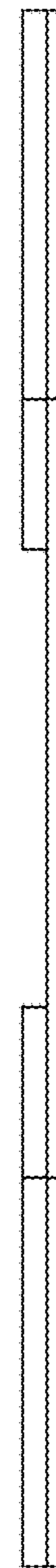

FIG. 144

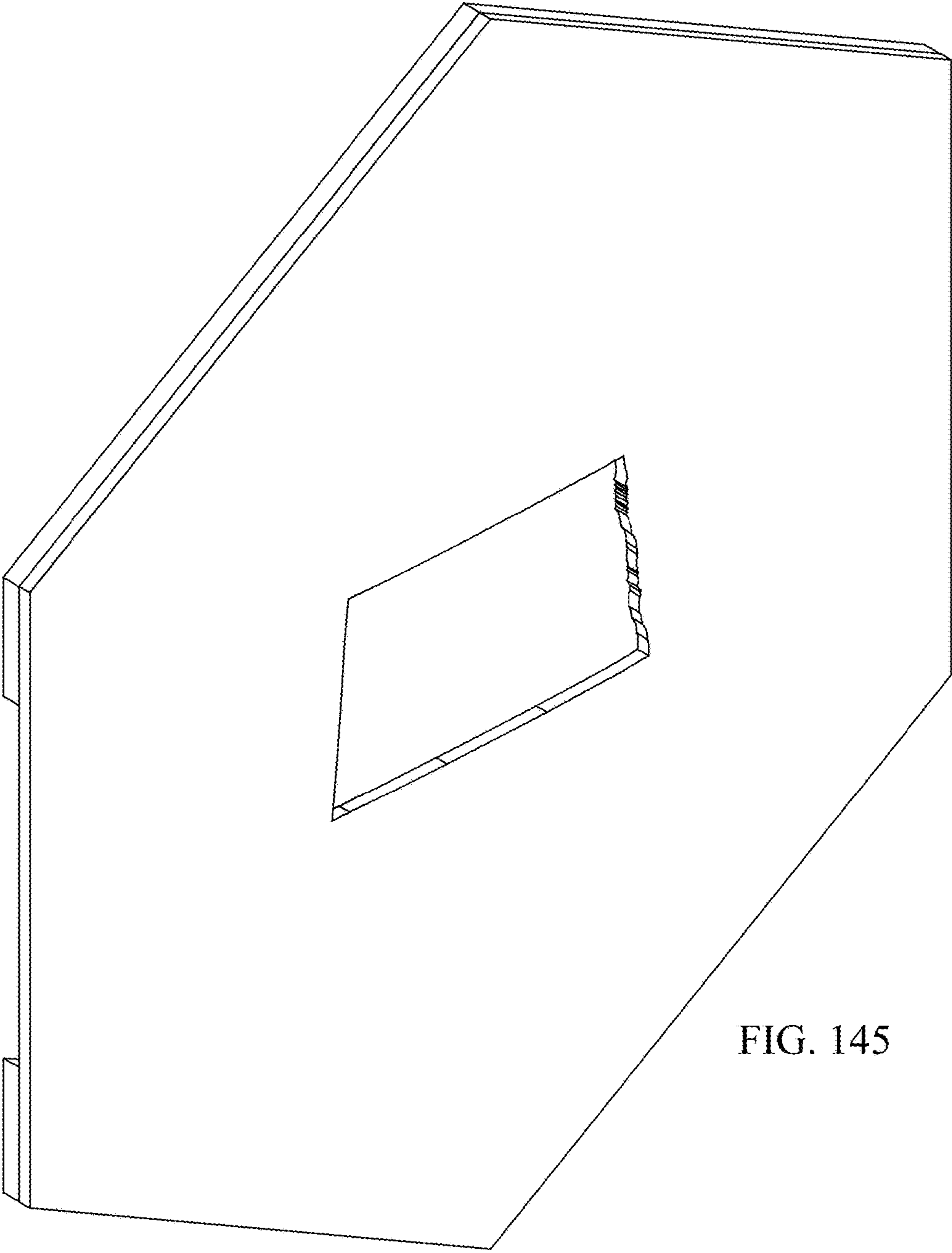

FIG. 145

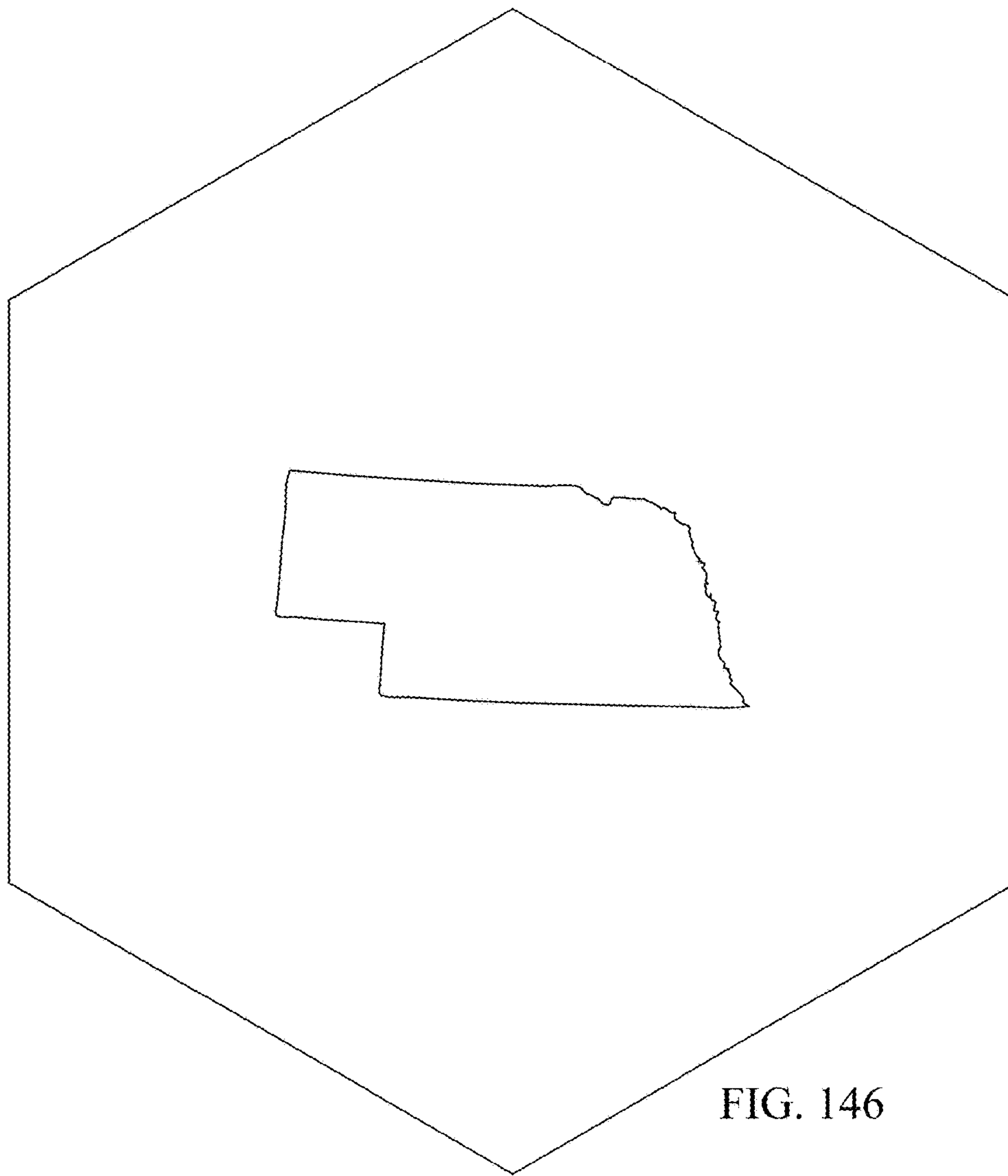

FIG. 146

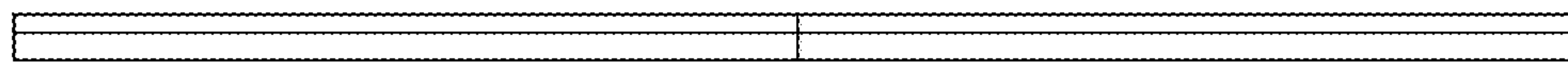

FIG. 147

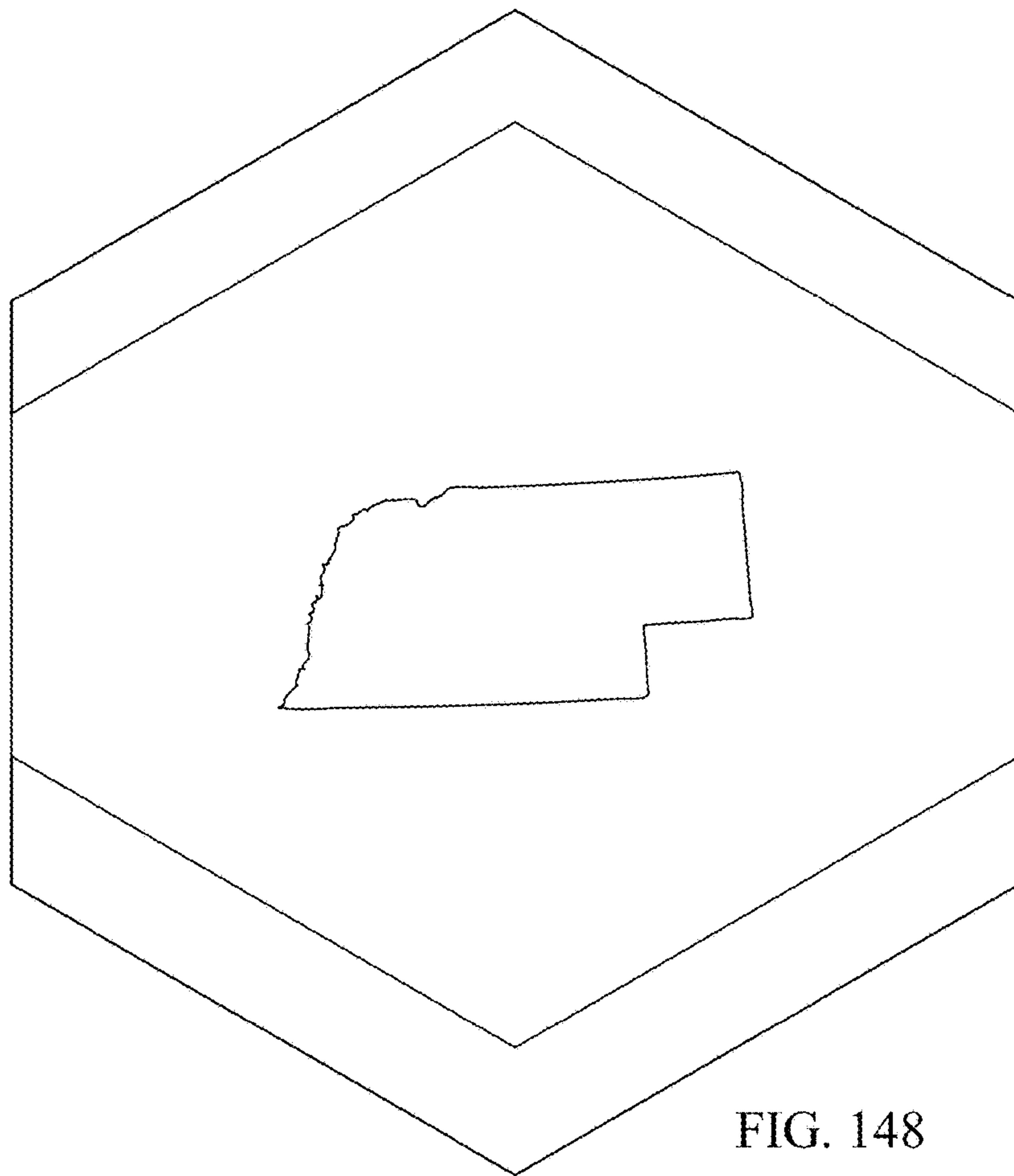

FIG. 148



FIG. 149

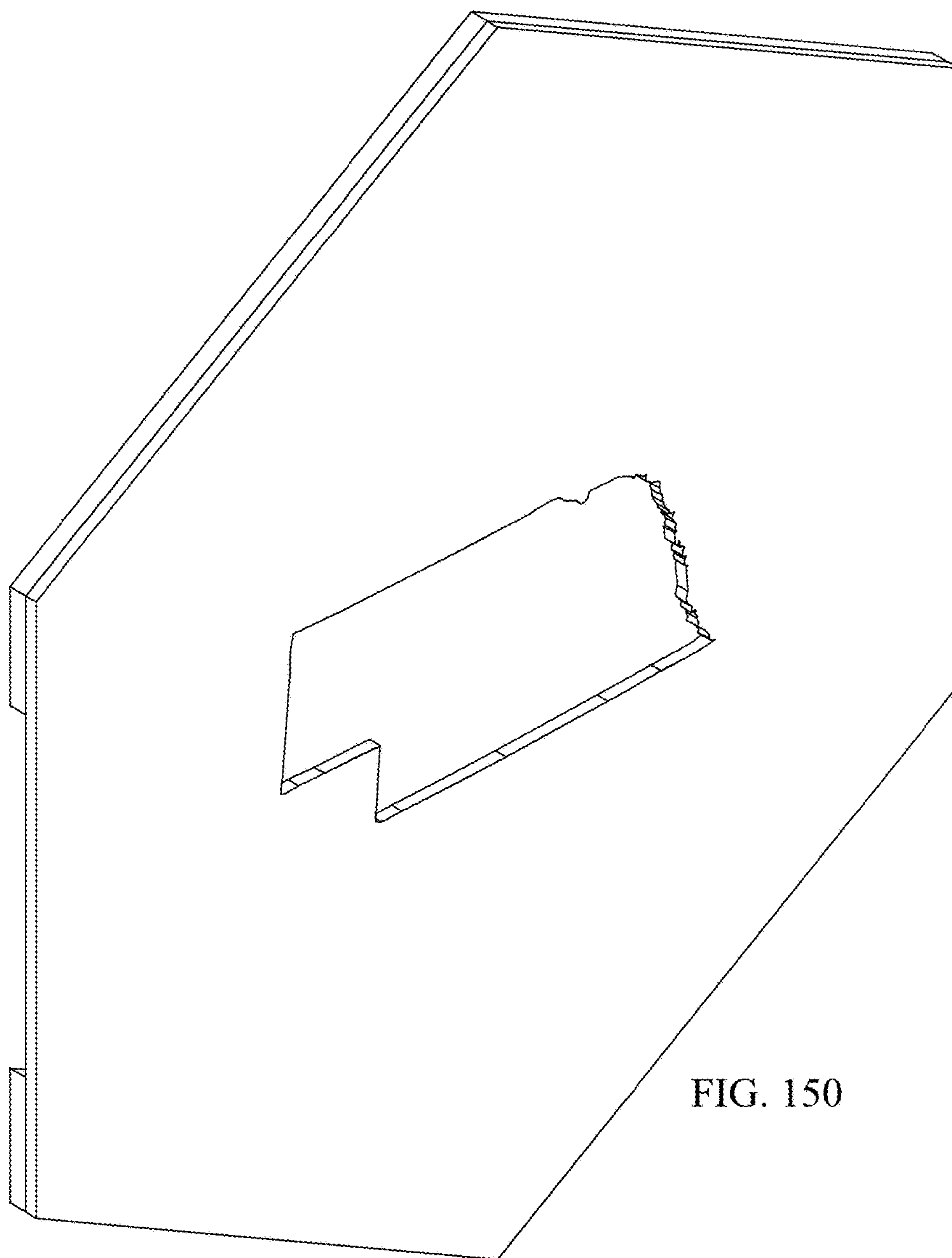

FIG. 150

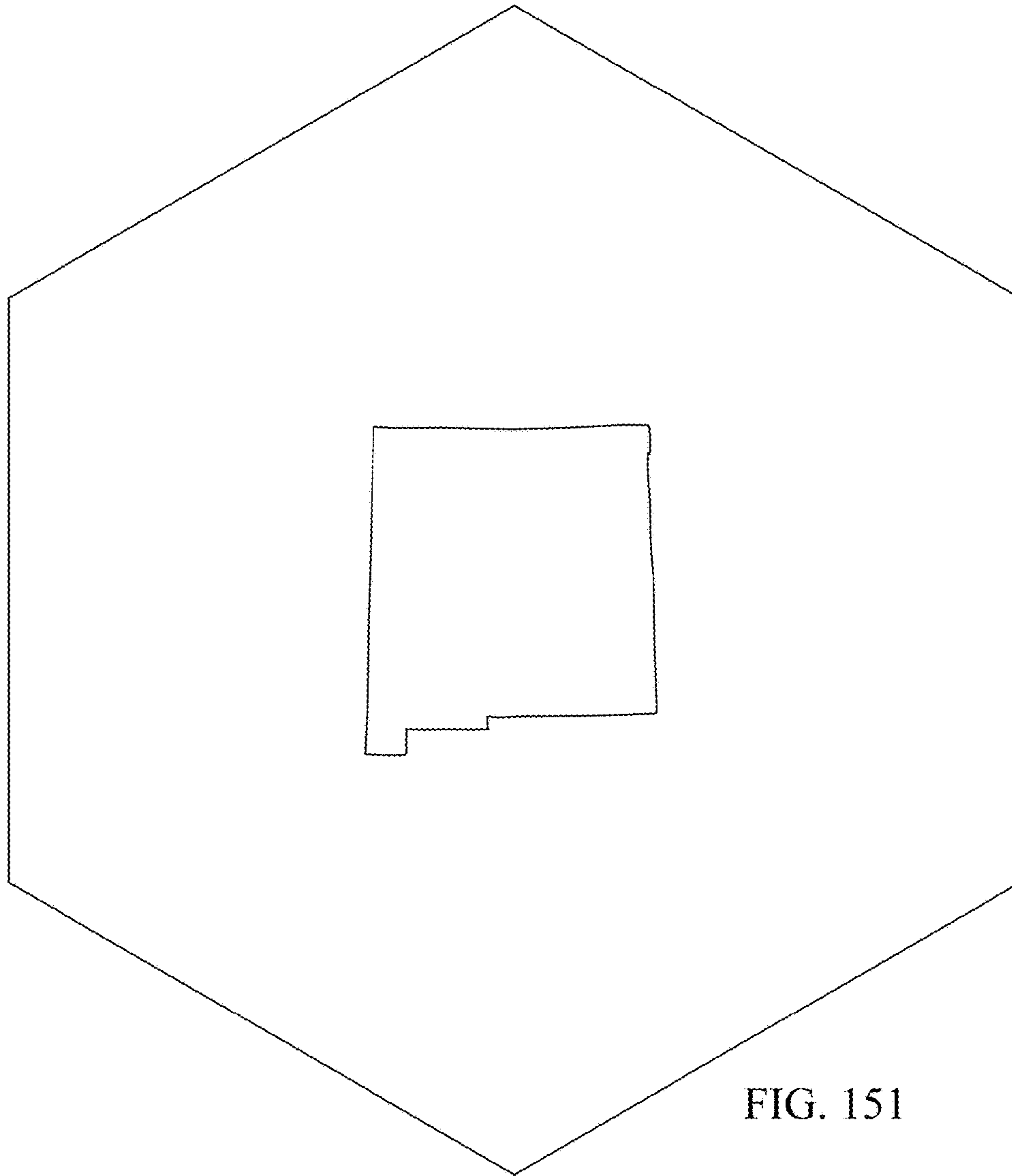

FIG. 151

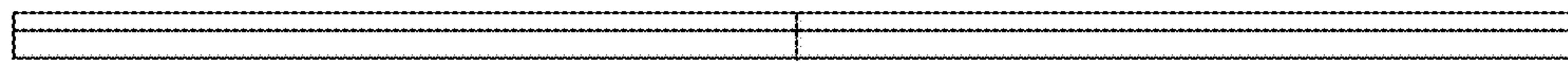

FIG. 152

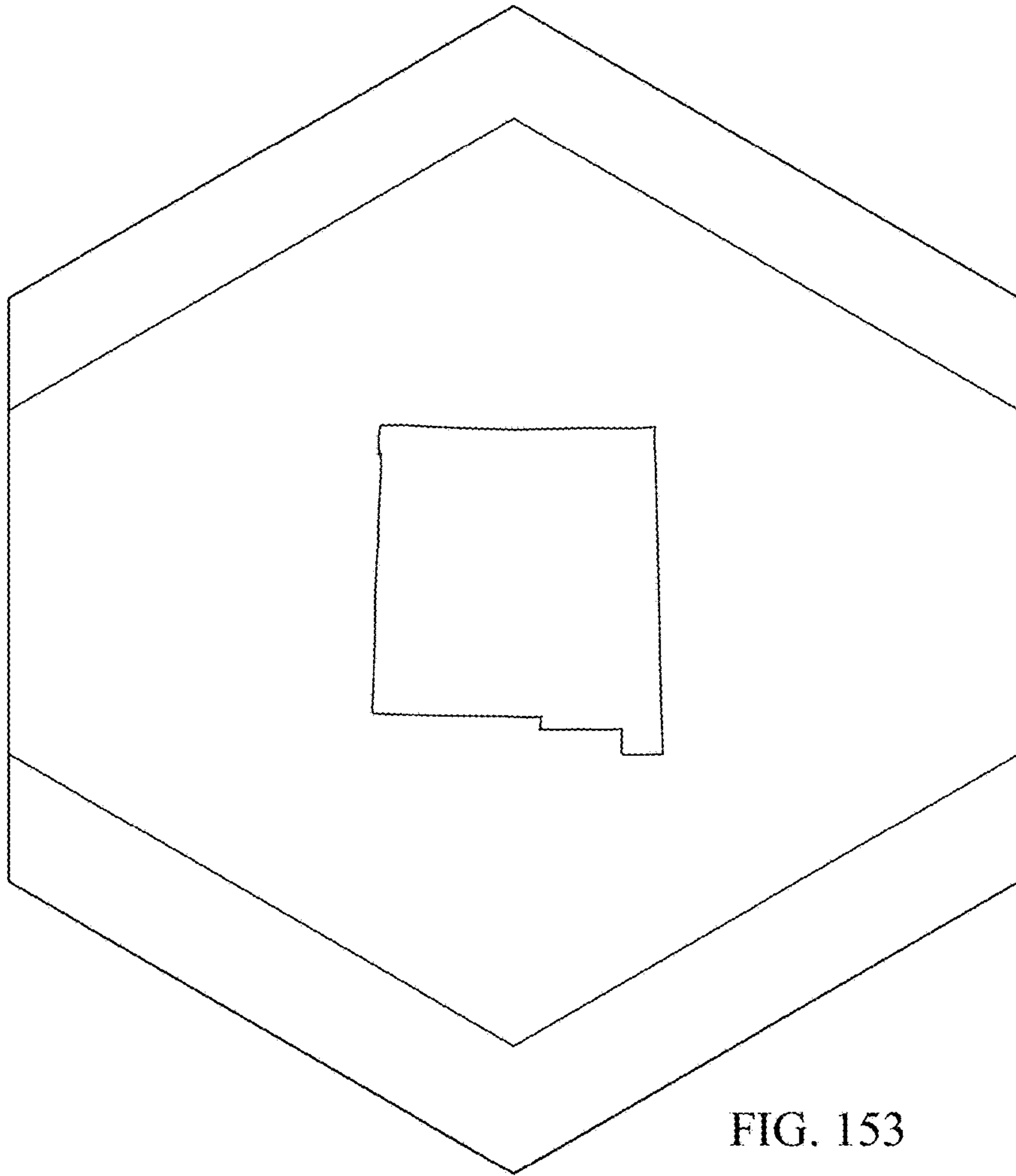

FIG. 153



FIG. 154

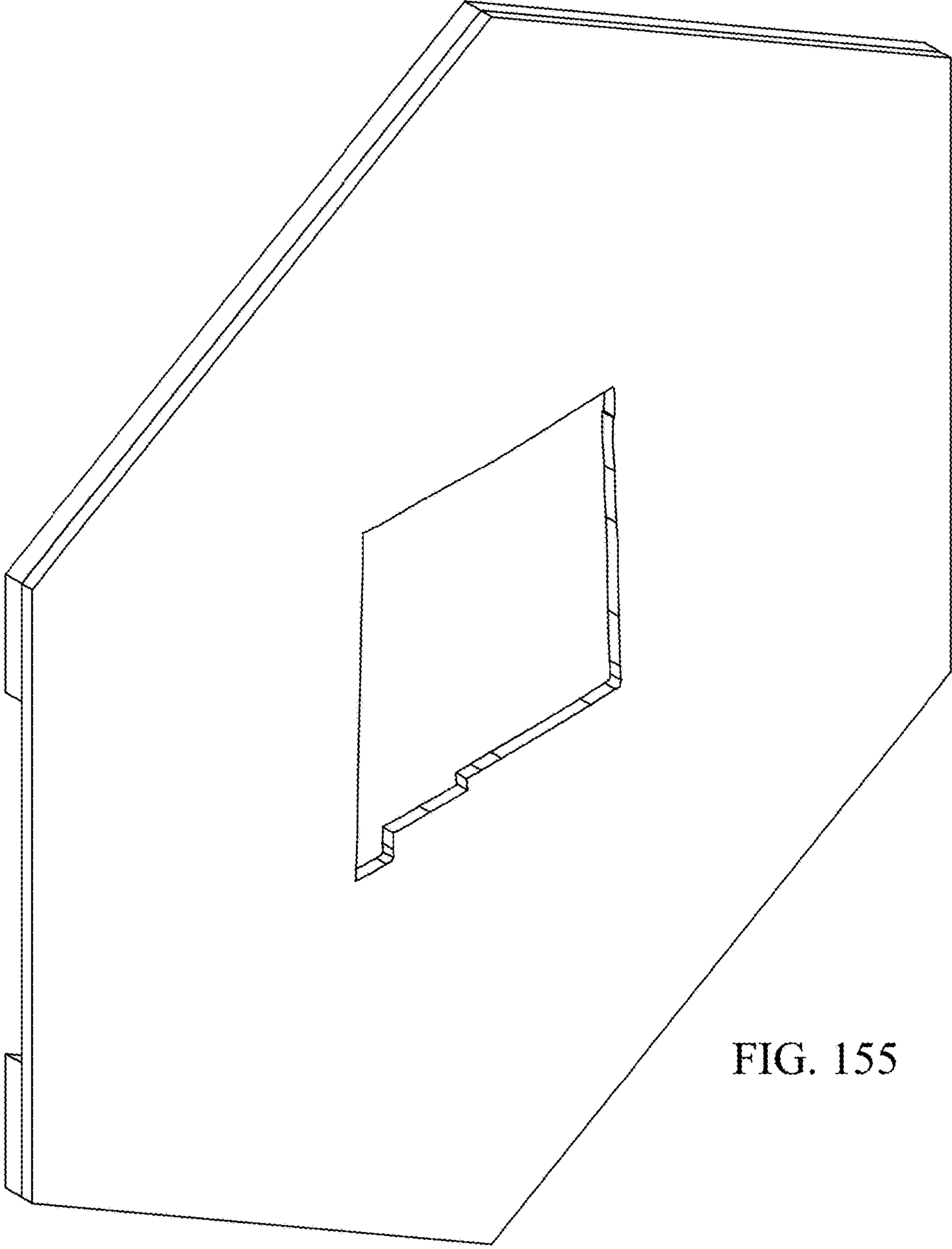

FIG. 155

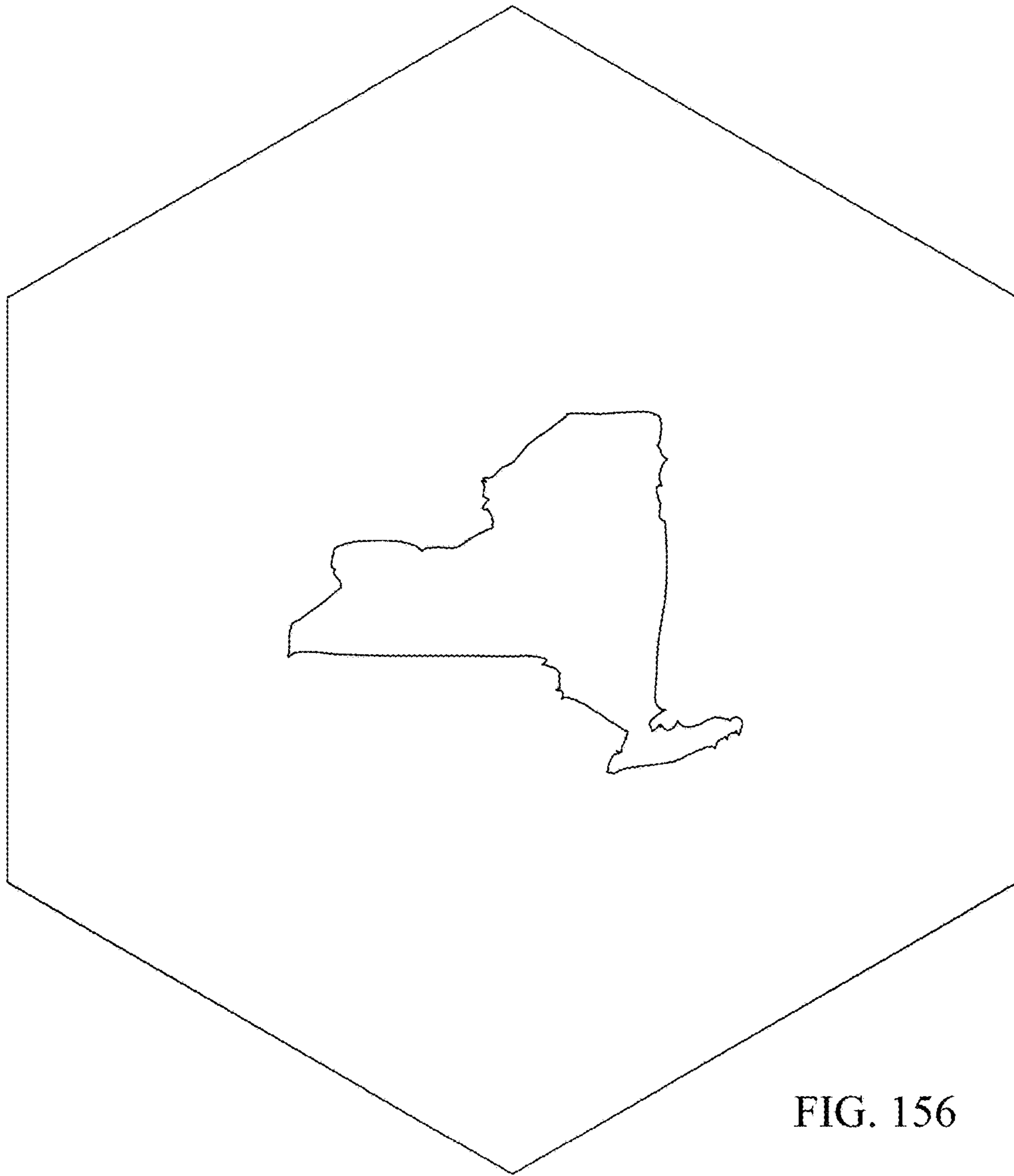

FIG. 156

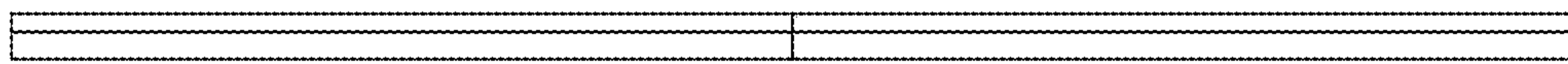

FIG. 157

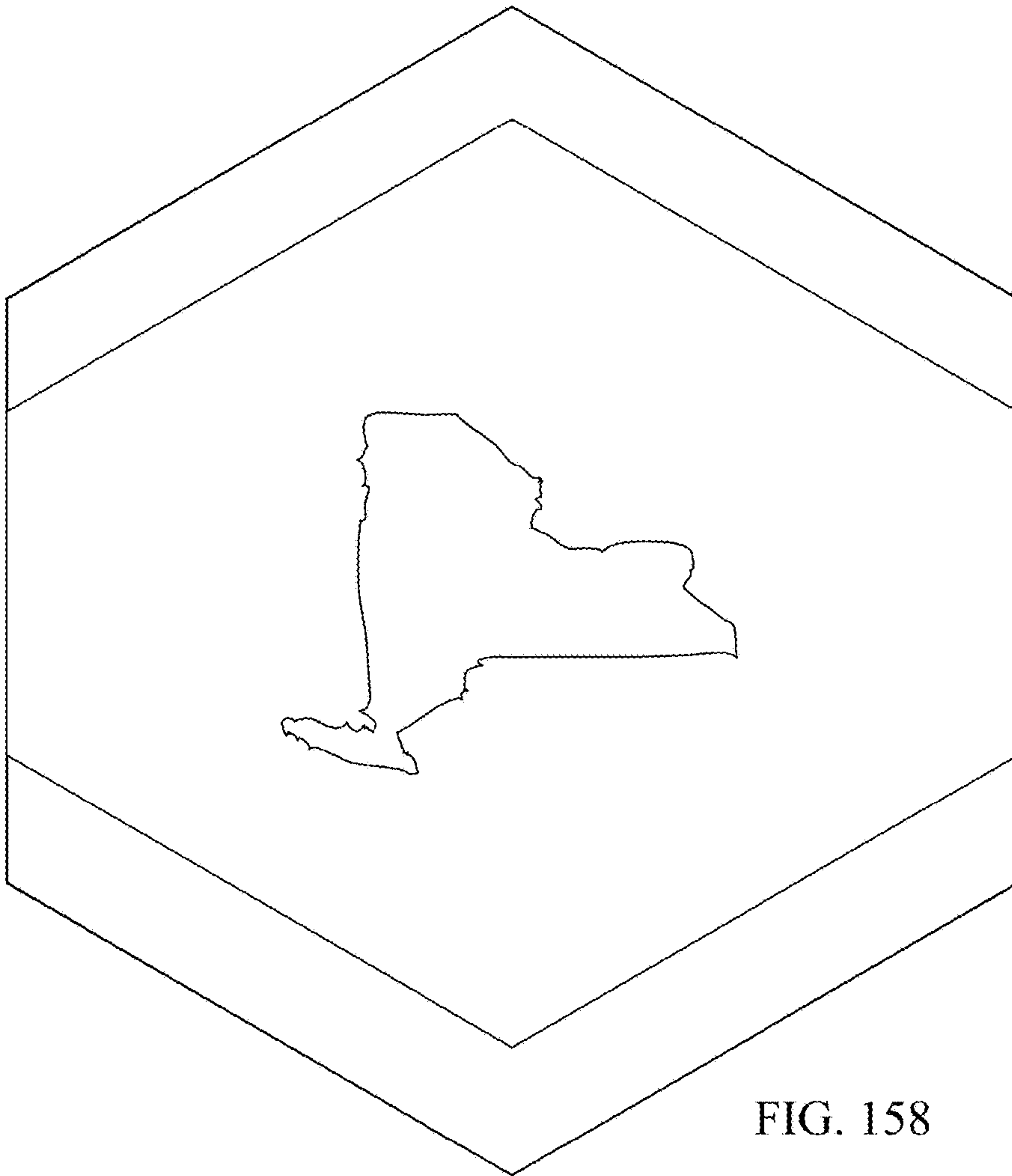

FIG. 158



FIG. 159

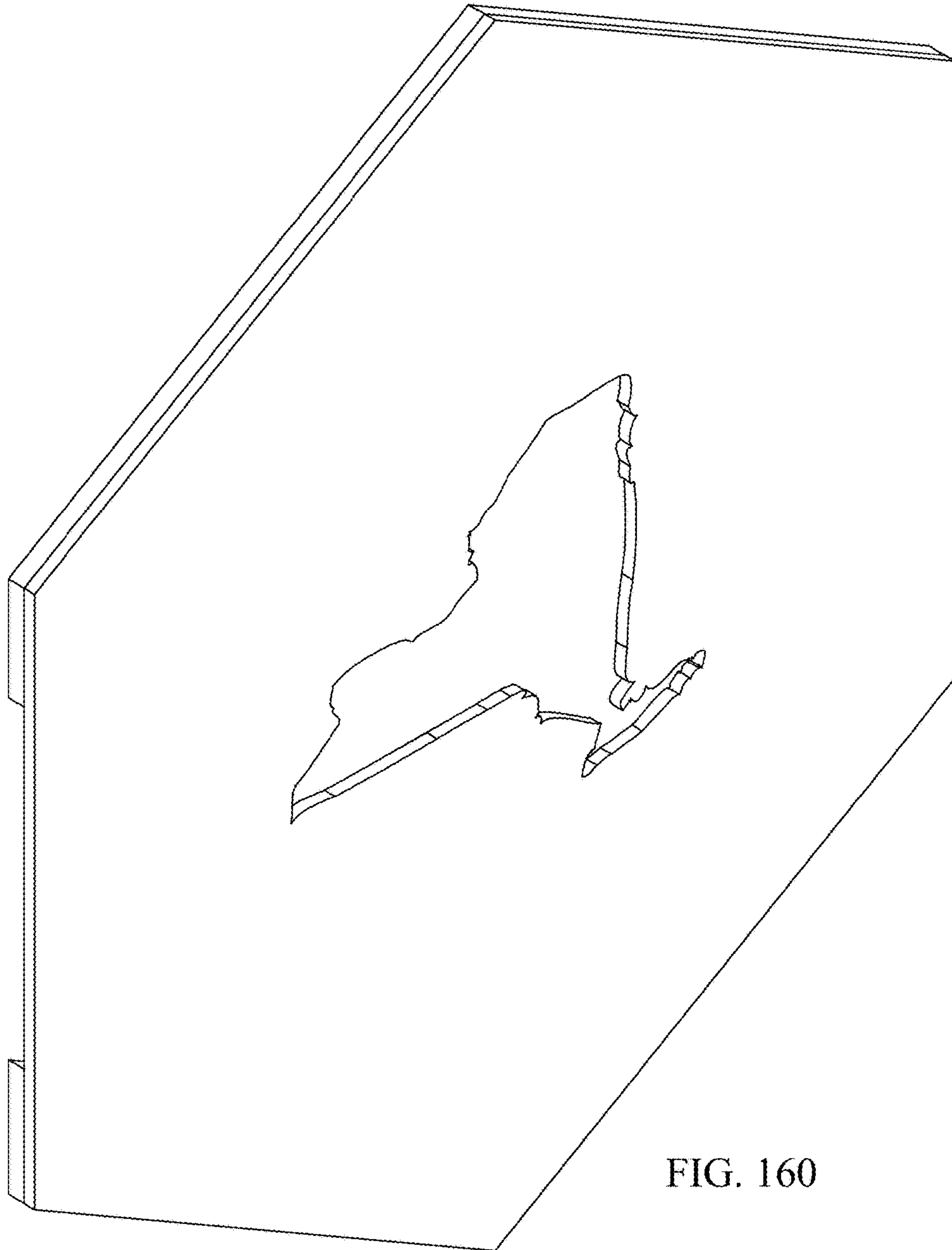

FIG. 160

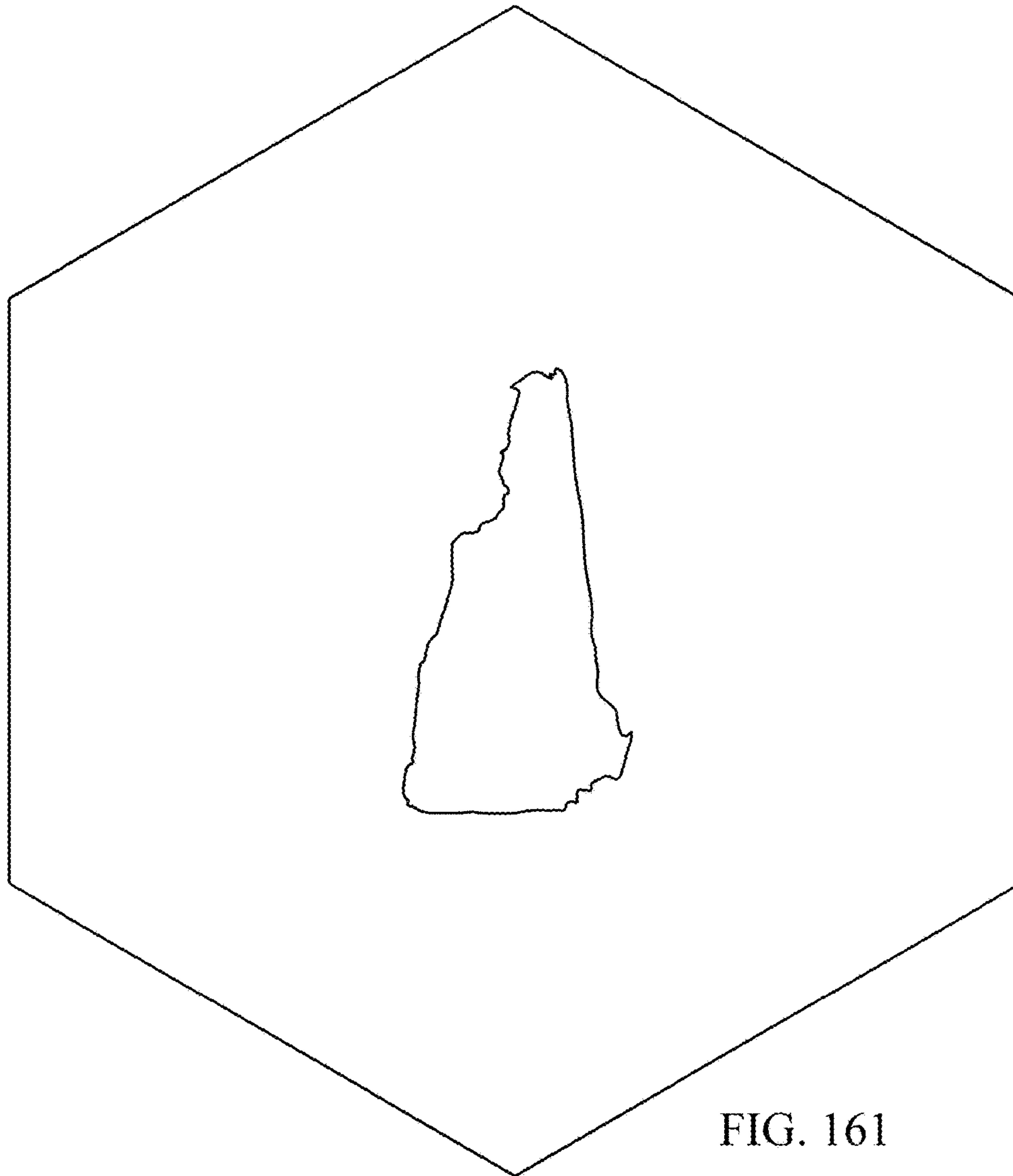

FIG. 161

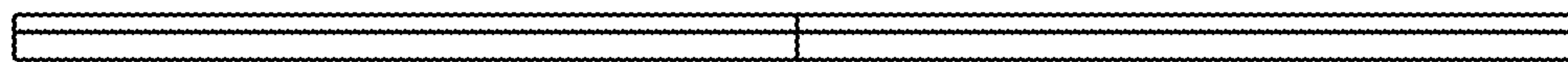

FIG. 162

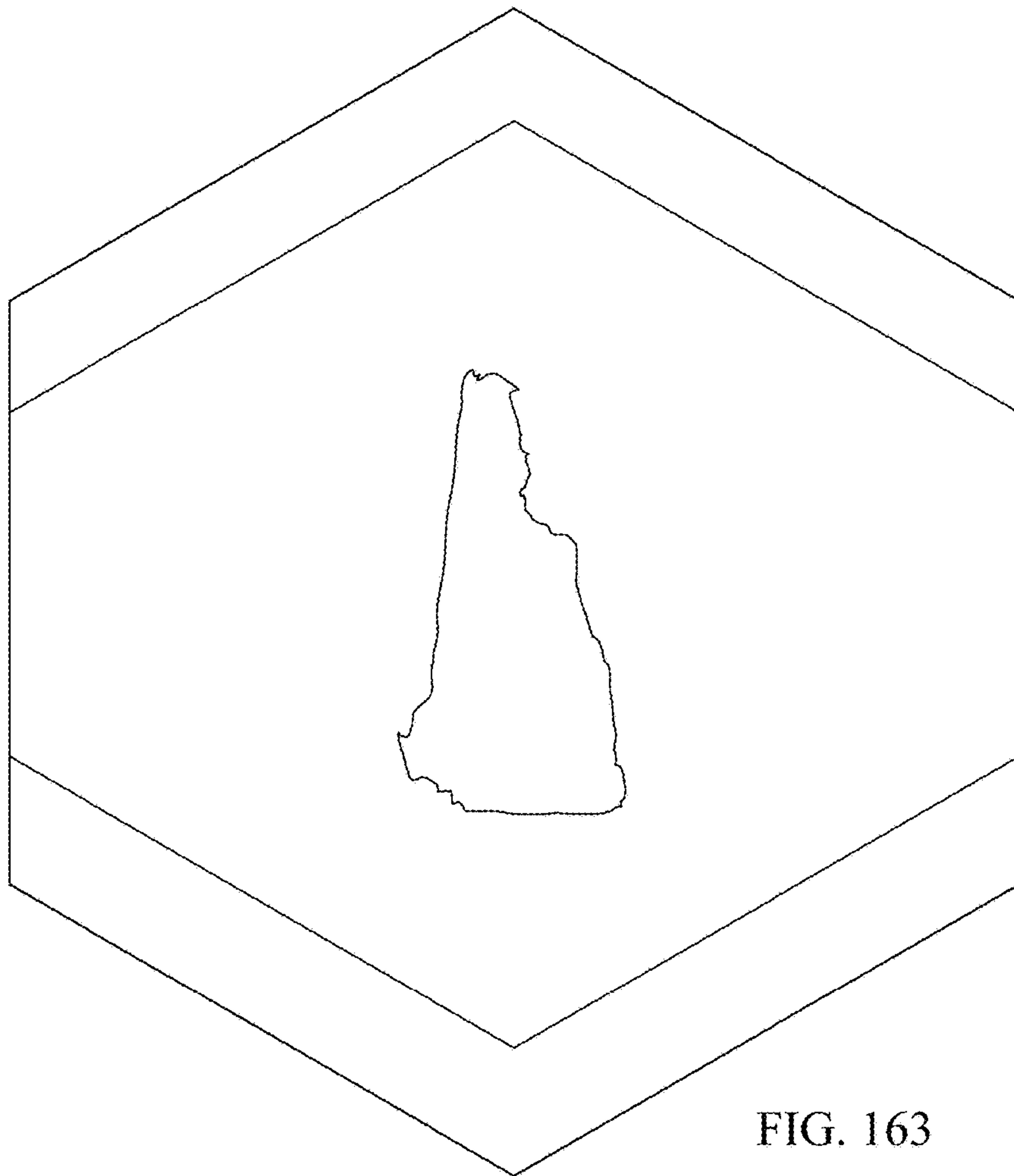

FIG. 163



FIG. 164

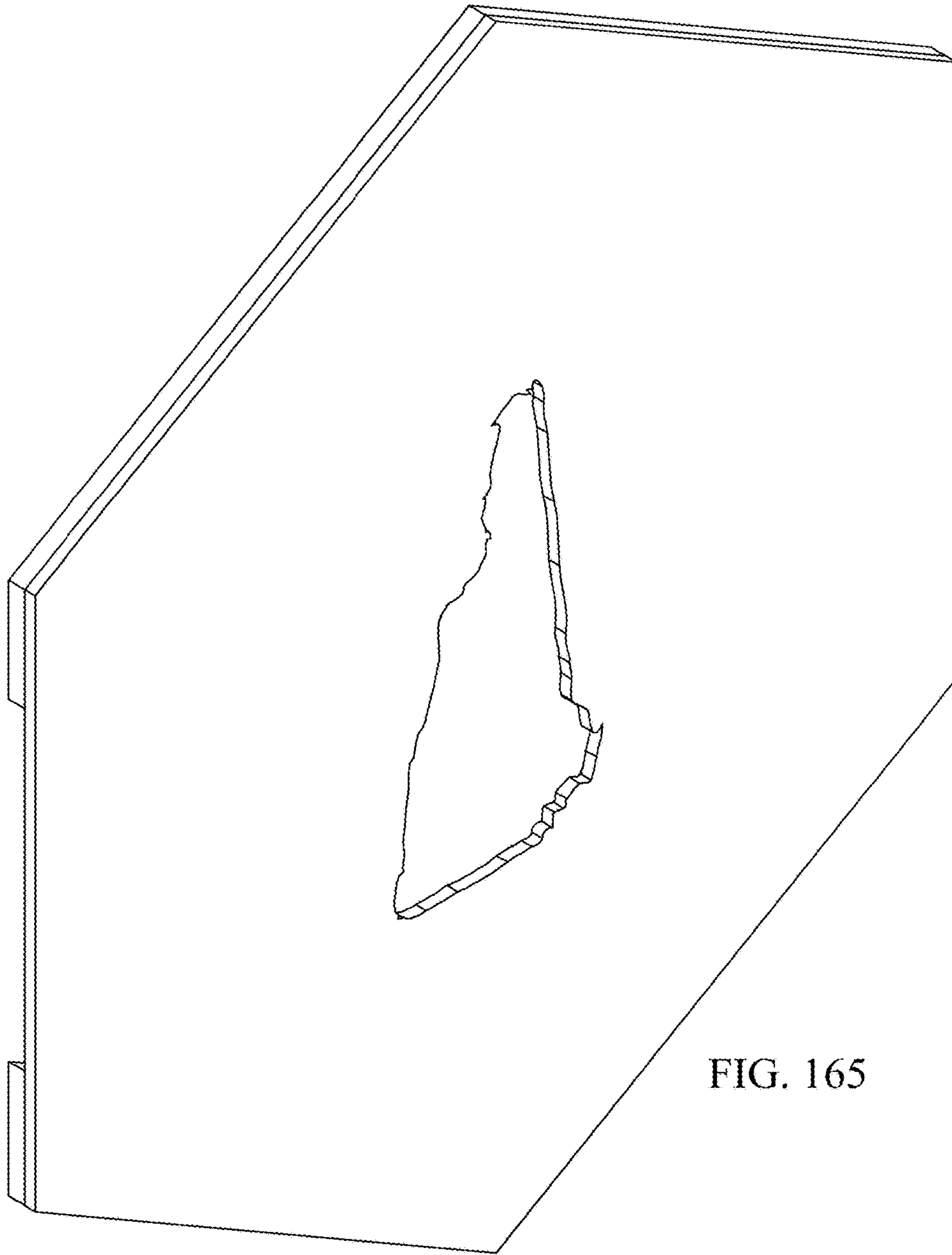

FIG. 165

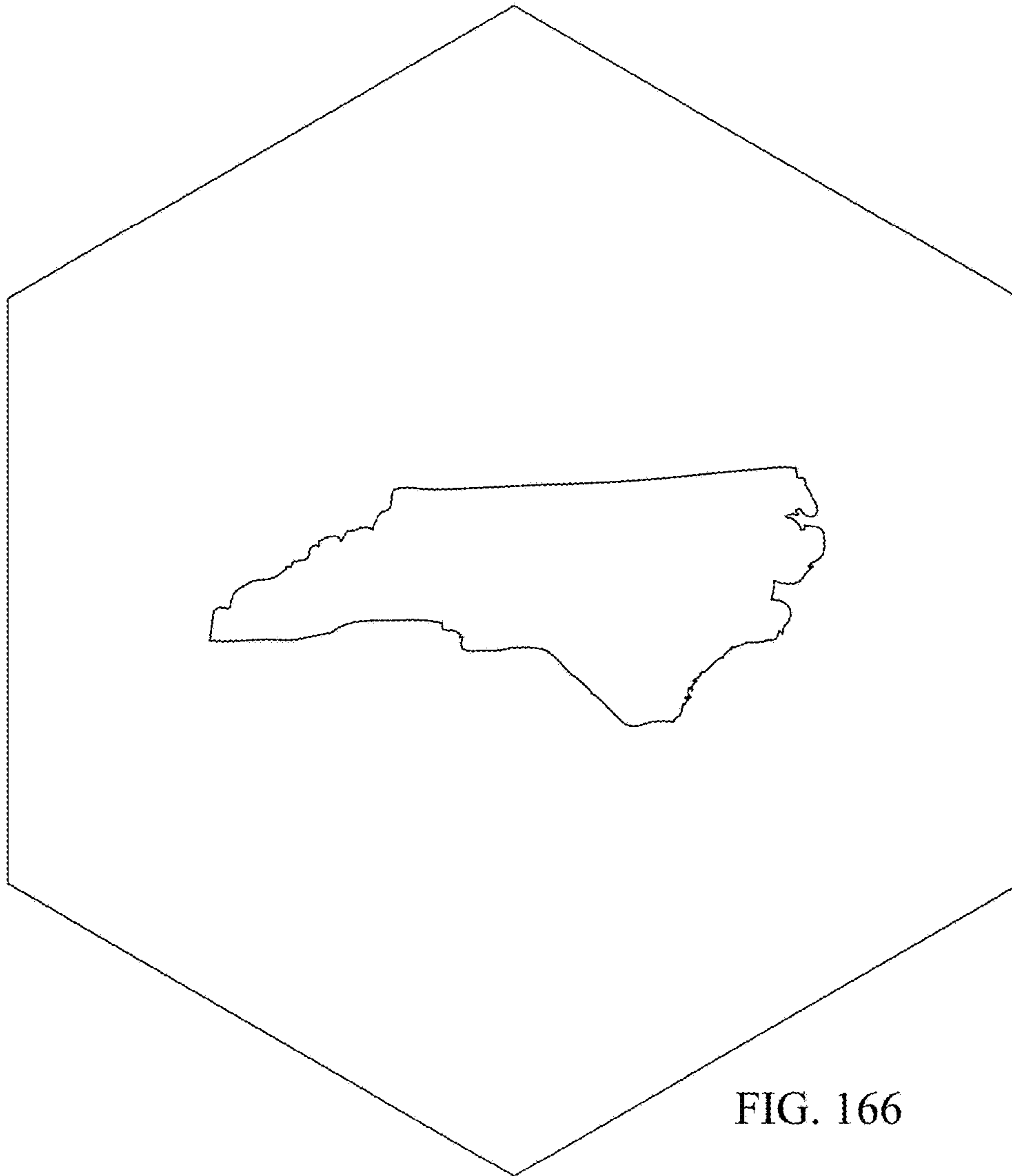

FIG. 166

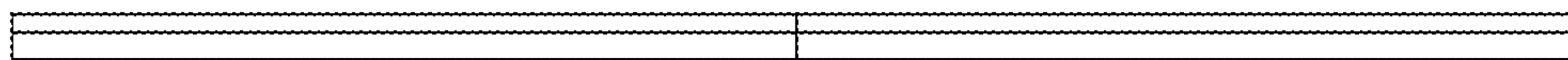

FIG. 167

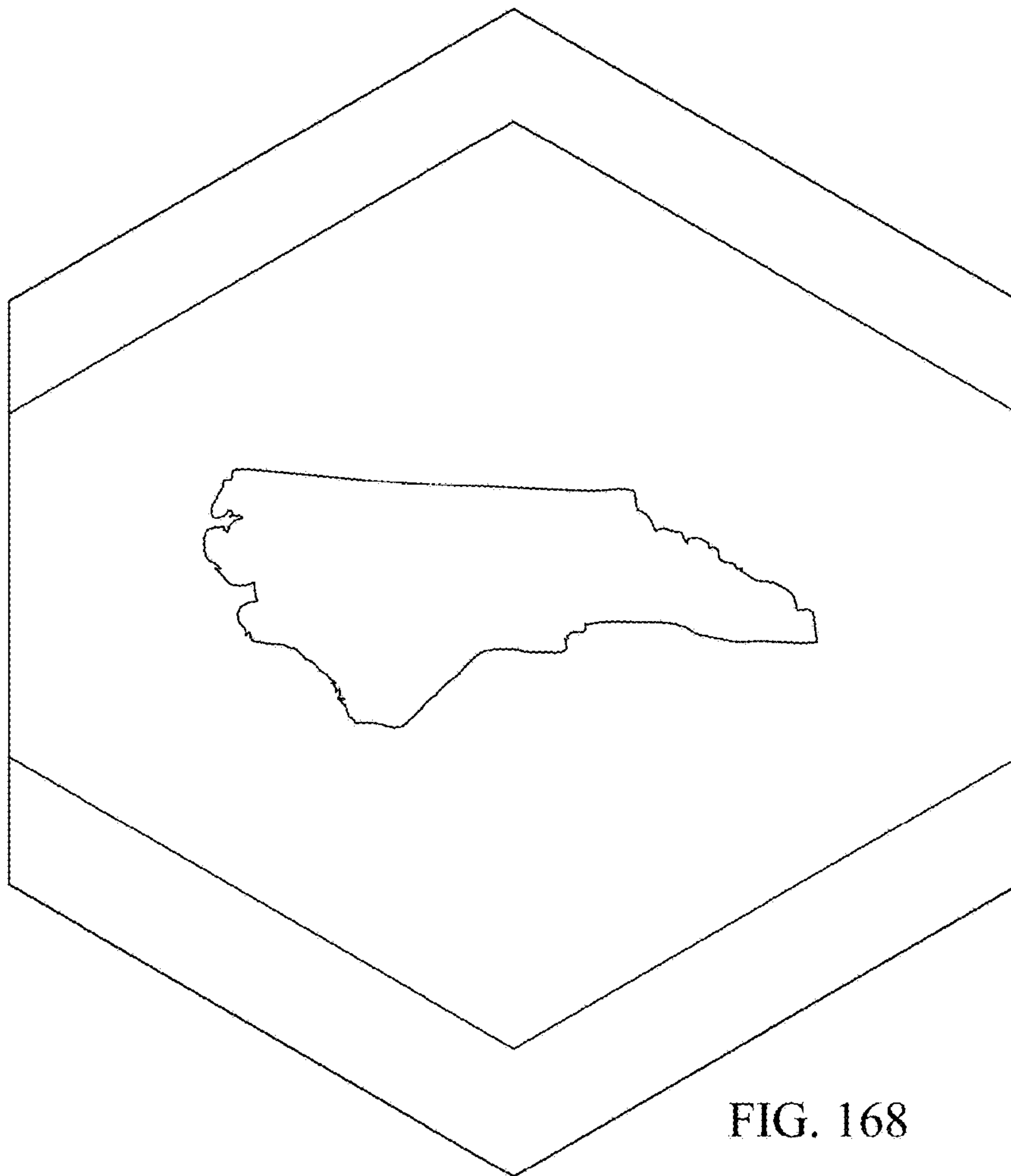

FIG. 168



FIG. 169

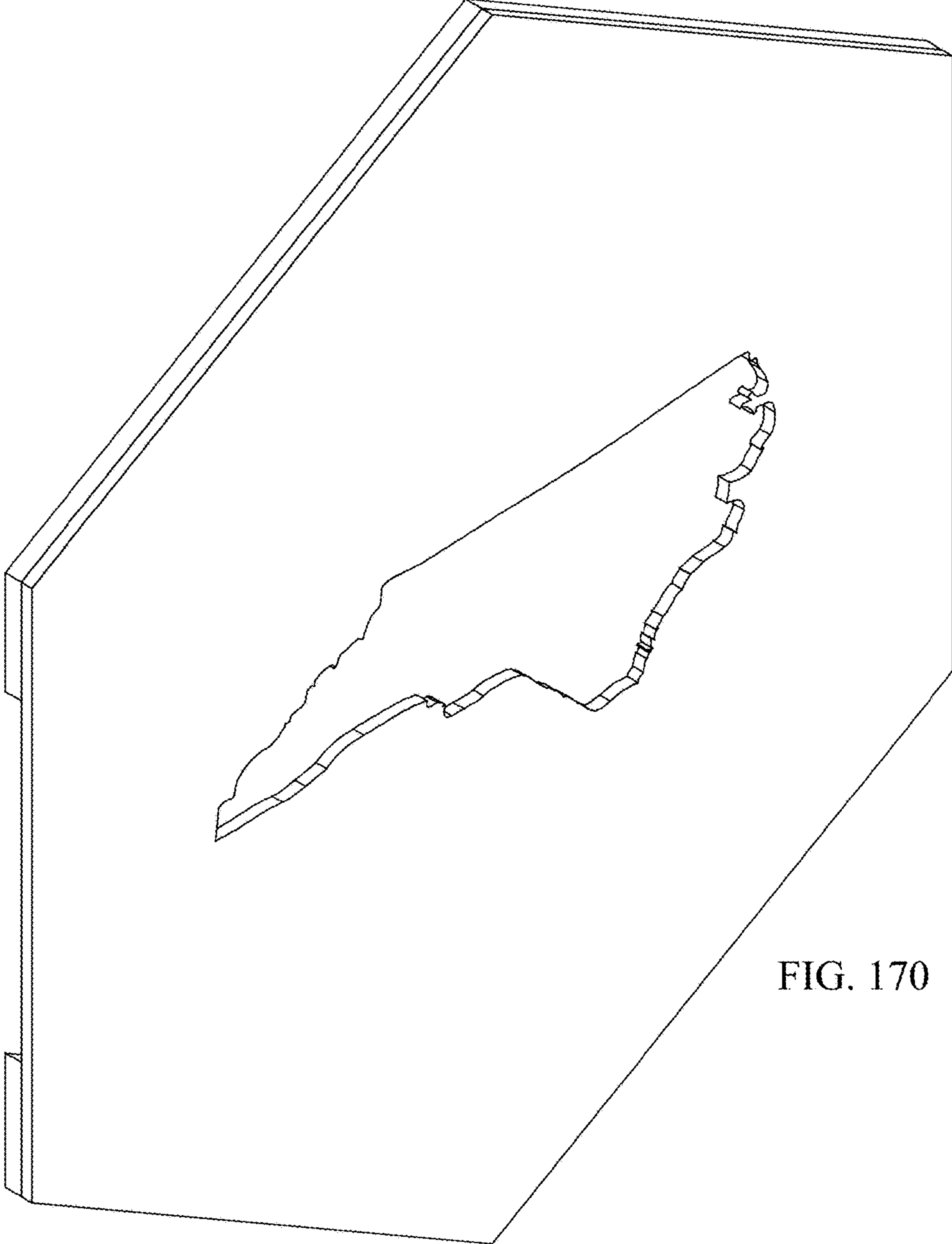

FIG. 170

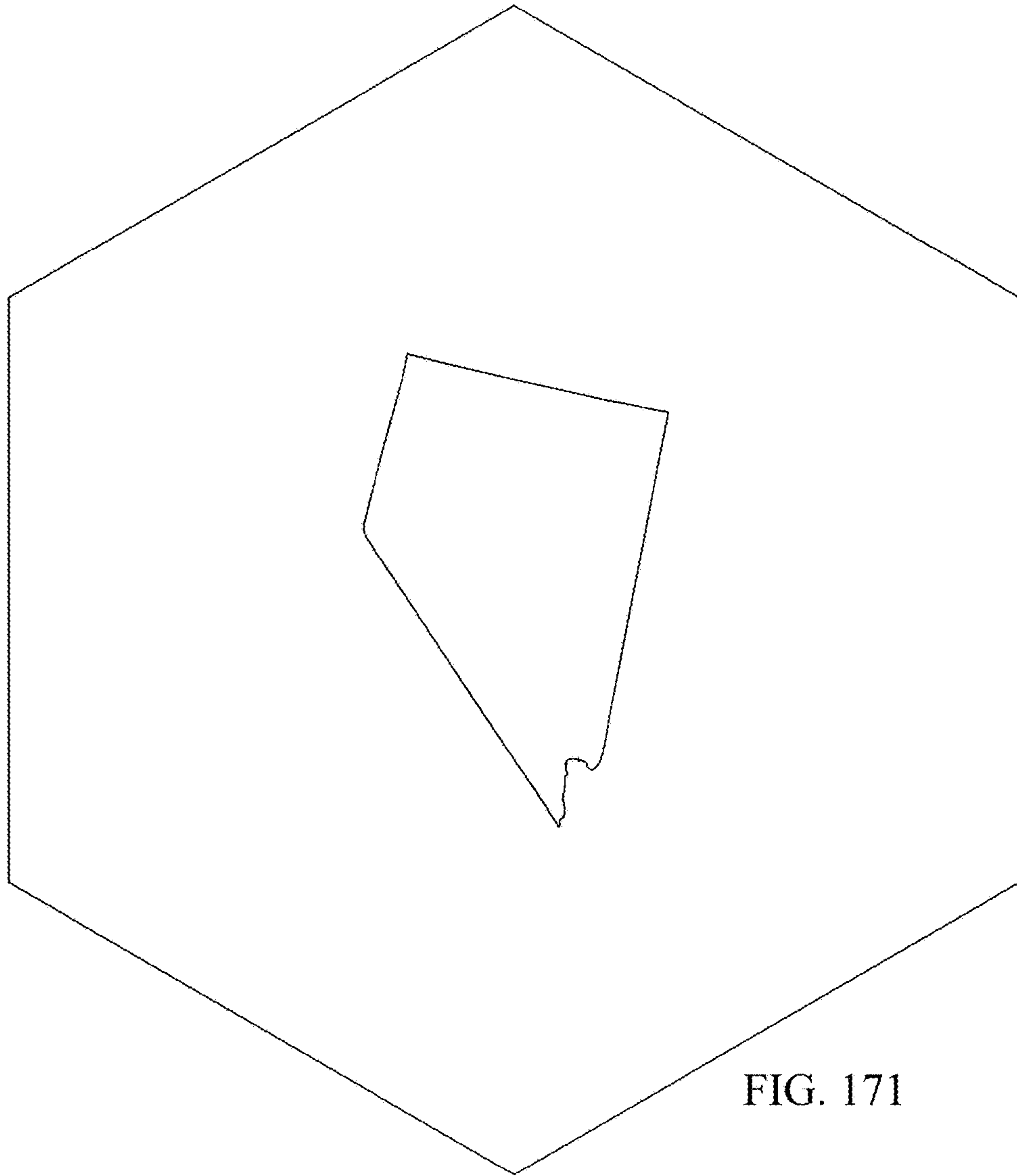

FIG. 171

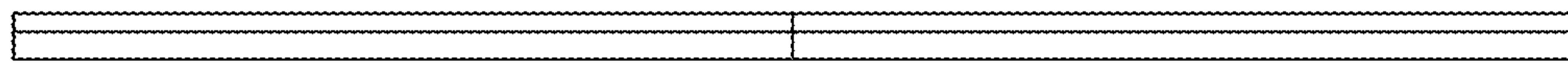

FIG. 172

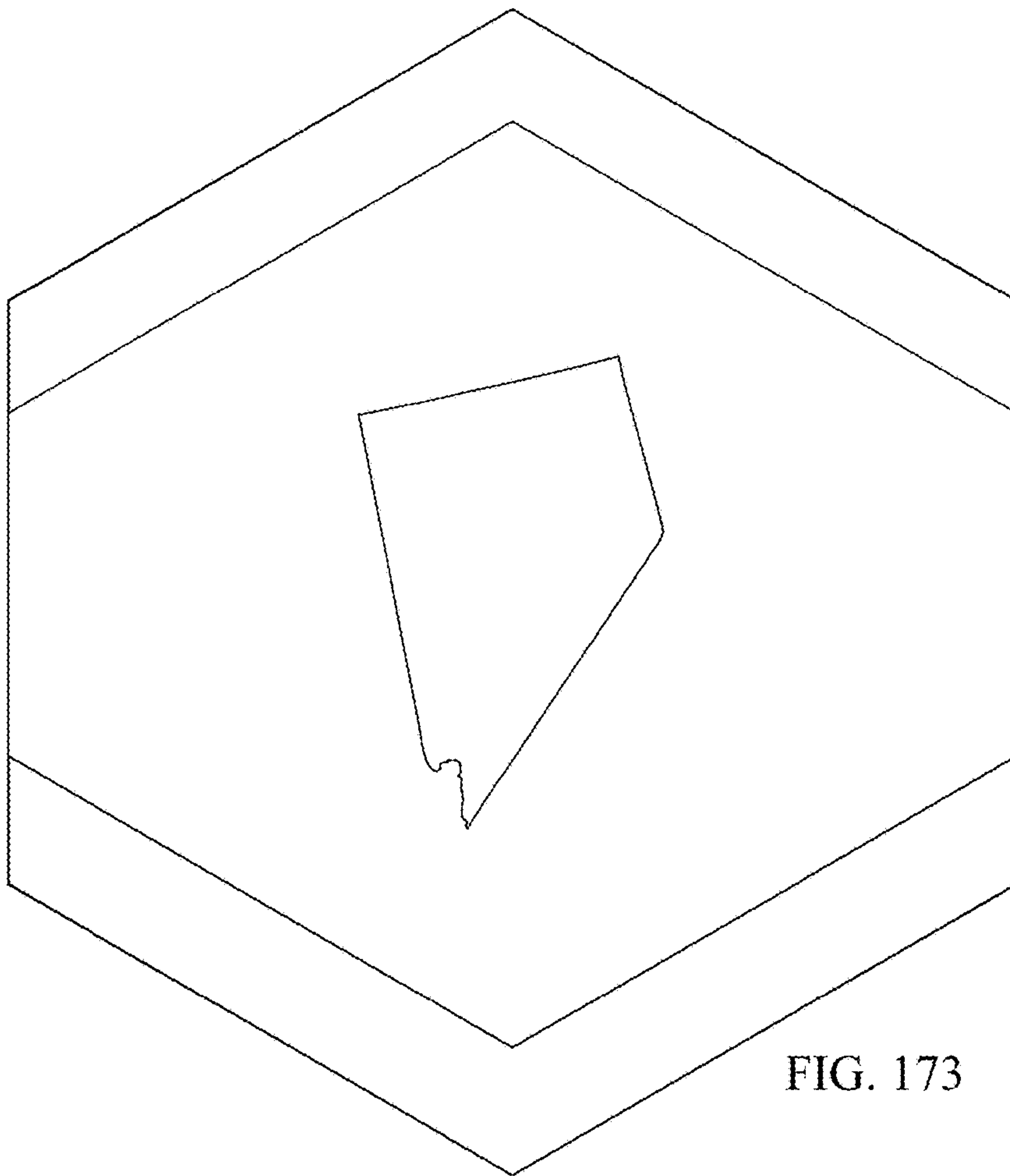

FIG. 173

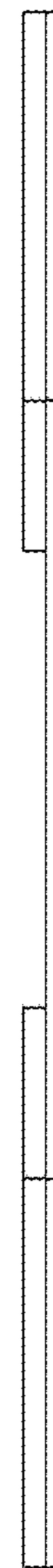
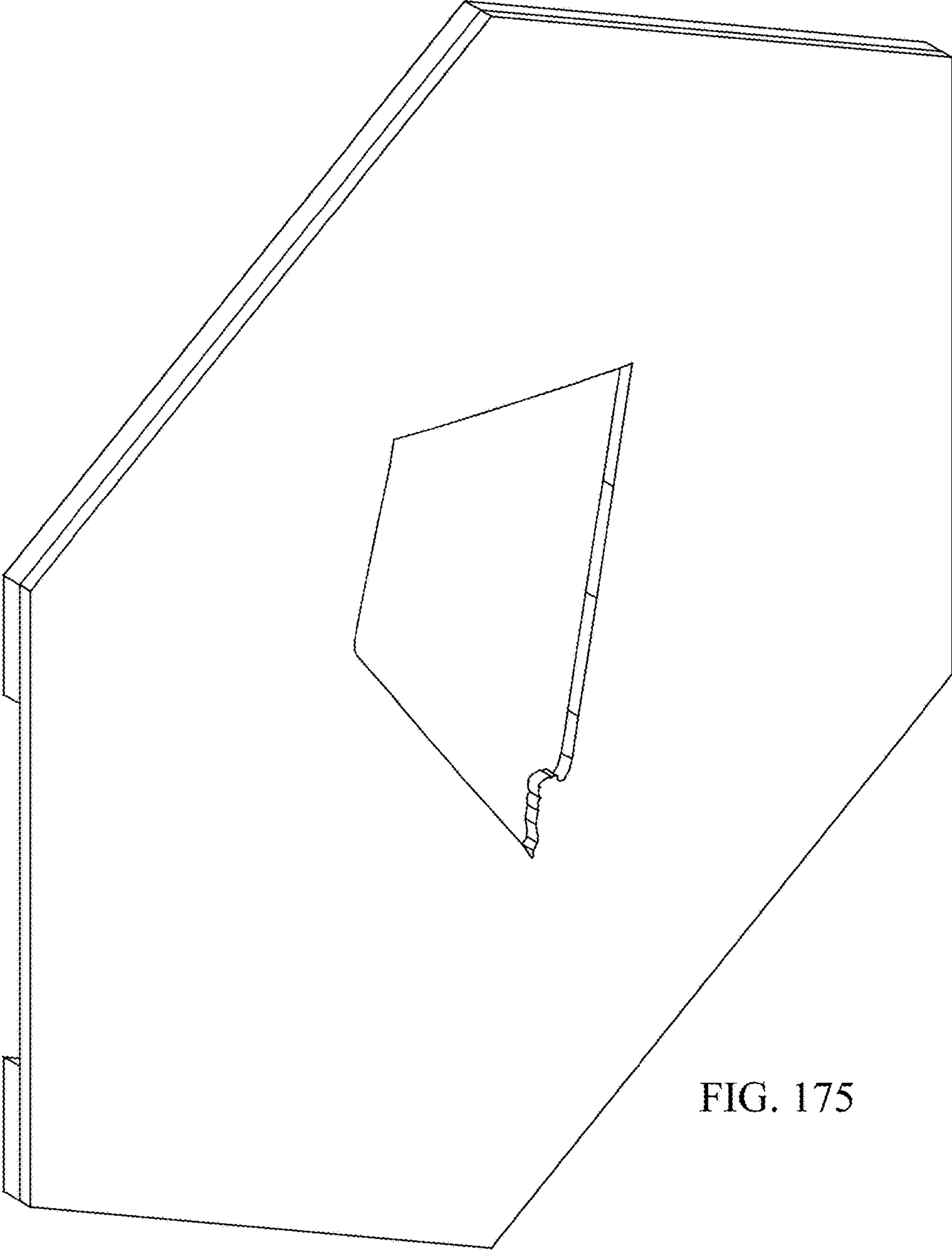

FIG. 174



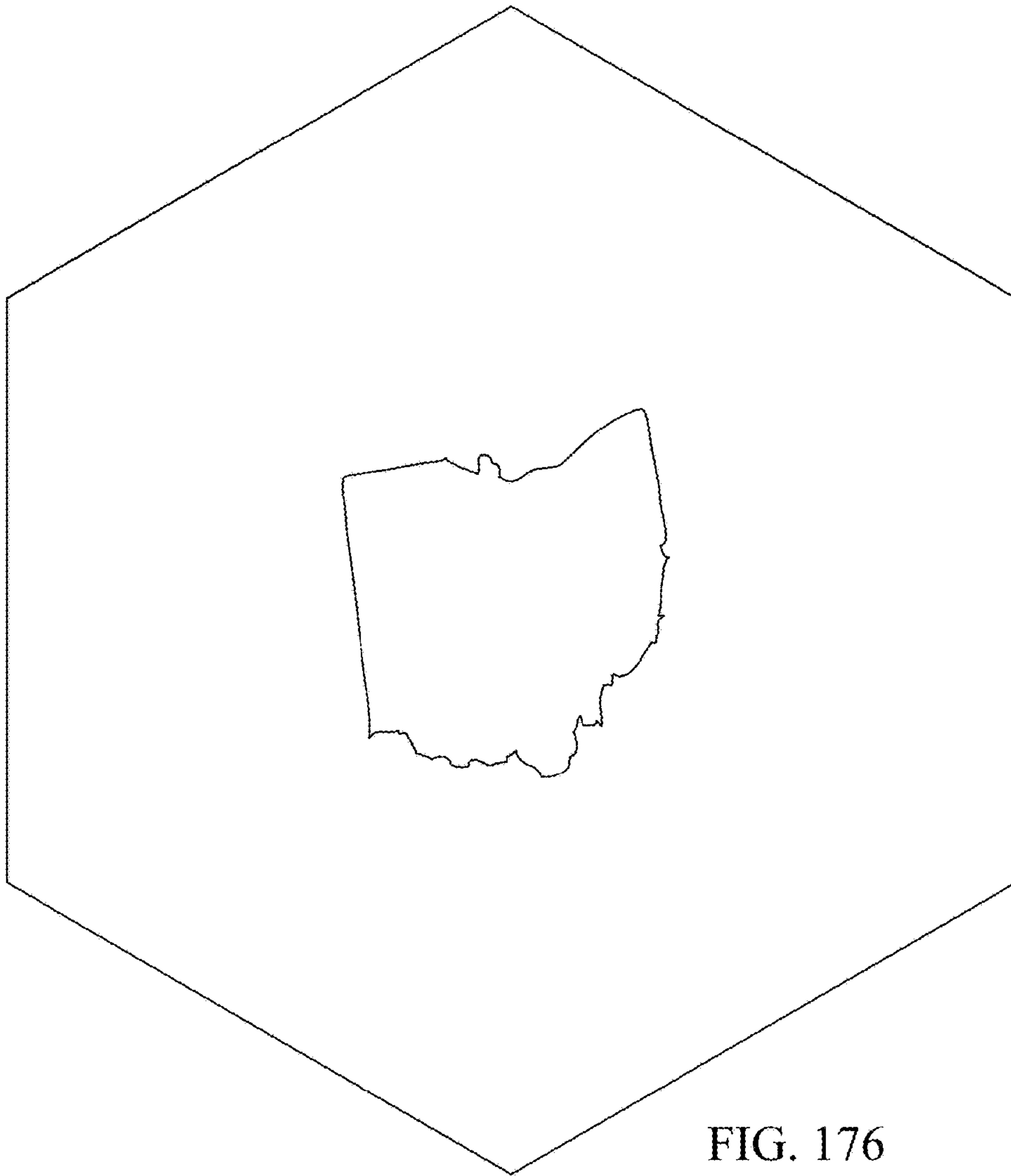

FIG. 176

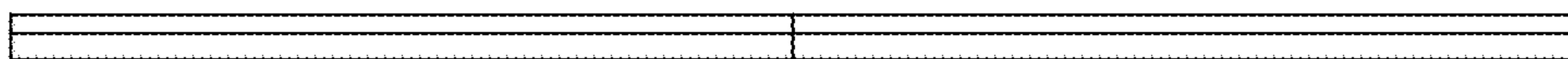

FIG. 177

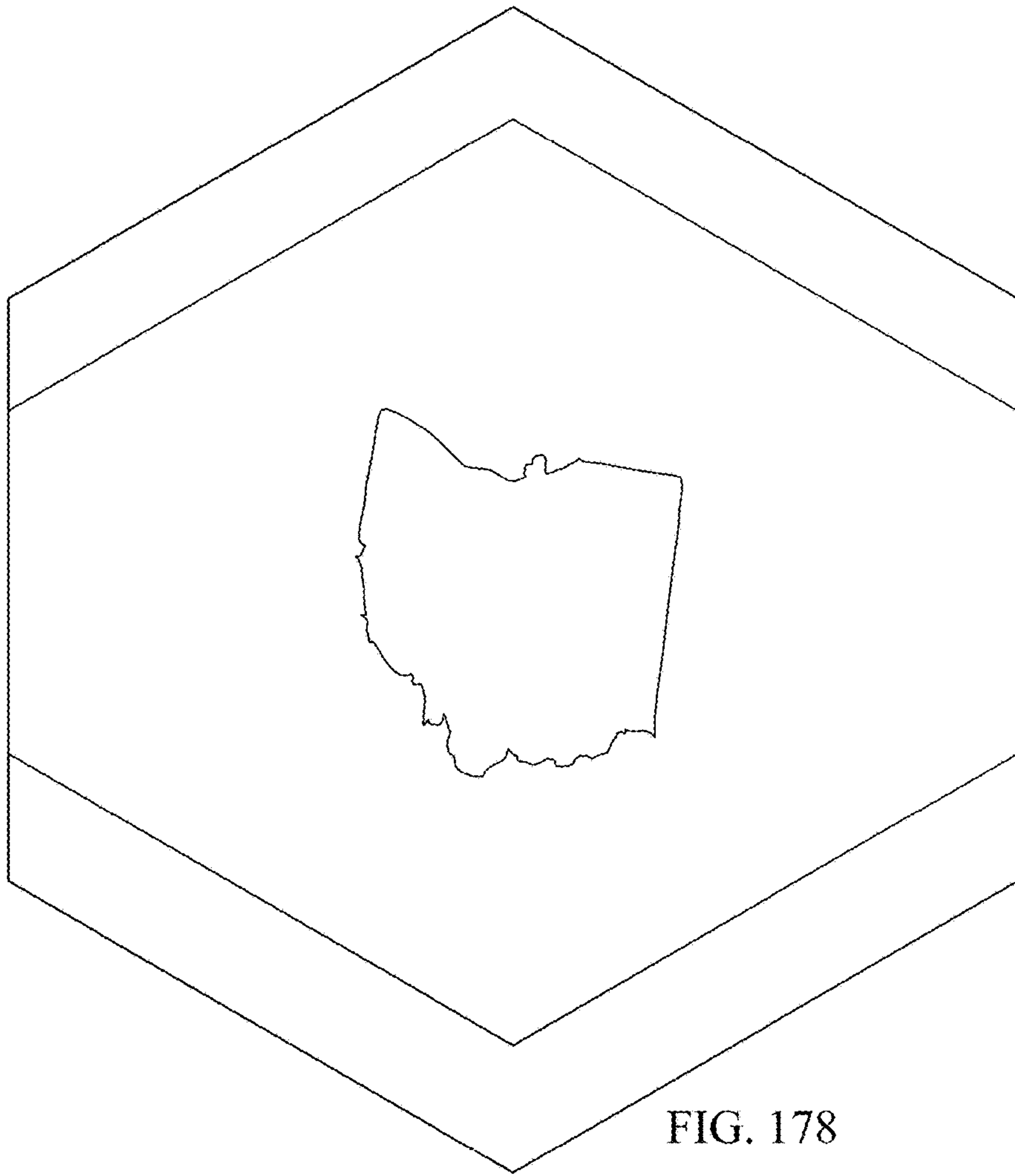

FIG. 178



FIG. 179

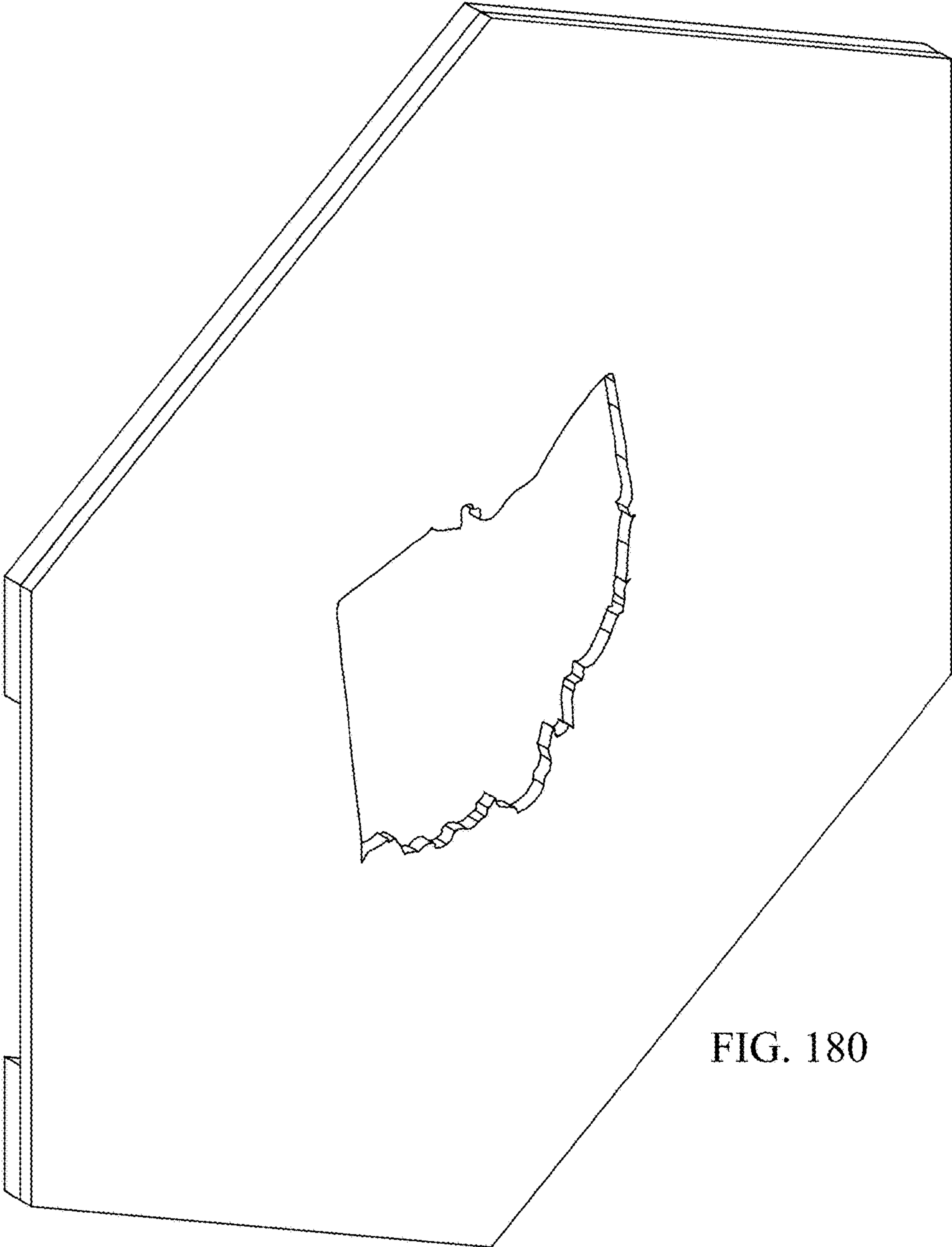

FIG. 180

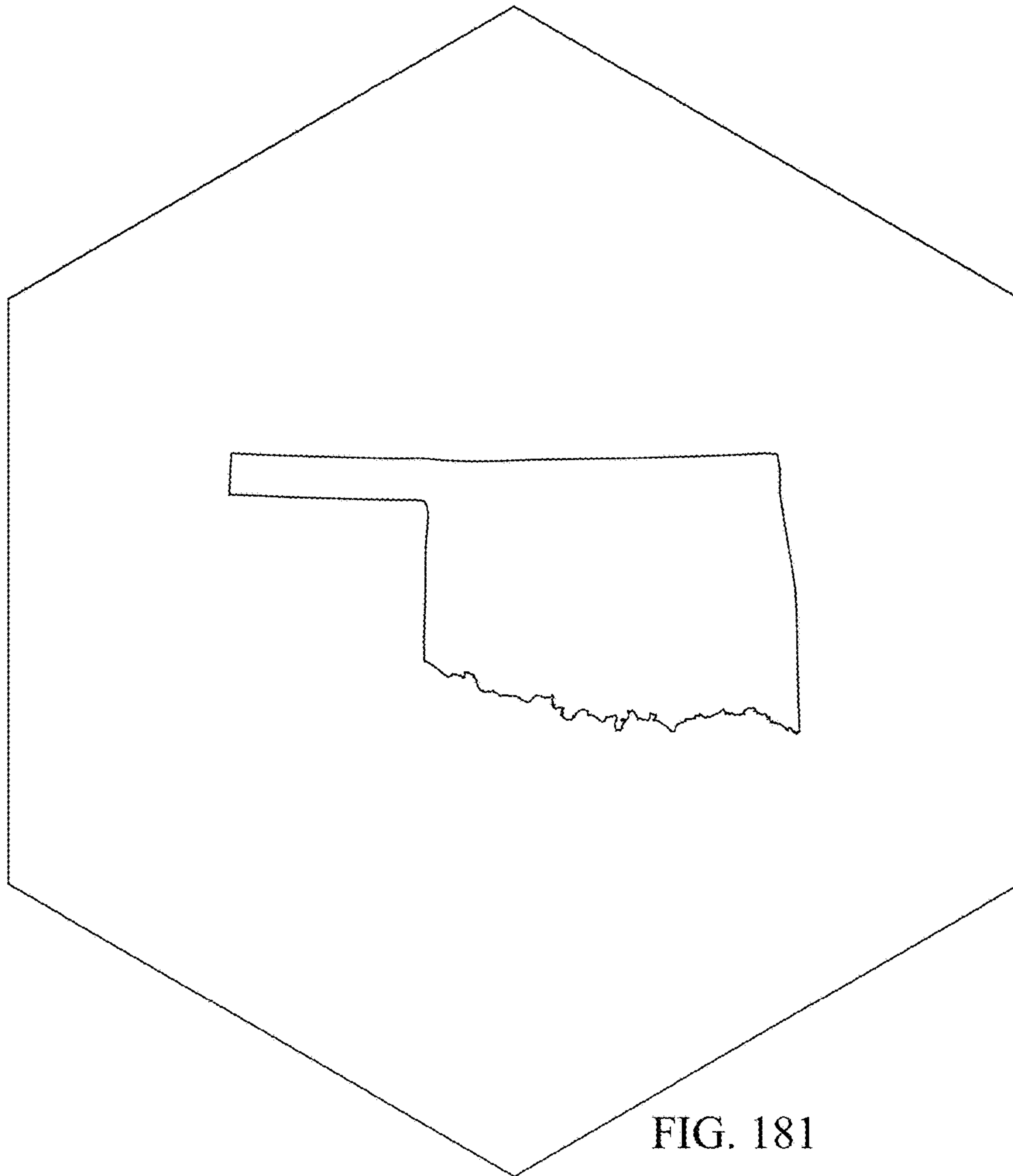

FIG. 181

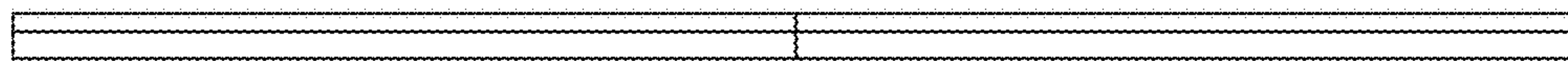

FIG. 182

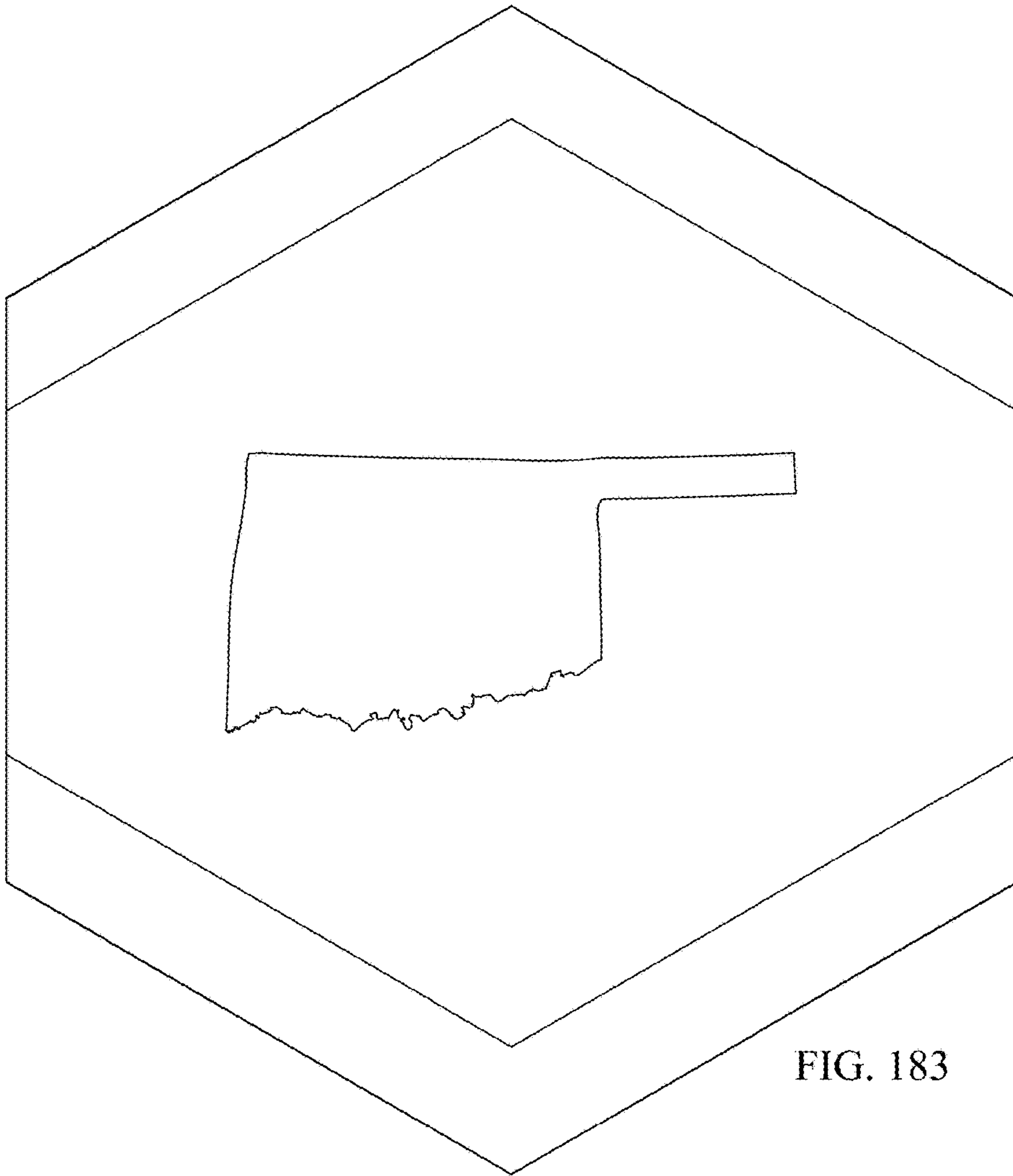

FIG. 183

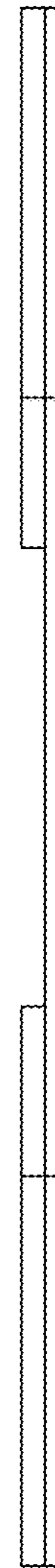

FIG. 184

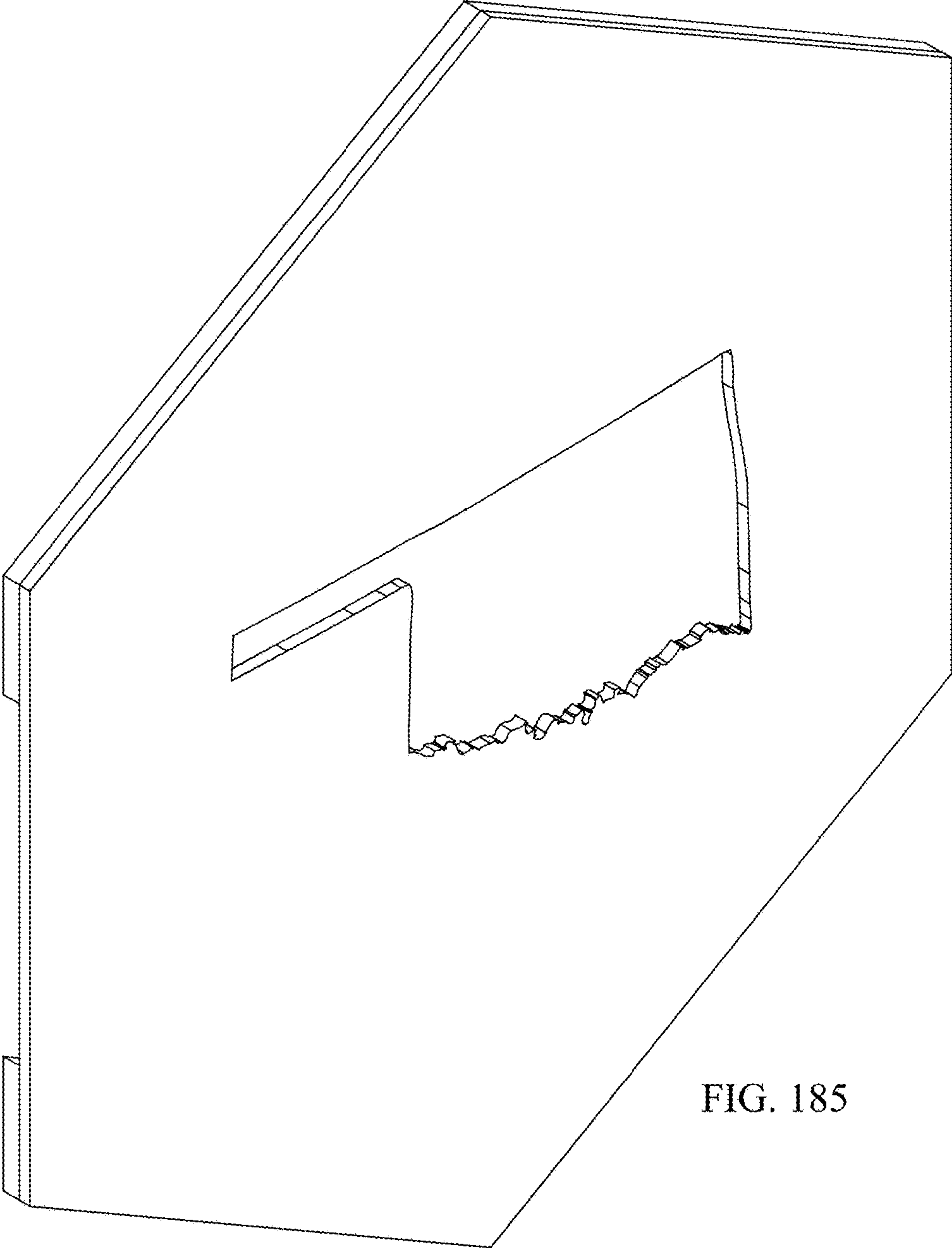

FIG. 185

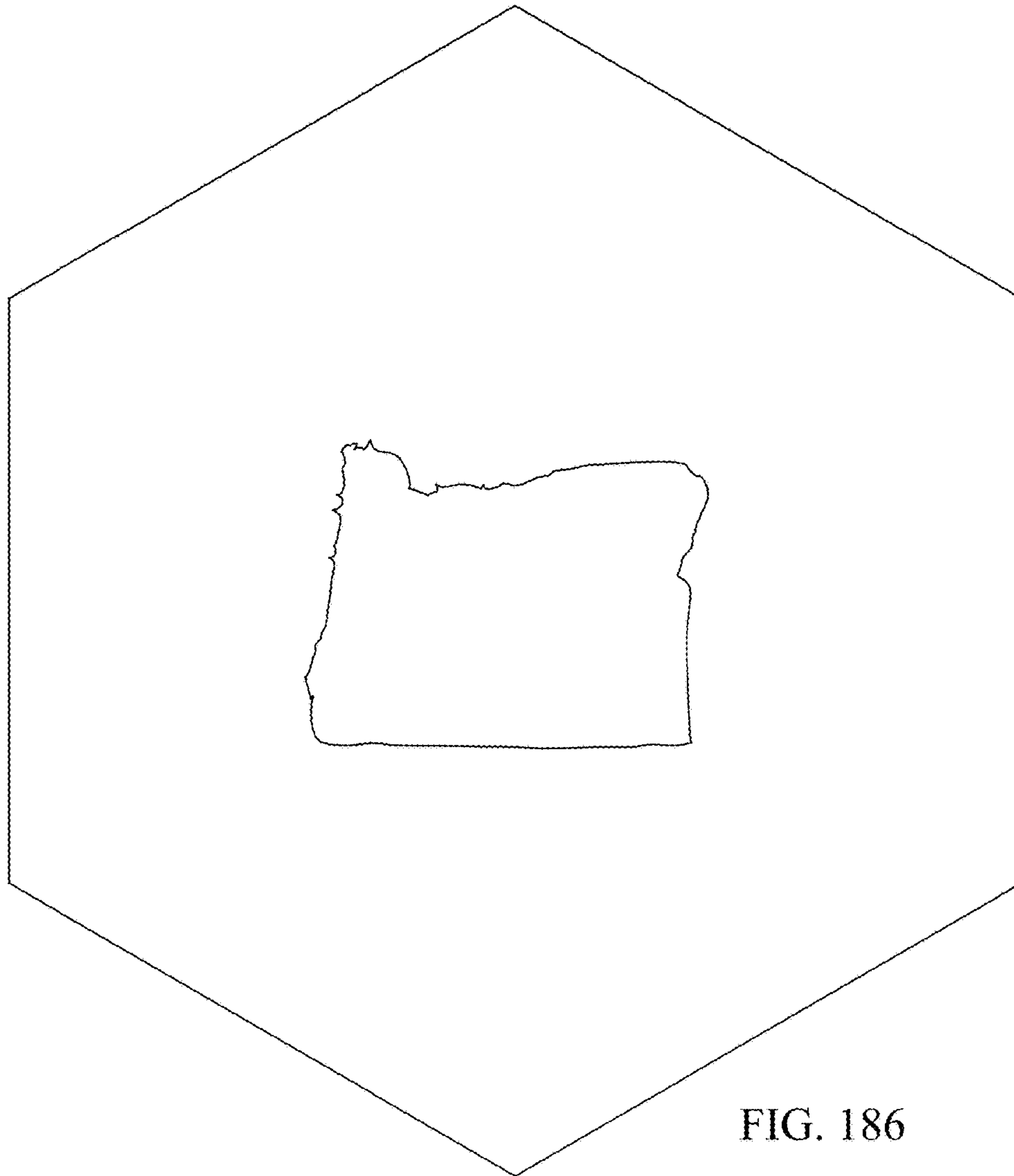

FIG. 186

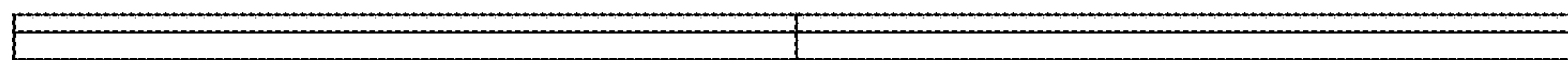

FIG. 187

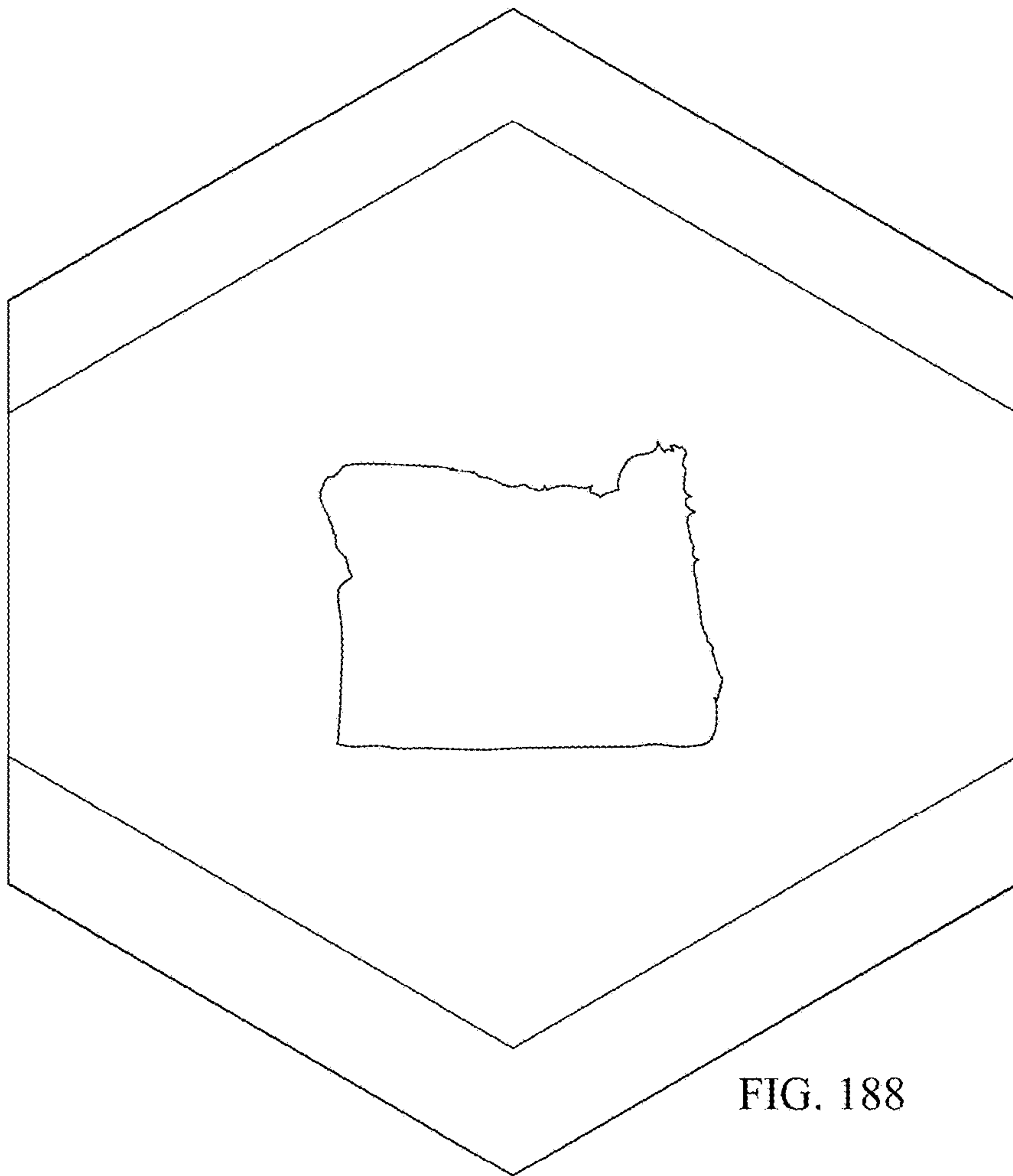

FIG. 188



FIG. 189

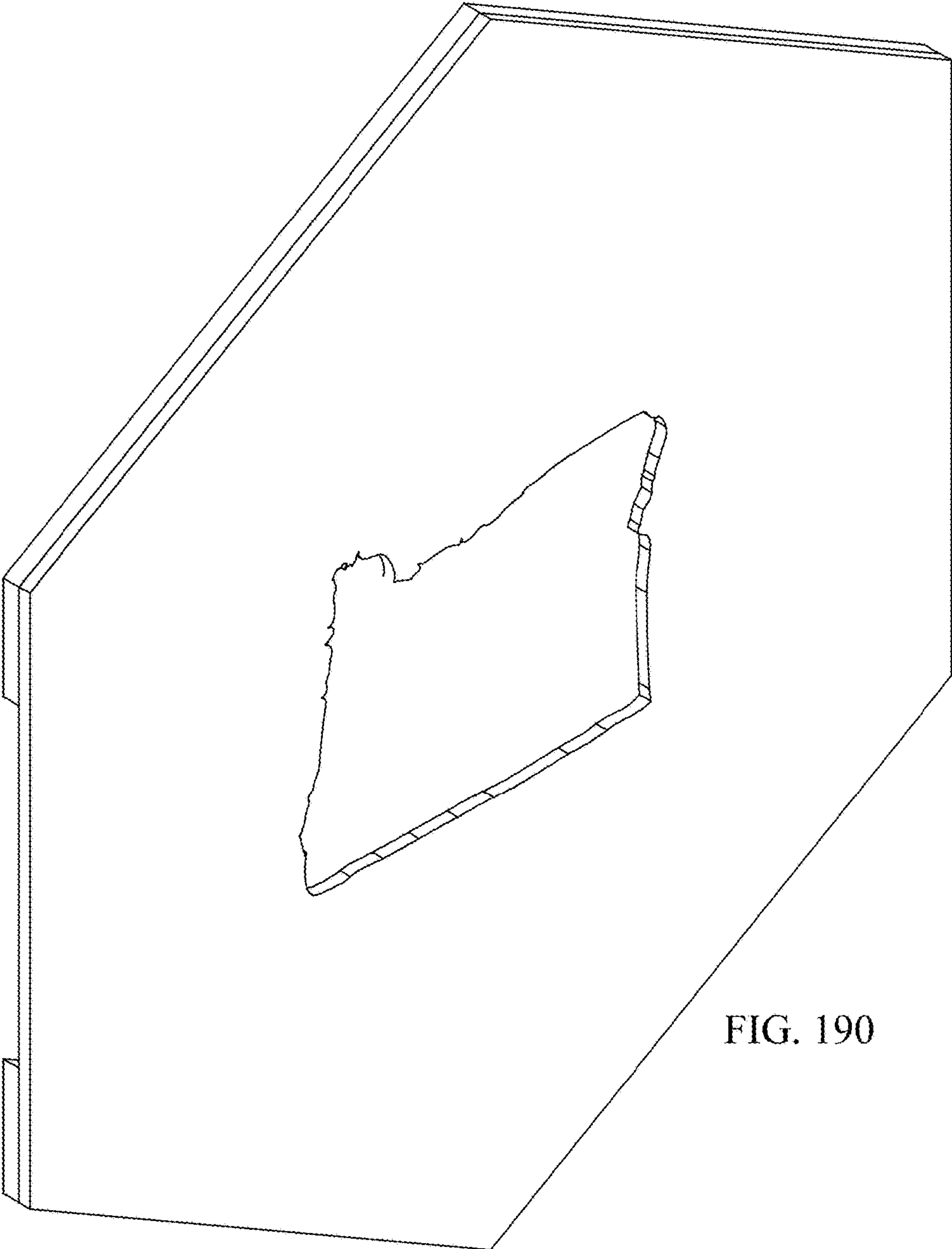
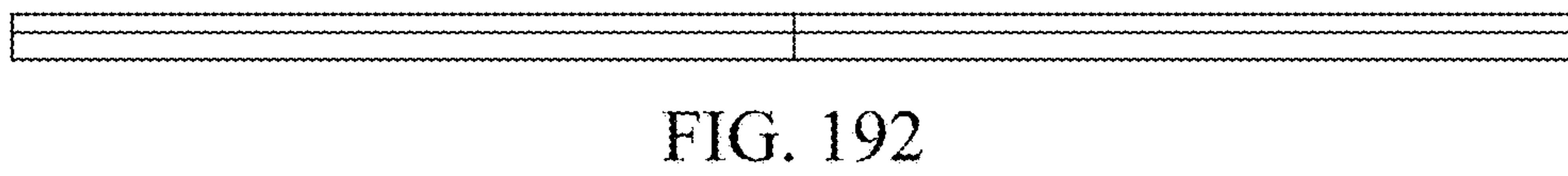
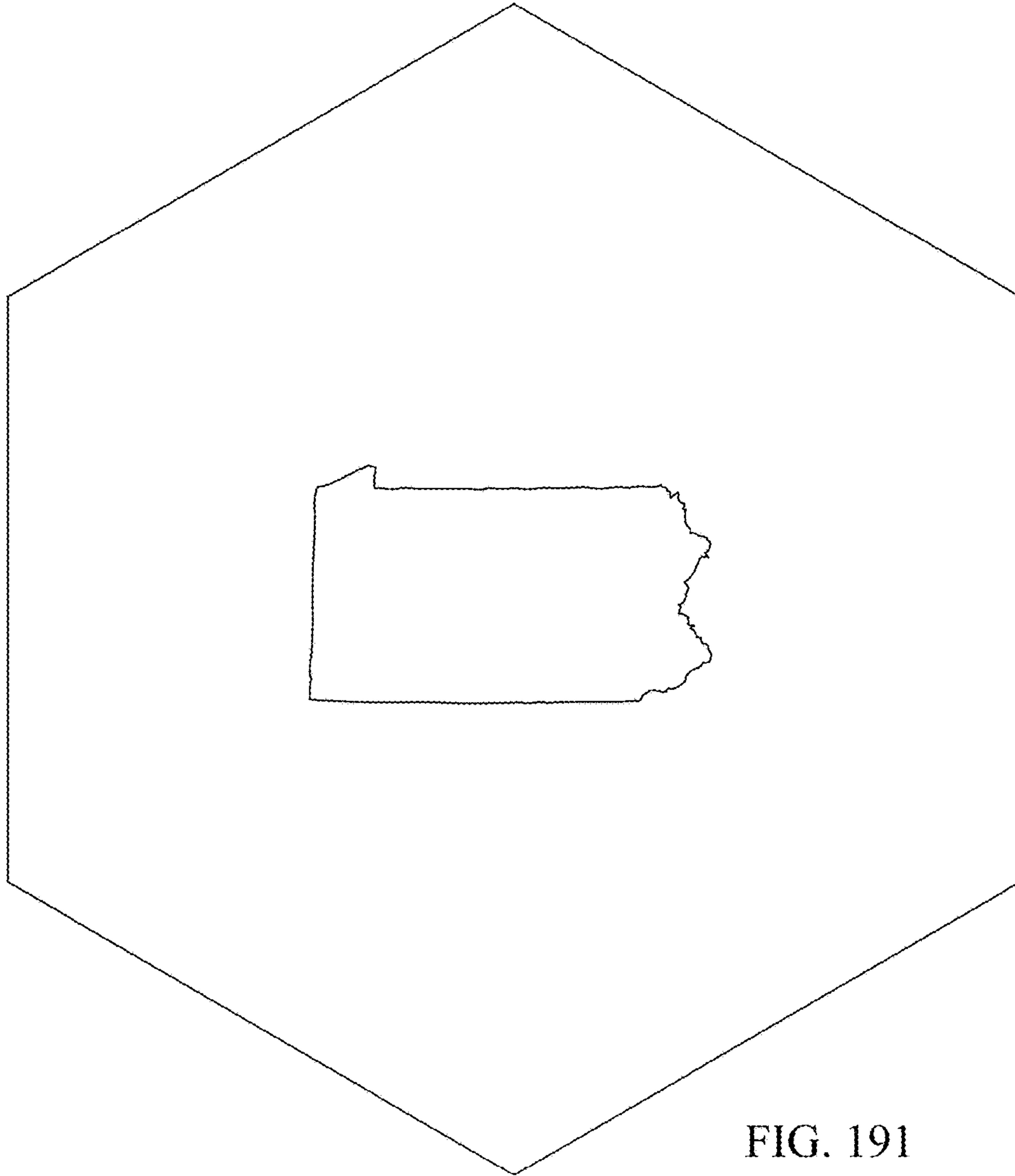

FIG. 190



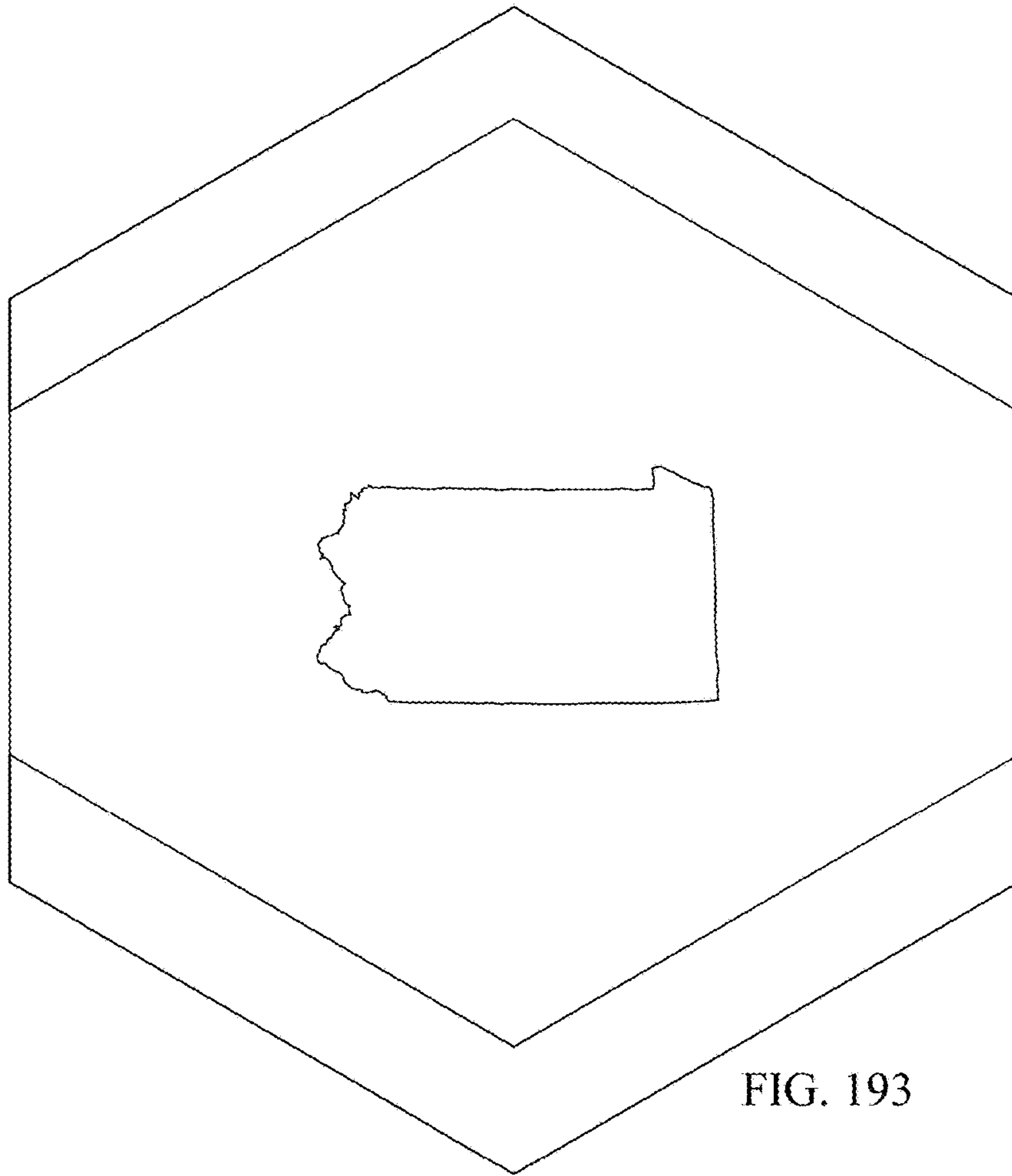

FIG. 193

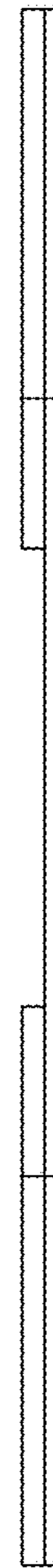

FIG. 194

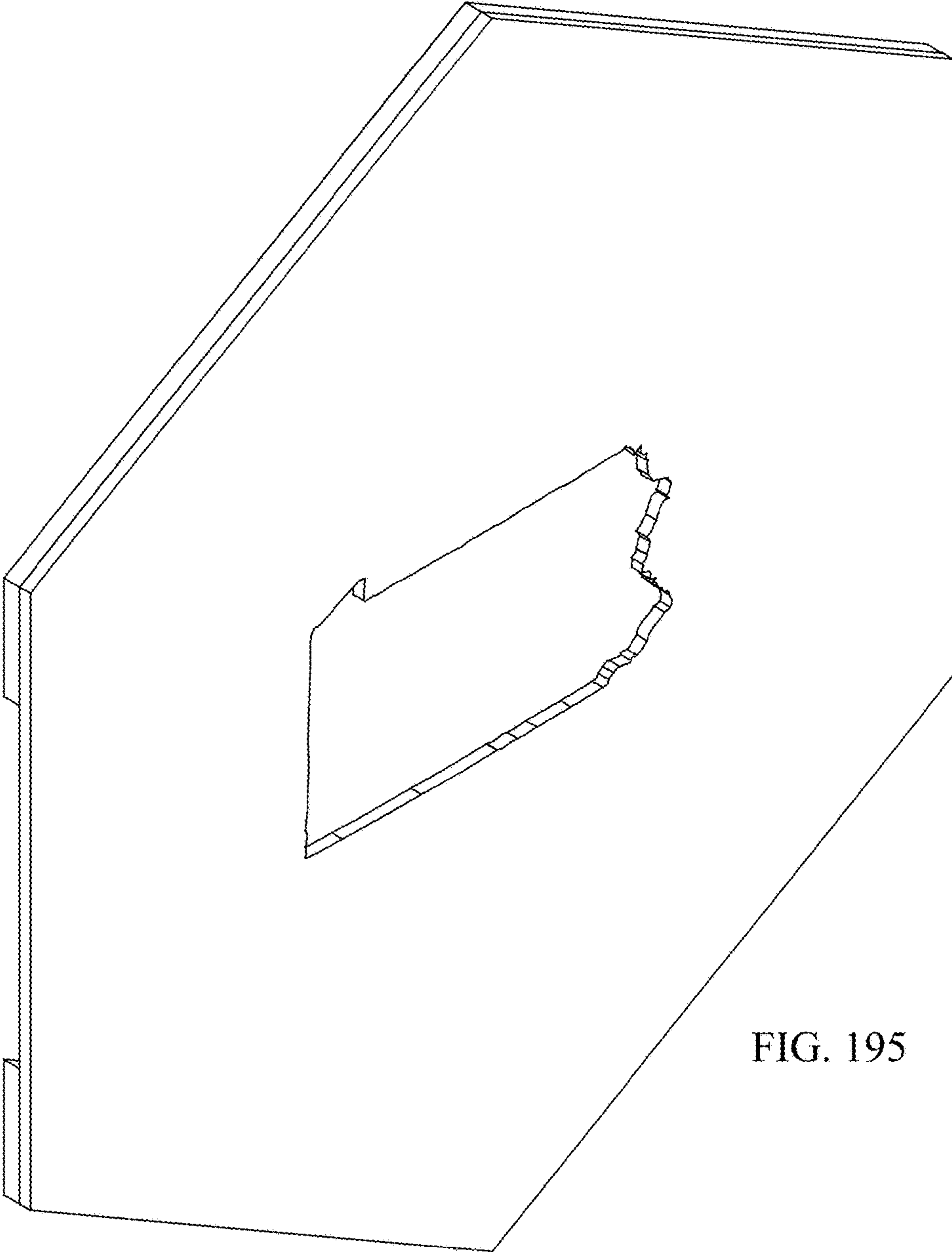

FIG. 195

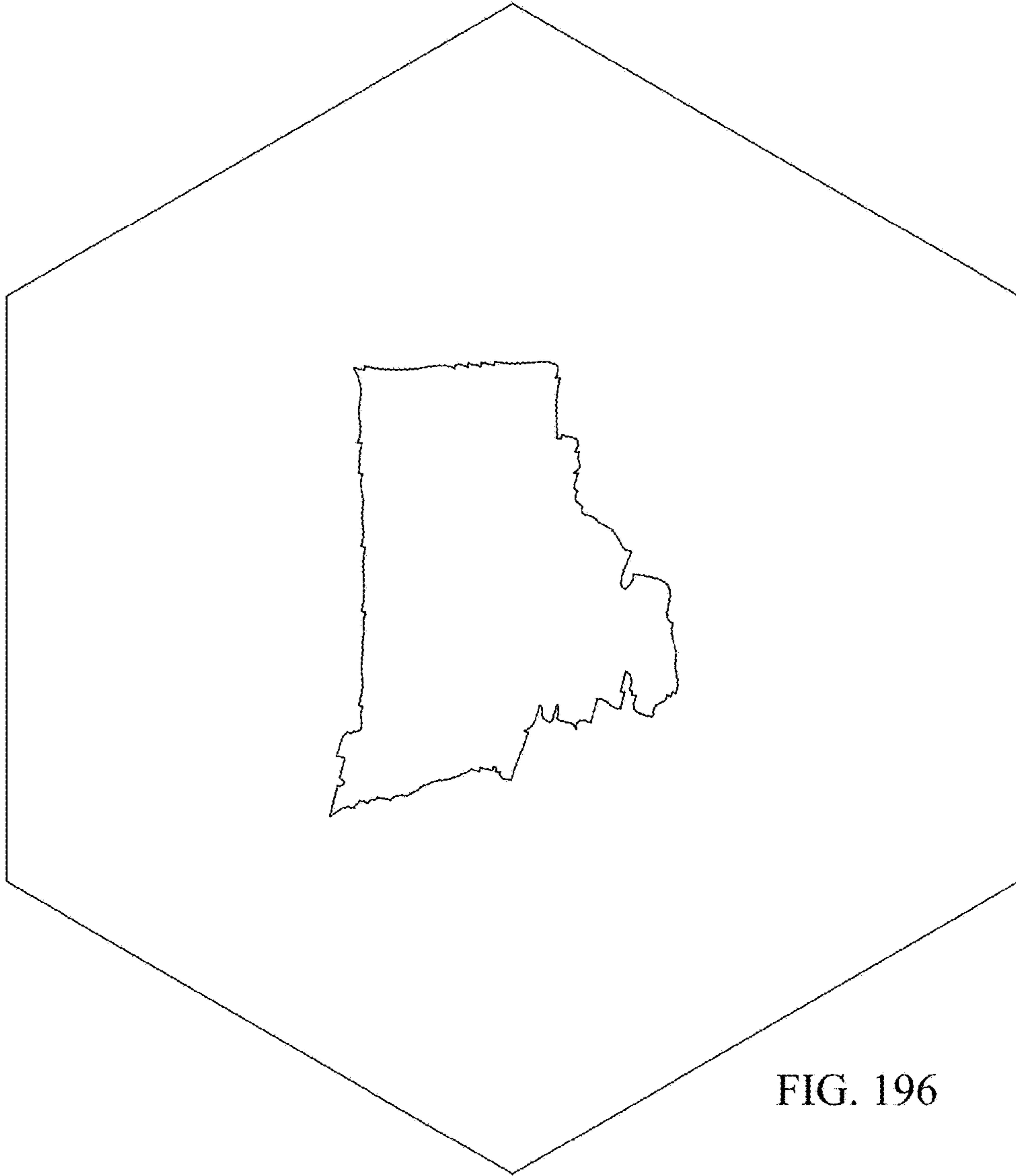

FIG. 196

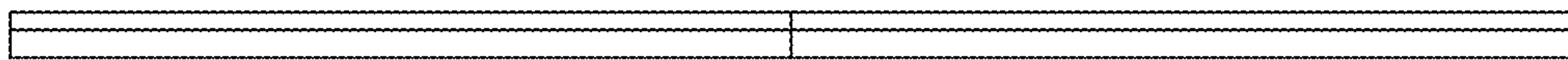

FIG. 197

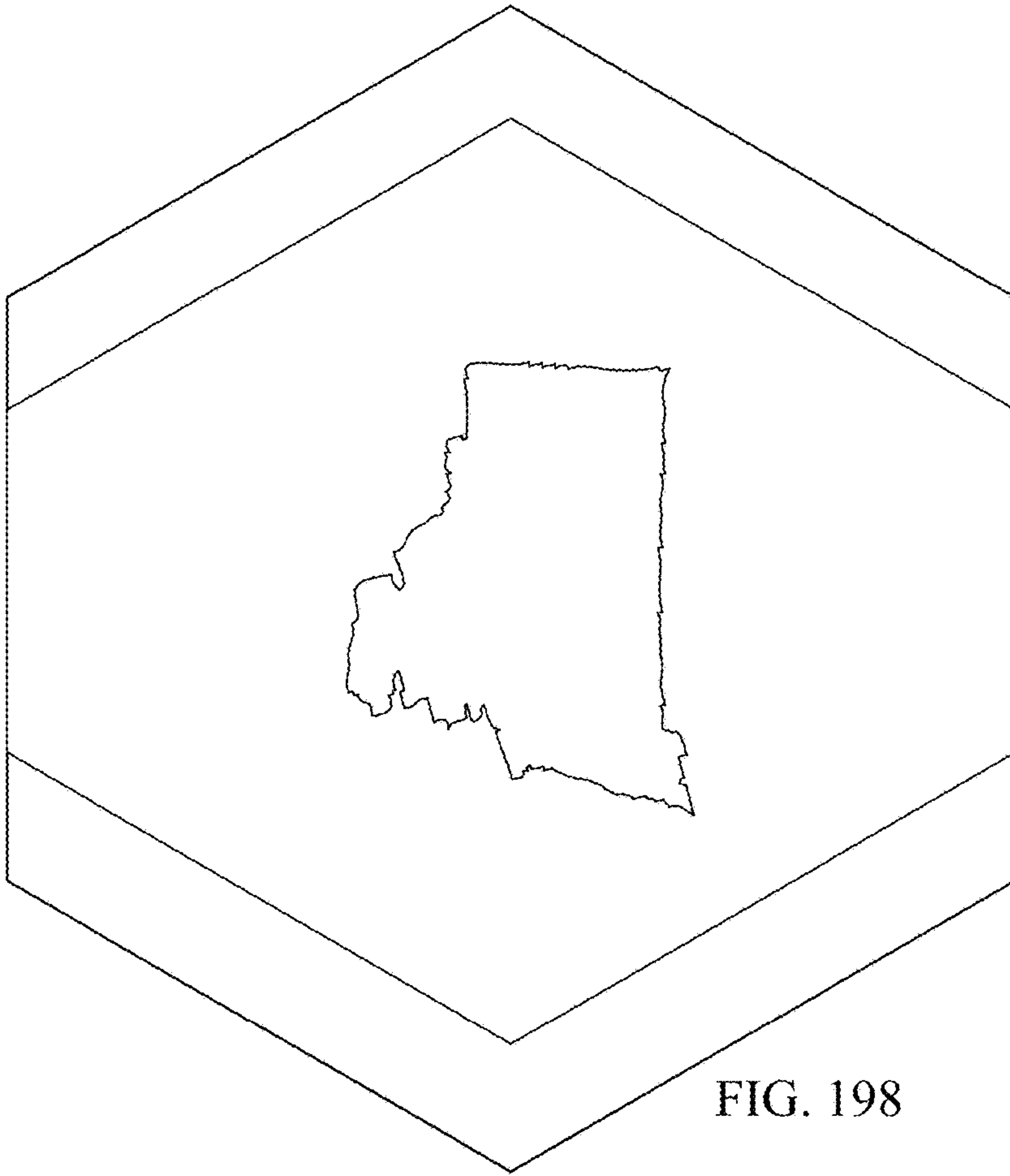

FIG. 198

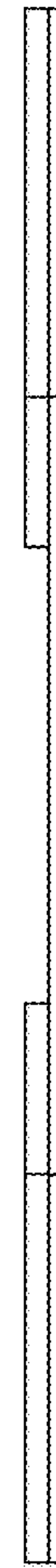

FIG. 199

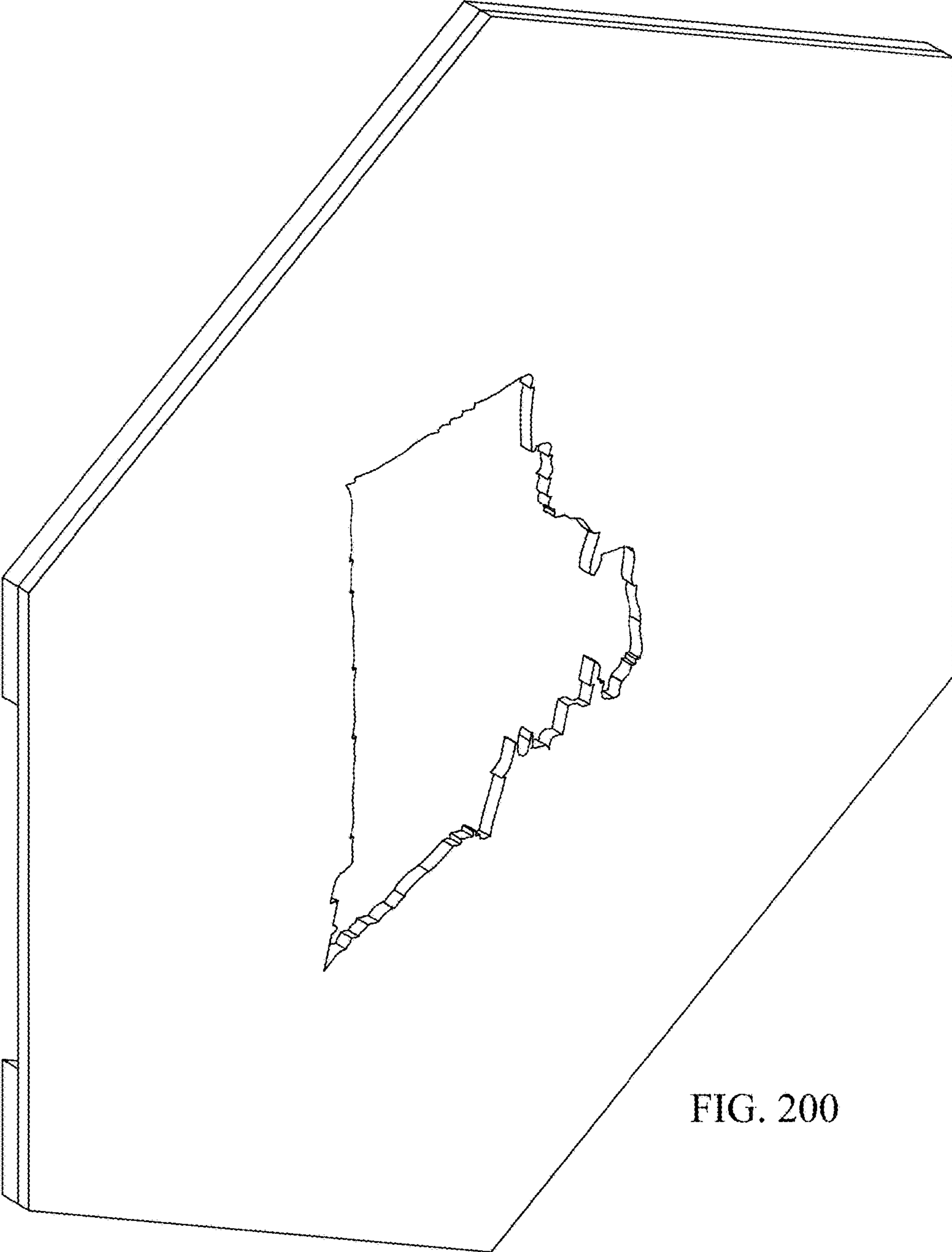

FIG. 200

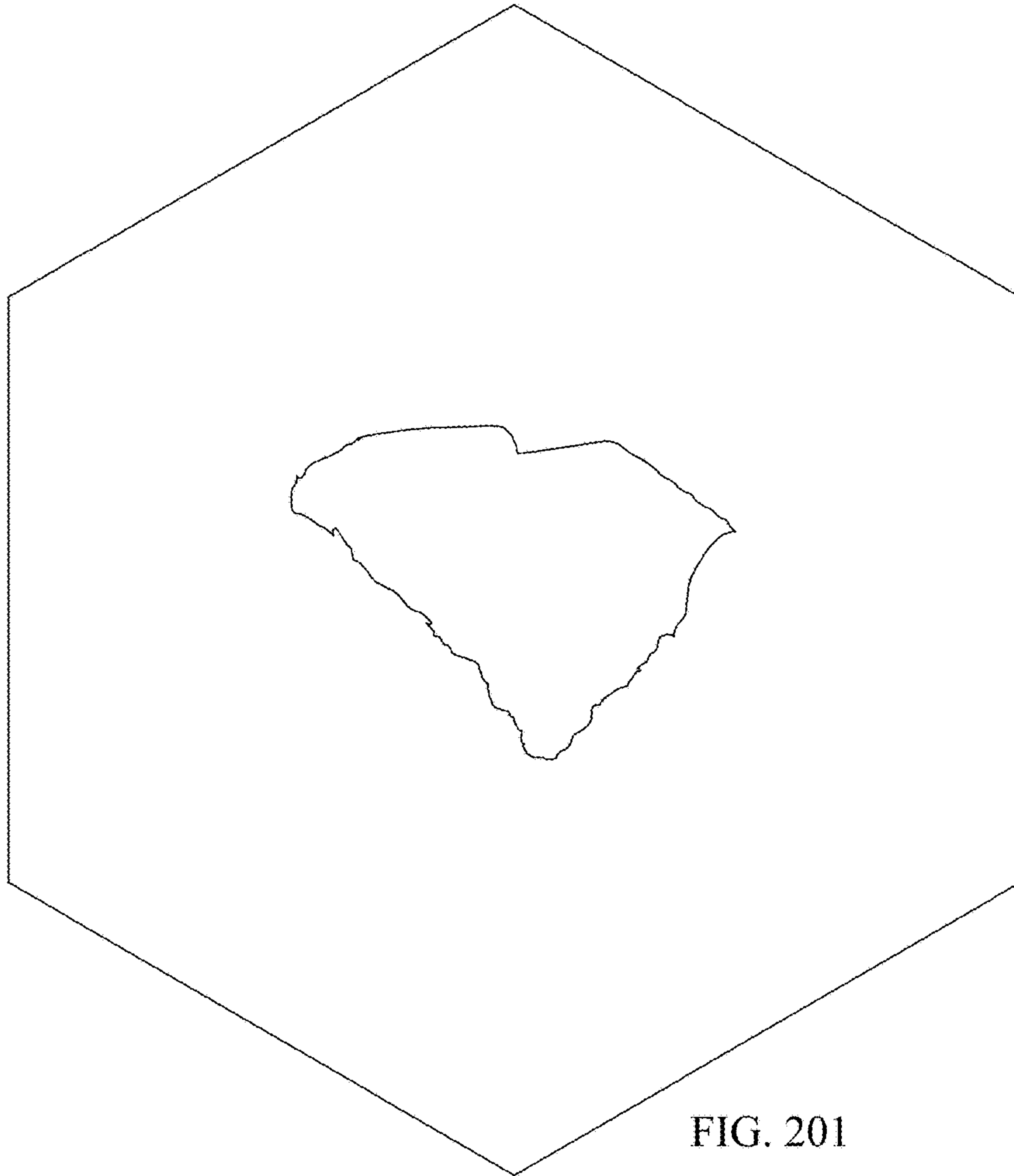

FIG. 201

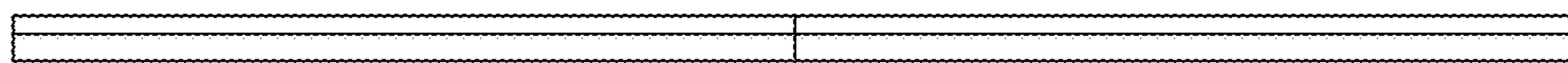

FIG. 202

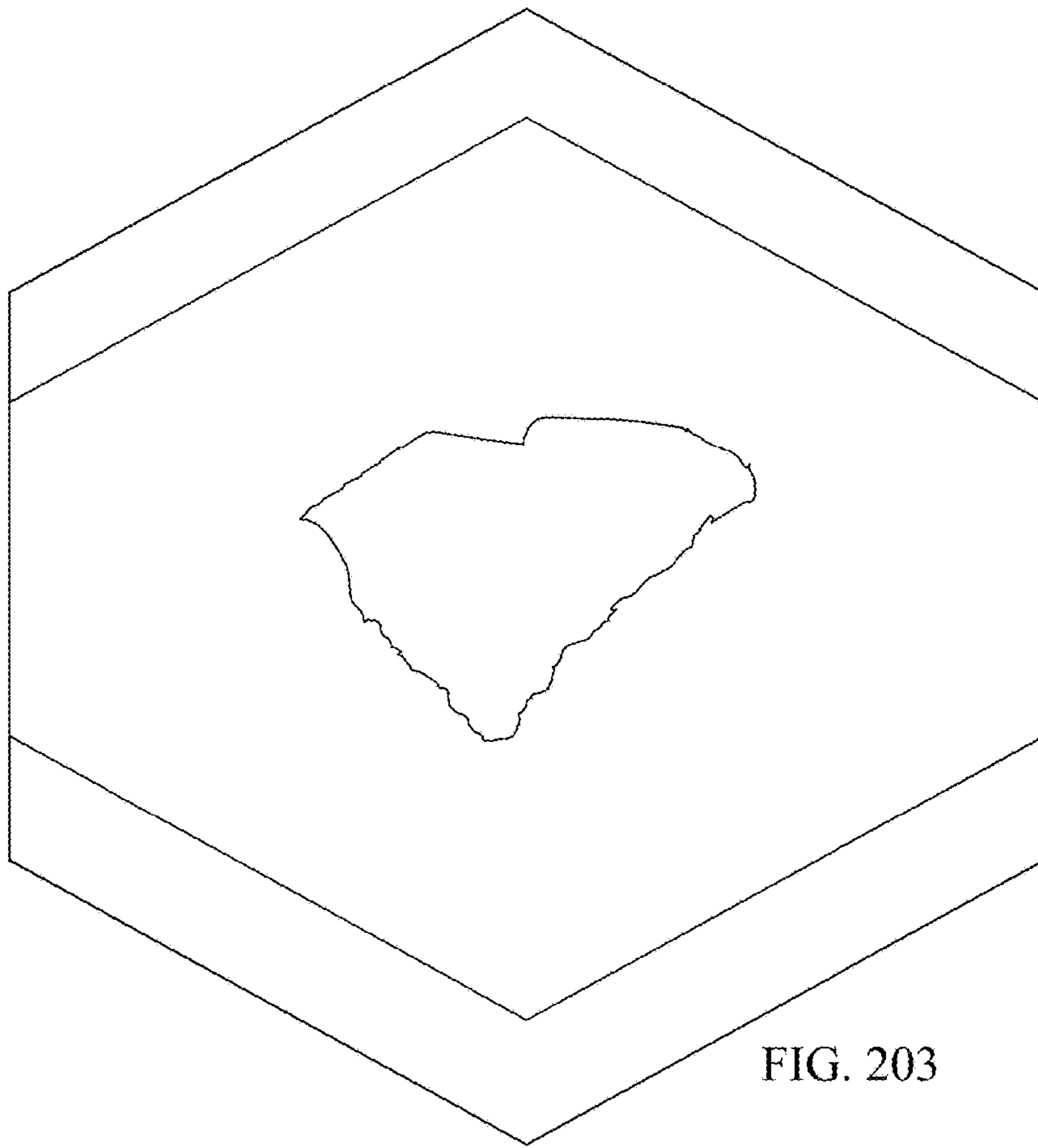

FIG. 203

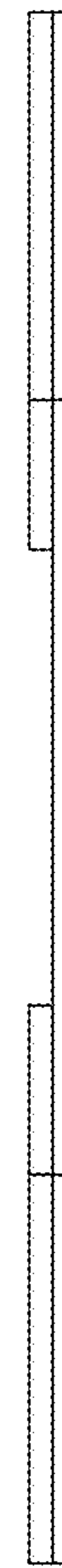

FIG. 204

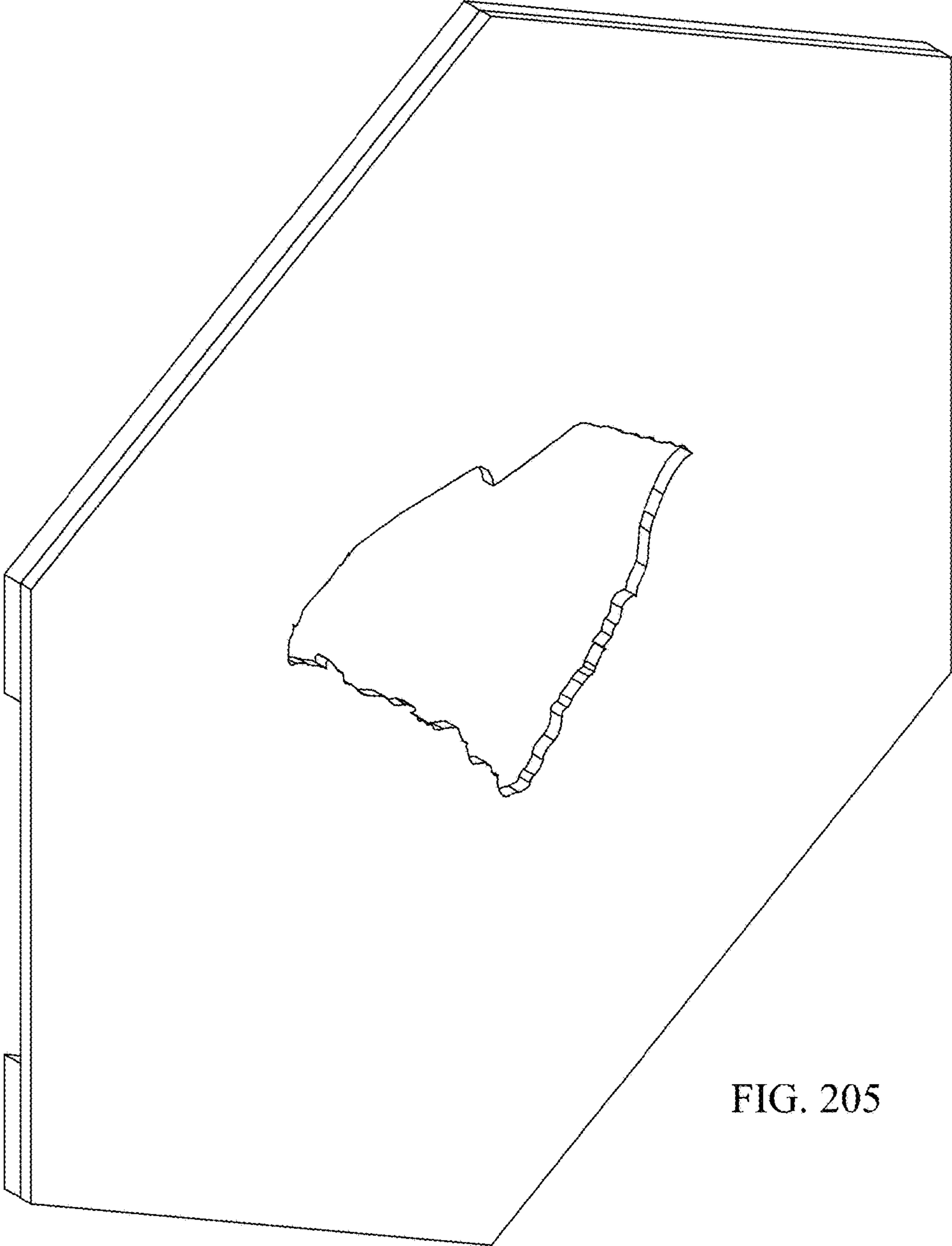

FIG. 205

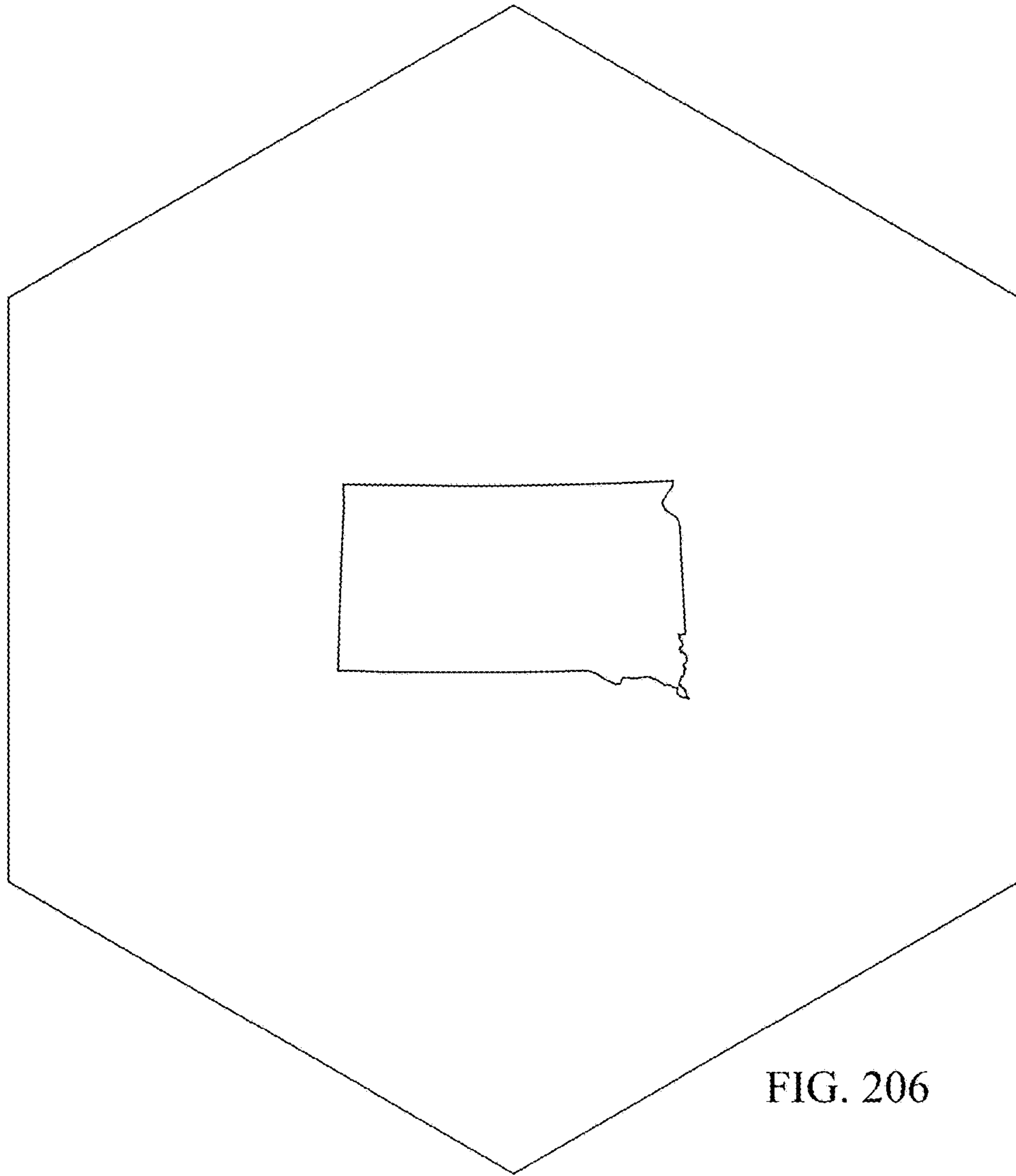

FIG. 206

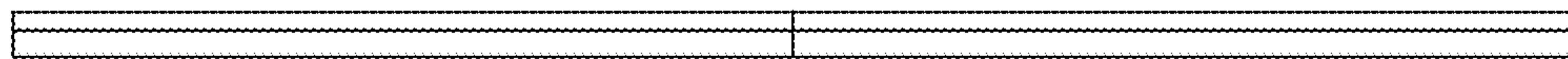

FIG. 207

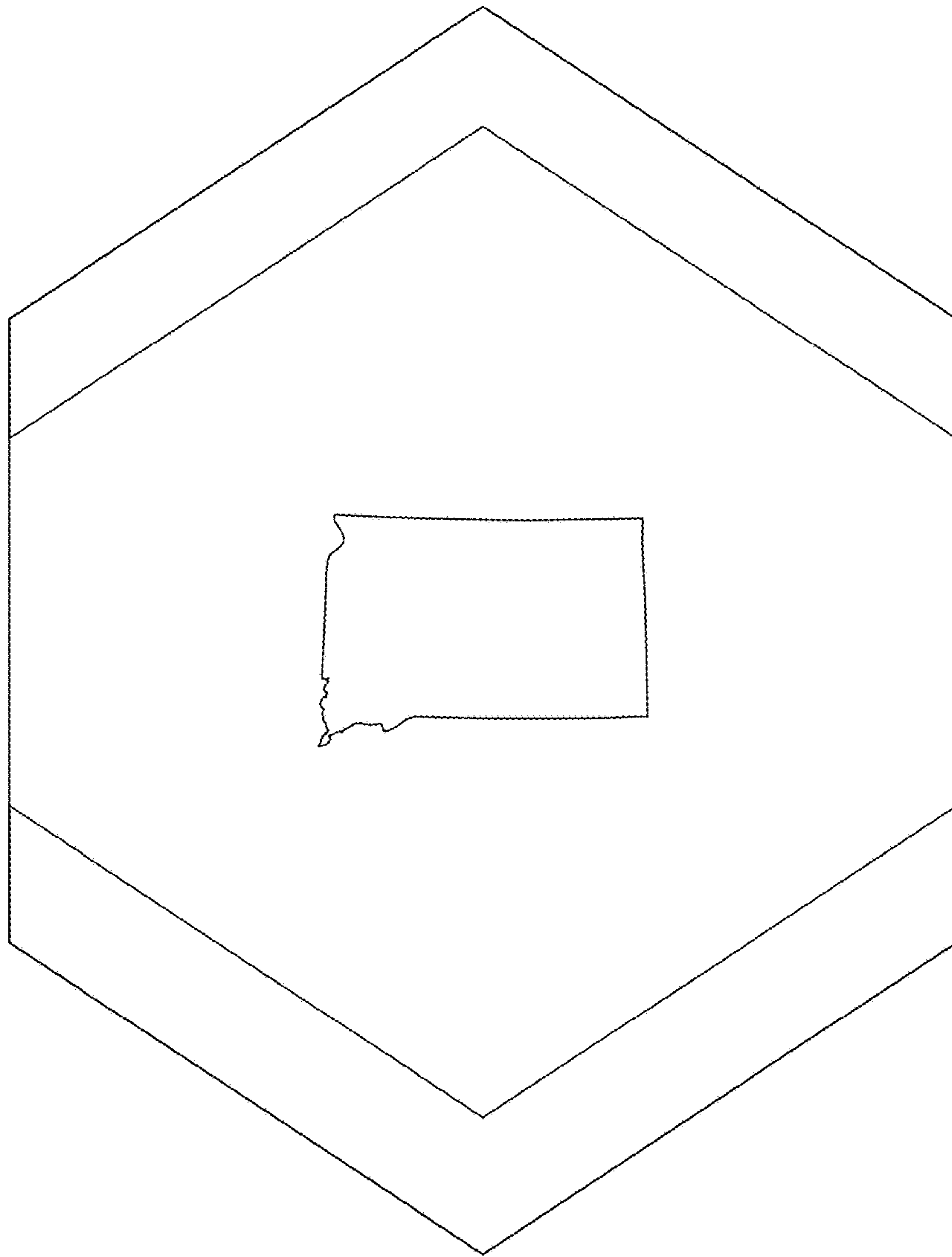

FIG. 208



FIG. 209

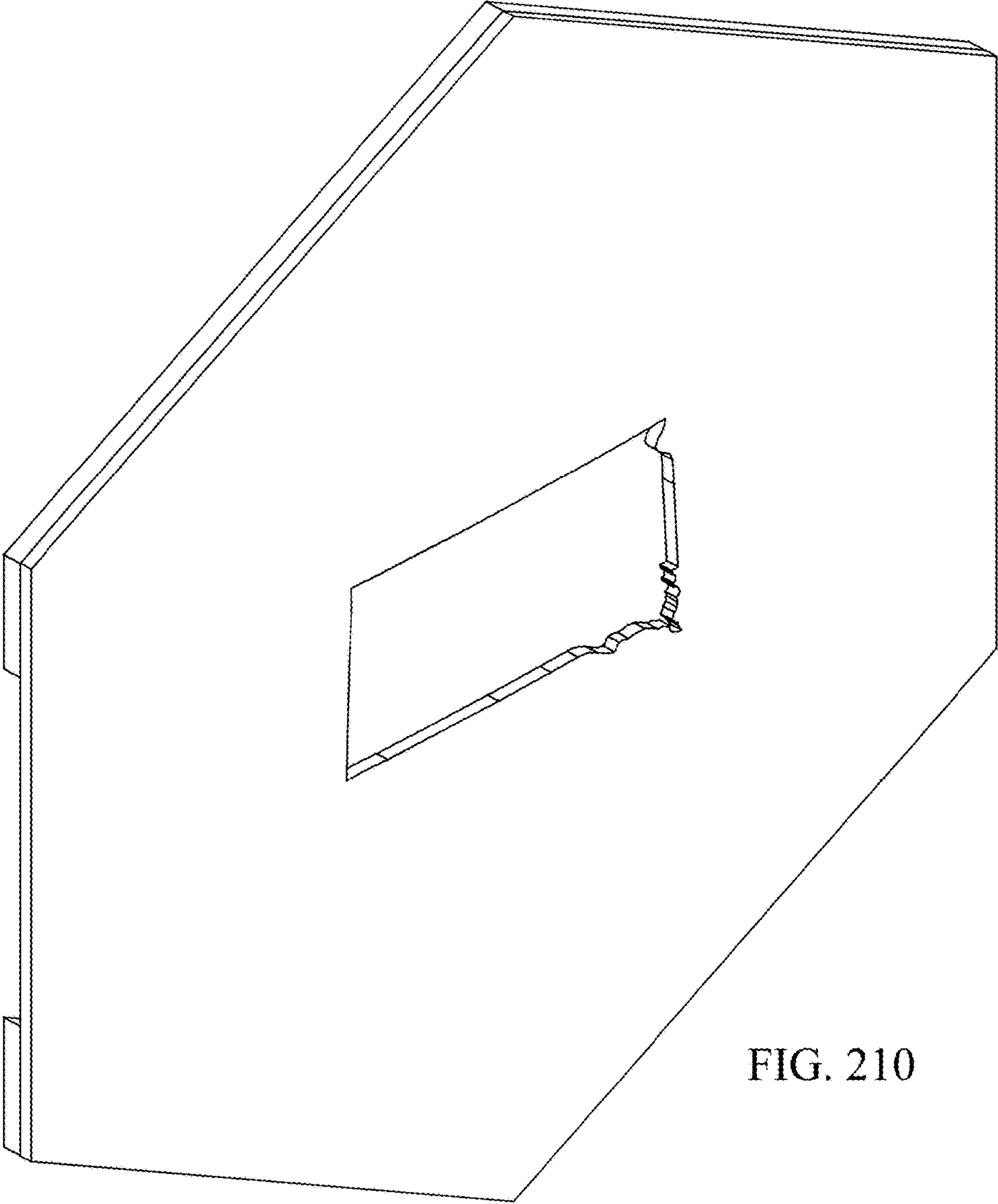

FIG. 210

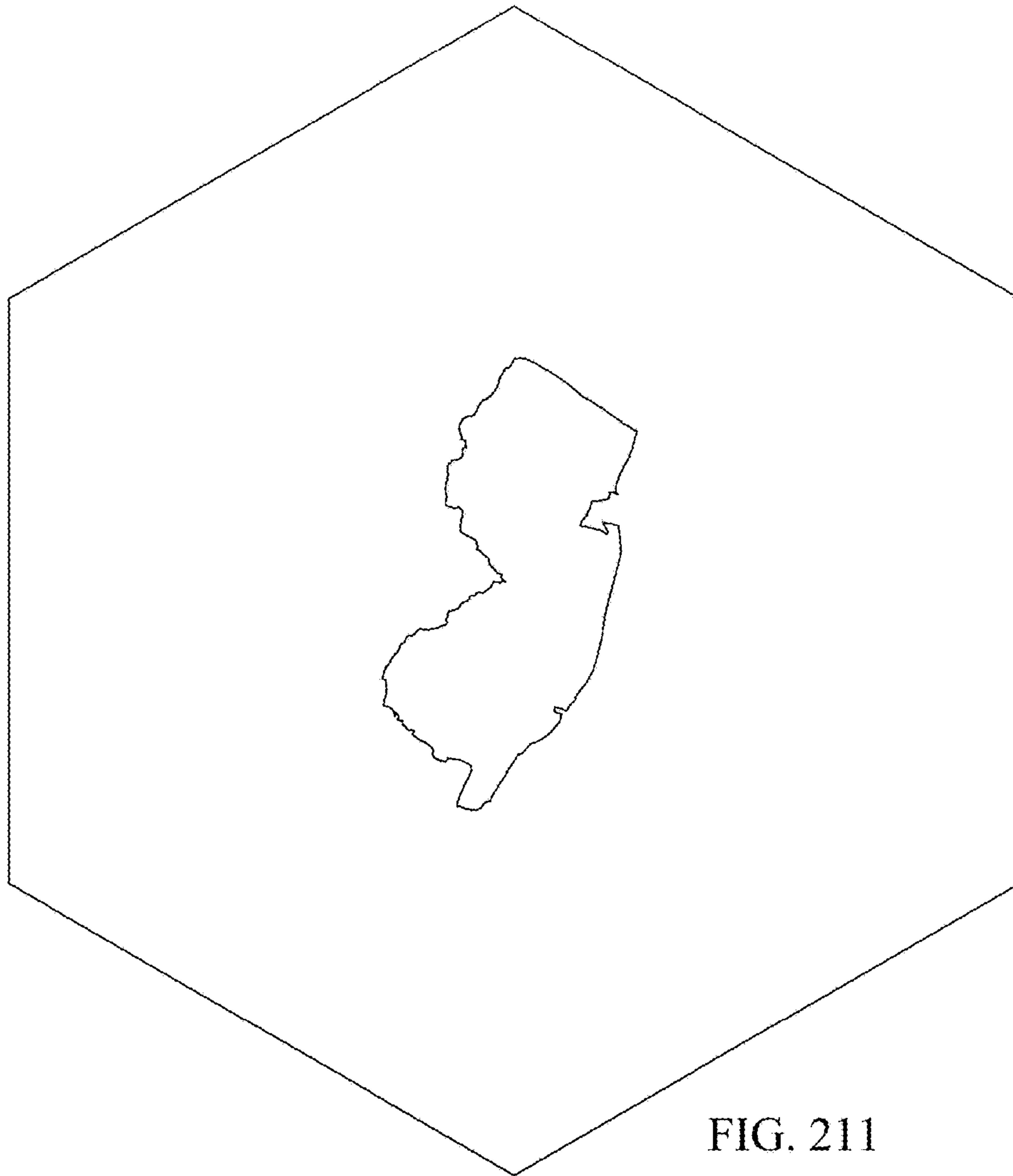

FIG. 211

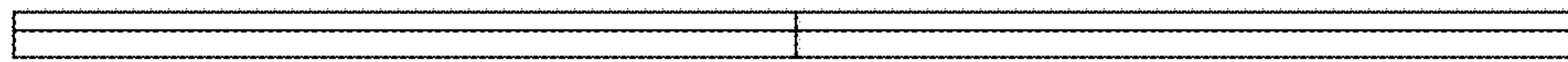

FIG. 212

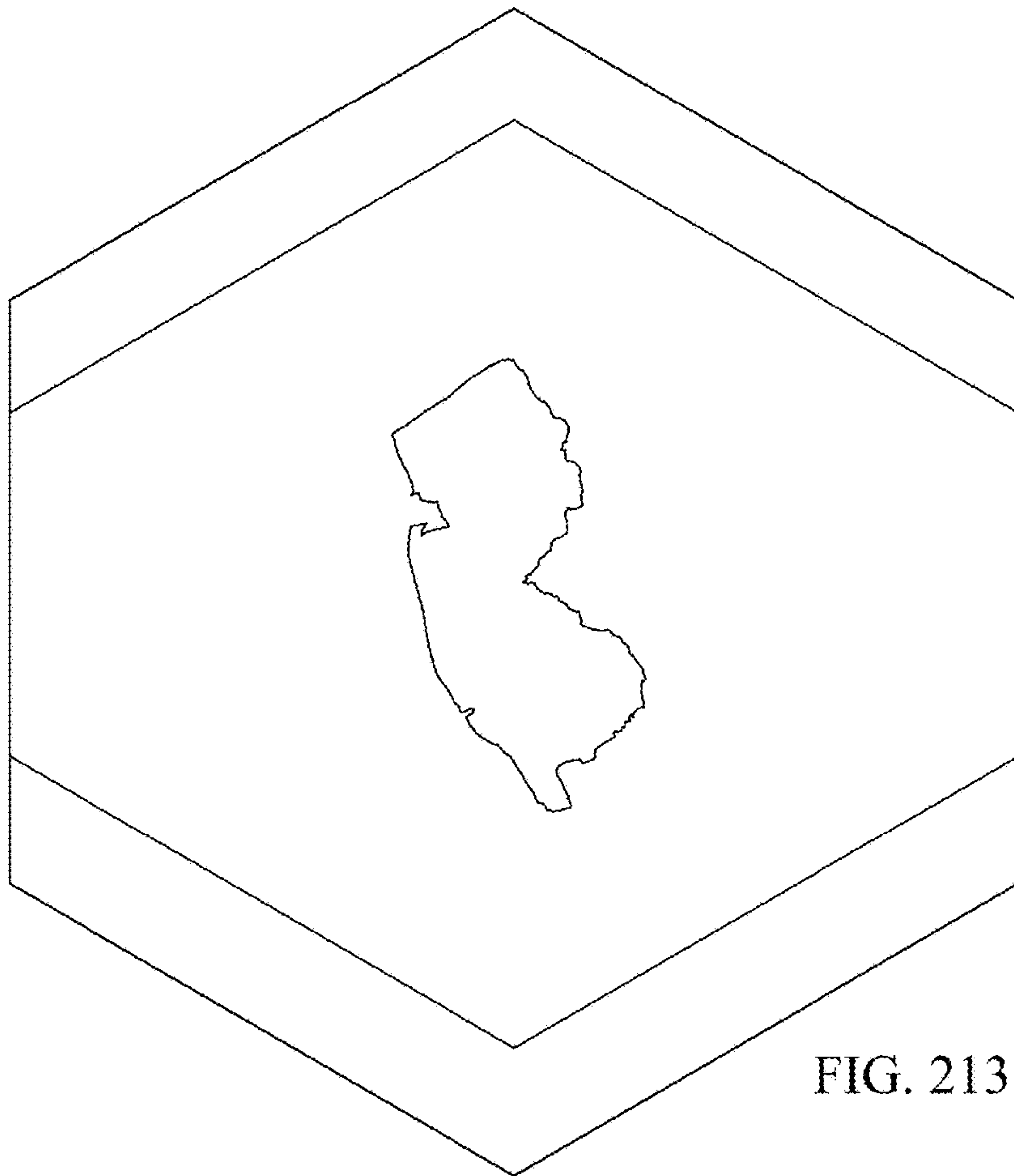

FIG. 213



FIG. 214

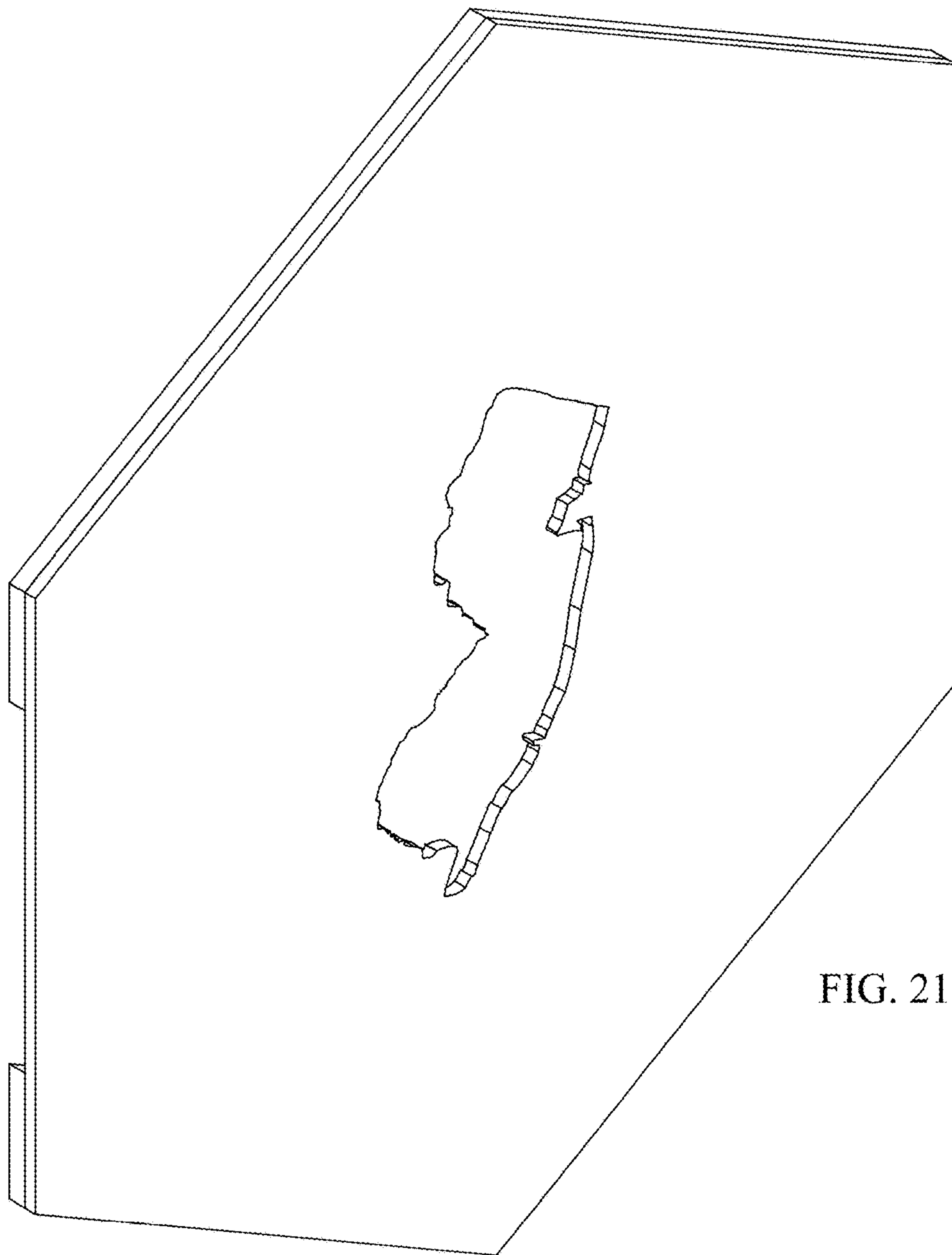

FIG. 215

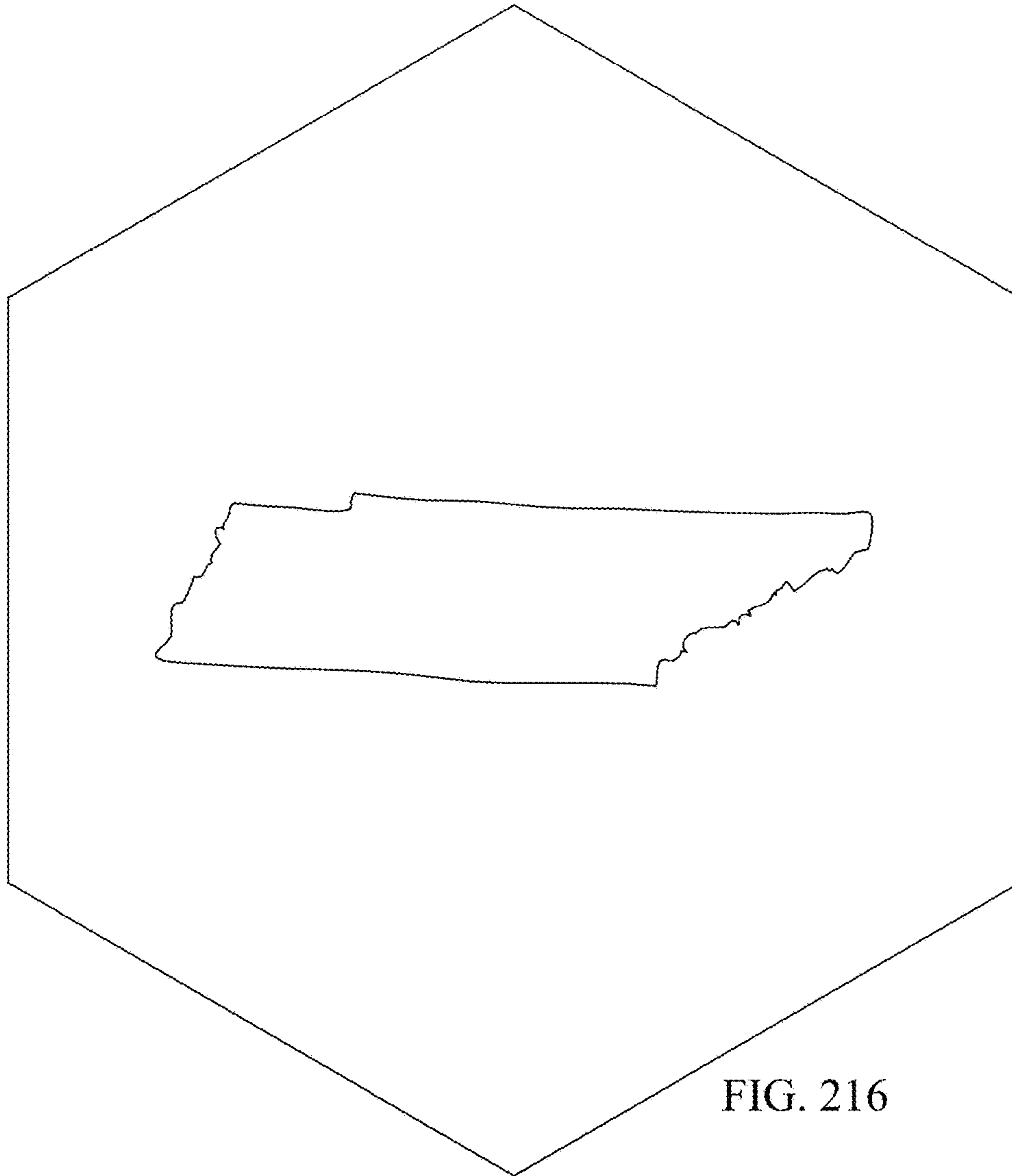

FIG. 216

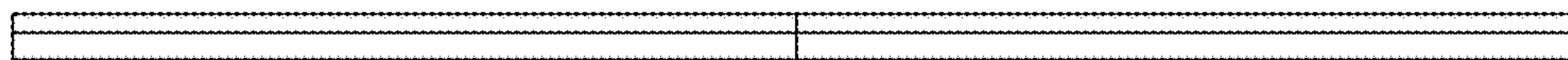

FIG. 217

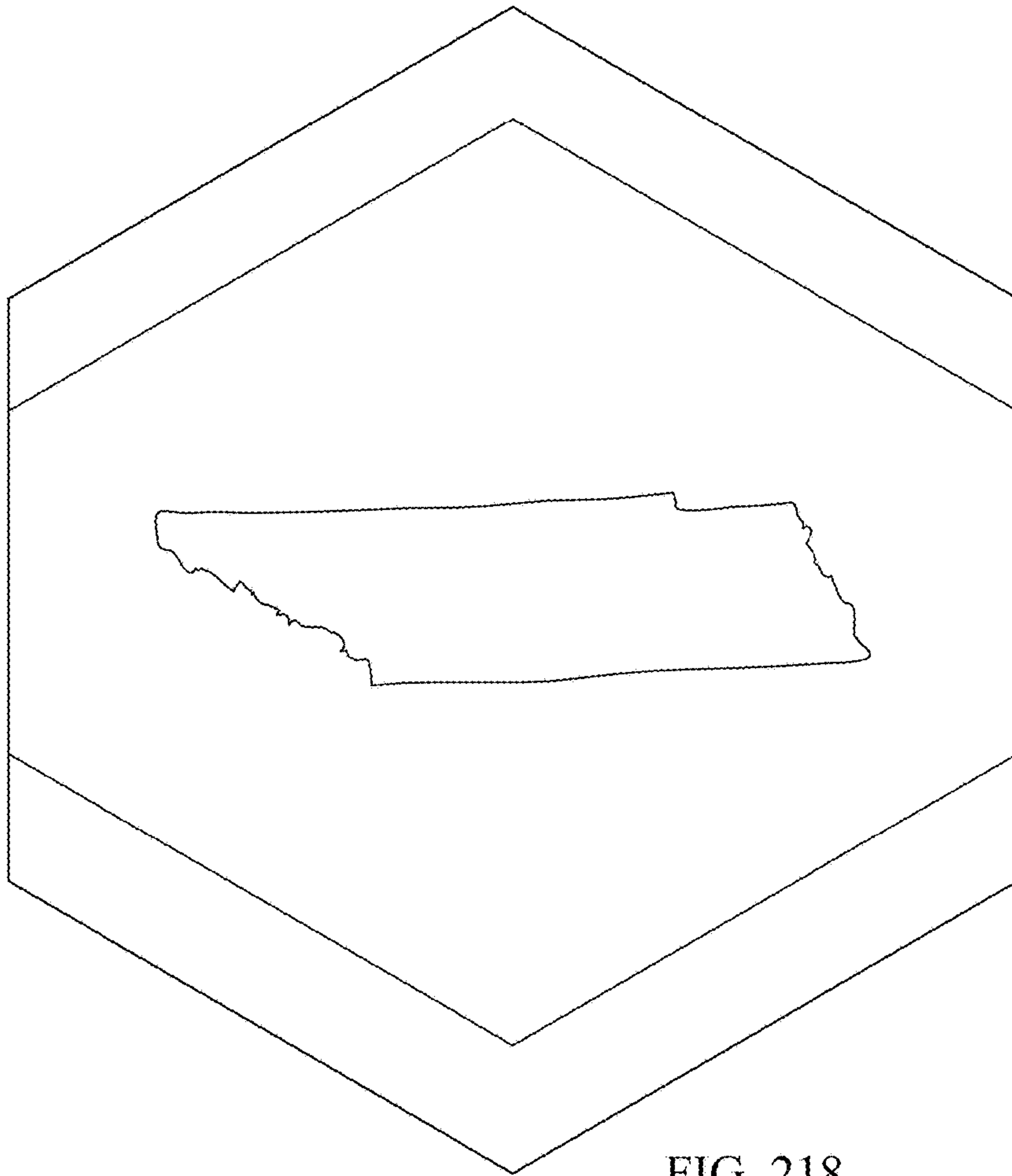

FIG. 218

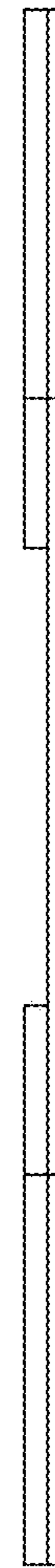

FIG. 219

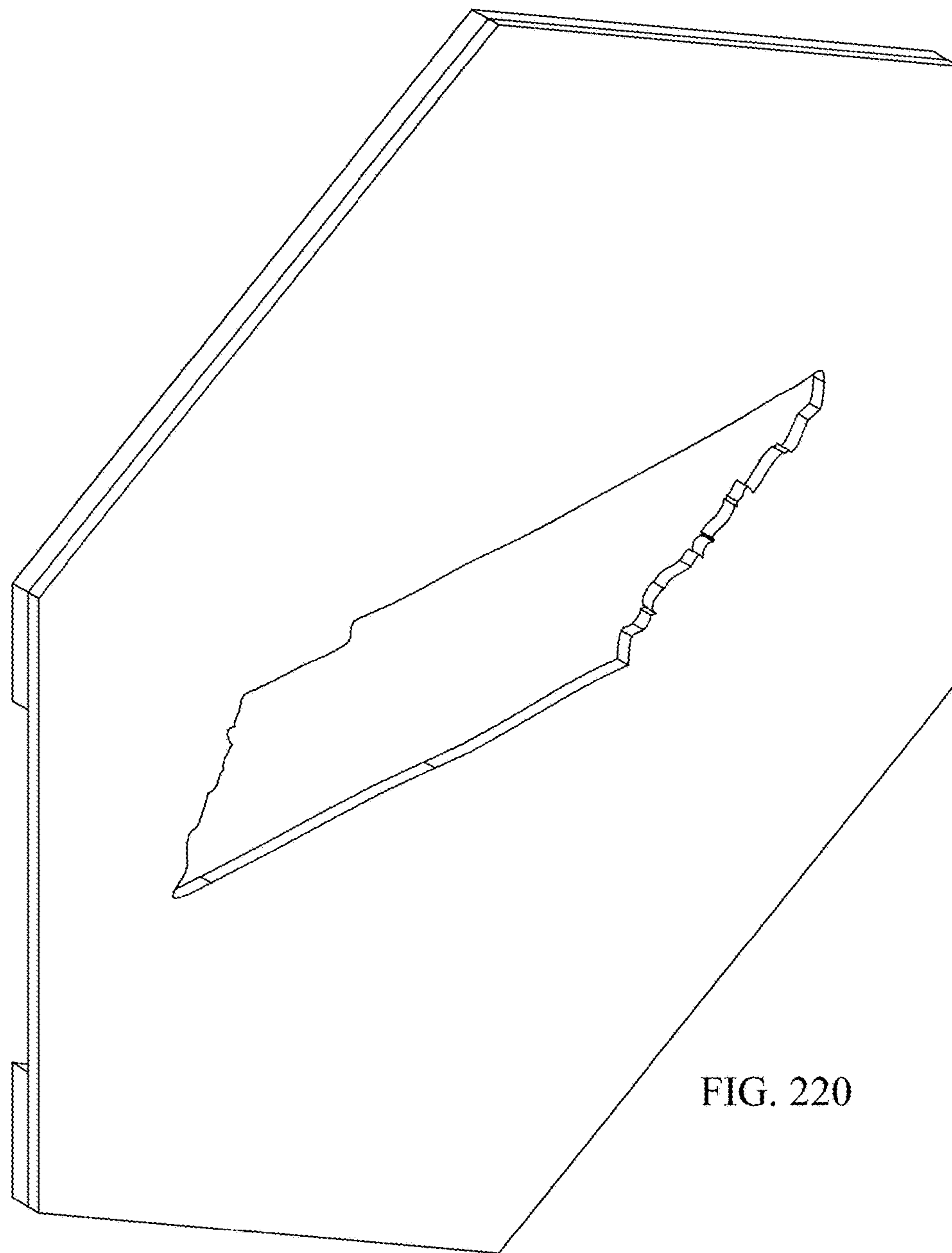

FIG. 220

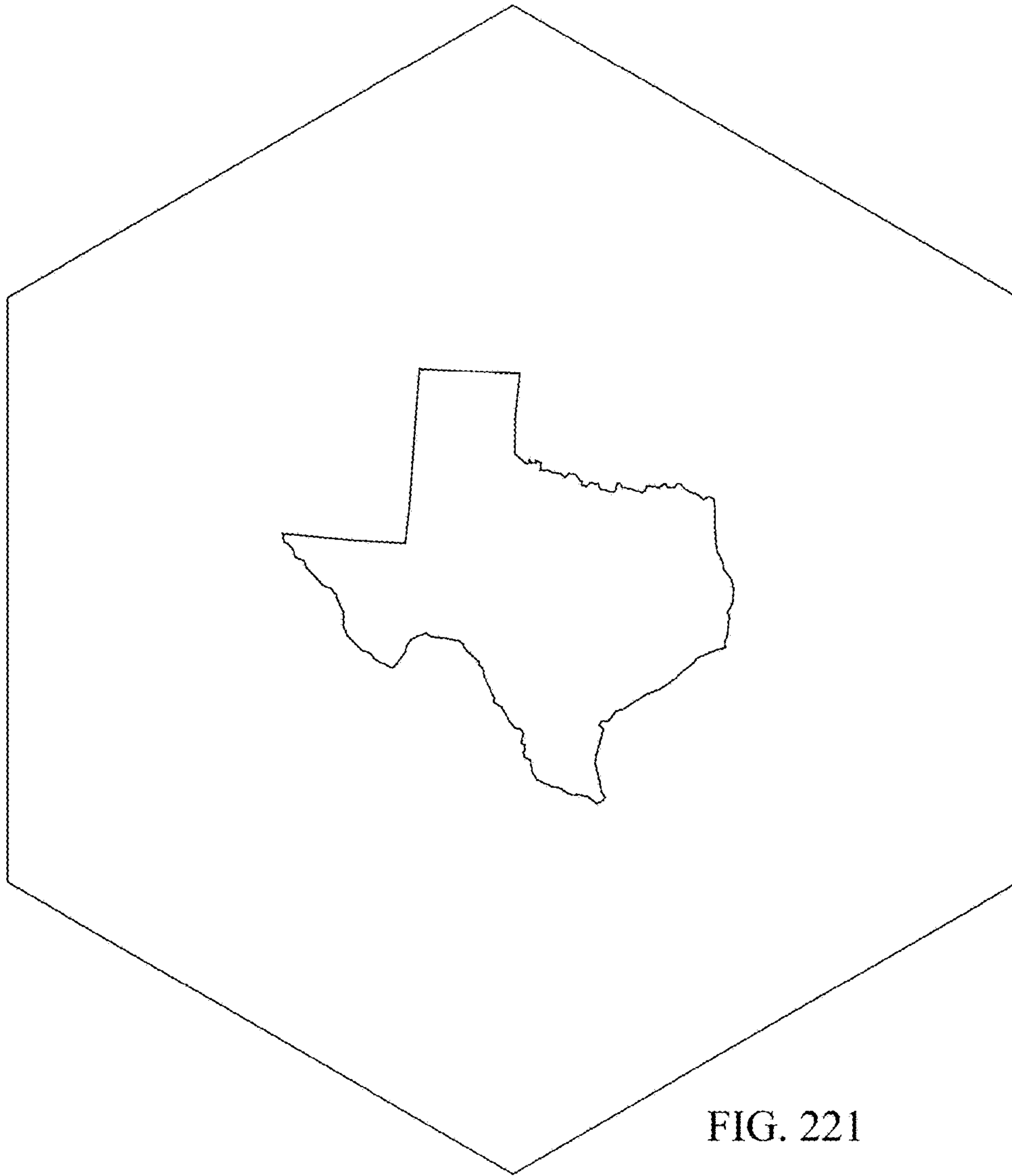

FIG. 221

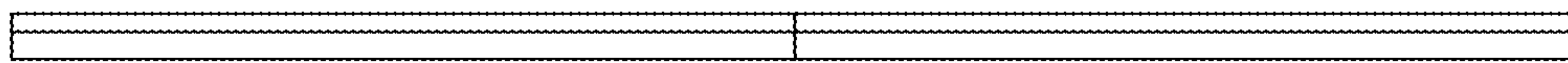

FIG. 222

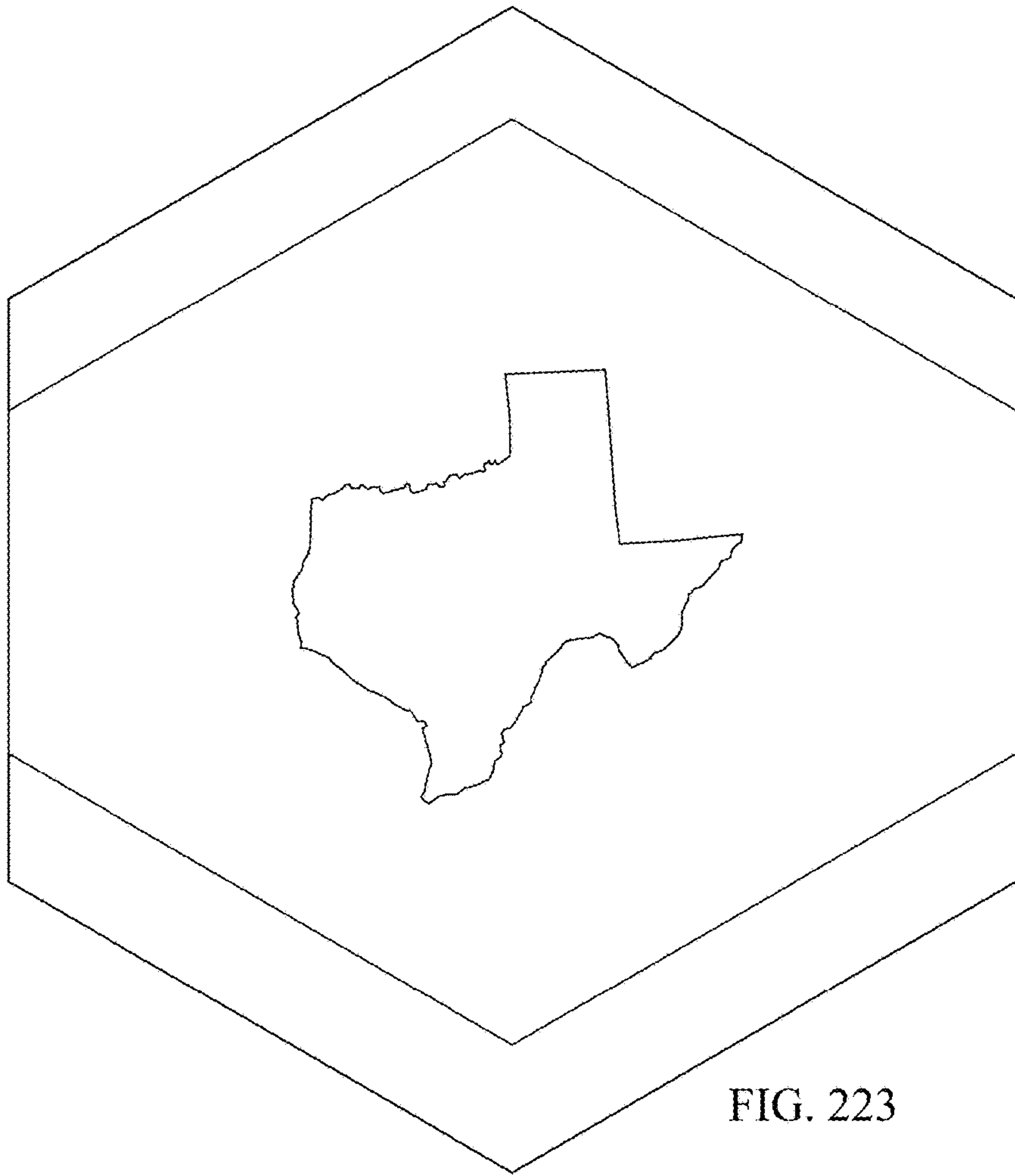

FIG. 223

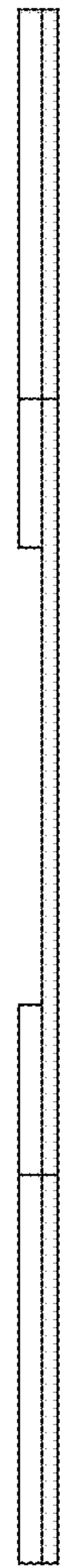

FIG. 224

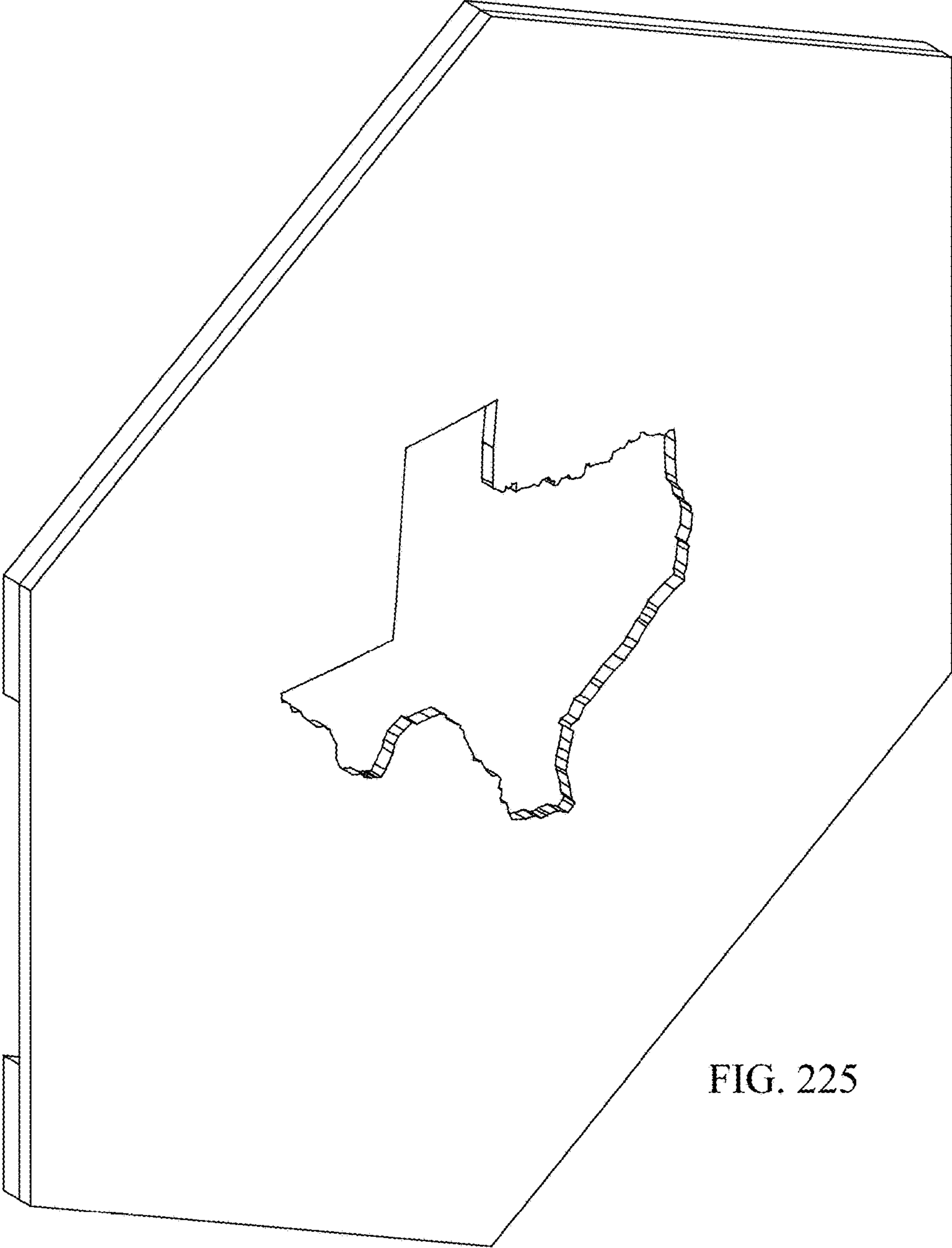

FIG. 225

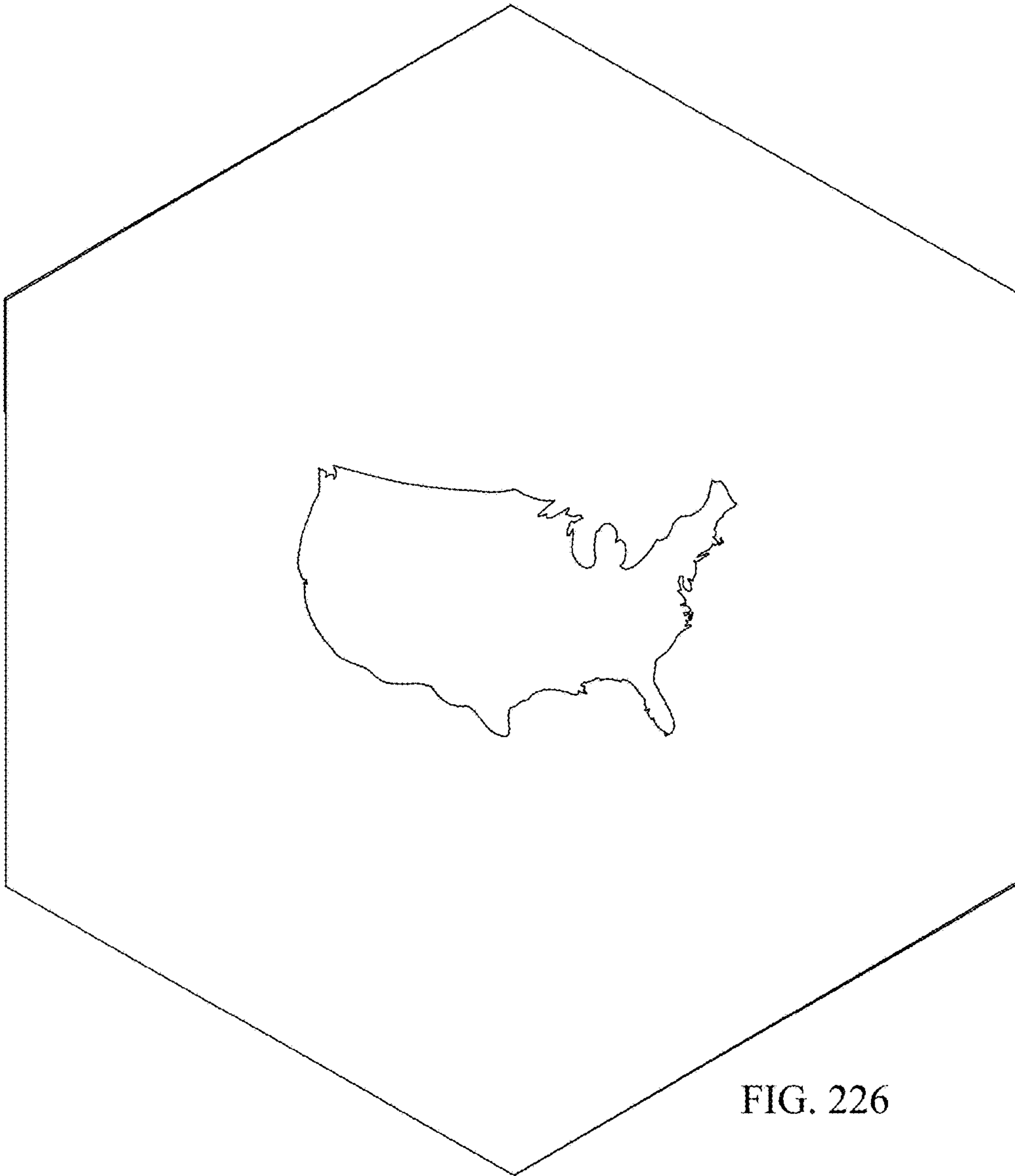

FIG. 226

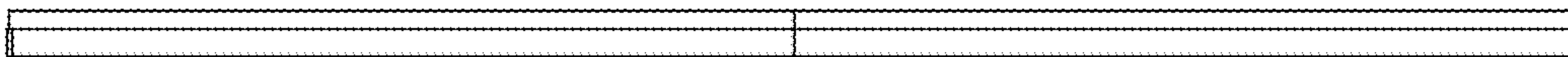

FIG. 227

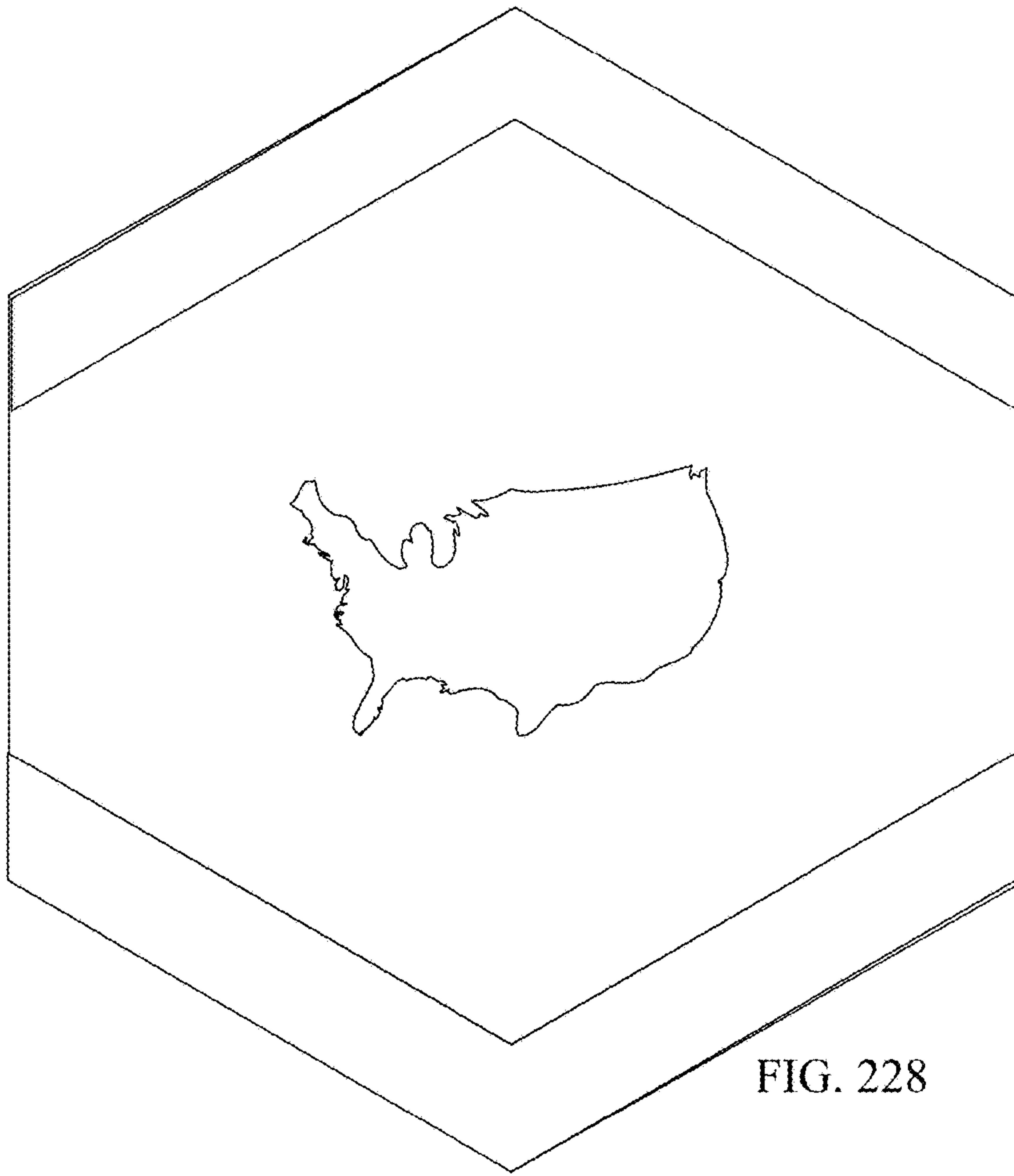

FIG. 228



FIG. 229

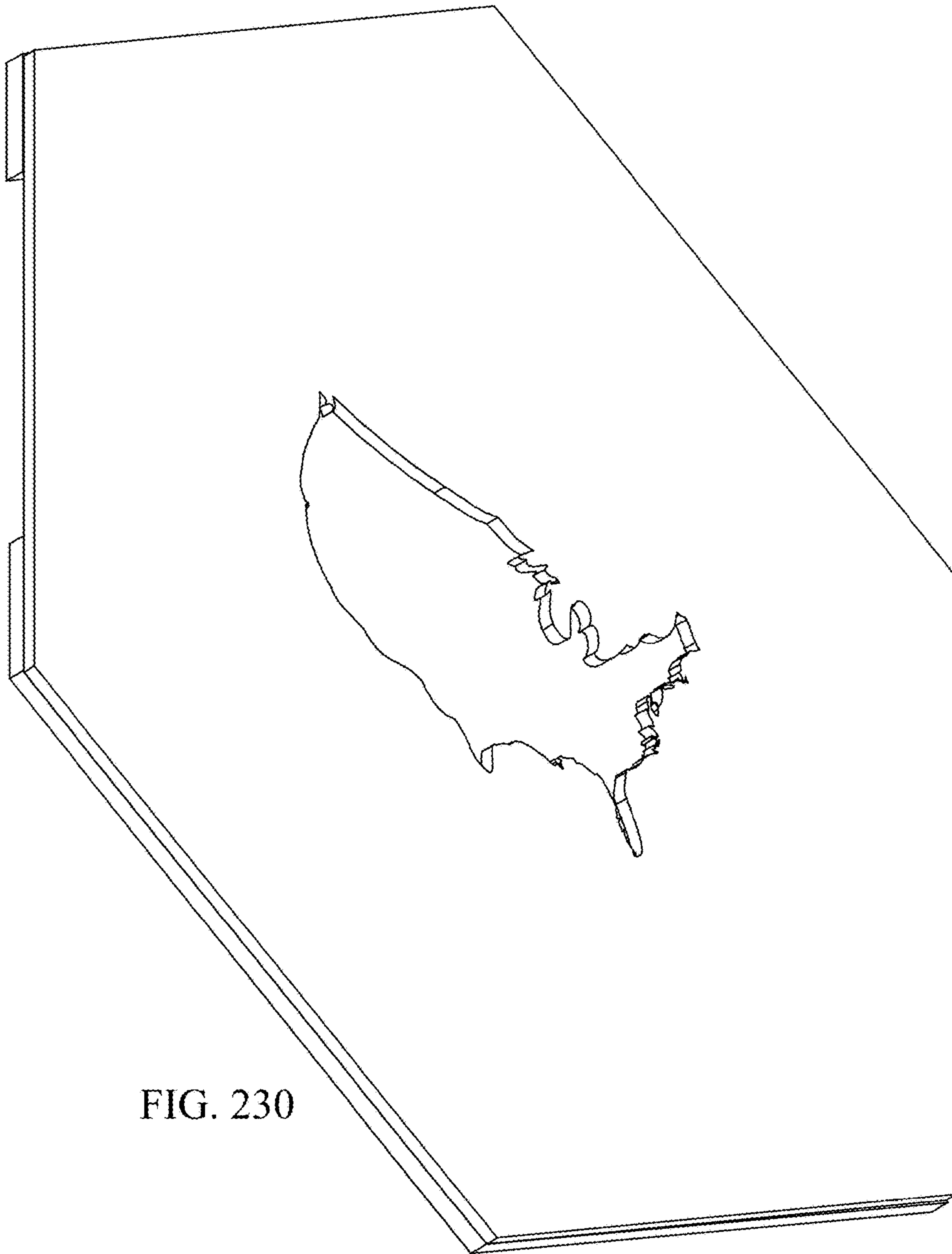

FIG. 230

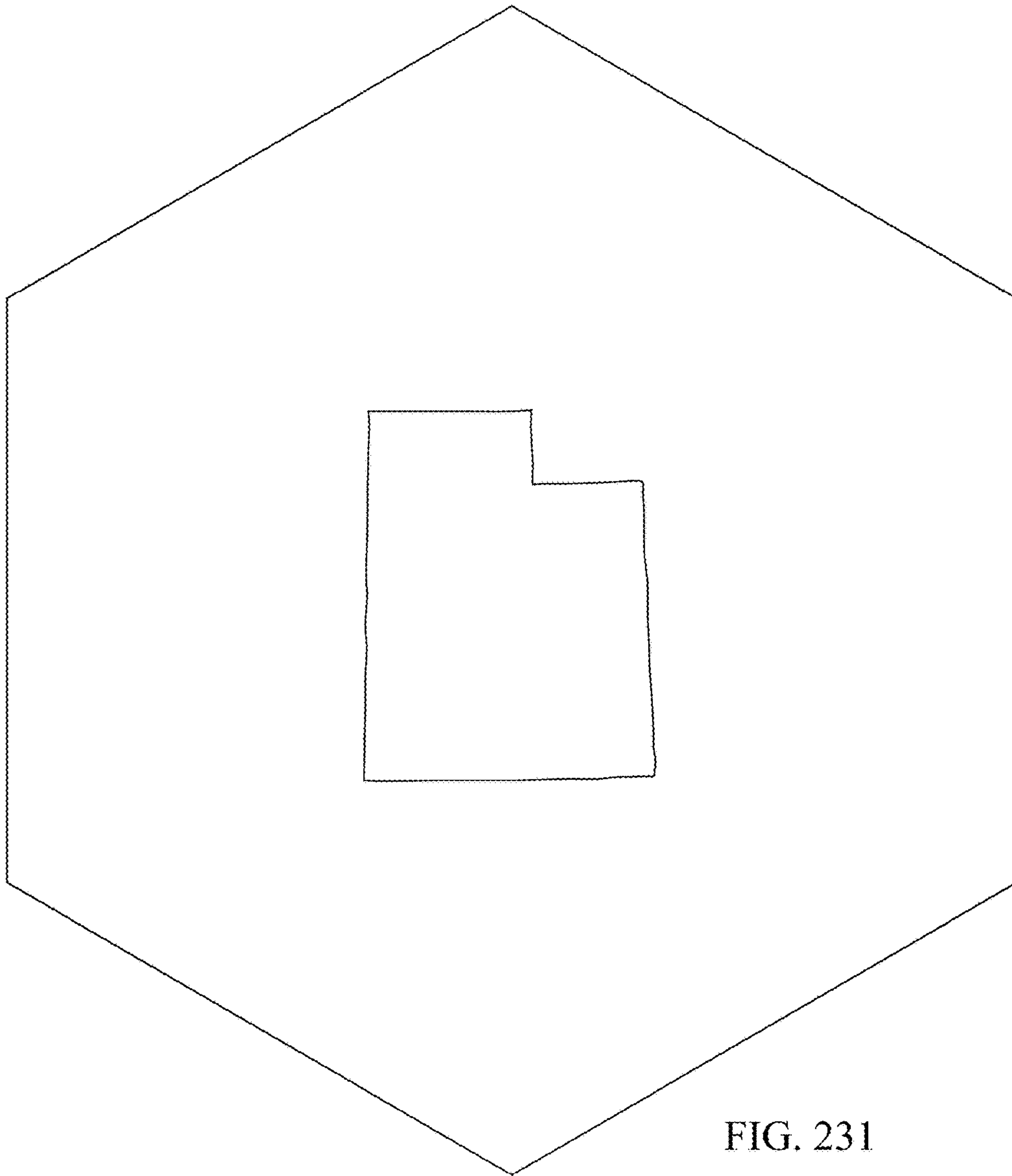

FIG. 231

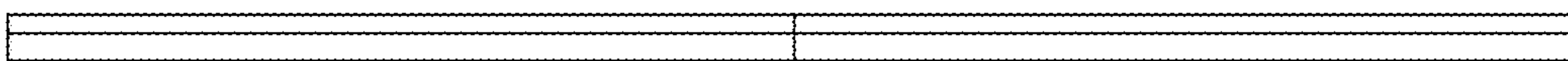

FIG. 232

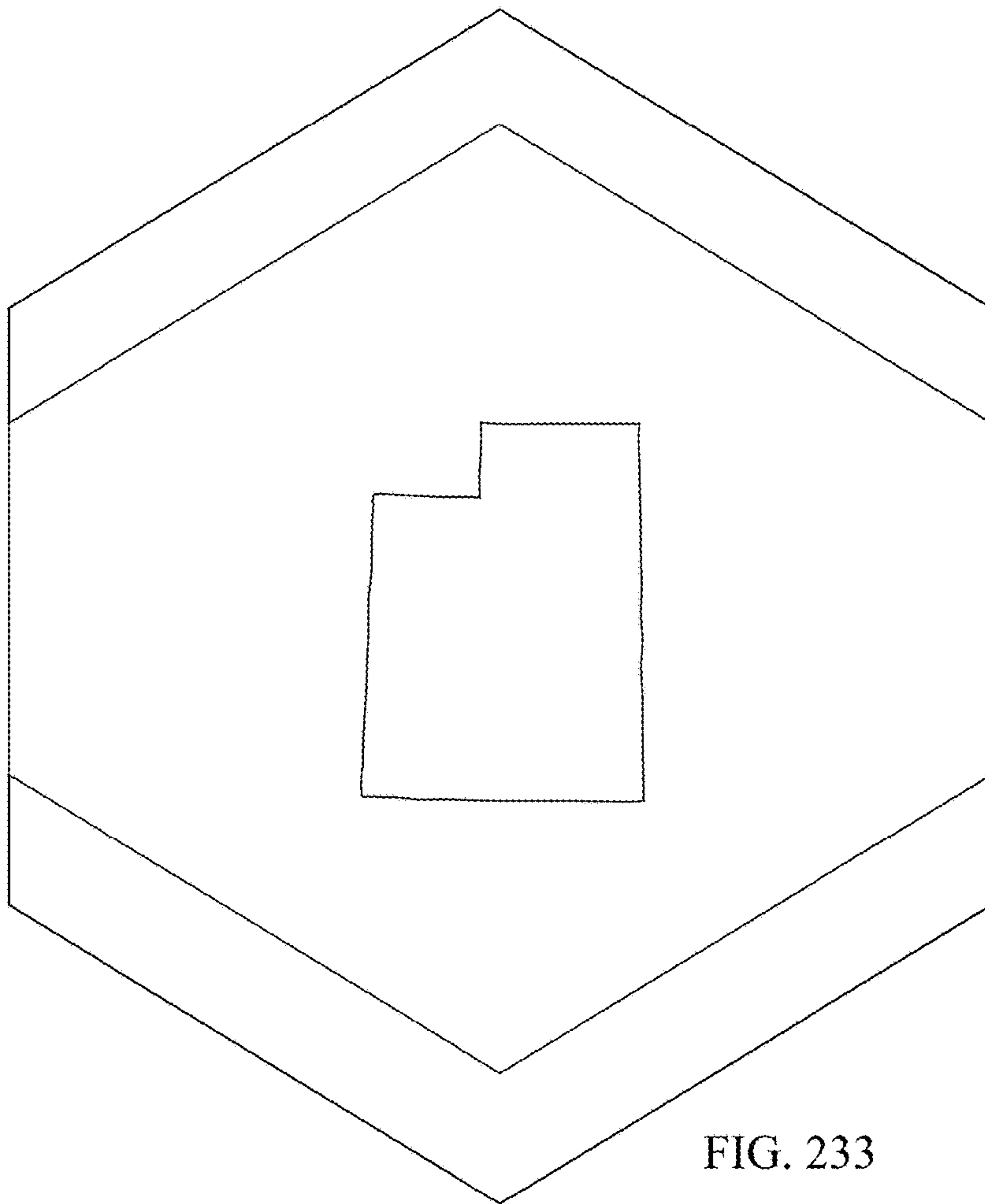

FIG. 233



FIG. 234

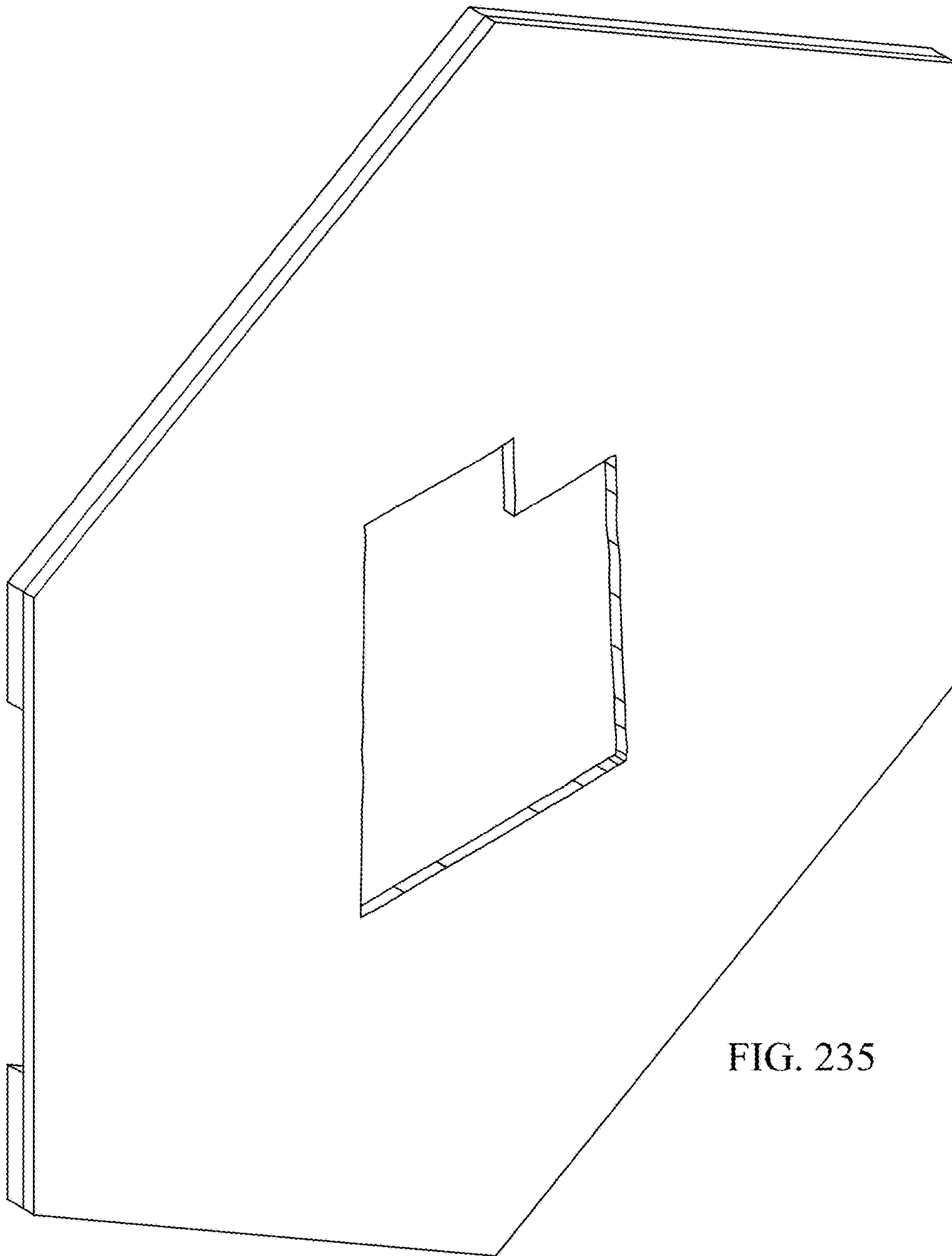

FIG. 235

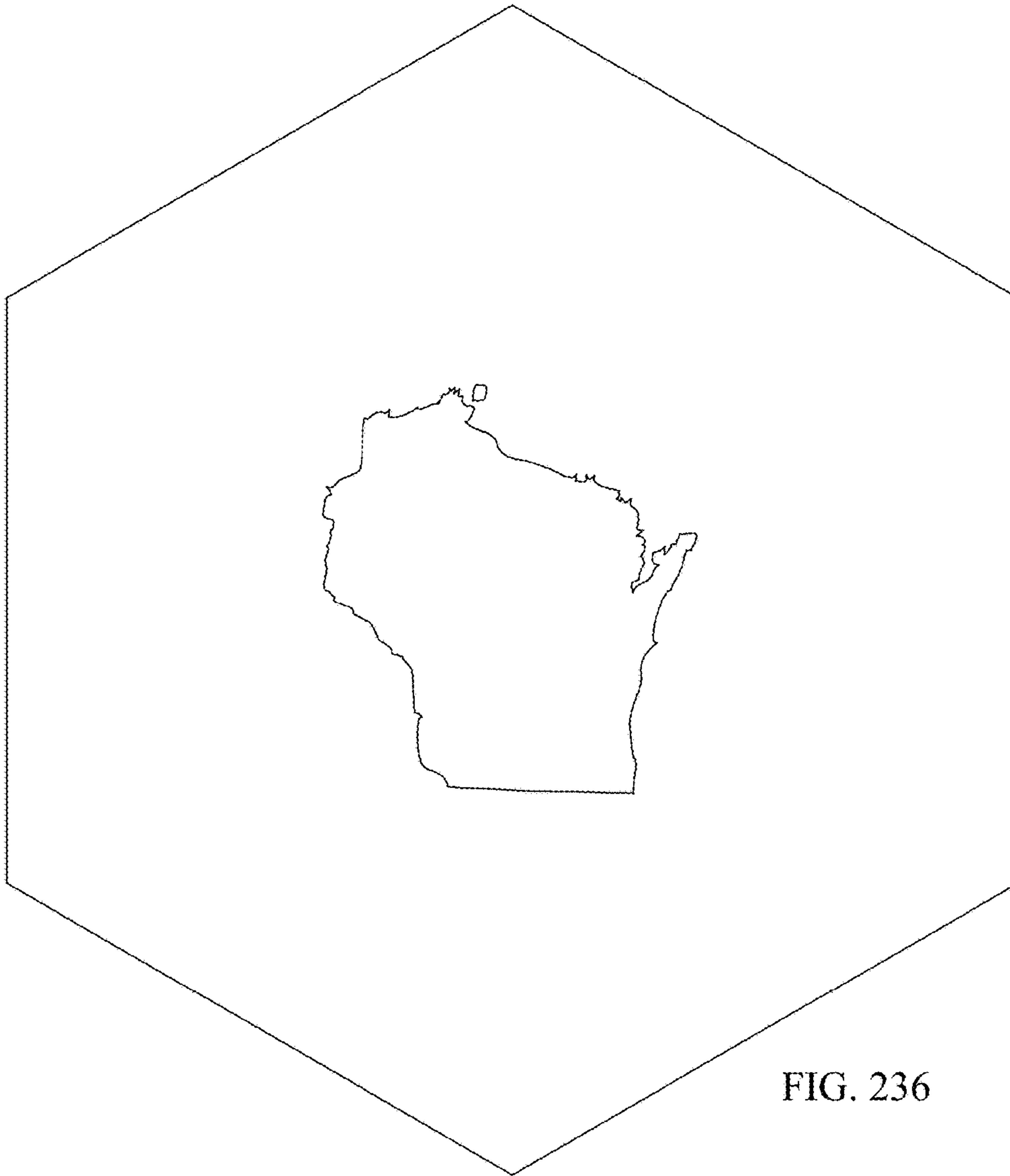

FIG. 236

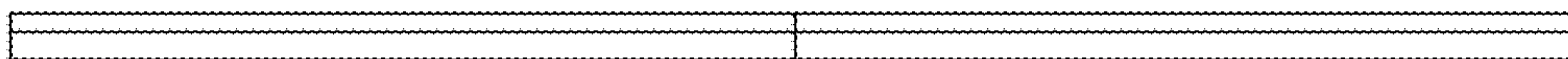

FIG. 237

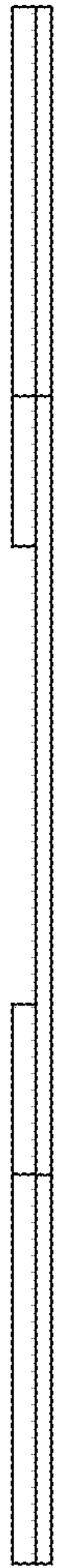

FIG. 238

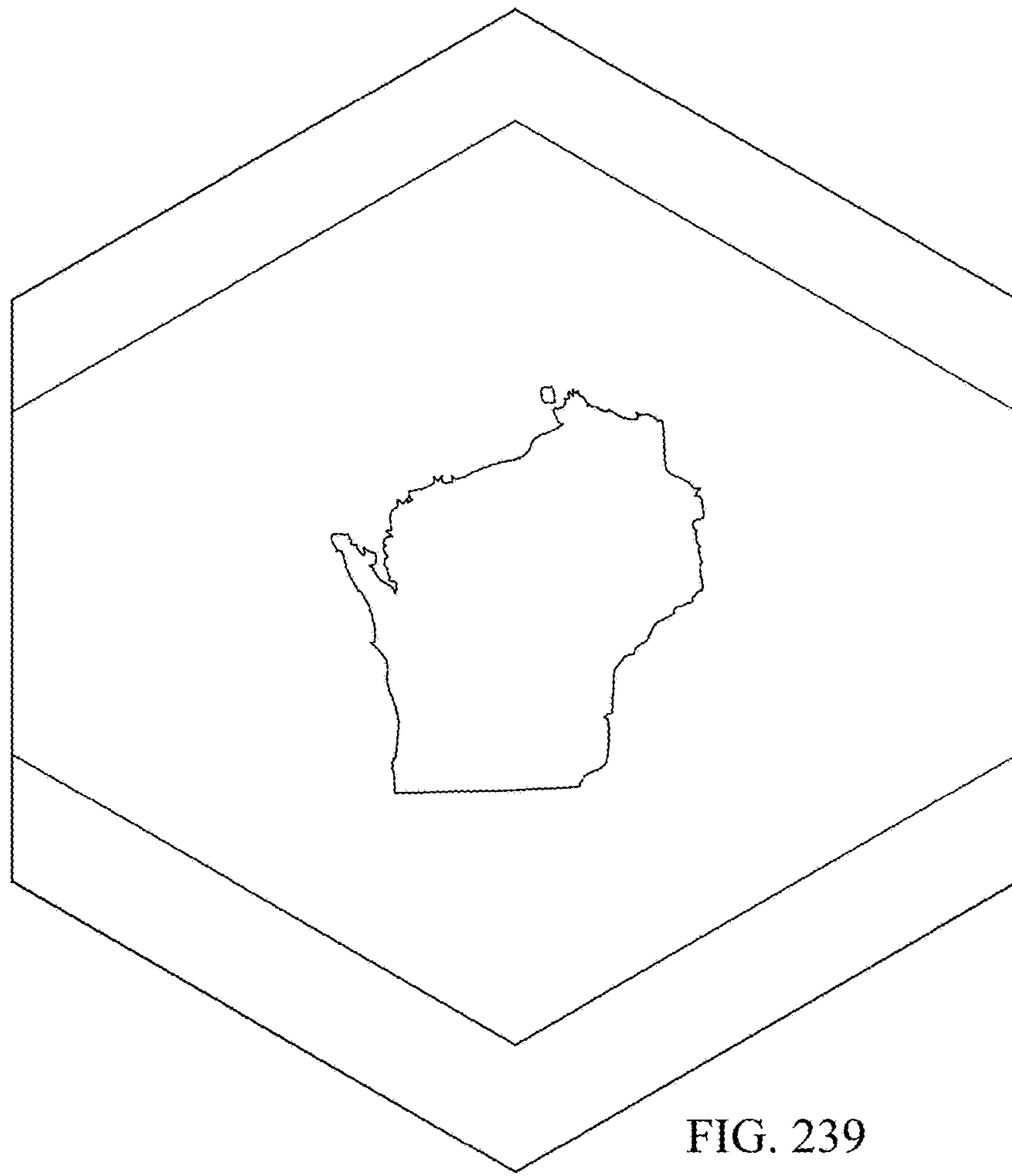

FIG. 239

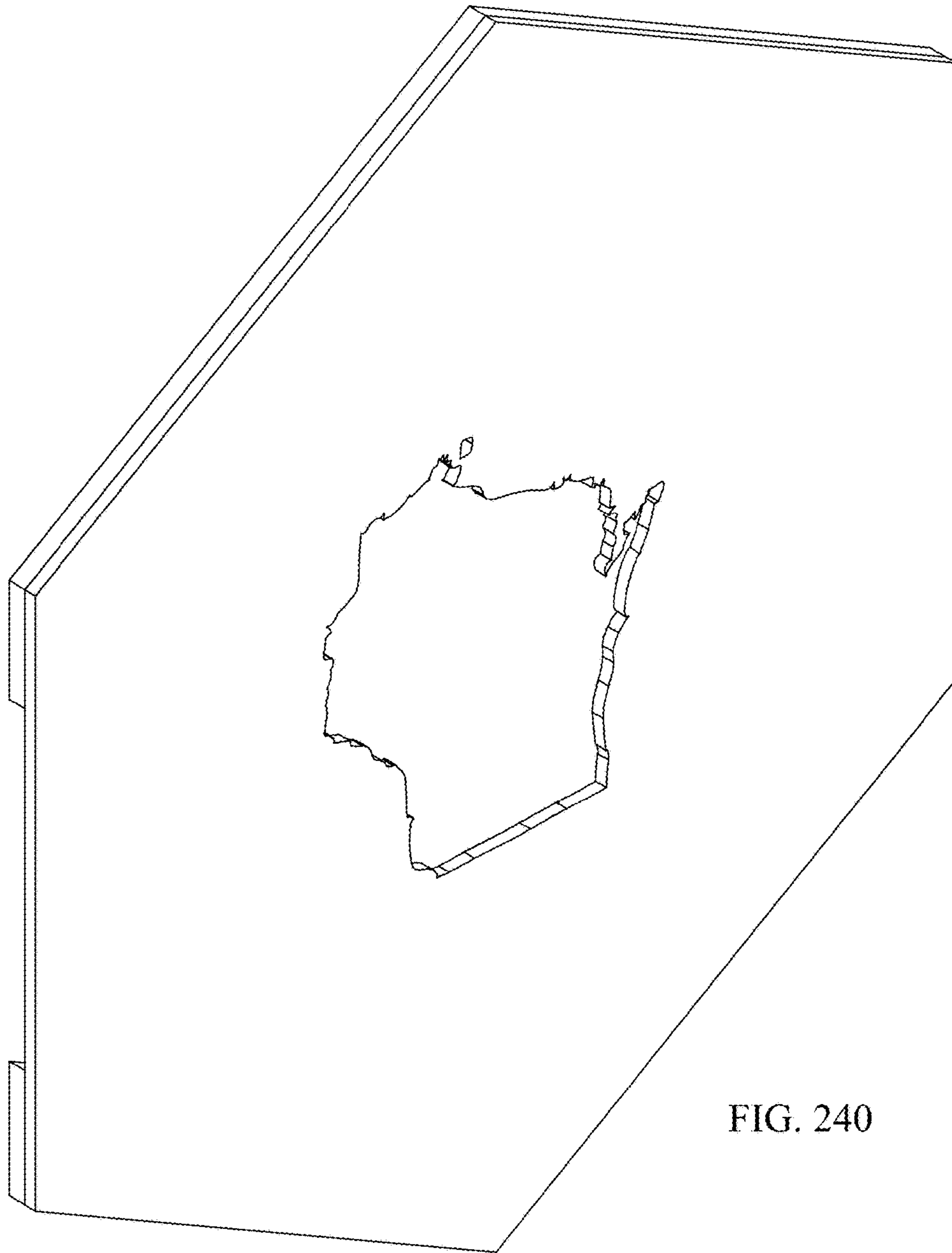

FIG. 240

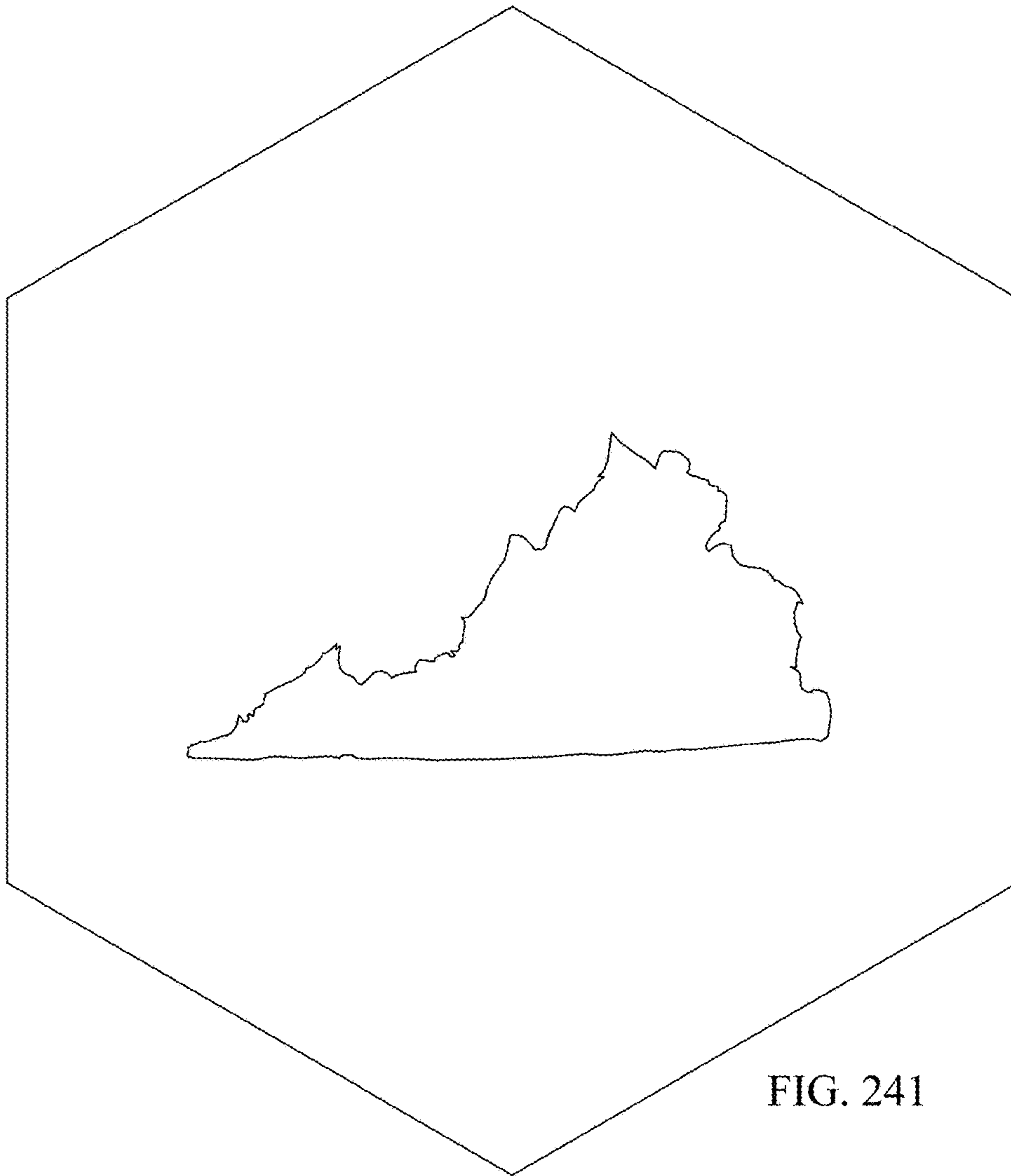

FIG. 241

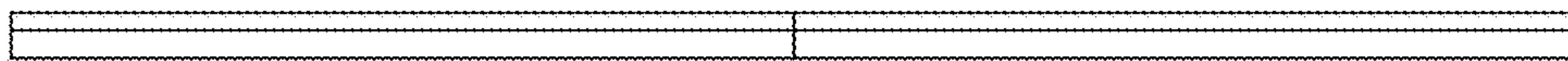

FIG. 242

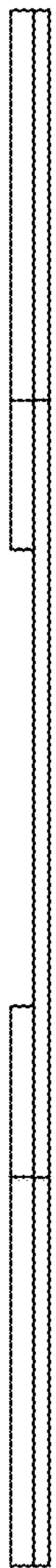

FIG. 243

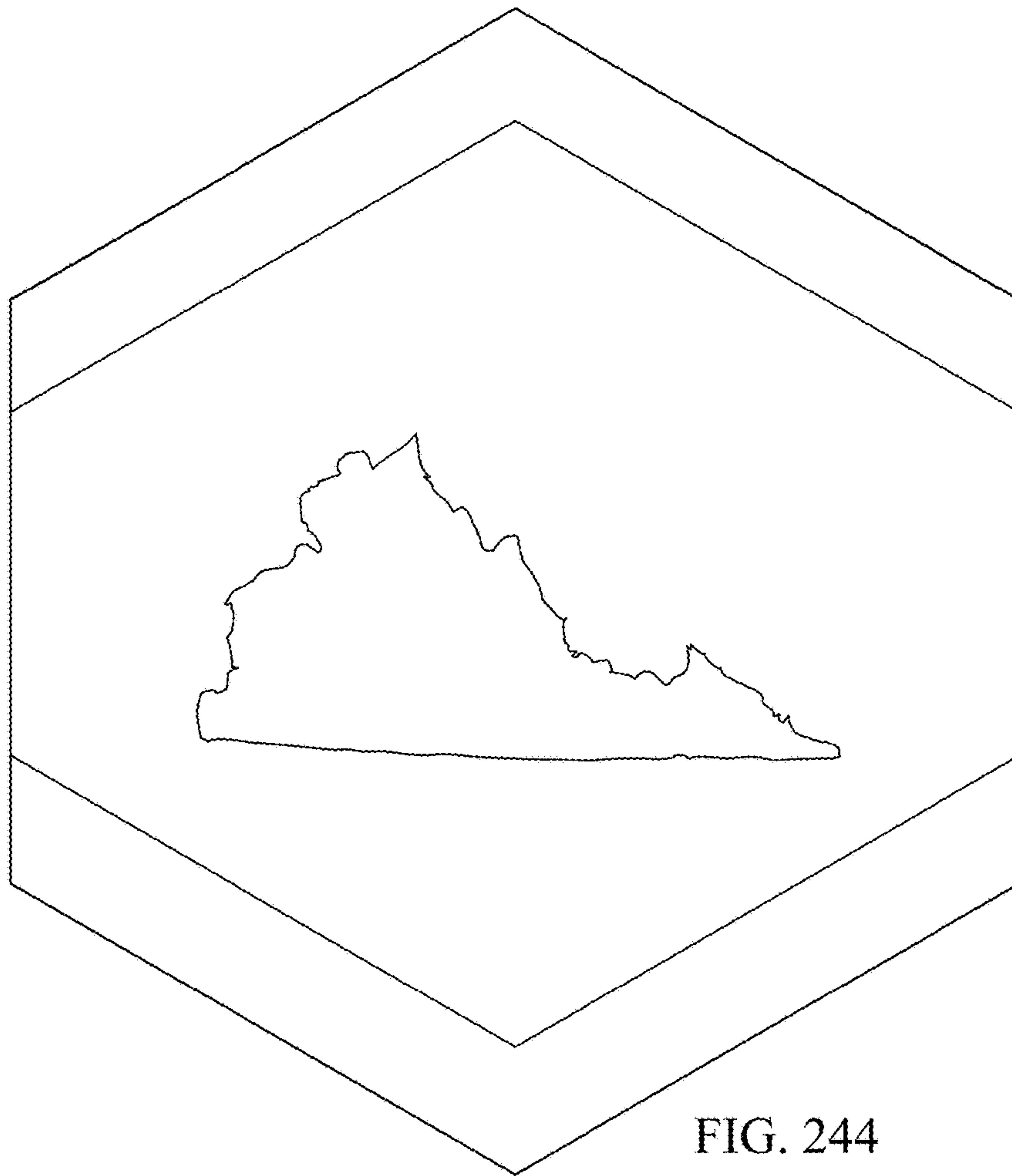

FIG. 244

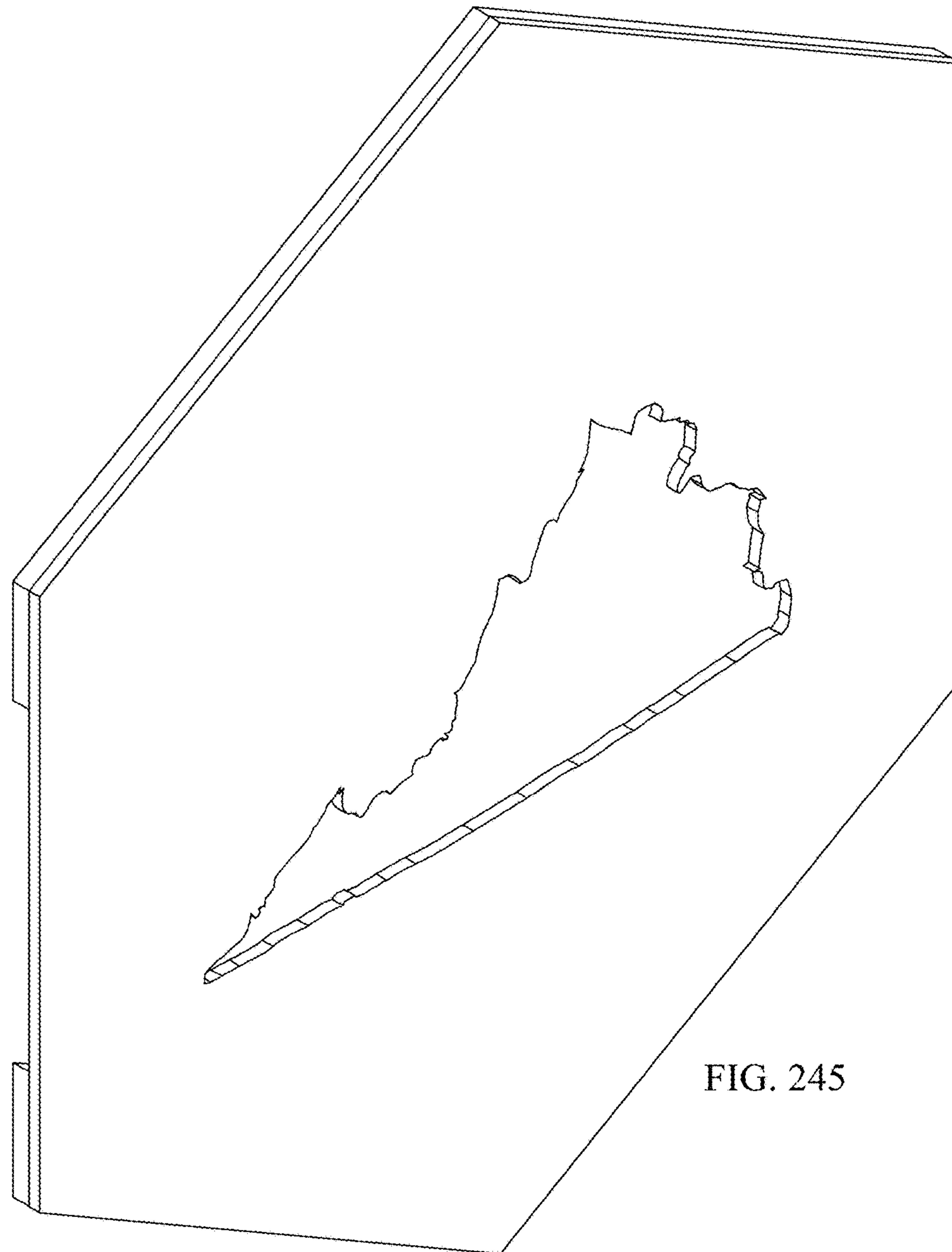

FIG. 245

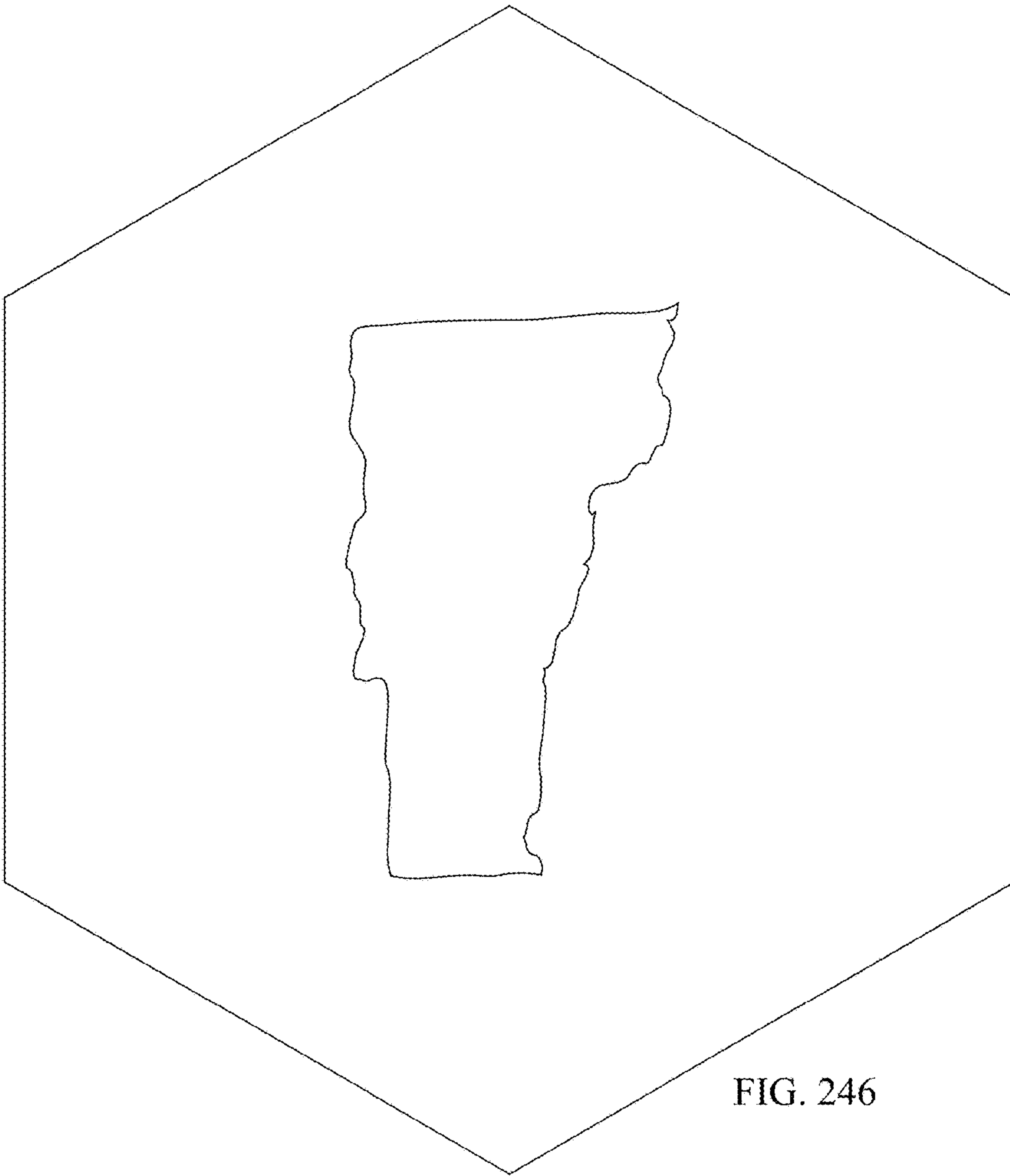

FIG. 246

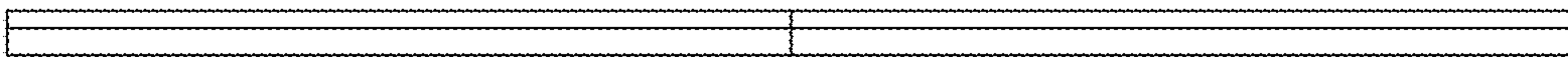

FIG. 247

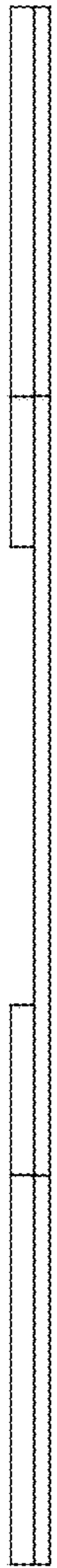

FIG. 248

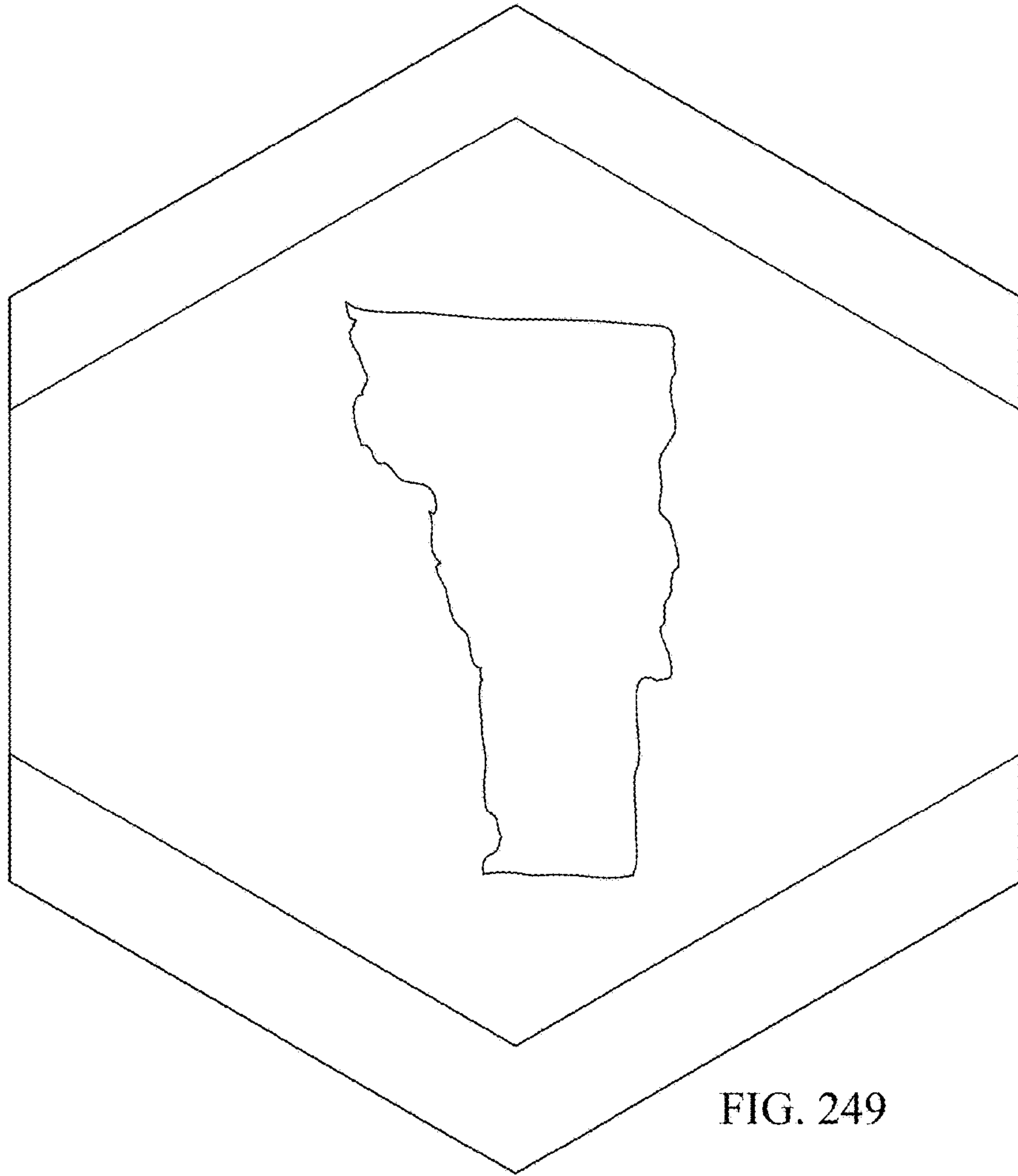

FIG. 249

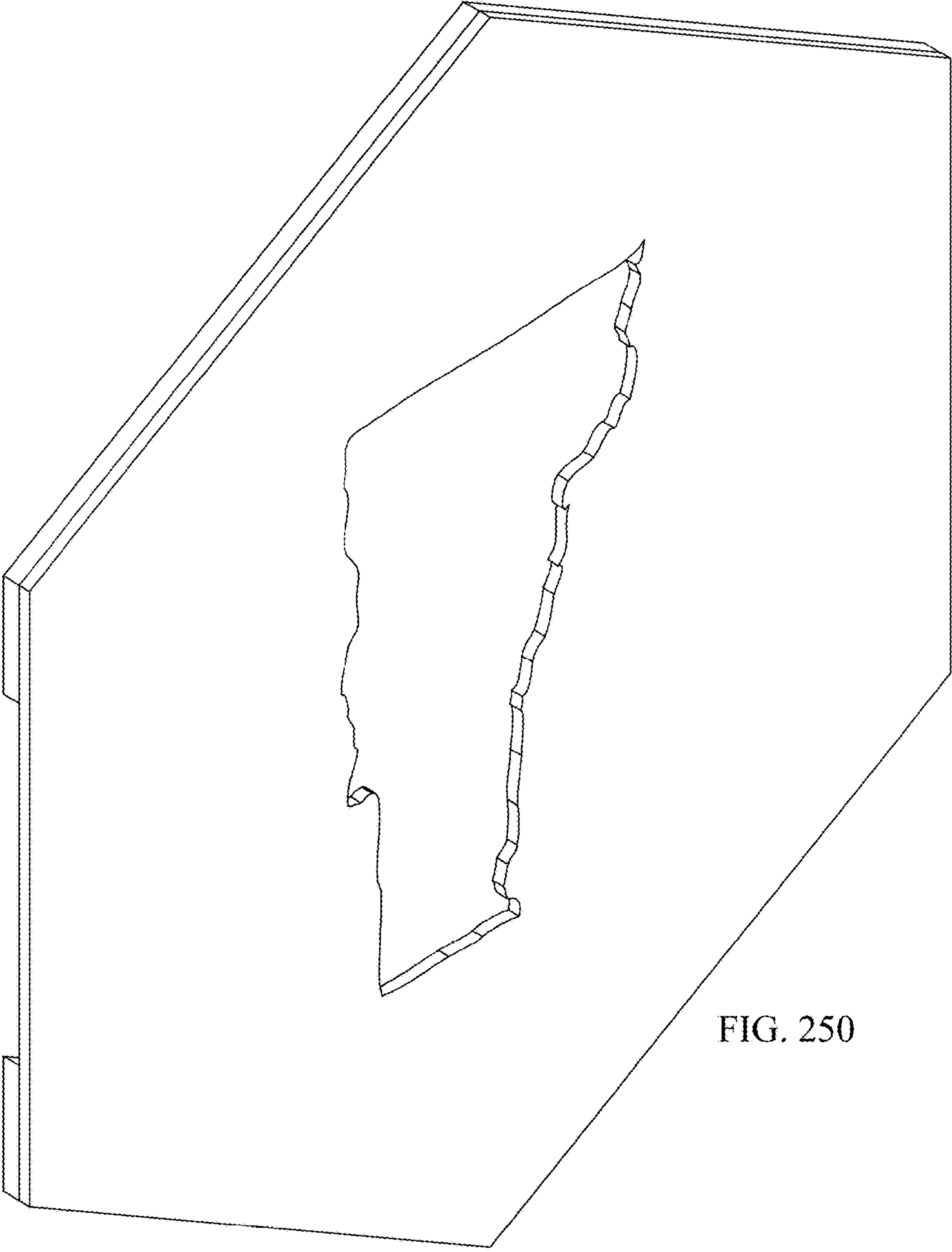

FIG. 250

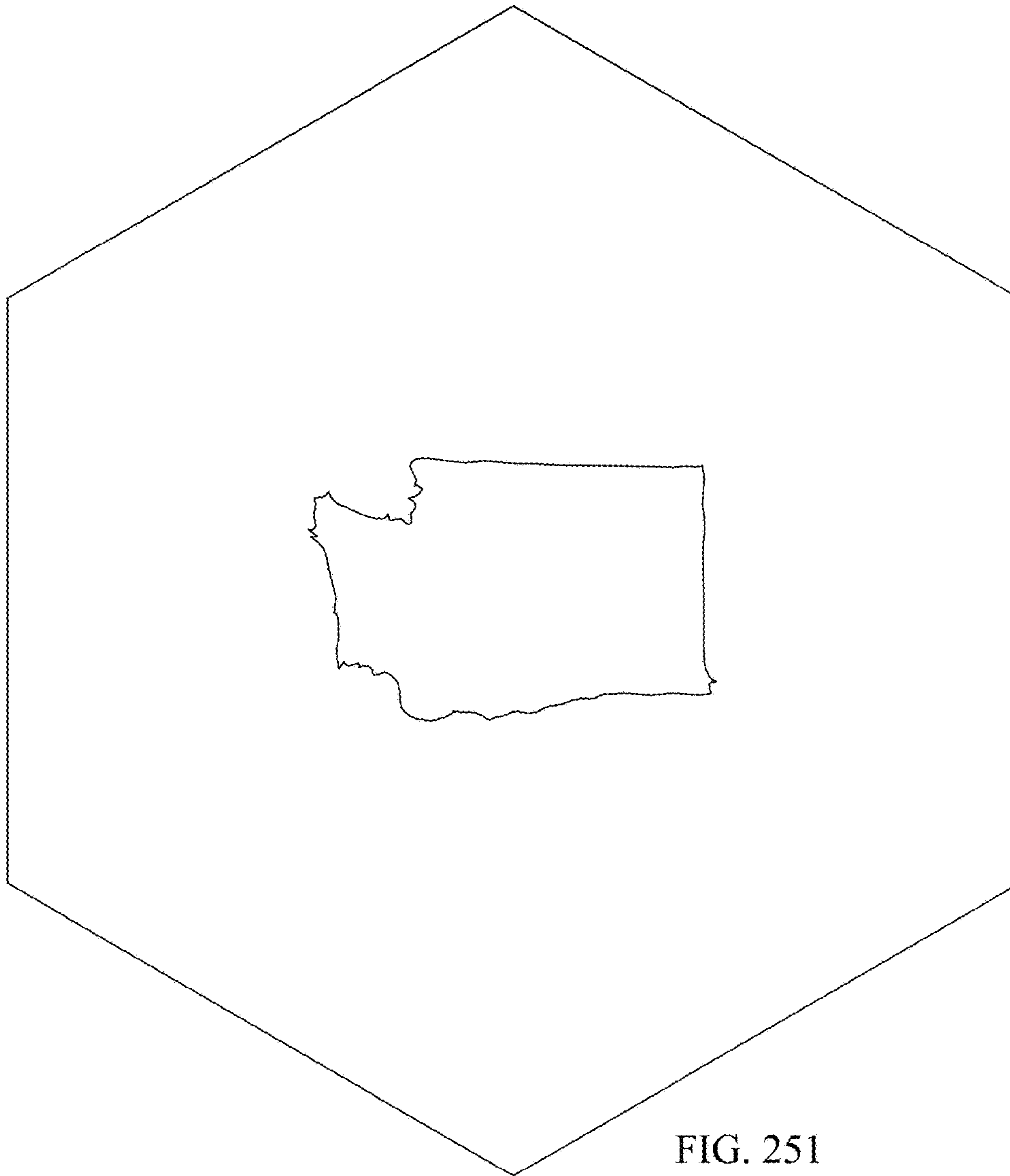

FIG. 251

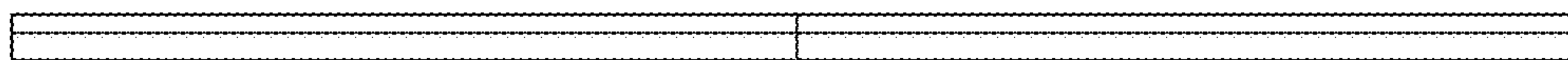

FIG. 252



FIG. 253

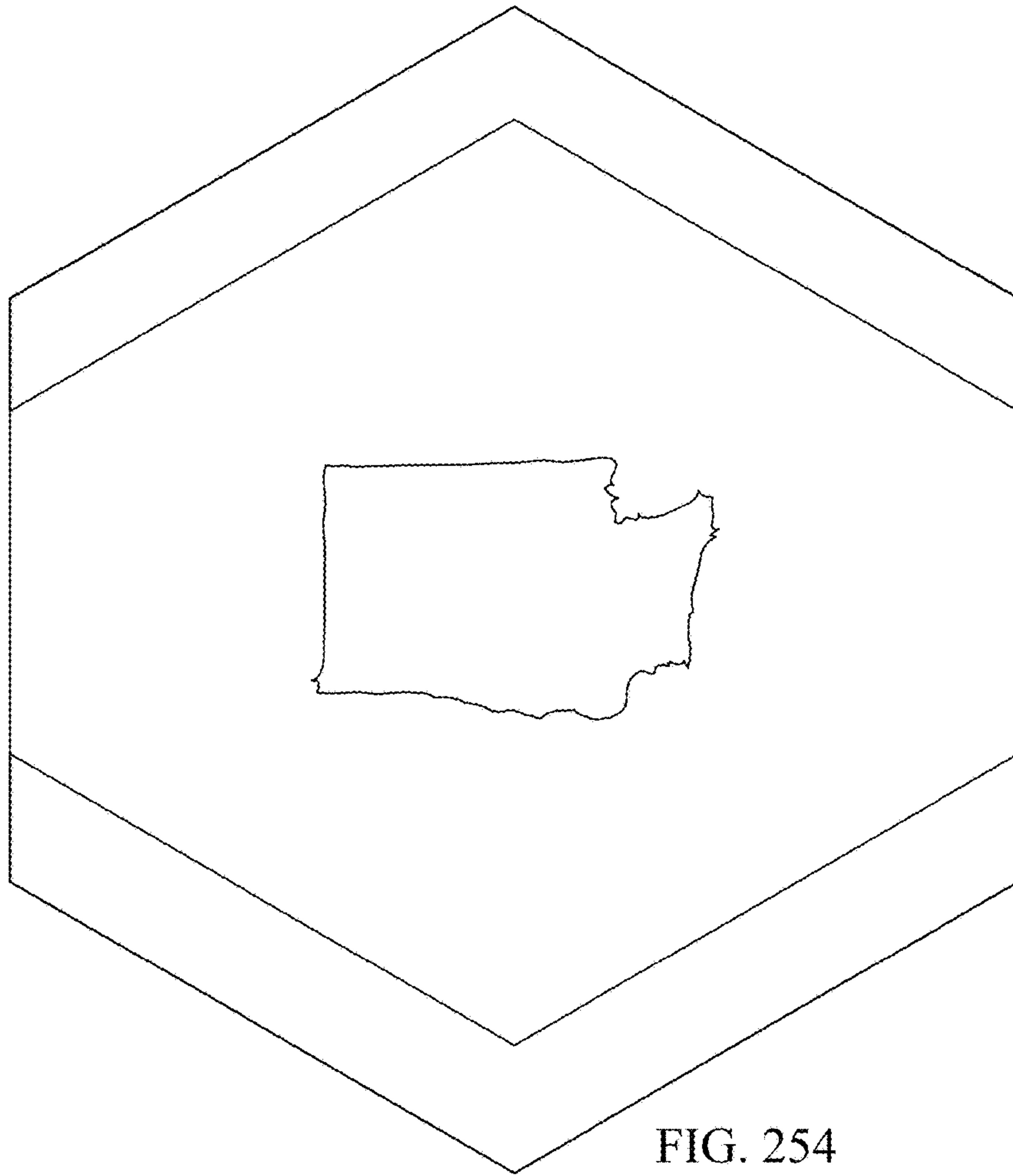

FIG. 254

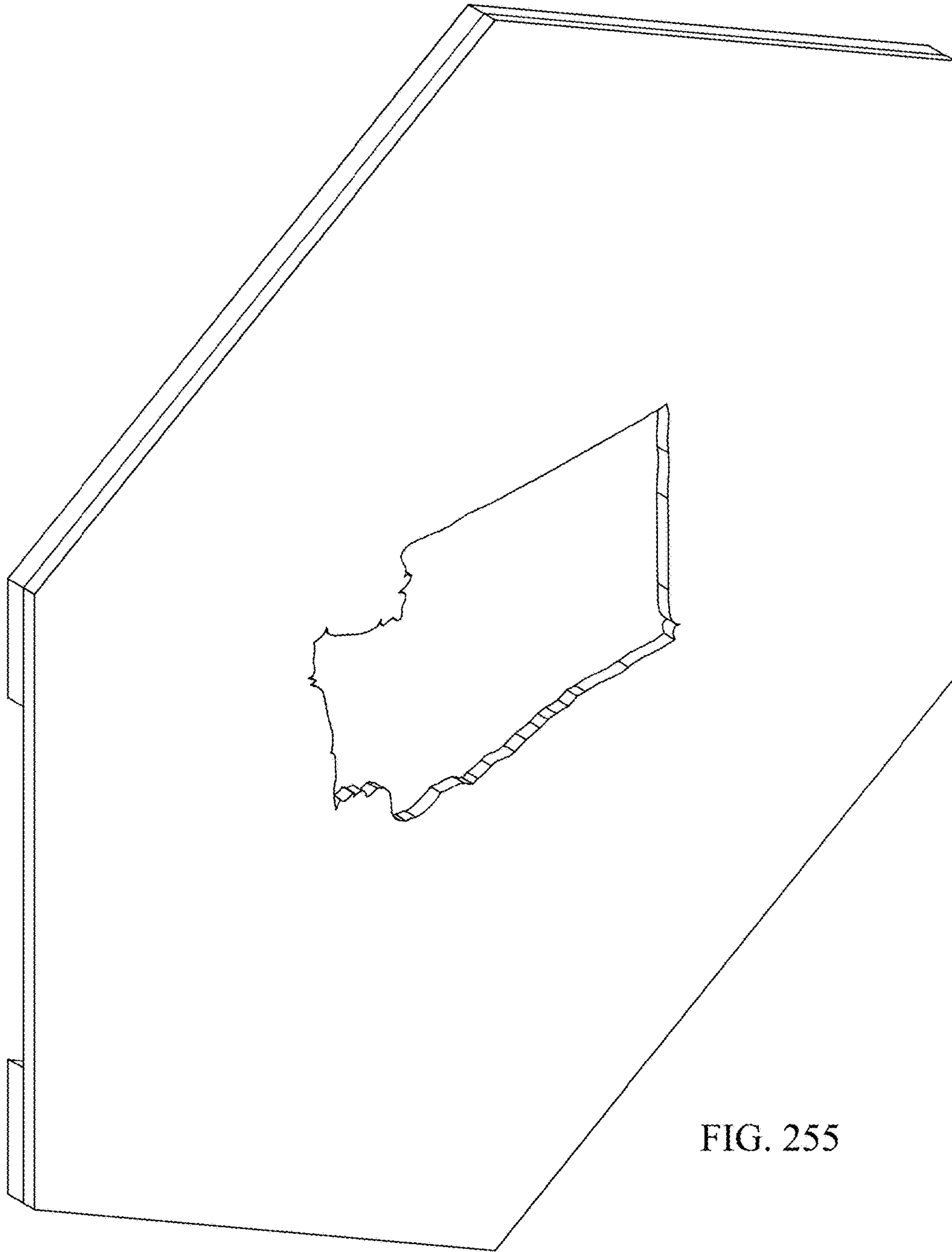

FIG. 255

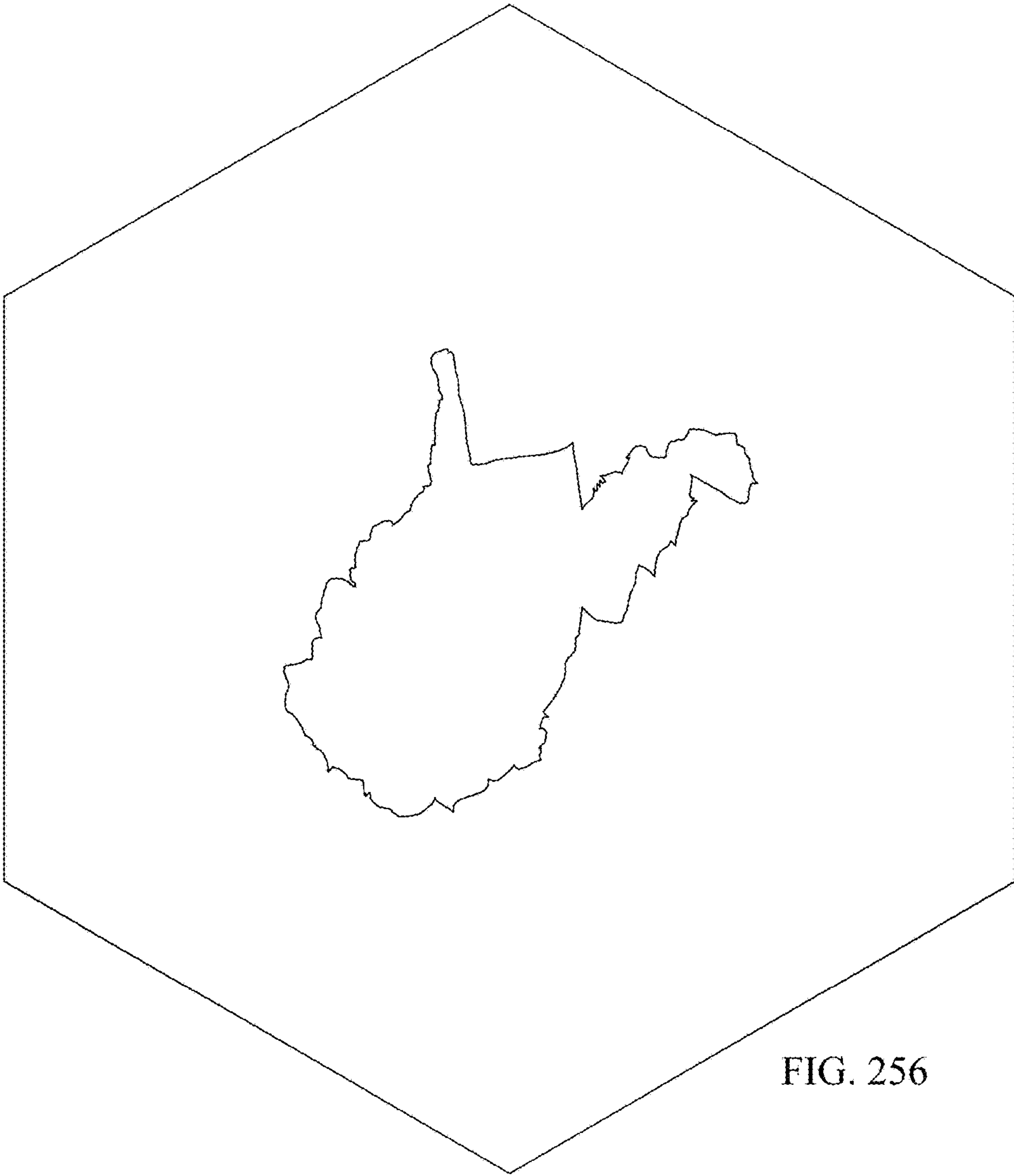

FIG. 256

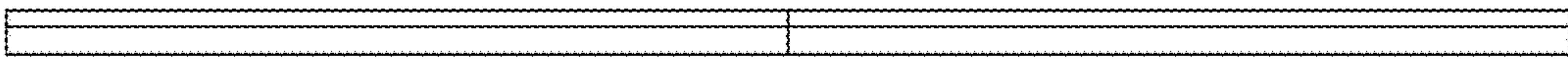

FIG. 257

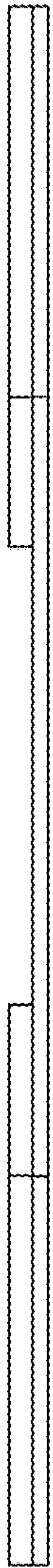

FIG. 258

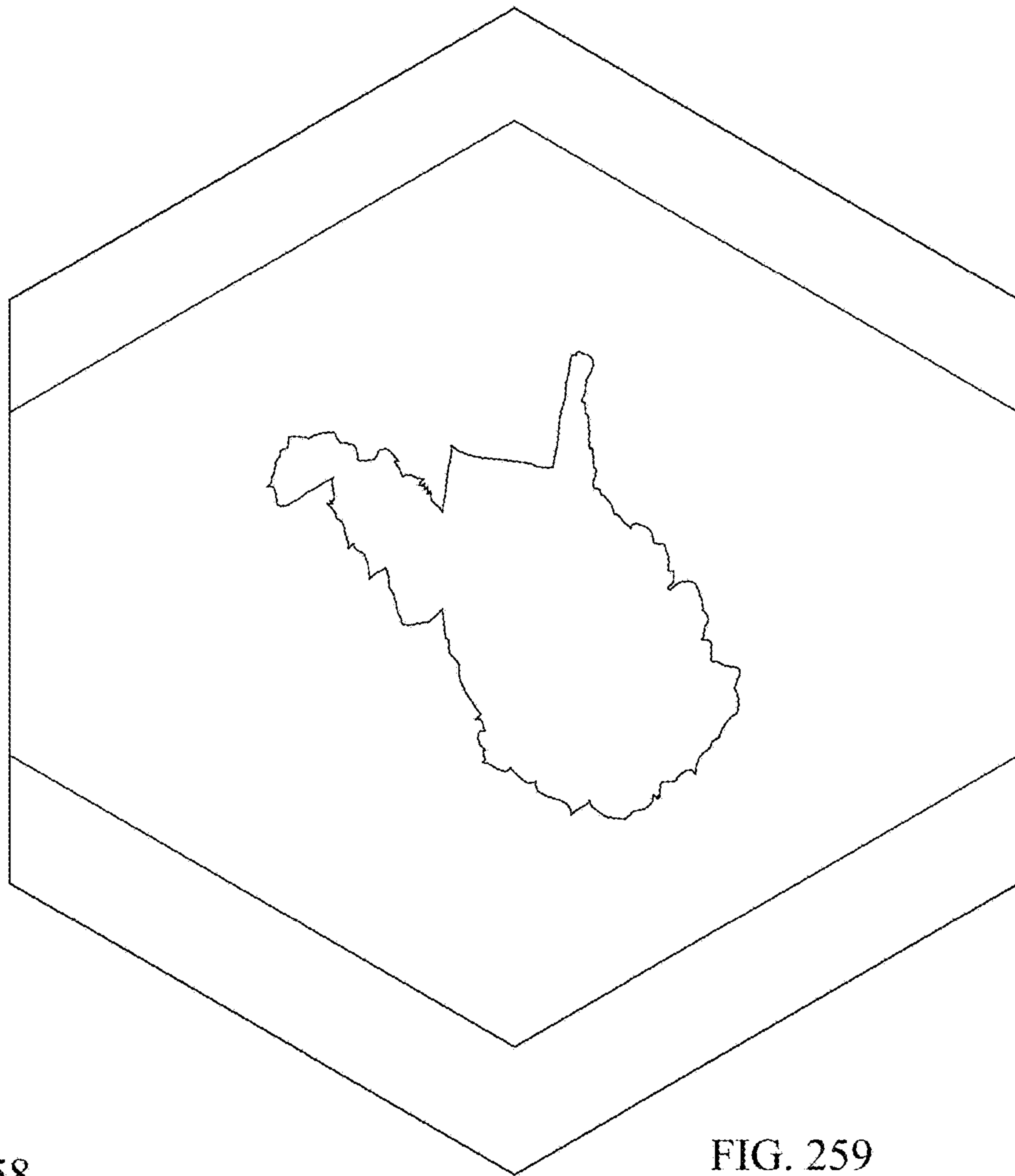

FIG. 259

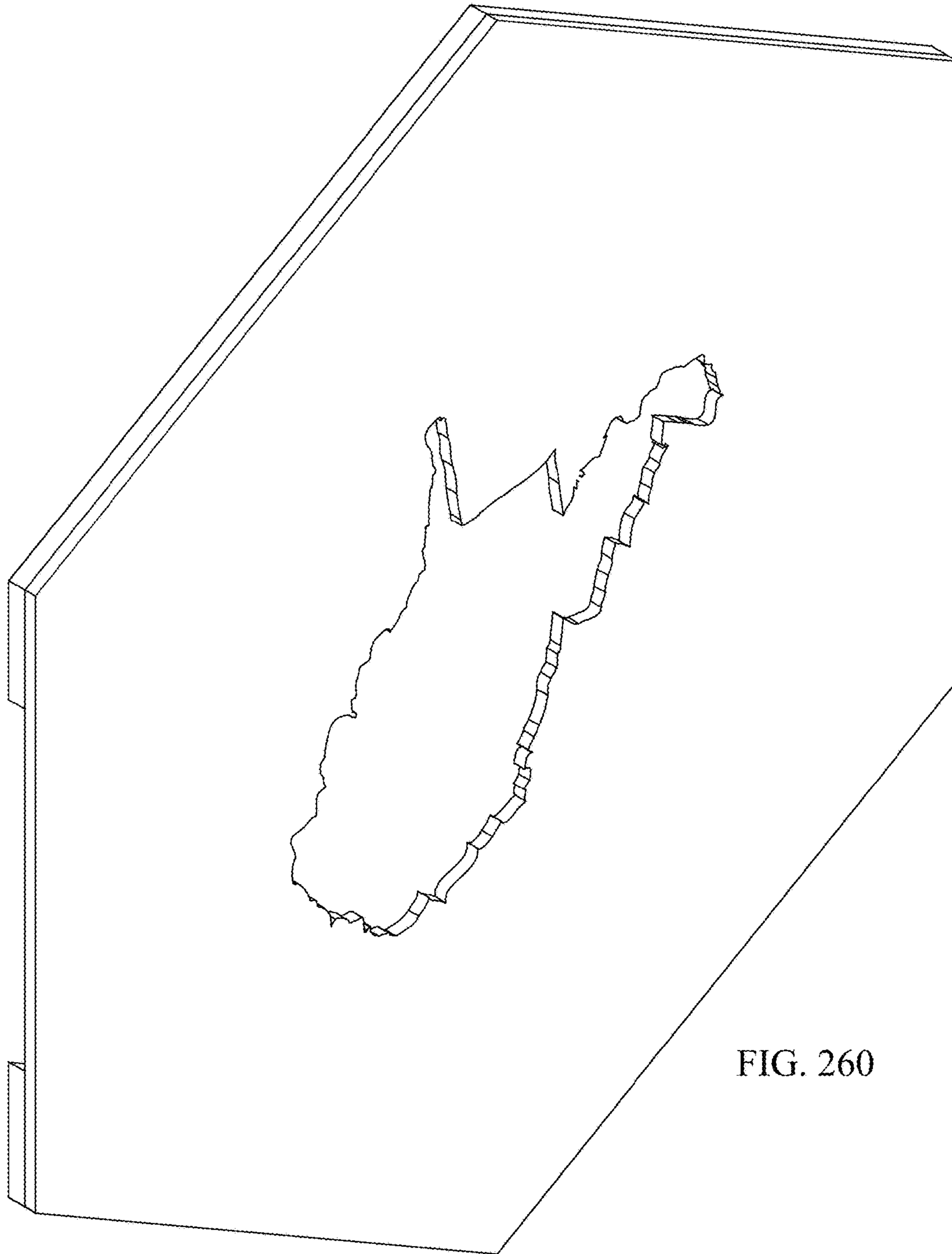

FIG. 260