



US00D824127S

(12) **United States Design Patent** (10) **Patent No.:** **US D824,127 S**
Gooden (45) **Date of Patent:** **** Jul. 24, 2018**

(54) **MICROFIBER DRYING CLOTH**
(71) Applicant: **Hopkins Manufacturing Corporation**,
Emporia, KS (US)
(72) Inventor: **Marcus Gooden**, LomaLinda, CA (US)
(73) Assignee: **Hopkins Manufacturing Corporation**,
Emporia, KS (US)

(**) Term: **15 Years**

(21) Appl. No.: **29/577,812**

(22) Filed: **Sep. 15, 2016**

(51) **LOC (11) Cl.** **07-05**

(52) **U.S. Cl.**
USPC **D32/40**

(58) **Field of Classification Search**
USPC D32/40-43, 46-49; D21/500-505;
D25/117; D8/70, 62; D3/315; D9/702,
D9/711, 713, 730, 734, 426, 432
CPC A47L 13/22; A47L 13/312; B21D 53/76;
A47K 7/03
See application file for complete search history.

(56) **References Cited**

U.S. PATENT DOCUMENTS

D40,728 S * 6/1910 Hirschfeld D9/432
D97,441 S * 11/1935 Scully D9/432
D122,523 S * 9/1940 Schwartzman D9/713
3,477,065 A * 11/1969 Hoover A41B 13/06
2/69.5
D267,700 S * 1/1983 Skarin 206/443
D297,815 S * 9/1988 MacIvergan D9/432
D347,998 S * 6/1994 Steenwinkel D9/702
D470,704 S * 2/2003 Varon D6/608
D510,195 S * 10/2005 Adams D6/608
D573,075 S * 7/2008 Eskandry D12/203
D609,420 S * 2/2010 Lafortezza D32/40
D618,558 S * 6/2010 Taskinen D9/702
D632,855 S * 2/2011 Quinlan D32/40
D634,905 S * 3/2011 Adams D32/40

D640,567 S * 6/2011 Cluett D9/715
D685,544 S * 7/2013 Clarke D32/40
D685,551 S * 7/2013 Myers D32/40
D688,017 S * 8/2013 Uchiyama D32/40
D693,971 S * 11/2013 Daugherty D30/158
D712,106 S * 8/2014 Corso D32/40
D742,249 S * 11/2015 Farmer D9/713

(Continued)

FOREIGN PATENT DOCUMENTS

WO WO D071876-008 * 6/2009

OTHER PUBLICATIONS

Hopkins Aftermarket Catalog 2014, <http://www.hopkinsmfg.com/aftermarket-interactive-catalog-2014/files/assets/basic-html/pa...>, site visited Jul. 8, 2017.*

(Continued)

Primary Examiner — John Windmuller
Assistant Examiner — John R Yeh
(74) *Attorney, Agent, or Firm* — Bond Schoeneck & King, PLLC; George McGuire

(57) **CLAIM**

The ornamental design for a microfiber drying cloth, as shown and described.

DESCRIPTION

FIG. 1 is a perspective view for my design for packaged microfiber drying cloths;
FIG. 2 is a top plan view thereof;
FIG. 3 is a bottom plan view thereof;
FIG. 4 is a right side elevation view thereof;
FIG. 5 is a left side elevation view thereof;
FIG. 6 is a front elevation view thereof; and,
FIG. 7 is a rear elevation view thereof.
The cloths are rectangular with rounded corners, individually folded and contained by the packaging.

1 Claim, 6 Drawing Sheets

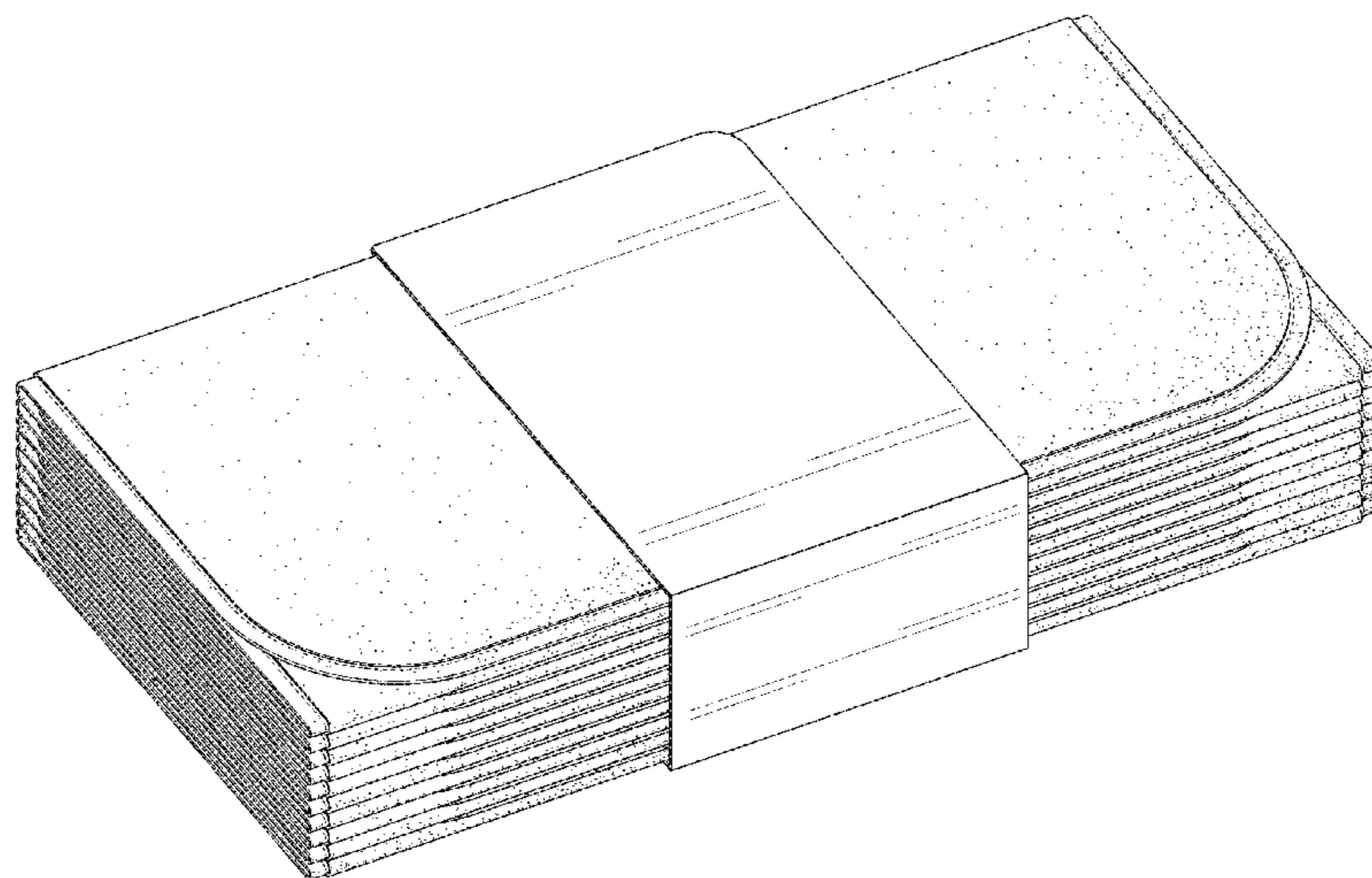

(56)

References Cited

U.S. PATENT DOCUMENTS

D744,852 S * 12/2015 Lee D9/702
D779,142 S * 2/2017 Baldwin D32/40
D786,670 S * 5/2017 Lin D9/432

OTHER PUBLICATIONS

Zwipes website. Yellow Microfiber Cleaning Cloths, date unknown,
<http://zwipes.com/product/yellow-microfiber-cleaning-cloths-48pk/>, site visited Jul. 8, 2017.*

* cited by examiner

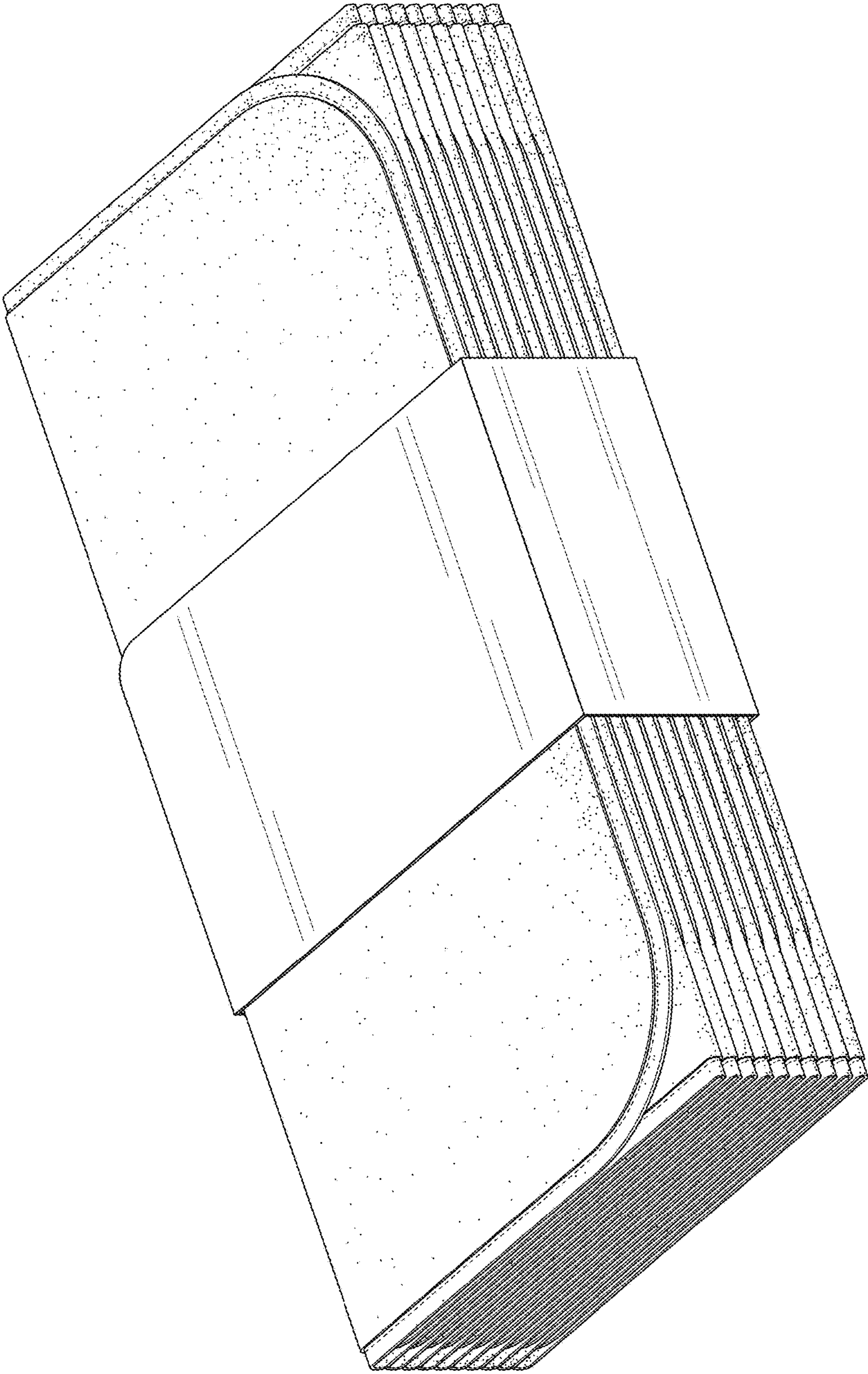

FIG. 1

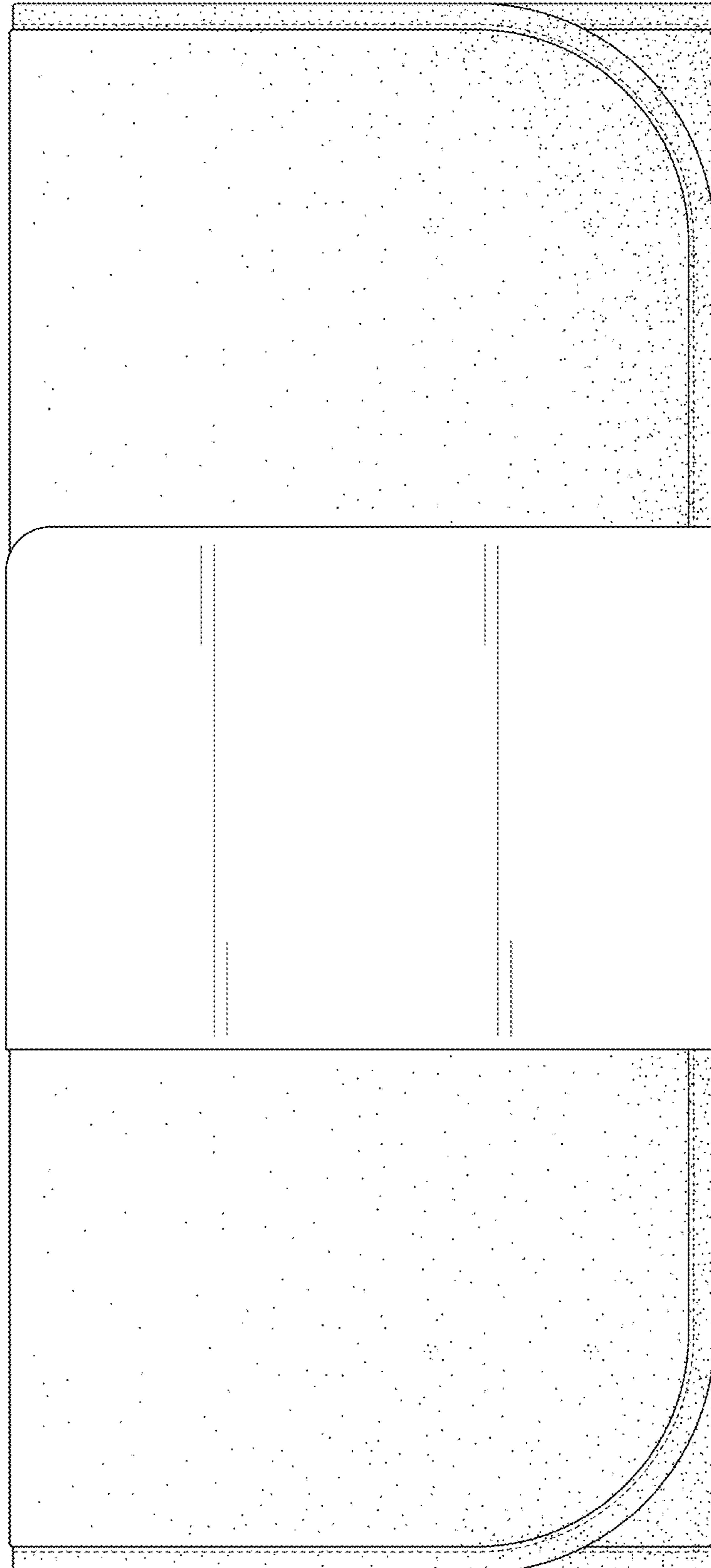

FIG. 2

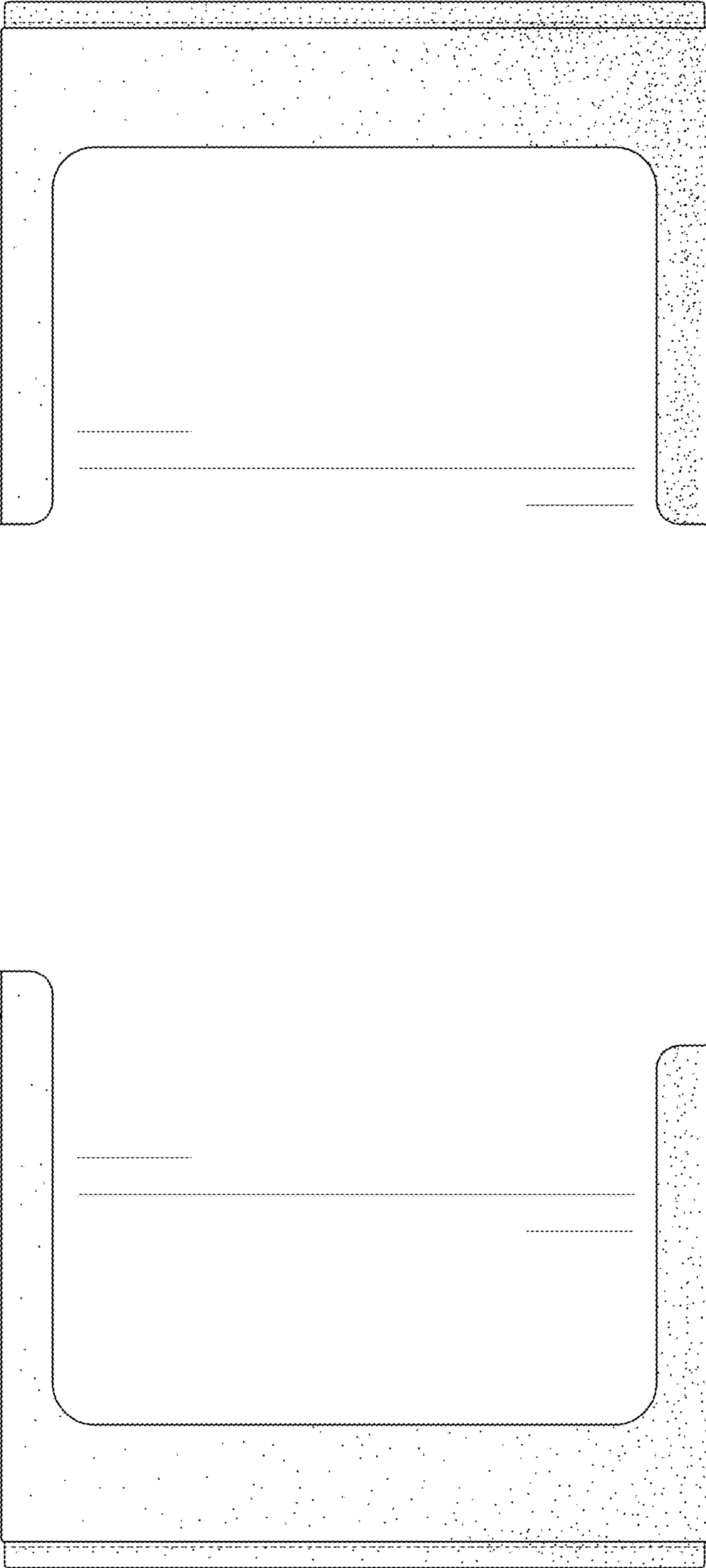

FIG. 3

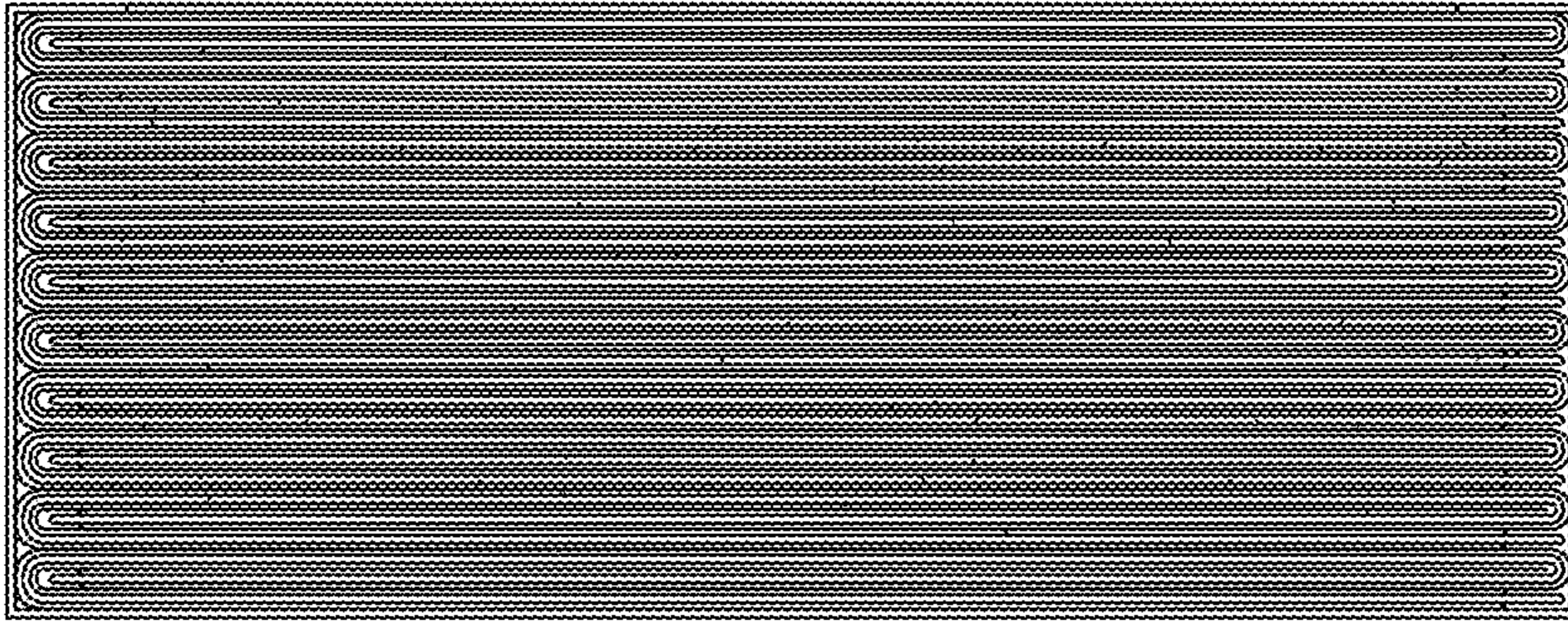

FIG. 5

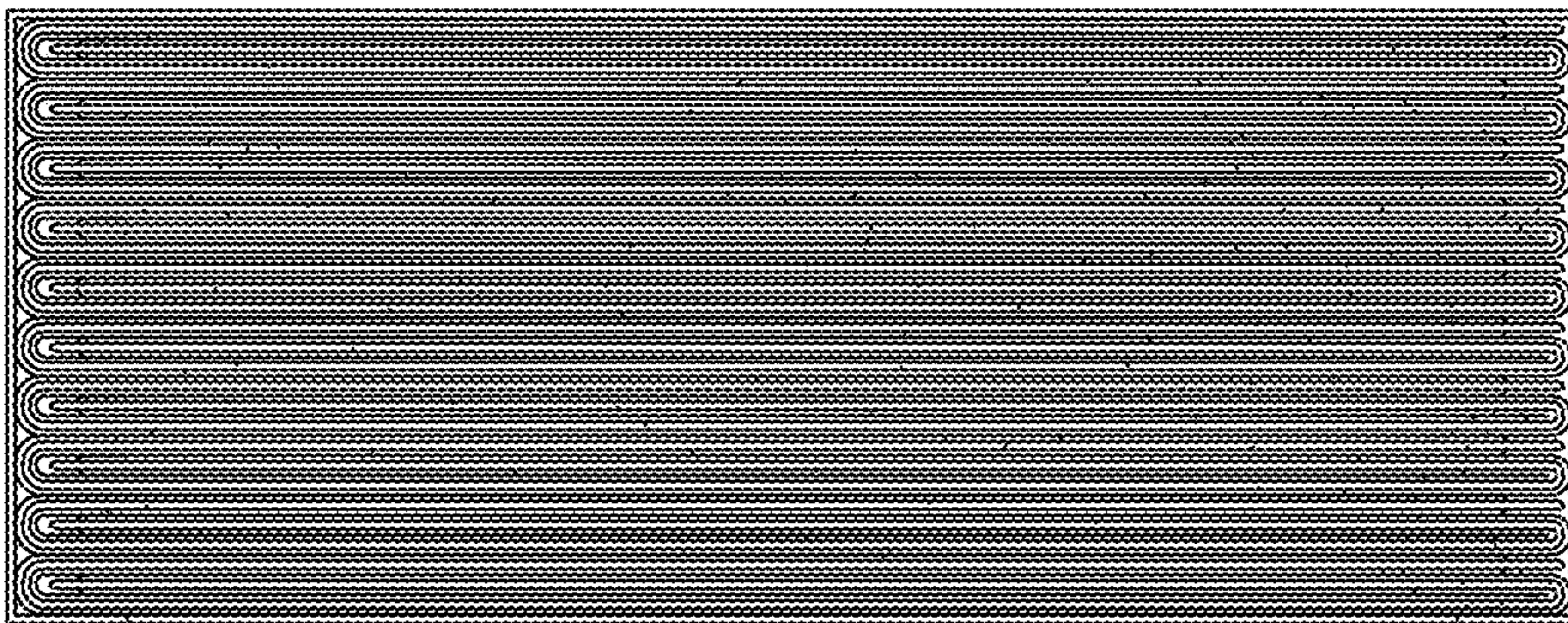

FIG. 4

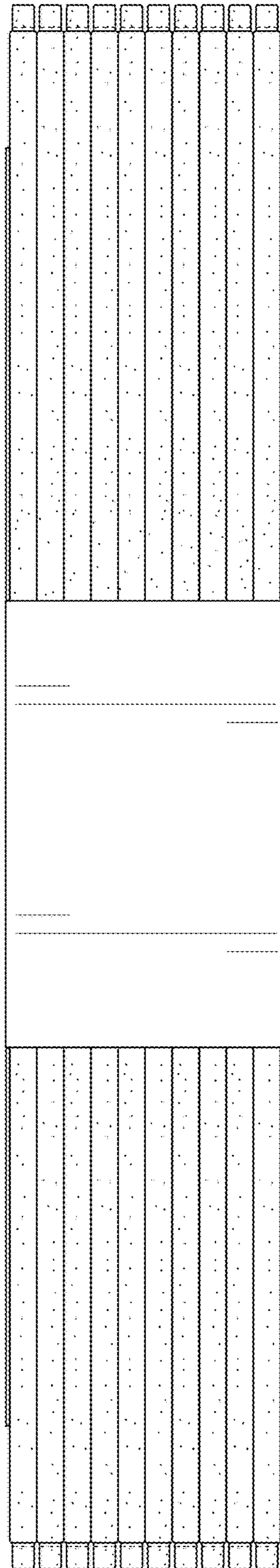

FIG. 6

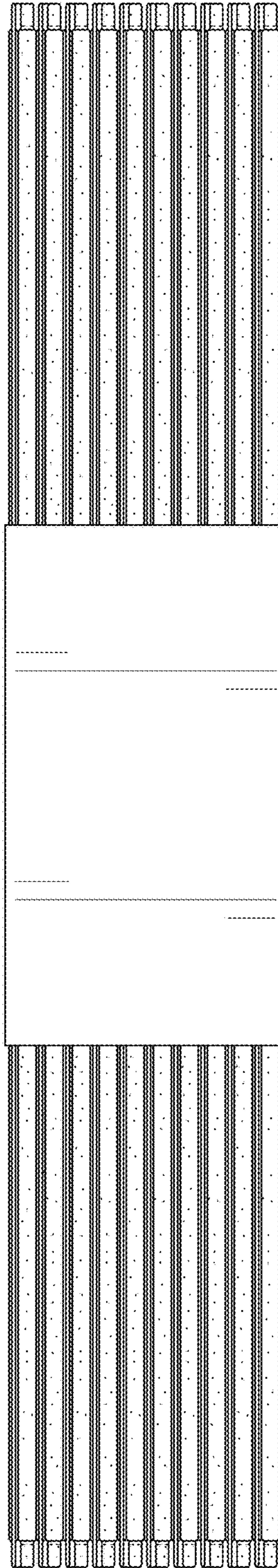

FIG. 7