



US00D824102S

(12) **United States Design Patent**
Go

(10) **Patent No.:** **US D824,102 S**

(45) **Date of Patent:** **** Jul. 24, 2018**

(54) **RAZOR HANDLE**

(71) Applicant: **Dorco Co., Ltd.**, Seoul (KR)

(72) Inventor: **Woo-Gyeong Go**, Seoul (KR)

(73) Assignee: **Dorco Co., Ltd.**, Seoul (KR)

(**) Term: **15 Years**

(21) Appl. No.: **29/585,043**

(22) Filed: **Nov. 18, 2016**

(30) **Foreign Application Priority Data**

May 20, 2016 (KR) 30-2016-0023999

(51) **LOC (11) Cl.** **28-03**

(52) **U.S. Cl.**
USPC **D28/48**

(58) **Field of Classification Search**
USPC D28/46-48
CPC B26B 21/08-21/32; B26B 21/34-21/38;
B26B 21/52-21/4062; B26B
21/4068-21/4075
See application file for complete search history.

(56) **References Cited**

U.S. PATENT DOCUMENTS

D624,700 S * 9/2010 Jung D28/46
D624,701 S * 9/2010 Jung D28/48
D674,552 S * 1/2013 Barrow D28/48

D699,000 S * 2/2014 Bae D28/48
D699,395 S * 2/2014 Bae D28/48
D730,579 S * 5/2015 Han D28/48
D739,980 S * 9/2015 Psimadas D28/48
D745,215 S * 12/2015 Go D28/48
D749,266 S * 2/2016 Go D28/48
D768,929 S * 10/2016 Go D28/48
D787,127 S * 5/2017 Dubin D28/48
D789,609 S * 6/2017 Kong D28/48
D802,212 S * 11/2017 Bae D28/48

* cited by examiner

Primary Examiner — Jennifer Rivard

(74) *Attorney, Agent, or Firm* — Perkins Coie LLP

(57) **CLAIM**

The ornamental design for a razor handle, as shown and described.

DESCRIPTION

FIG. 1 is a perspective view of a razor handle showing my new design;
FIG. 2 is a first side view of the razor handle;
FIG. 3 is a second side view of the razor handle;
FIG. 4 is a front view of the razor handle;
FIG. 5 is a rear view of the razor handle;
FIG. 6 is a top plan view of the razor handle;
FIG. 7 is a bottom plan view of the razor handle; and,
FIG. 8 is an additional perspective view of the razor handle.
The broken lines illustrate the environment of the razor handle and form no part of the claimed design.

1 Claim, 5 Drawing Sheets

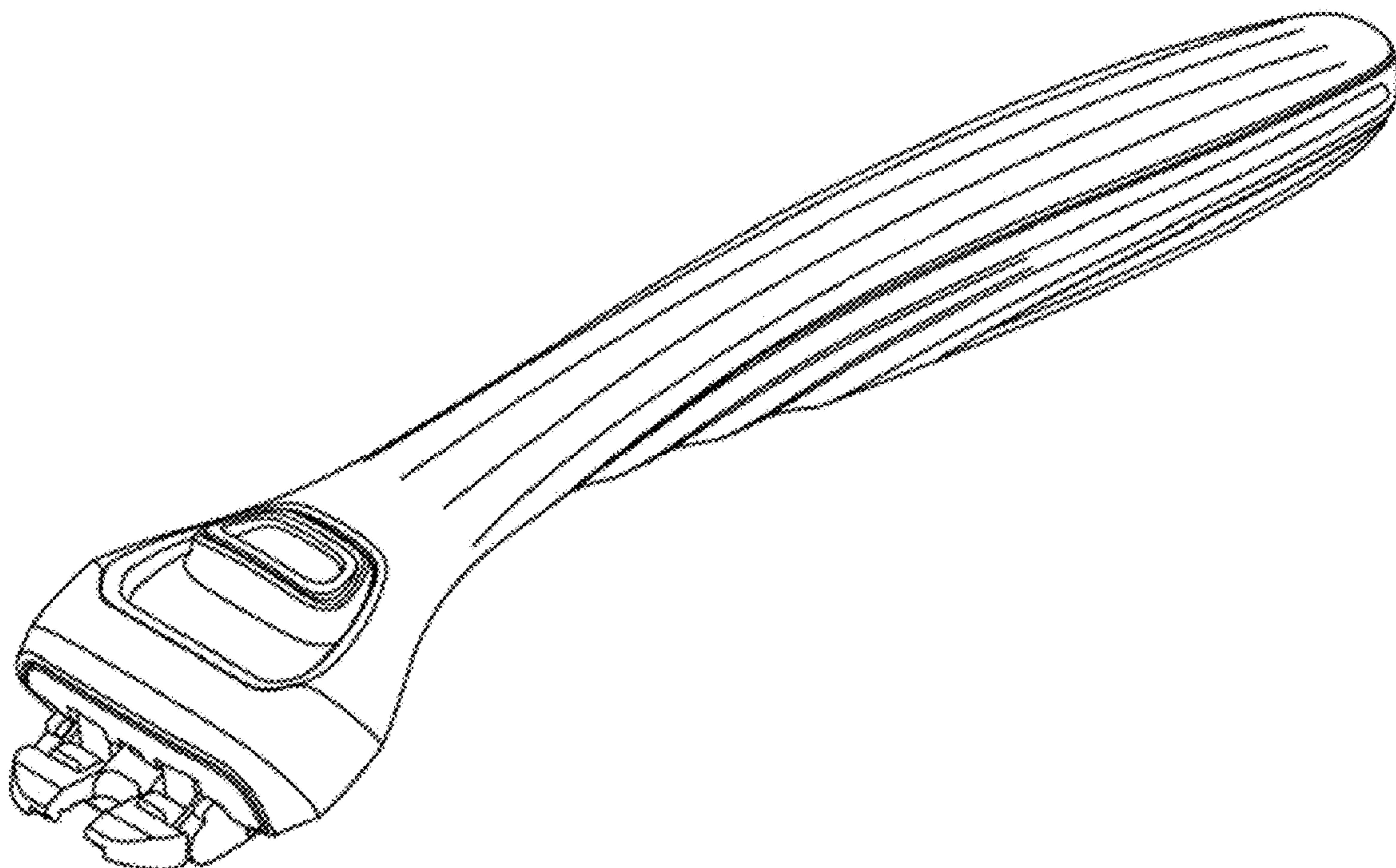

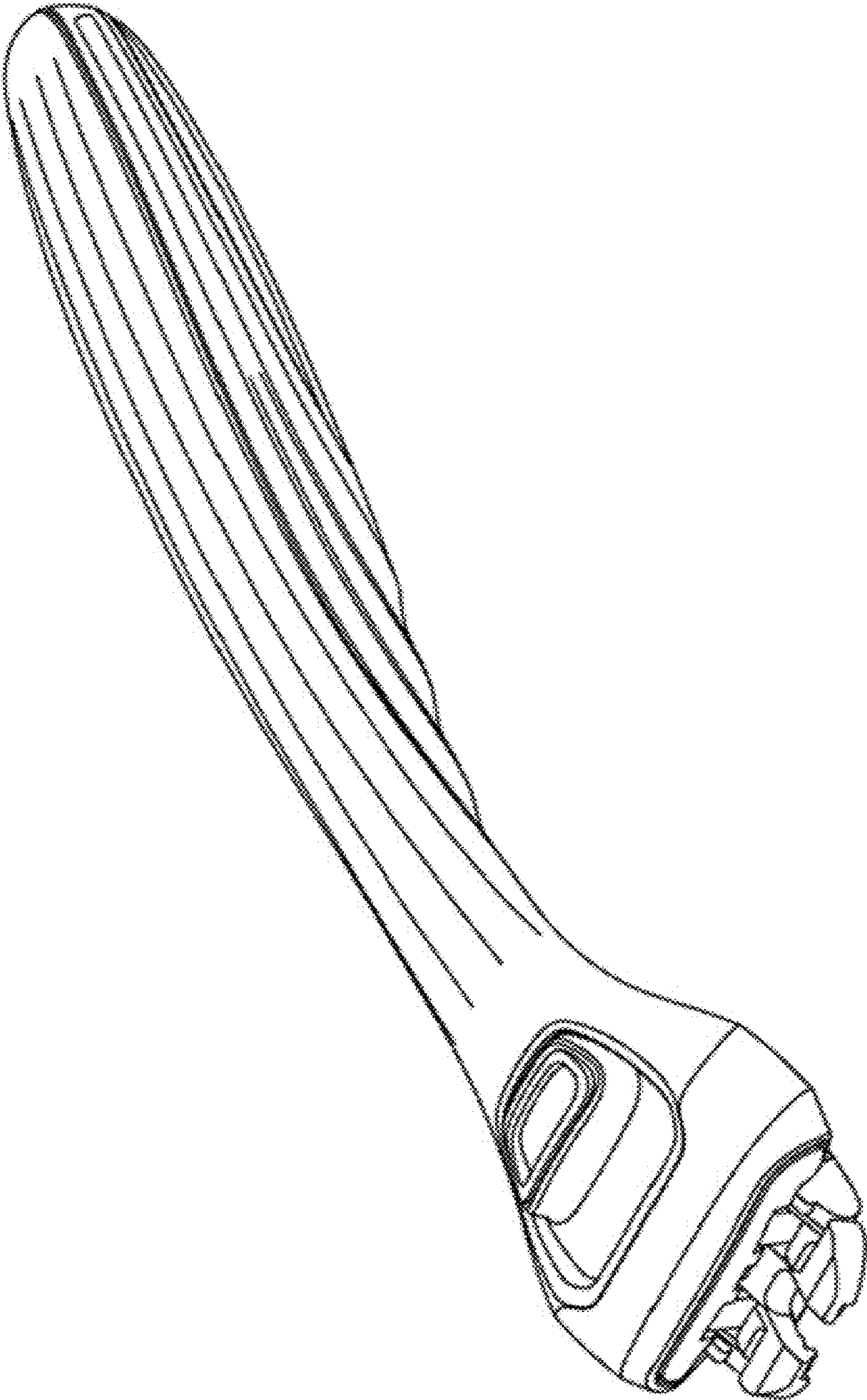

FIG. 1

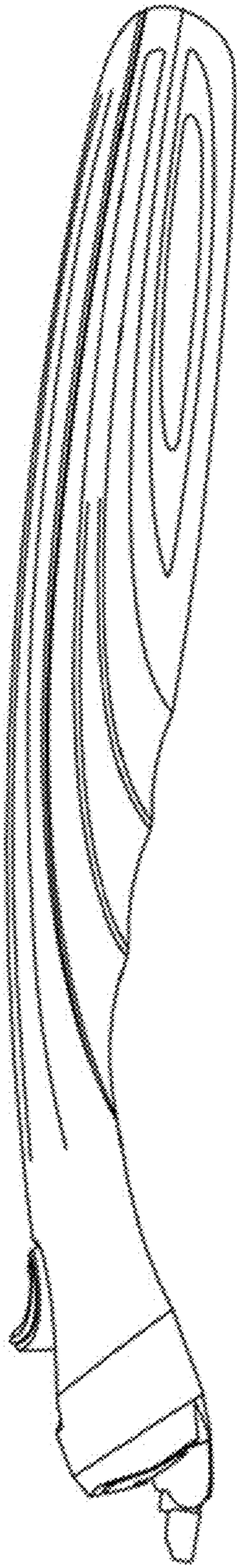

FIG. 2

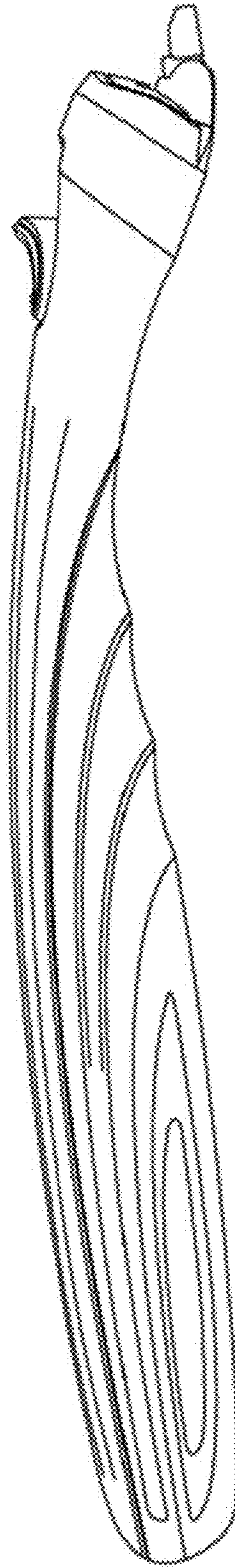

FIG. 3

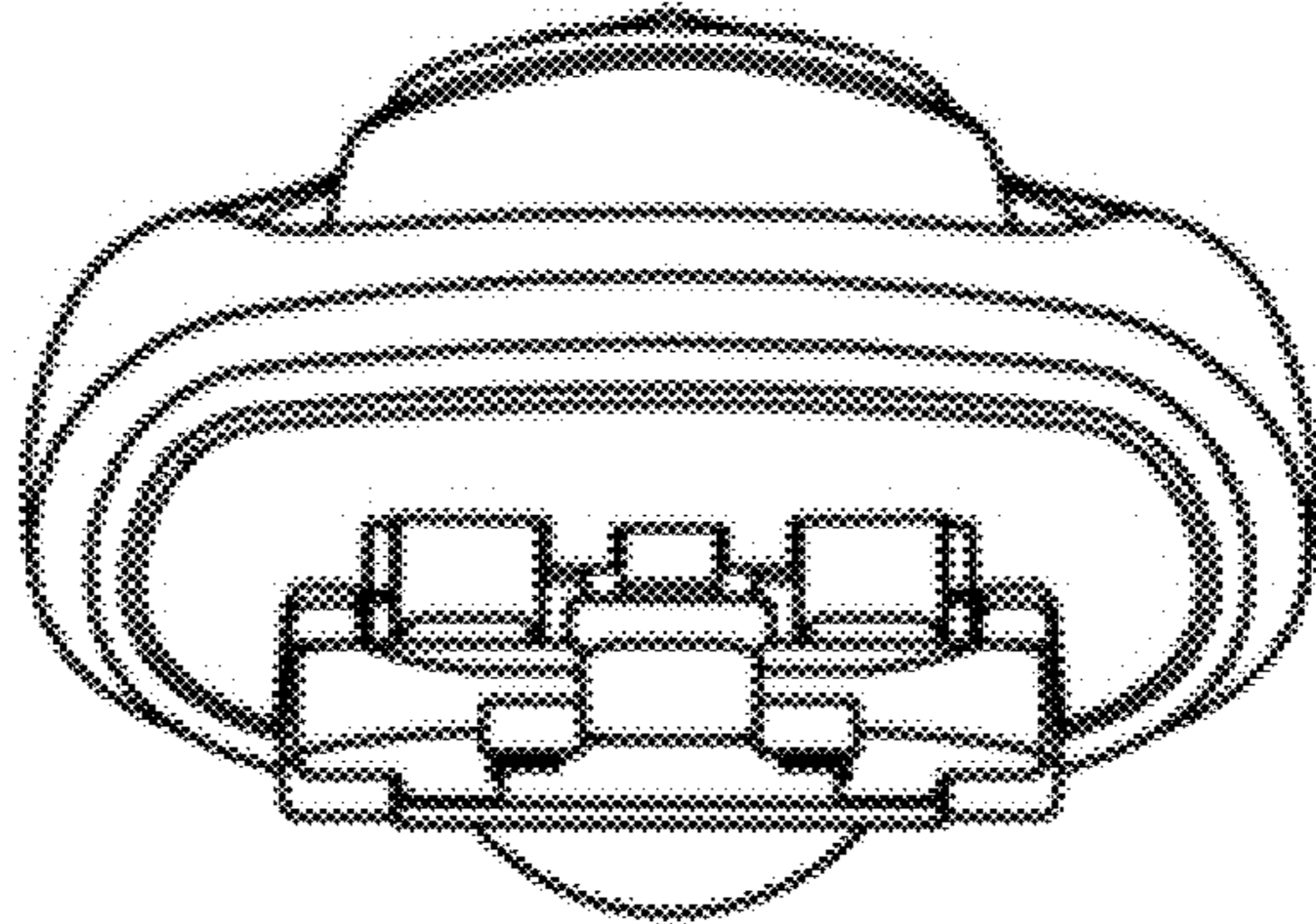

FIG. 4

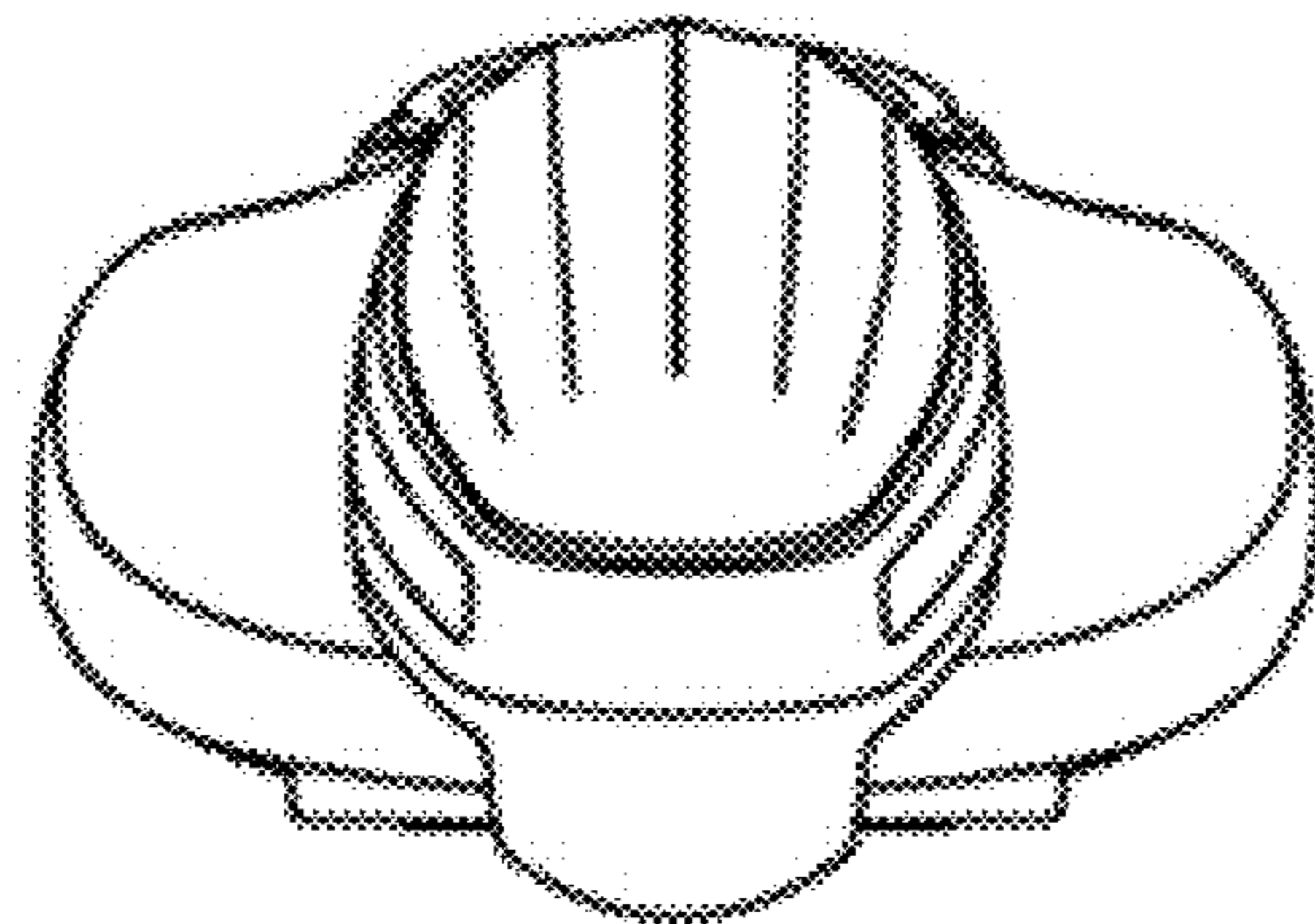

FIG. 5

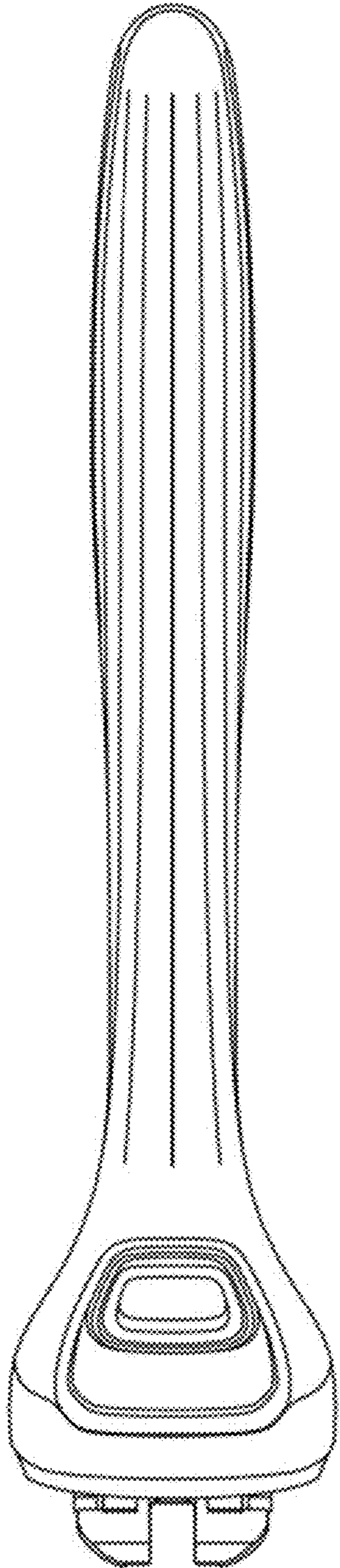

FIG. 6

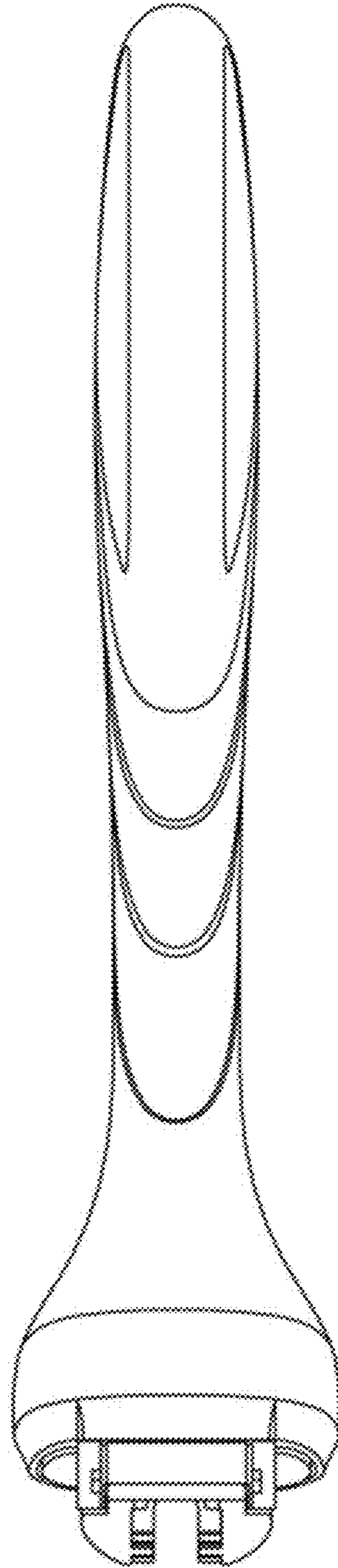

FIG. 7

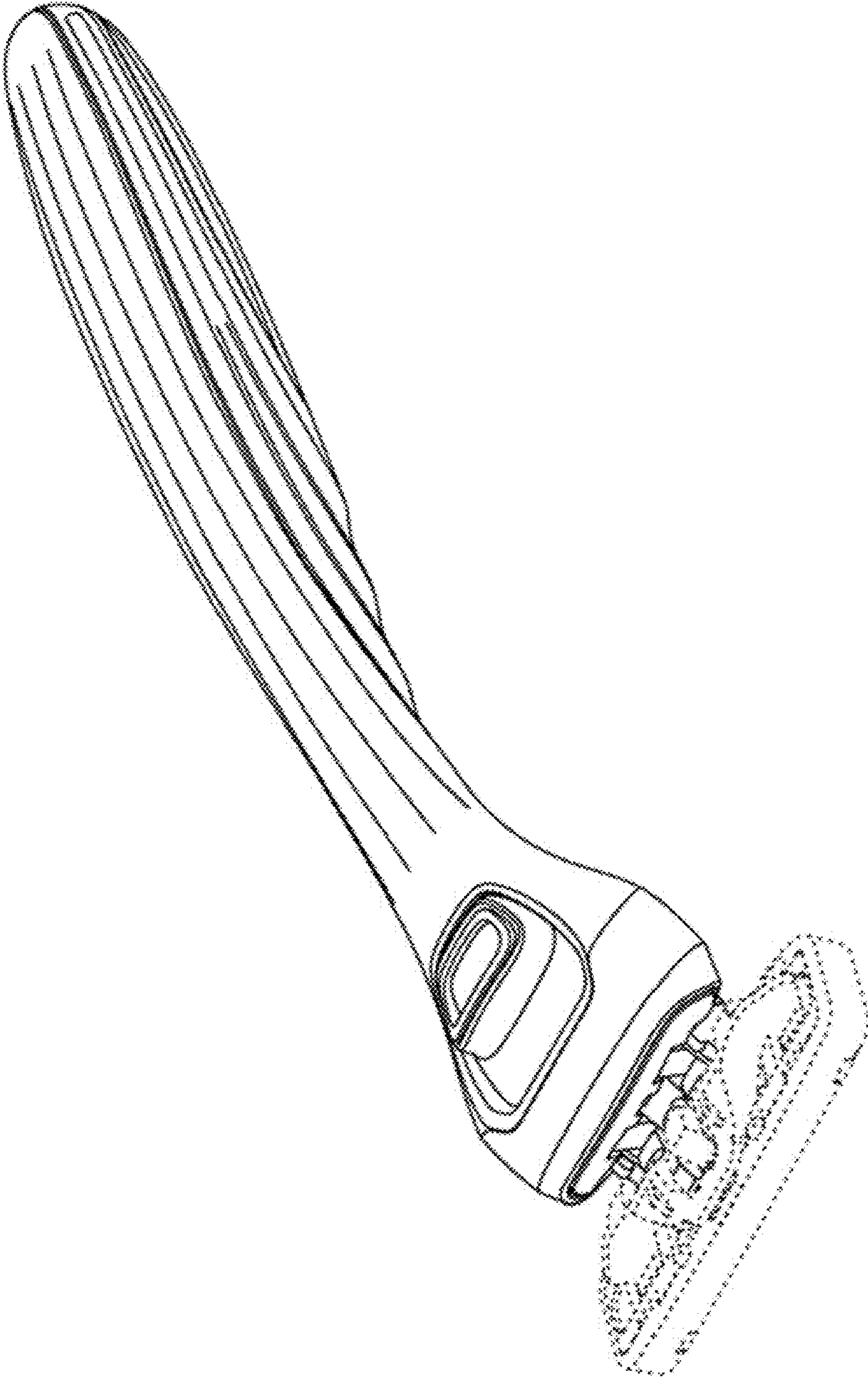

FIG. 8