



US00D824021S

(12) **United States Design Patent** (10) **Patent No.:** **US D824,021 S**
Prentice et al. (45) **Date of Patent:** **** Jul. 24, 2018**

(54) **FACE MASK FRAME**

(71) Applicant: **Fisher & Paykel Healthcare Limited**,
Auckland (NZ)

(72) Inventors: **Craig Robert Prentice**, Auckland (NZ);
Bernard Tsz Lun Ip, Auckland (NZ);
Mark Arvind McLaren, Auckland
(NZ); **Kyle Gregory Brown**, Auckland
(NZ); **Chris Onin Limpin Hipolito**,
Auckland (NZ); **Mark Richard**
Tomlinson, Auckland (NZ); **Melissa**
Catherine Bornholdt, Auckland (NZ)

(73) Assignee: **FISHER & PAYKEL HEALTHCARE**
LIMITED, Auckland (NZ)

(**) Term: **15 Years**

(21) Appl. No.: **29/595,877**

(22) Filed: **Mar. 2, 2017**

Related U.S. Application Data

(63) Continuation of application No. 29/540,693, filed on
Sep. 25, 2015, now Pat. No. Des. 784,516.

(51) **LOC (11) Cl.** **29-02**

(52) **U.S. Cl.**
USPC **D24/110.4**

(58) **Field of Classification Search**
USPC D24/110-110.5, 127, 164
CPC A61M 16/0605; A61M 16/0622; A61M
16/06; A61M 16/0616; A61M 16/0661;
A61M 16/0633; A61M 16/0644; A61M
16/0816; A61M 16/08; A61M 16/0666;
A61M 2210/0618; A61M 16/0683

See application file for complete search history.

(56) **References Cited**

U.S. PATENT DOCUMENTS

D383,204 S 9/1997 Lomas et al.
6,631,718 B1 10/2003 Lovell et al.
6,691,707 B1 2/2004 Gunaratnam et al.
D539,901 S 4/2007 McAuliffe et al.
7,290,546 B2 11/2007 Sprinkle et al.
D556,899 S 12/2007 Veliss et al.
D579,105 S 10/2008 Jones et al.
D597,202 S 7/2009 Reid et al.
7,793,987 B1 9/2010 Busch et al.
D637,283 S 5/2011 Selvarajan et al.

(Continued)

OTHER PUBLICATIONS

F&P Eson 2 Nasal Mask: Confidence Comes Easy with Eson 2.
Fisher & Paykel Healthcare. (Year: 2015).*

(Continued)

Primary Examiner — Karen E Kearney

Assistant Examiner — Lilyana Bekic

(74) *Attorney, Agent, or Firm* — Knobbe, Martens, Olson
and Bear, LLP

(57) **CLAIM**

The ornamental design for a face mask frame, as shown and
described.

DESCRIPTION

FIG. 1 is a top, front and side perspective view of a face
mask frame showing our new design;
FIG. 2 is a top, rear and side perspective view thereof;
FIG. 3 is a front view thereof;
FIG. 4 is a rear view thereof;
FIG. 5 is a first side view thereof;
FIG. 6 is a second side view thereof;
FIG. 7 is a top view thereof; and,
FIG. 8 is a bottom view thereof.

Broken lines are used to illustrate features of the face mask
frame which form no part of the claimed design.

1 Claim, 8 Drawing Sheets

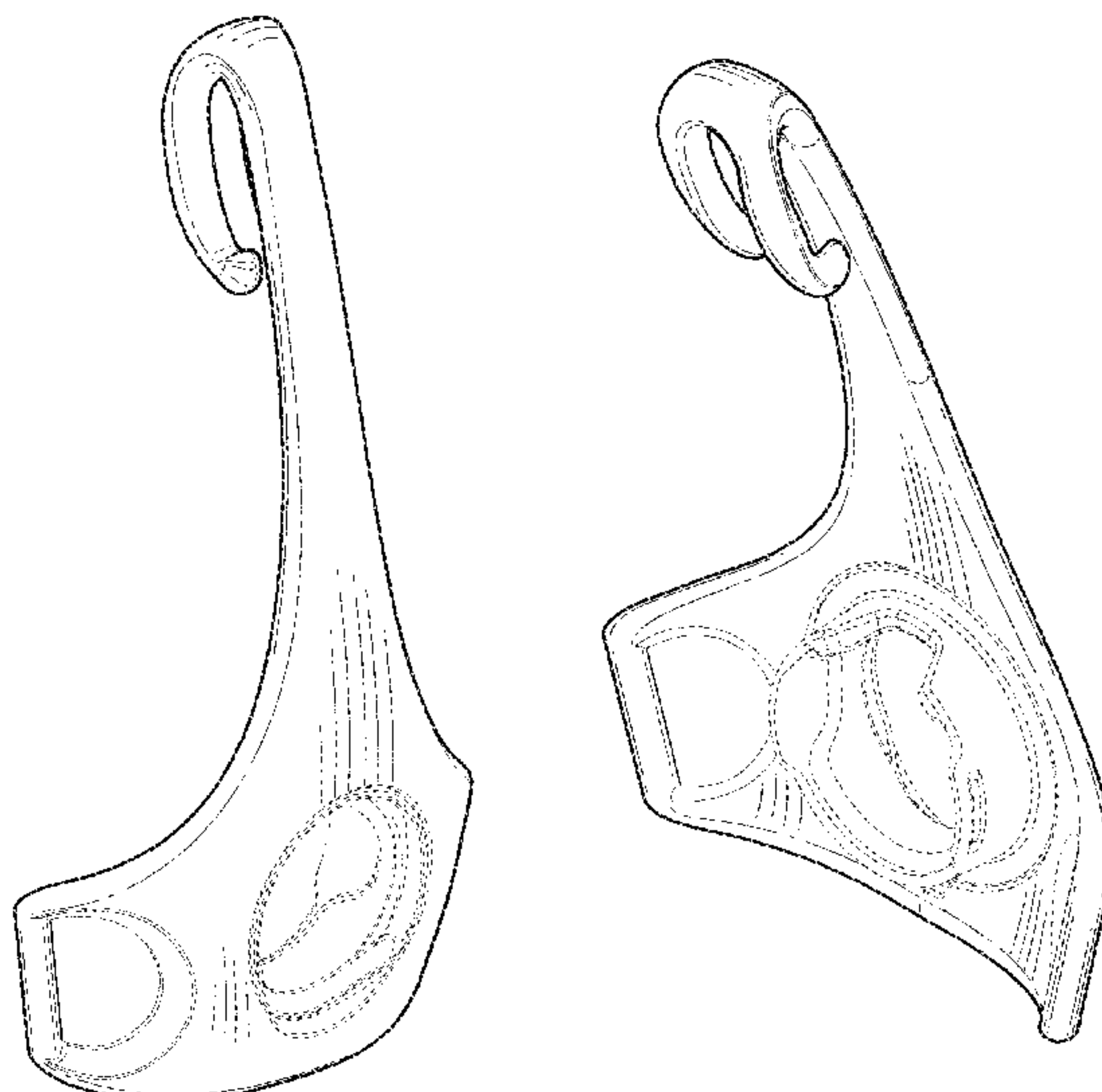

(56)

References Cited

U.S. PATENT DOCUMENTS

D651,304 S 12/2011 Edwards et al.
 D656,231 S 3/2012 Henry et al.
 D679,376 S 4/2013 Von Hollen et al.
 D679,377 S 4/2013 Von Hollen et al.
 D679,378 S 4/2013 Von Hollen et al.
 D683,447 S * 5/2013 Olsen D24/110.1
 D692,554 S 10/2013 Siew et al.
 D693,459 S * 11/2013 Prentice D24/110.1
 D696,767 S 12/2013 Scheiner et al.
 D697,203 S 1/2014 Clarke et al.
 D706,413 S 6/2014 Veliss et al.
 D717,945 S 11/2014 Neff et al.
 8,950,404 B2 2/2015 Formica et al.
 D740,934 S 10/2015 Formica et al.
 D748,242 S 1/2016 Campbell et al.
 D751,188 S 3/2016 Skipper et al.
 D753,813 S 4/2016 Ozolins et al.
 D754,328 S 4/2016 Bowsher et al.
 D782,030 S * 3/2017 Prentice D24/110.4
 D782,031 S * 3/2017 Prentice D24/110.4
 D784,516 S * 4/2017 Prentice D24/110.4
 D809,132 S * 1/2018 Bornholdt D24/110.4
 2002/0023649 A1 2/2002 Gunaratnam
 2002/0026934 A1 3/2002 Lithgow
 2003/0196659 A1 10/2003 Gradon et al.
 2004/0083534 A1 5/2004 Ruiz
 2004/0112377 A1 6/2004 Amarasinghe
 2007/0175480 A1 8/2007 Gradon et al.
 2008/0192459 A1 8/2008 Kwok et al.
 2009/0194111 A1 8/2009 Fu et al.
 2010/0000538 A1 1/2010 Edwards et al.
 2010/0031963 A1 2/2010 Lee et al.

2010/0059058 A1 3/2010 Kuo
 2011/0197341 A1 8/2011 Formica et al.
 2012/0204881 A1 8/2012 Davidson et al.
 2012/0234326 A1 9/2012 Mazzone et al.
 2013/0152937 A1 6/2013 Jablonski et al.
 2013/0152938 A1 6/2013 Jablonski et al.
 2013/0239972 A1 9/2013 McAuley et al.
 2014/0090649 A1 4/2014 Groll et al.
 2014/0096774 A1 4/2014 Olsen et al.
 2014/0305433 A1 10/2014 Rothermel
 2014/0326246 A1 11/2014 Chodkowski et al.
 2015/0151069 A1 6/2015 Zeijlstra et al.
 2015/0306320 A1 10/2015 Markus
 2015/0367092 A1 12/2015 Goff et al.
 2016/0008558 A1* 1/2016 Huddart A61M 16/06
 128/205.25
 2016/0067442 A1 3/2016 Salmon et al.
 2016/0082218 A1 3/2016 Lau et al.
 2016/0121067 A1 5/2016 VanMiddendorp et al.
 2016/0220781 A1* 8/2016 Arrowsmith A61M 16/208
 2016/0354572 A1* 12/2016 Lim A61M 16/0616
 2017/0065786 A1* 3/2017 Stephenson A61M 16/06

OTHER PUBLICATIONS

Fisher Paykel Eson 2 Review Instructions. CPAP Reviews. YouTube.com. Date published: Feb. 25, 2016. <<https://www.youtube.com/watch?v=c0g0eAvRhK8>> (Year: 2016).*
 Swivel for Fisher Paykel Eson2 Nasal Mask #400FPH241. CPAP Australia. www.cpapaustralia.com.au. Date accessed: May 21, 2016. <<https://www.cpapaustralia.com.au/shopping/swivel-for-fisher-paykel-eson2-nasal-mask-400fph241.html>>.

* cited by examiner

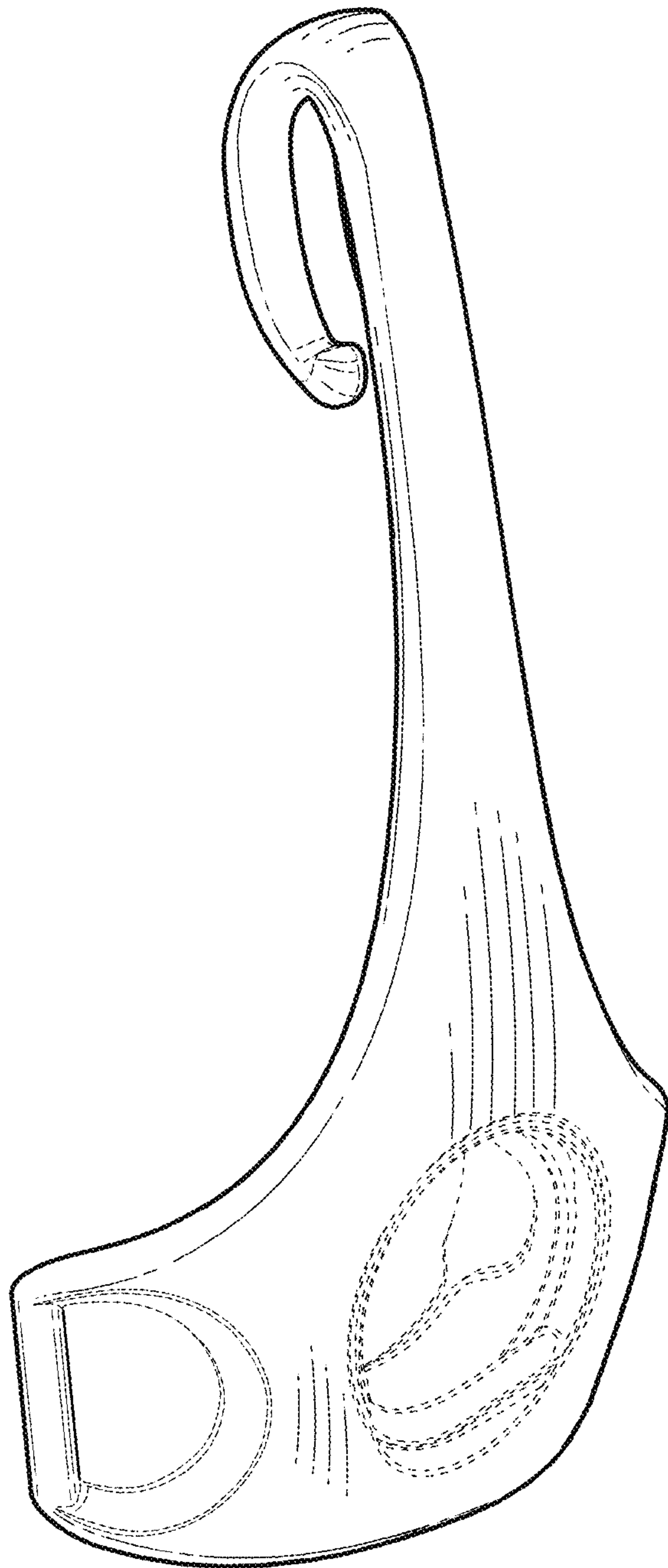

FIG. 1

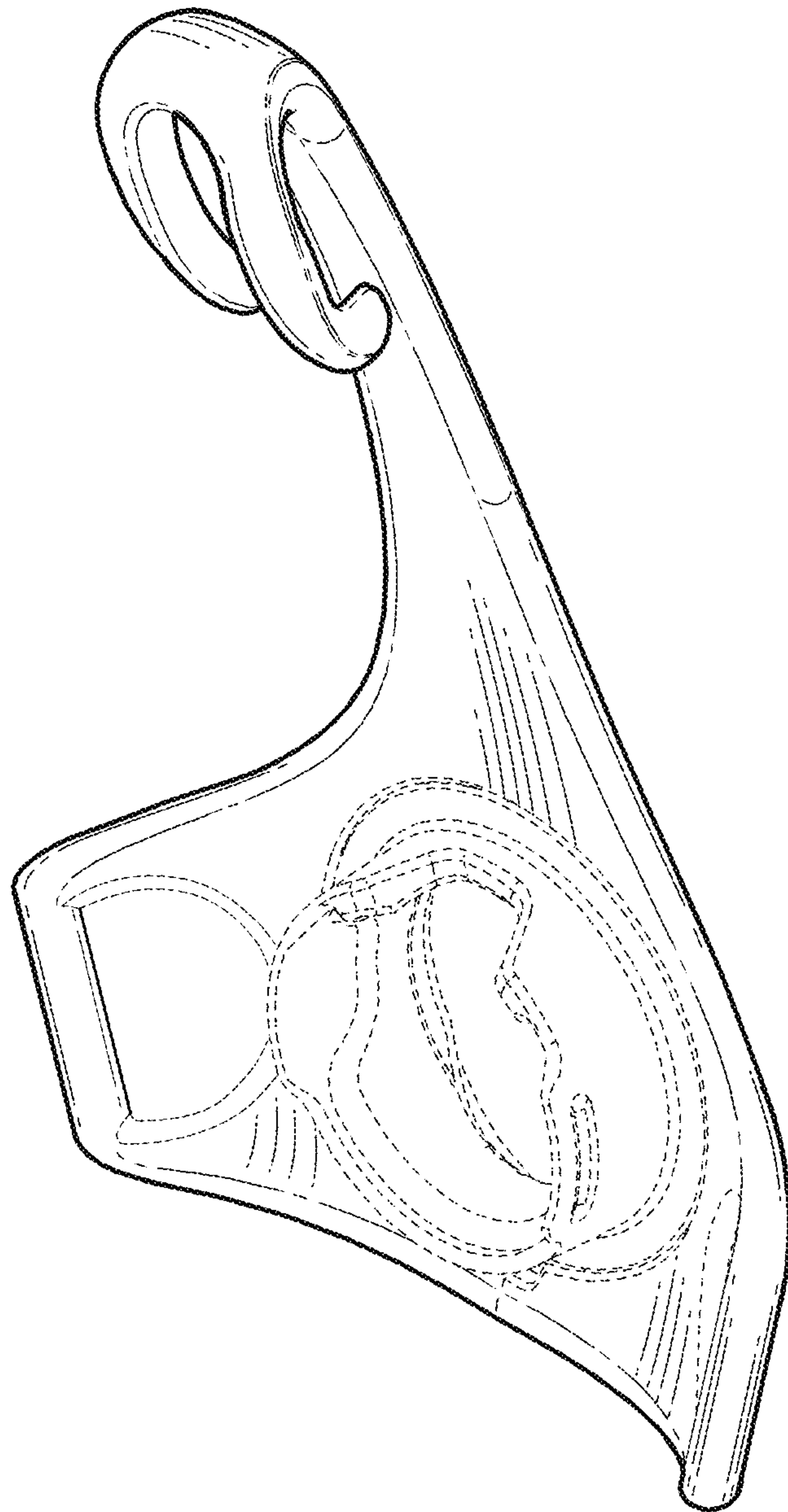

FIG. 2

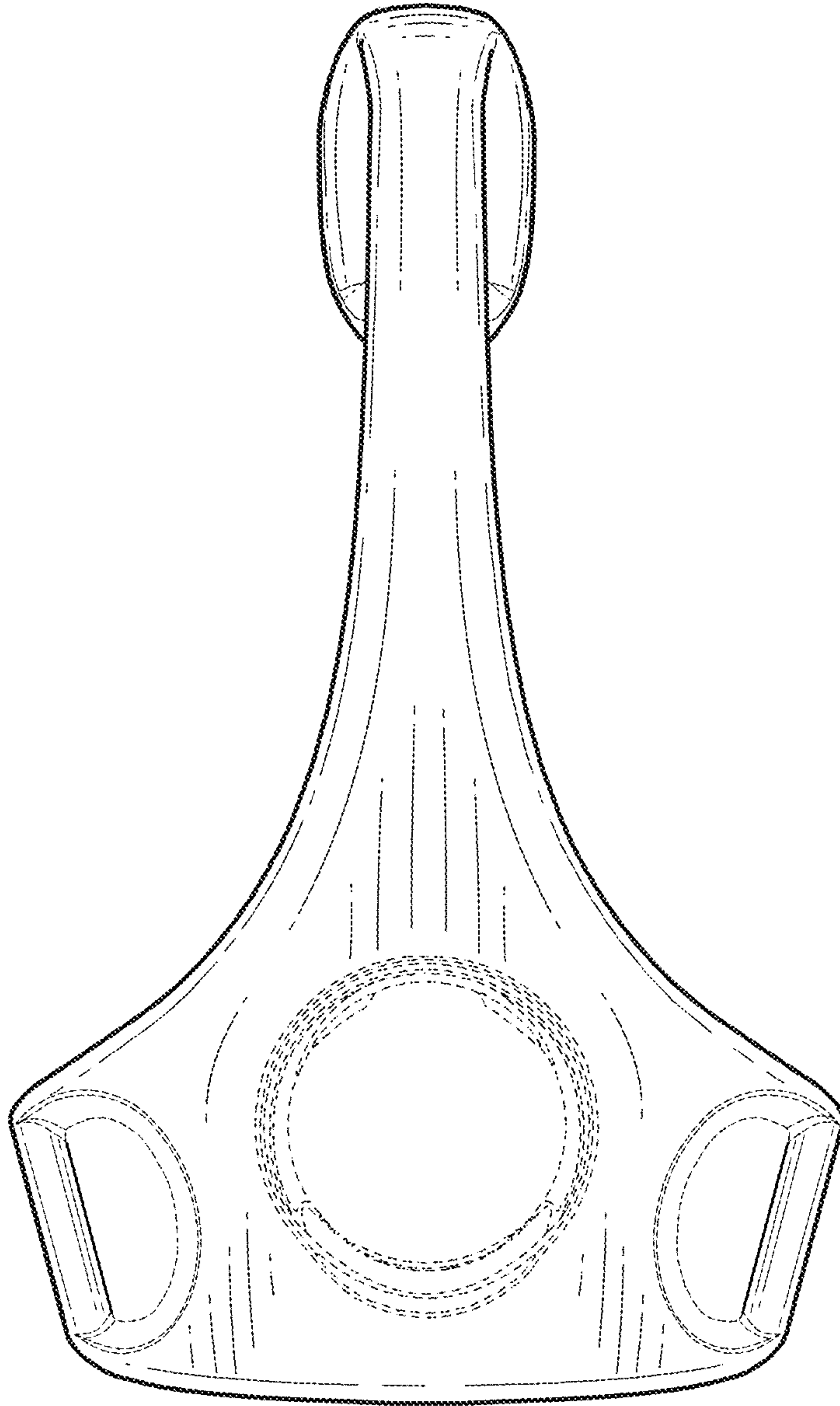

FIG. 3

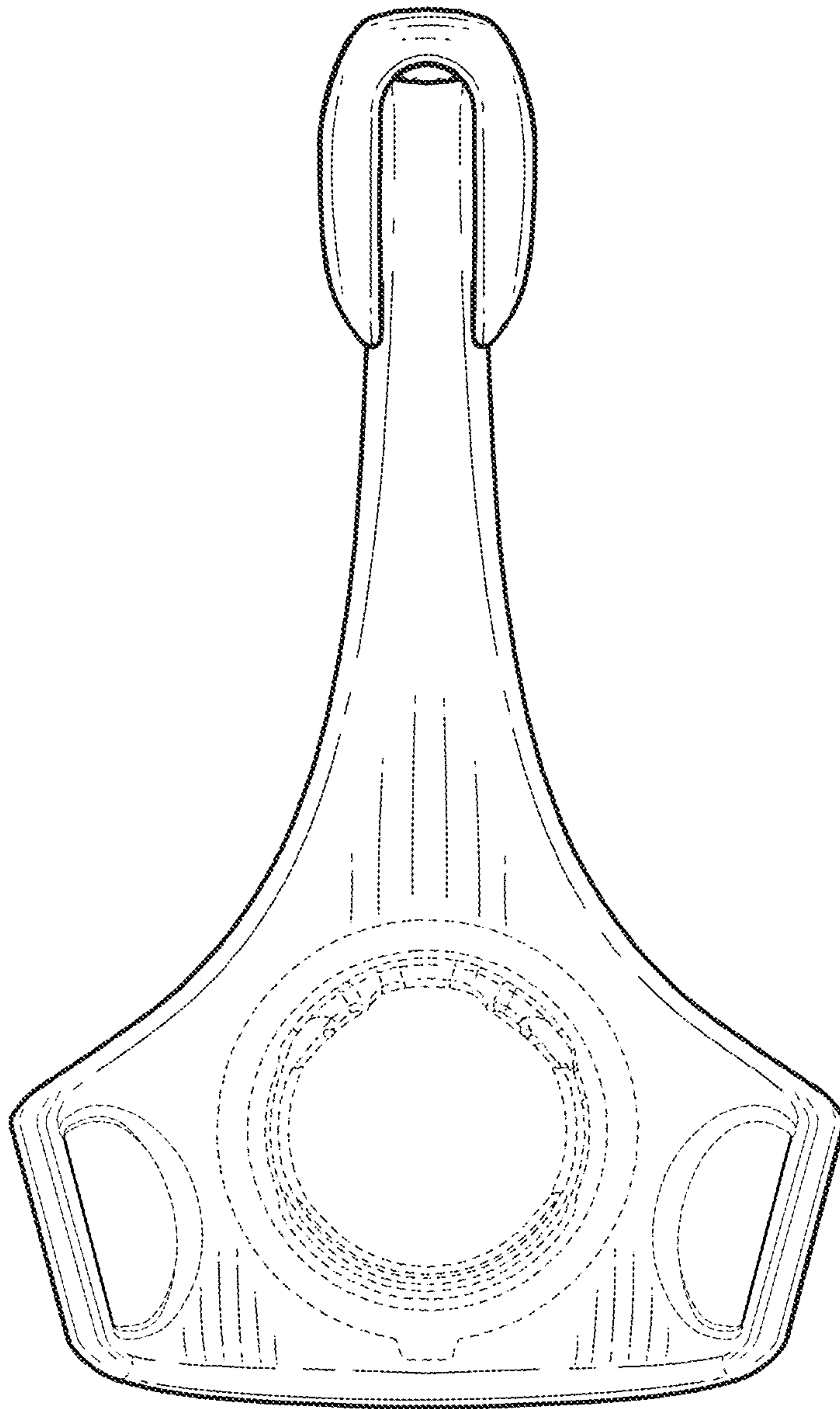

FIG. 4

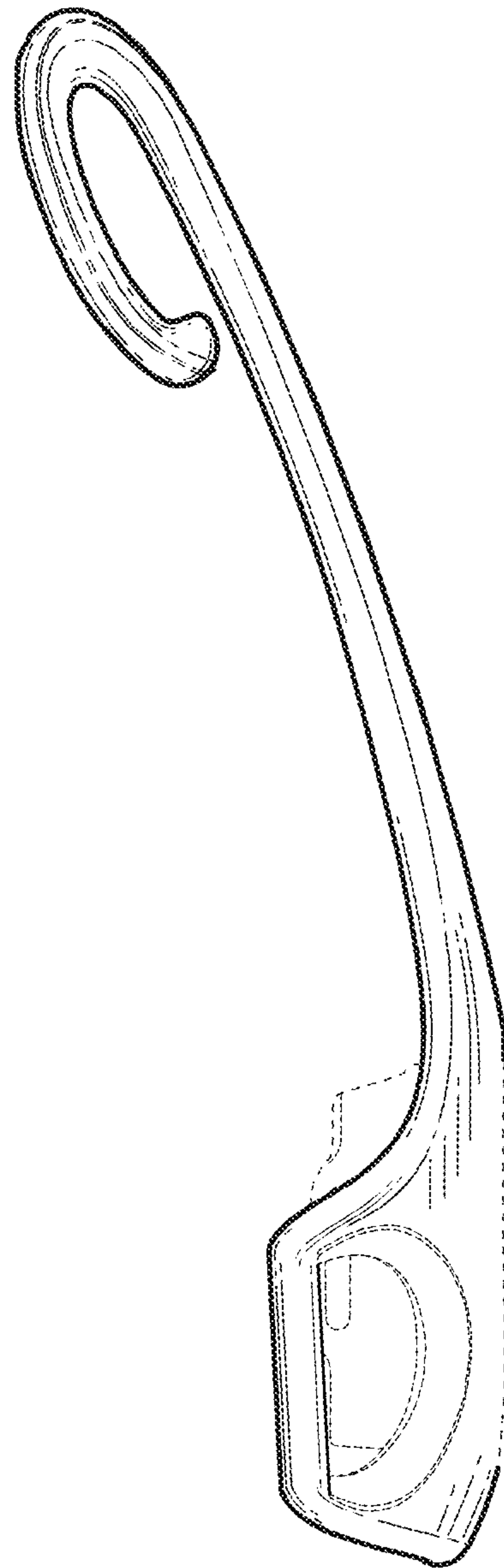

FIG. 5

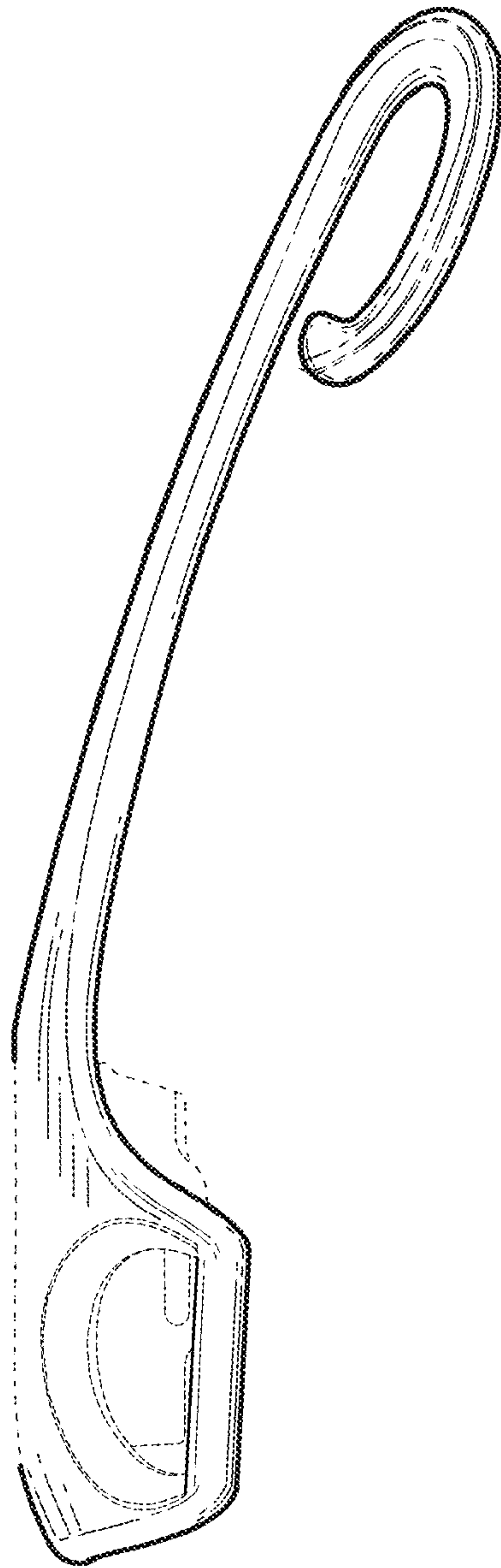

FIG. 6

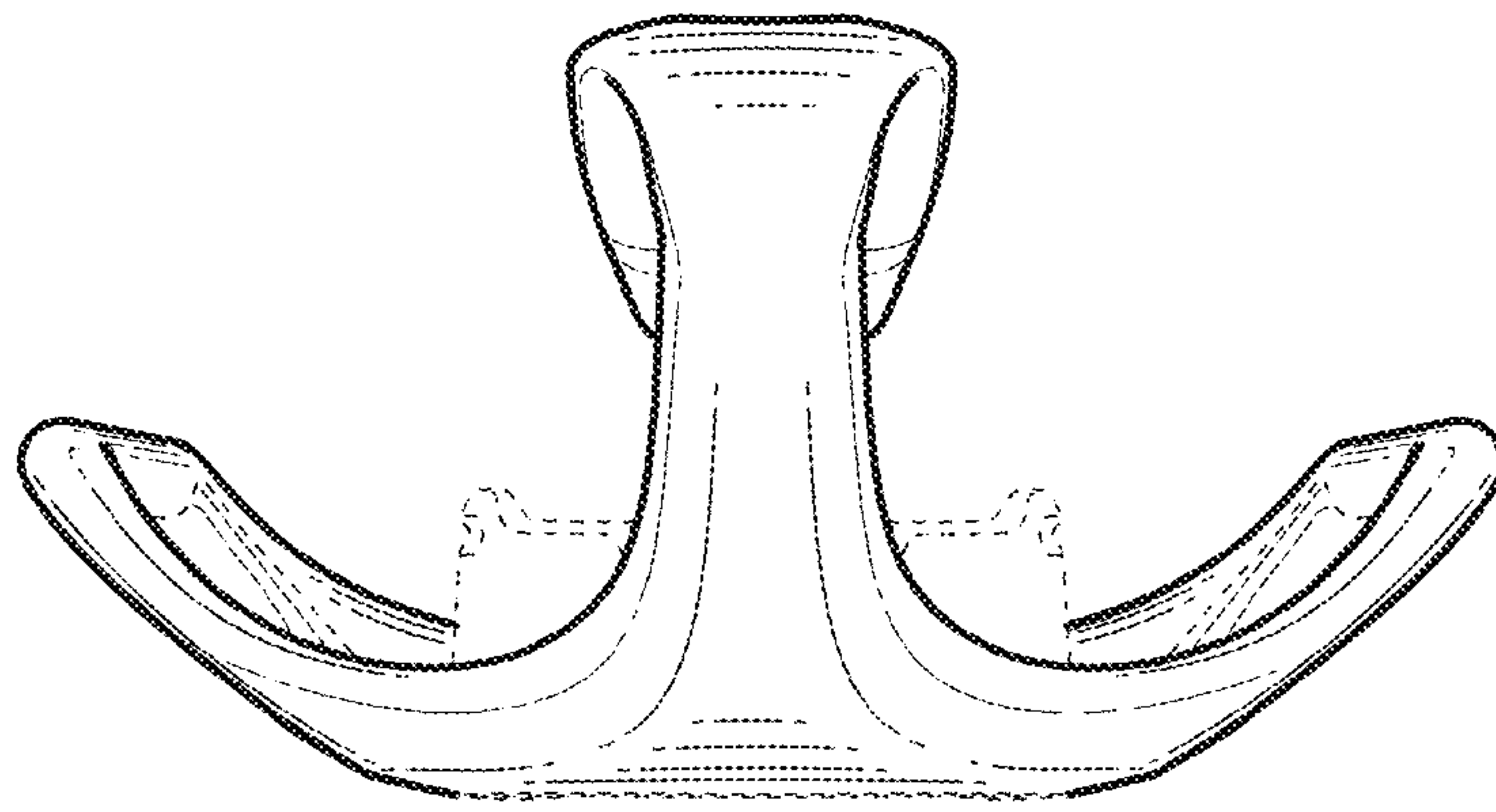

FIG. 7

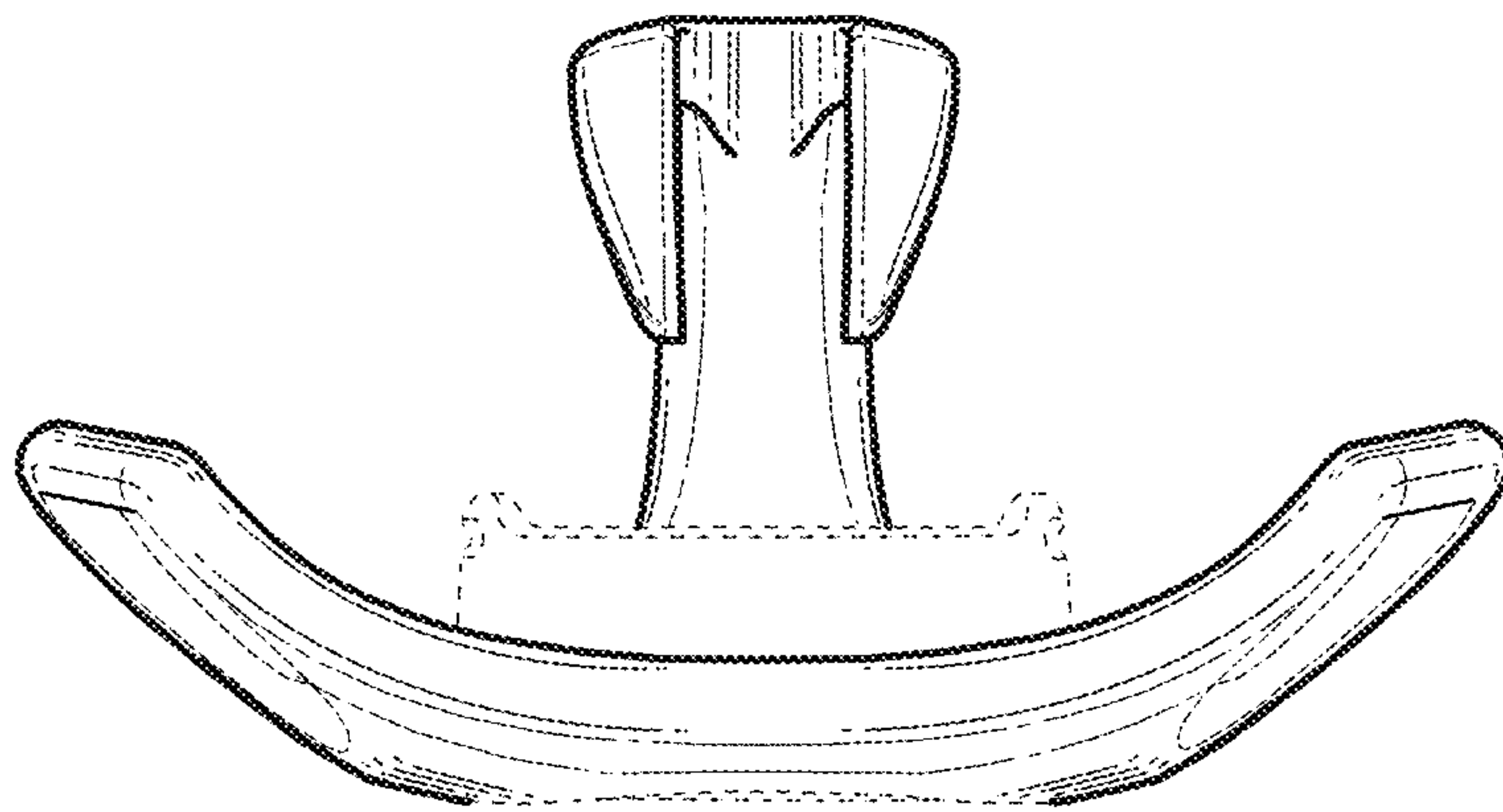

FIG. 8