



US00D823984S

(12) **United States Design Patent**  
**Müller**

(10) **Patent No.:** **US D823,984 S**

(45) **Date of Patent:** **\*\* Jul. 24, 2018**

(54) **TOILET RIM CAGE**

(71) Applicant: **TOMIL S.R.O.**, Vysoké Myto (CZ)

(72) Inventor: **Tomas Müller**, Hradec Kralove (CZ)

(73) Assignee: **TOMIL S.R.O.**, Vysoké Myto (CZ)

(\*\*) Term: **15 Years**

(21) Appl. No.: **35/502,539**

(22) Filed: **Jan. 11, 2017**

(80) **Hague Agreement Data**

Int. Filing Date: **Jan. 11, 2017**

Int. Reg. No.: **DM/094846**

Int. Reg. Date: **Jan. 11, 2017**

Int. Reg. Pub. Date: **Mar. 3, 2017**

(51) **LOC (11) Cl.** ..... **23-01**

(52) **U.S. Cl.**

USPC ..... **D23/208**

(58) **Field of Classification Search**

USPC ..... D23/207, 208, 366, 368

CPC ..... A61L 9/00; A61L 9/02; A61L 9/03; A61L 9/032; A61L 9/035; A61L 9/037; A61L 9/04; A61L 9/12; A61L 9/22; C11D 17/041; C11D 17/0056; E03D 9/032; E03D 9/037; E03D 9/038

See application file for complete search history.

(56) **References Cited**

**U.S. PATENT DOCUMENTS**

D656,575 S *	3/2012	Muhlhausen	.....	D23/208
D656,576 S *	3/2012	Muhlhausen	.....	D23/208
D659,793 S *	5/2012	Muhlhausen	.....	D23/208
D679,778 S *	4/2013	Gerhards	.....	D23/208
D689,167 S *	9/2013	Gerhards	.....	D23/208
D720,427 S *	12/2014	Wang	.....	D23/208
D722,154 S *	2/2015	Muller	.....	D23/368
D762,810 S *	8/2016	Venini	.....	D23/208
D787,631 S *	5/2017	Gerhards	.....	D23/208

D787,633 S *	5/2017	Gerhards	.....	D23/208
D788,260 S *	5/2017	Gerhards	.....	D23/208
D789,485 S *	6/2017	Hale	.....	D23/208

(Continued)

*Primary Examiner* — Keli L Hill

(74) *Attorney, Agent, or Firm* — The Webb Law Firm

(57) **CLAIM**

The ornamental design for a toilet rim cage, as shown and described.

**DESCRIPTION**

- 1.-4. Toilet rim cages
- 1.1 is a front elevation view.
- 1.2 is a rear elevation view.
- 1.3 is a right side elevation view.
- 1.4 is a left side elevation view.
- 1.5 is a top plan view.
- 1.6 is a bottom plan view.
- 1.7 is a top and front perspective view.
- 2.1 is a front elevation view.
- 2.2 is a rear elevation view.
- 2.3 is a right side elevation view.
- 2.4 is a left side elevation view.
- 2.5 is a top plan view.
- 2.6 is a bottom plan view.
- 2.7 is a top and front perspective view.
- 3.1 is a front elevation view.
- 3.2 is a rear elevation view.
- 3.3 is a right side elevation view.
- 3.4 is a left side elevation view.
- 3.5 is a top plan view.
- 3.6 is a bottom plan view.
- 3.7 is a top and front perspective view.
- 4.1 is a front elevation view.
- 4.2 is a rear elevation view.
- 4.3 is a right side elevation view.
- 4.4 is a left side elevation view.
- 4.5 is a top plan view.
- 4.6 is a bottom plan view.
- 4.7 is a top and front perspective view.

**1 Claim, 28 Drawing Sheets**

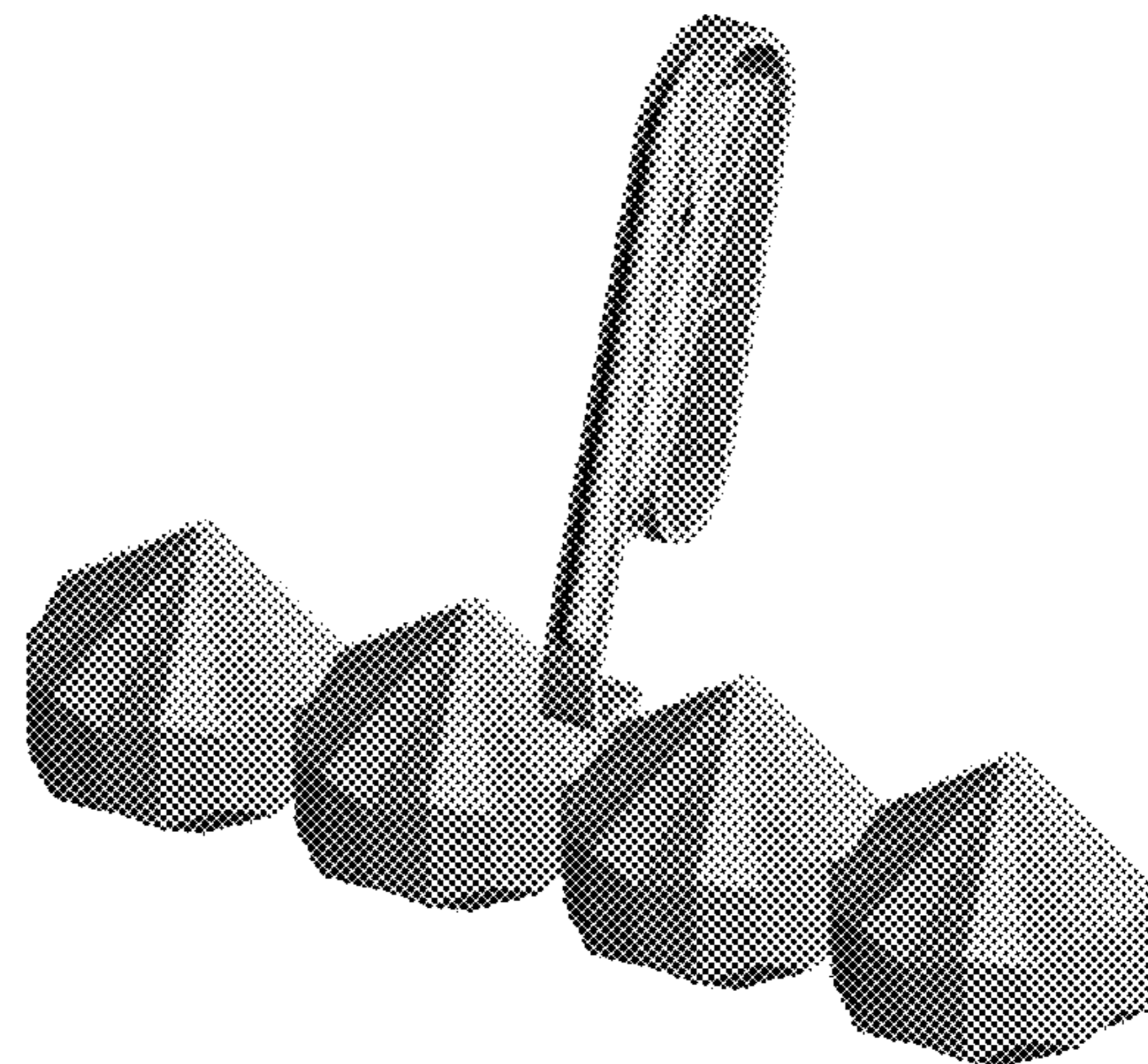
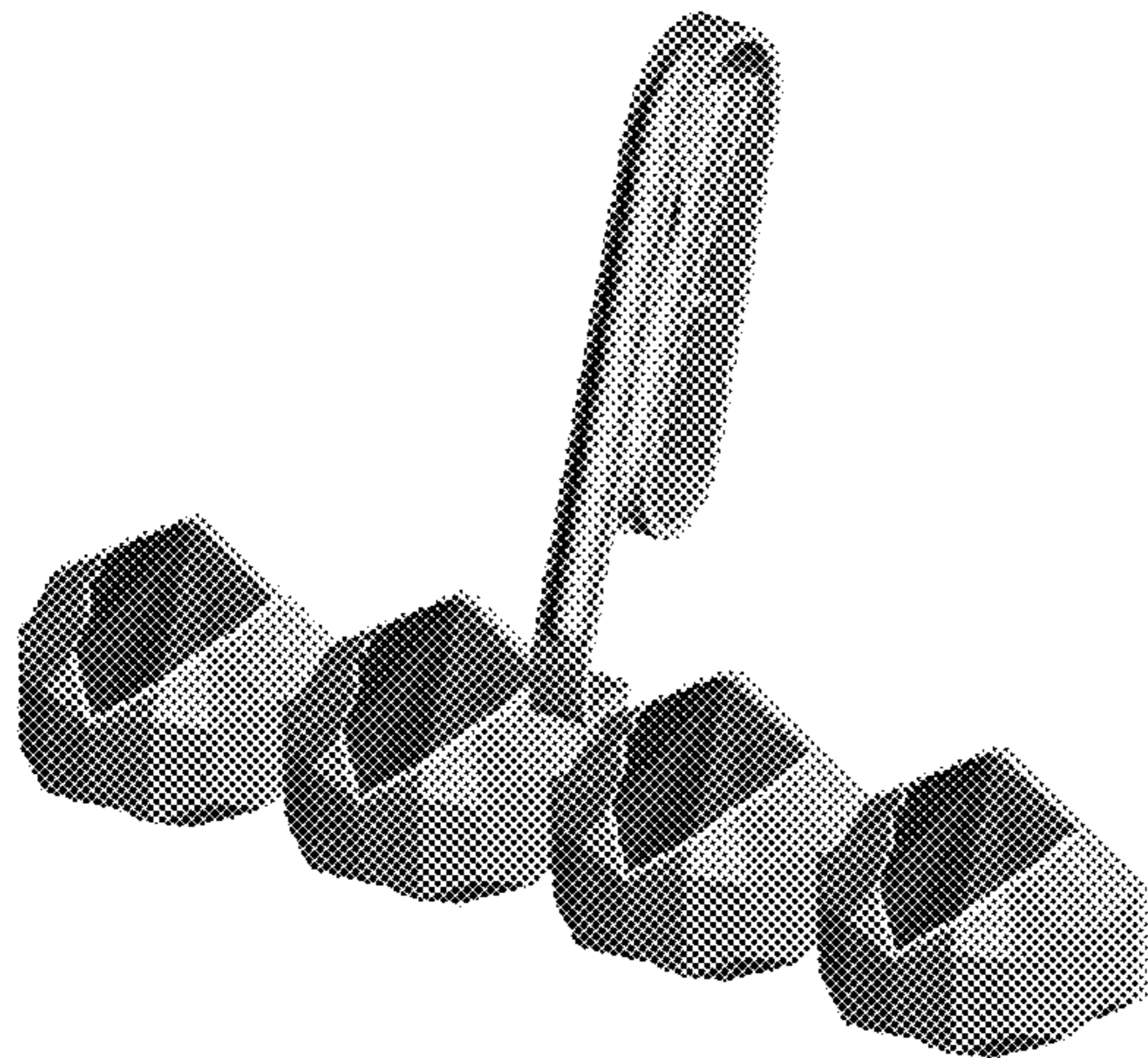

(56)

**References Cited**

U.S. PATENT DOCUMENTS

D789,487 S *	6/2017	Gerhards .....	D23/208
D790,036 S *	6/2017	Gerhards .....	D23/208
D790,658 S *	6/2017	Gerhards .....	D23/208
D791,911 S *	7/2017	Muller .....	D23/208
D795,387 S *	8/2017	Gerhards .....	D23/208
D806,208 S *	12/2017	Gerhards .....	D23/208

\* cited by examiner

**1.1**

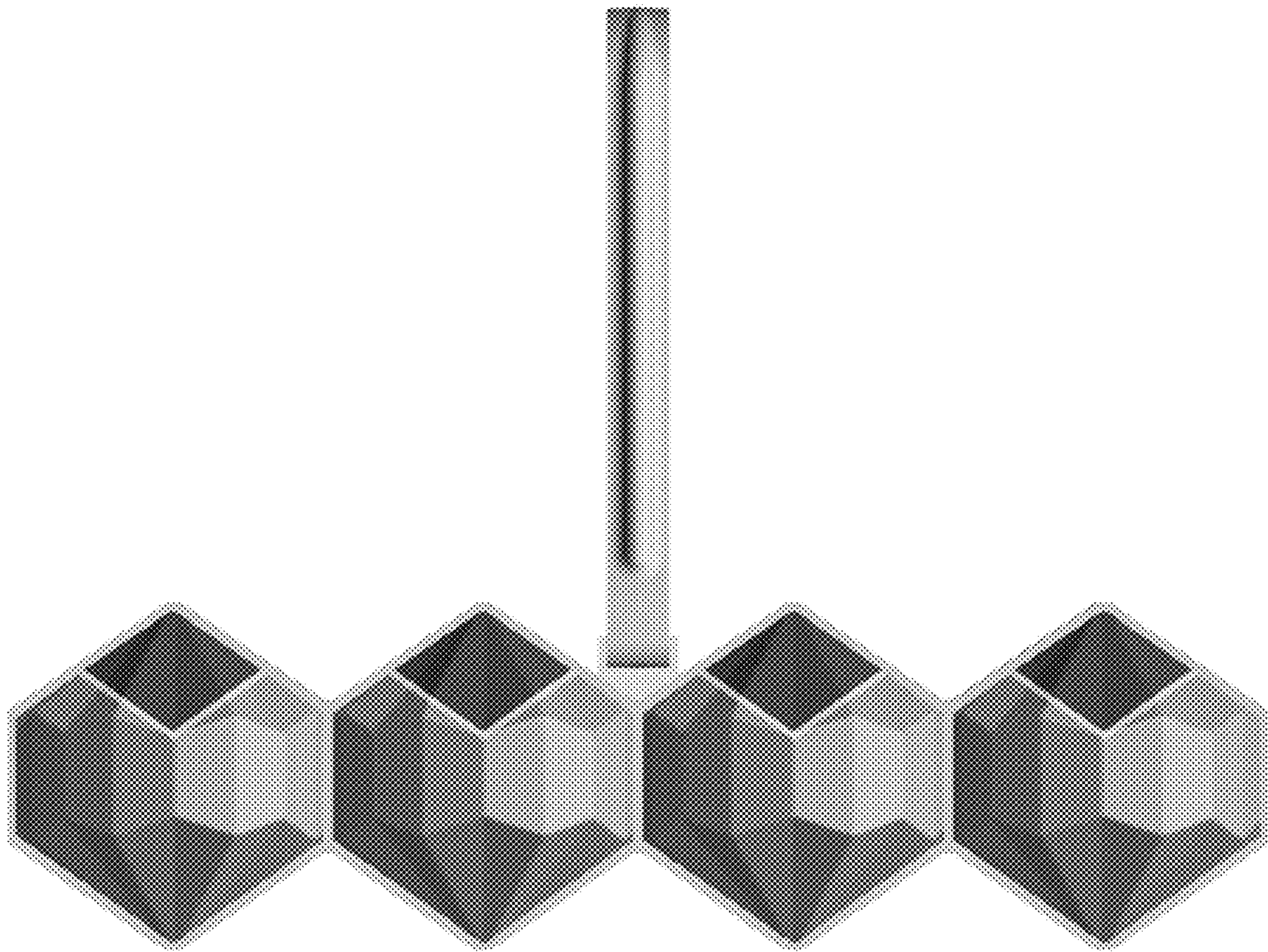

1.2

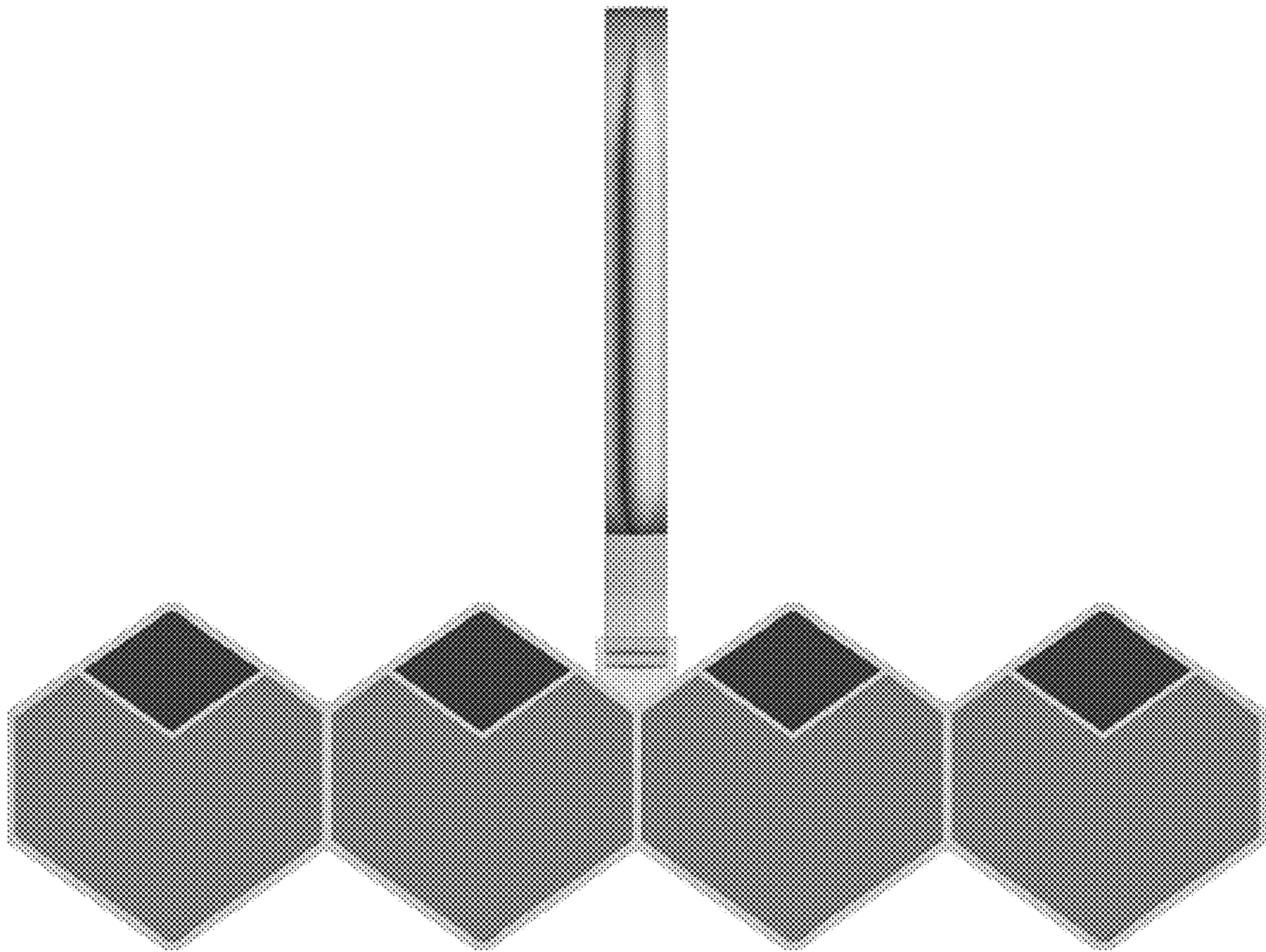

**1.3**

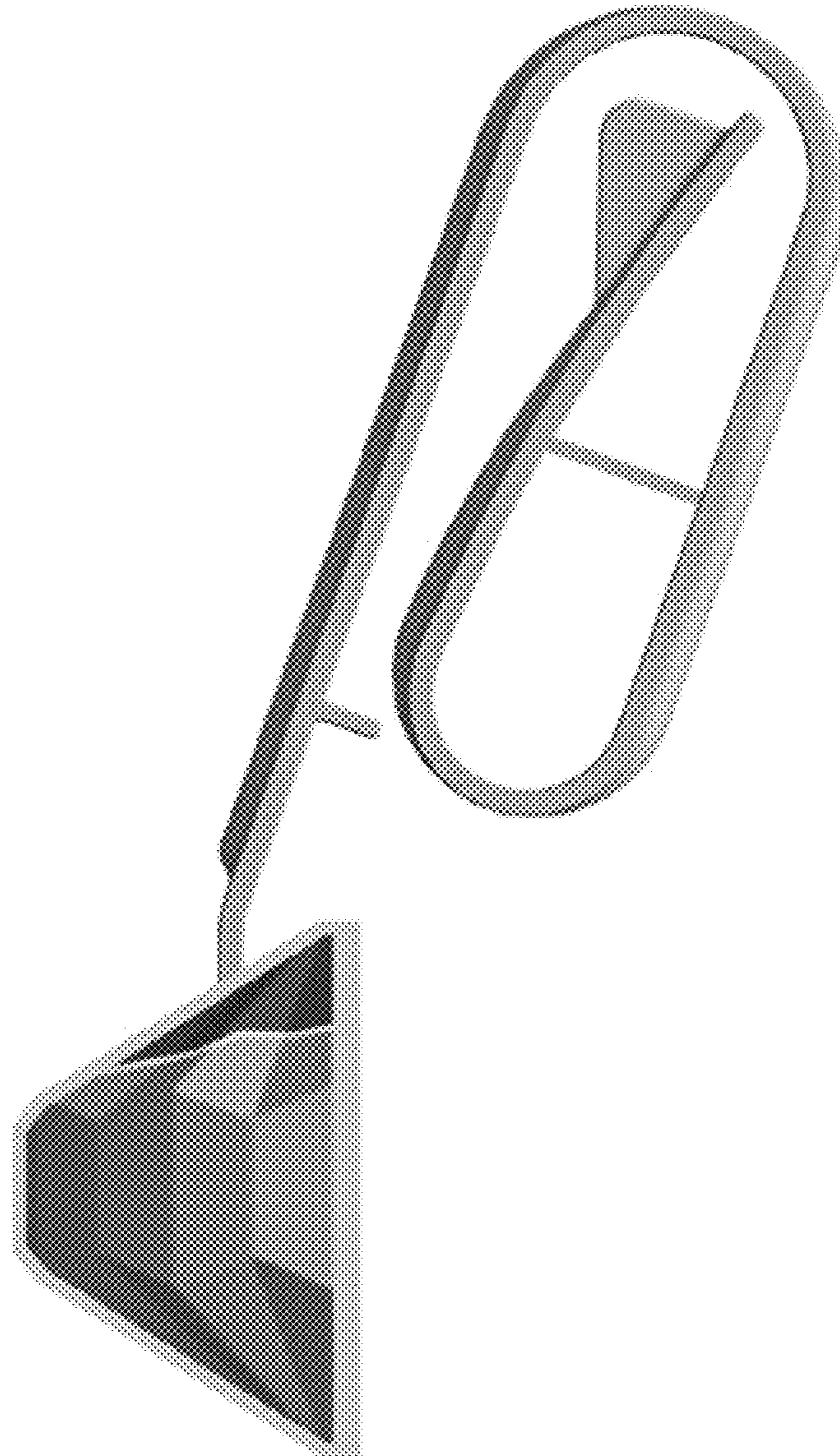

**1.4**

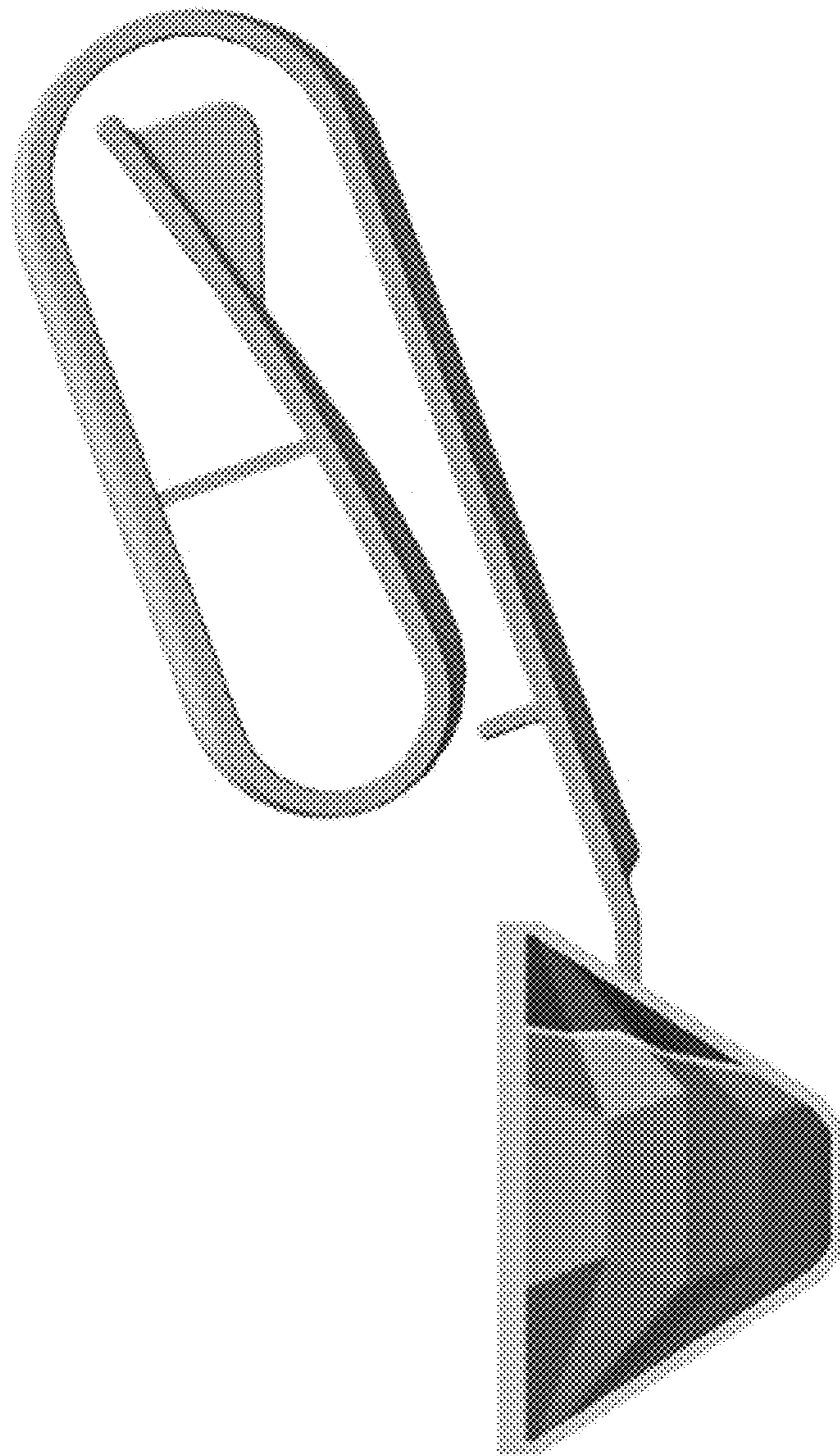

1.5

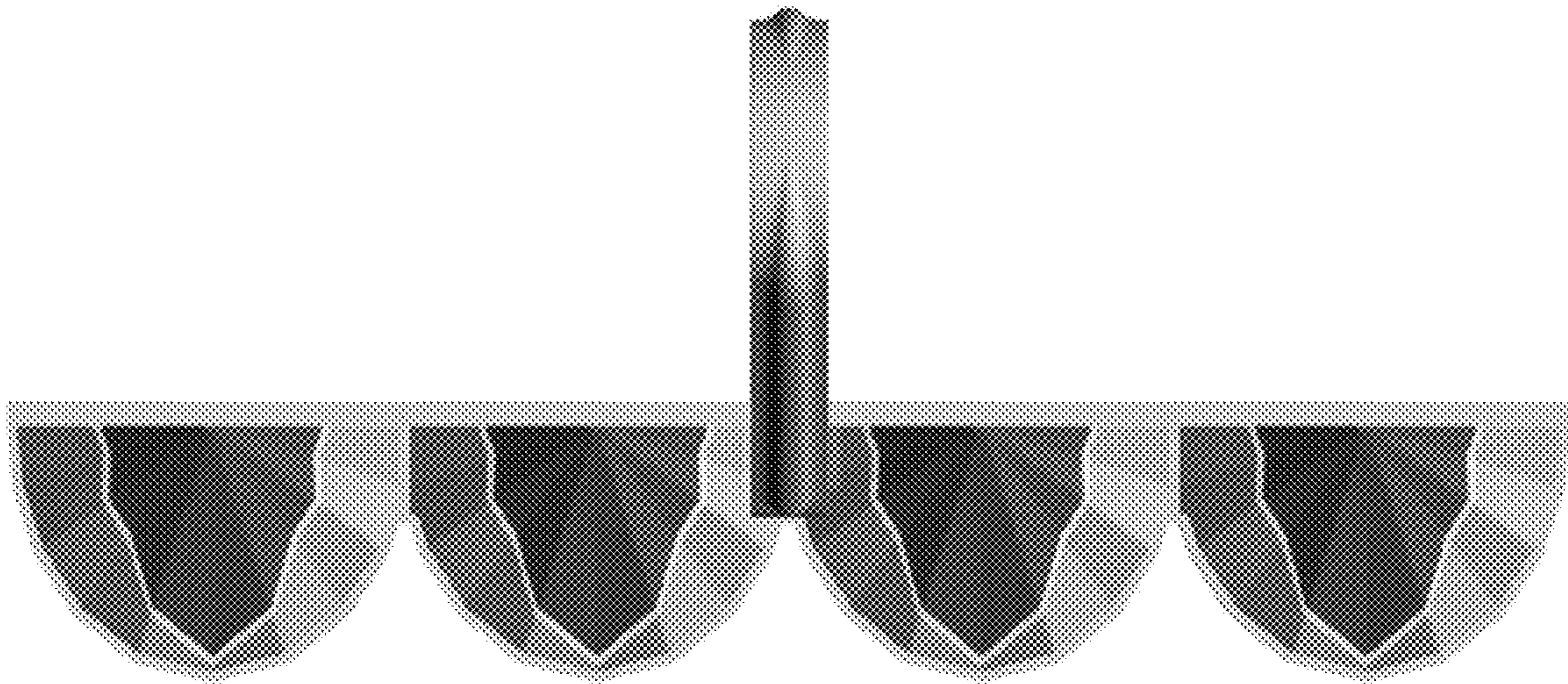

**1.6**

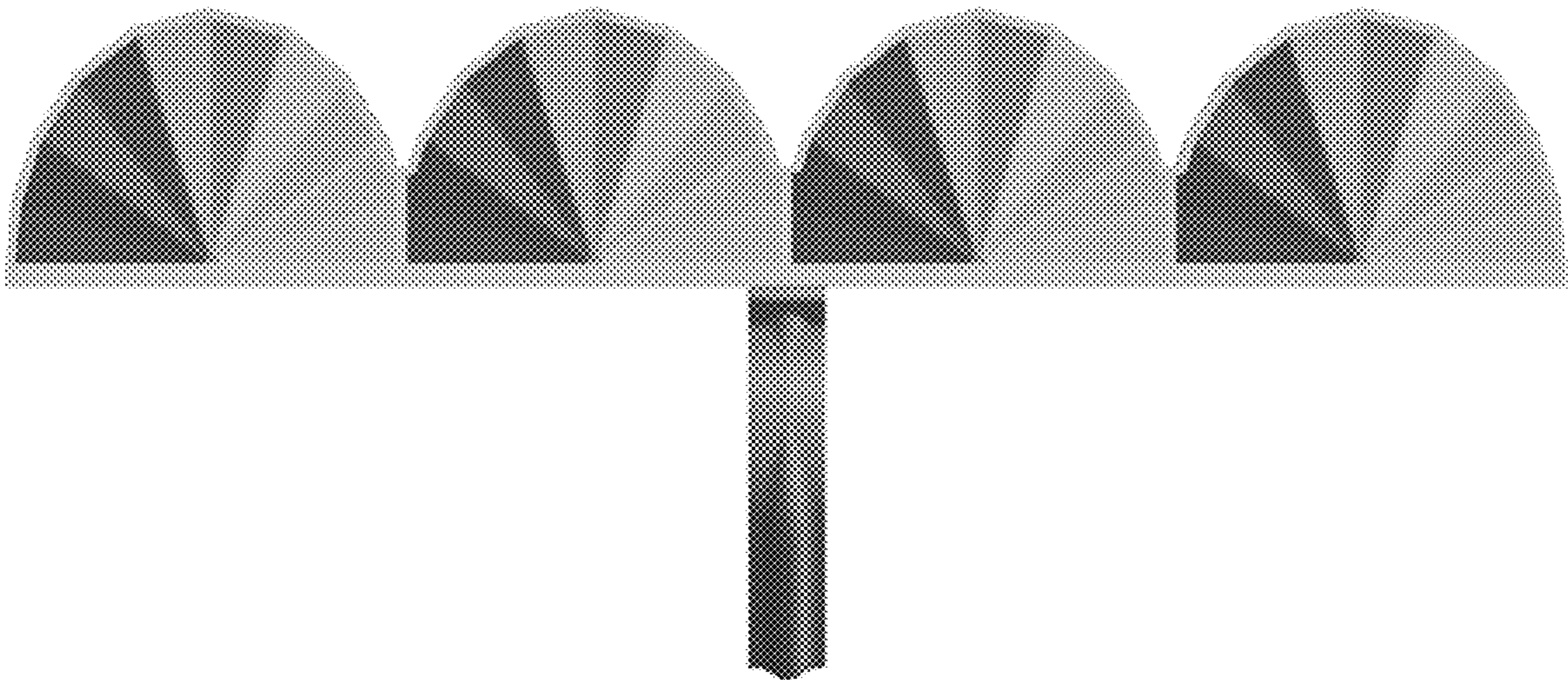



1.7



2.1

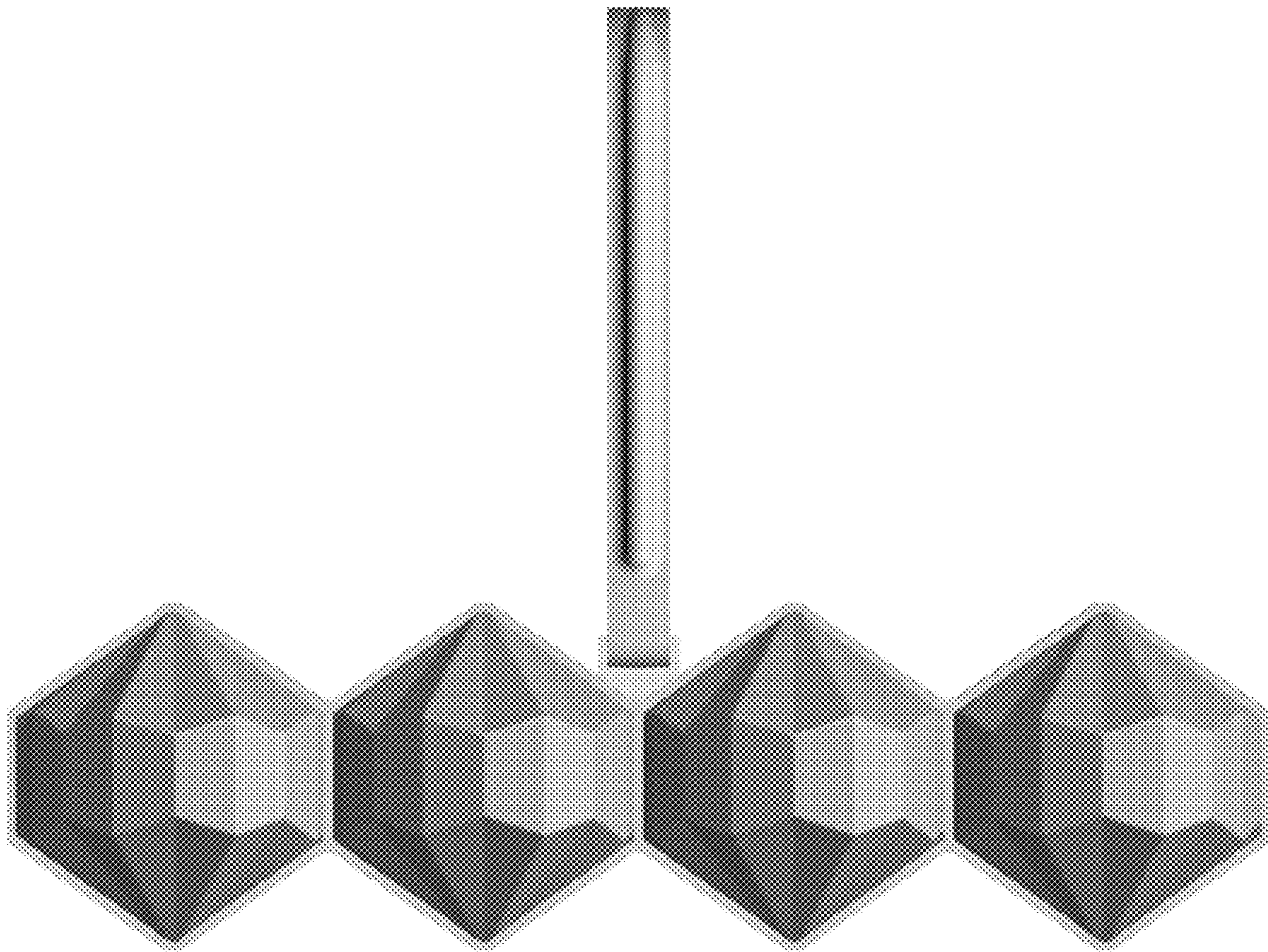

2.2

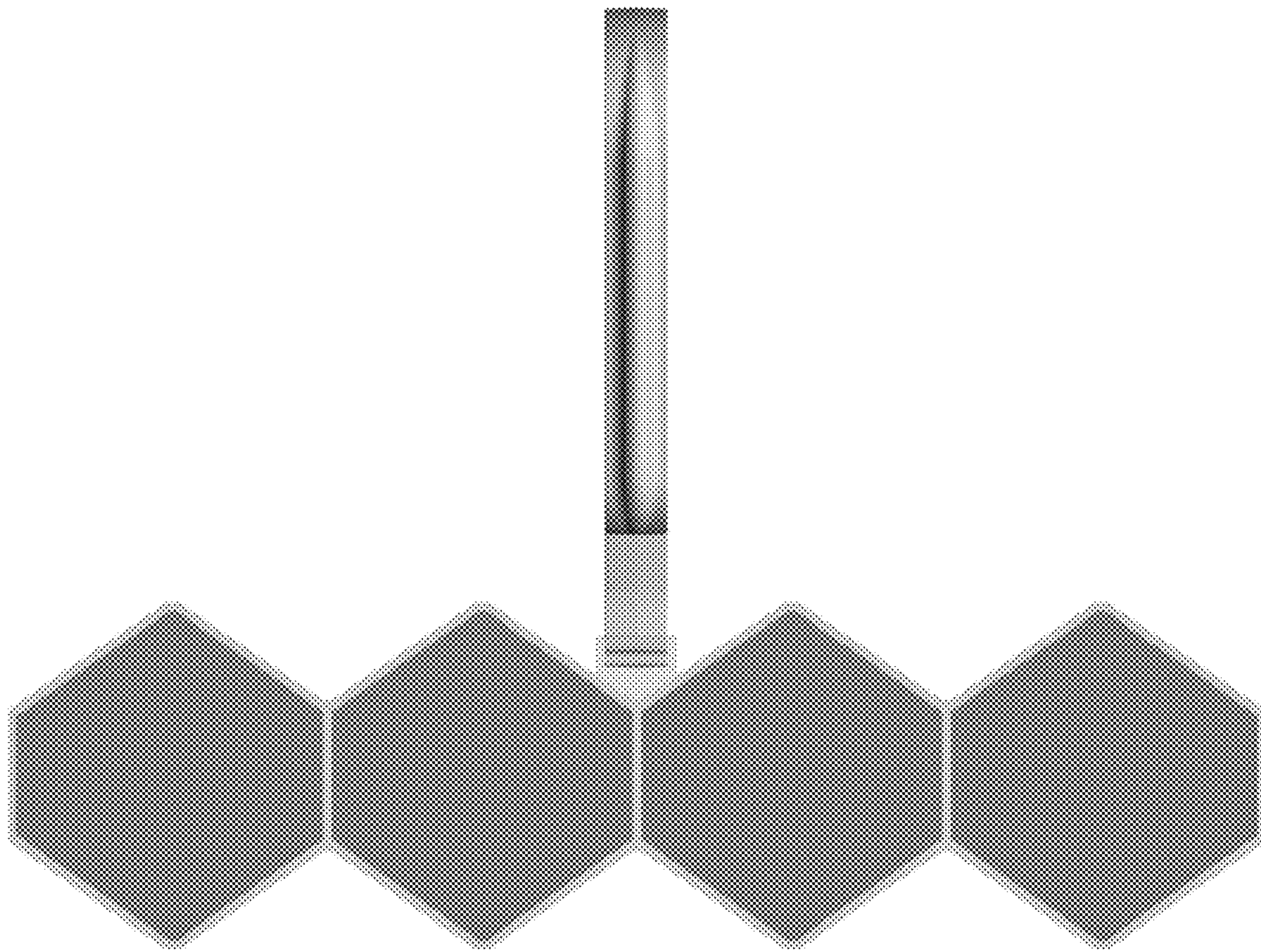

**2.3**

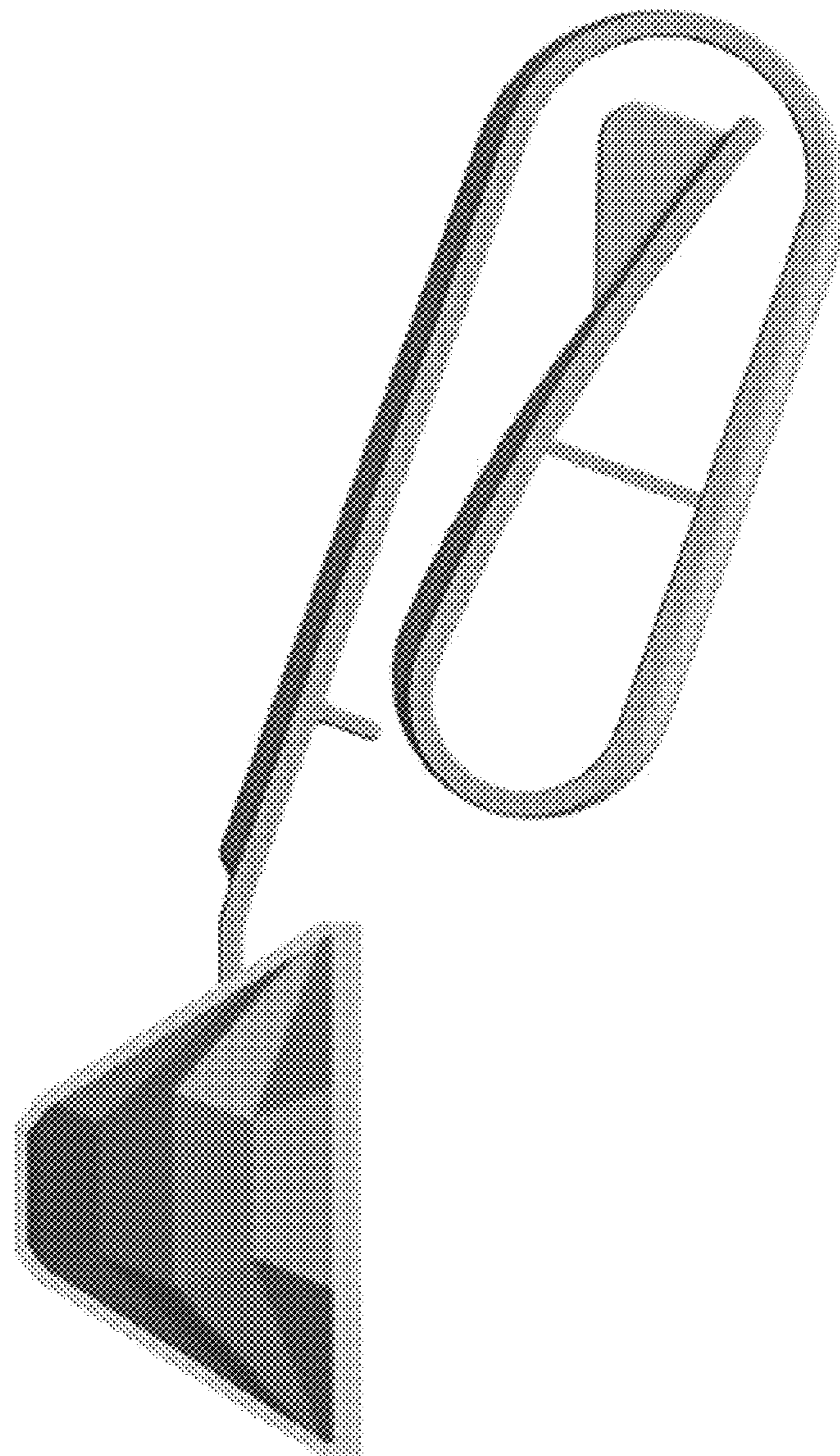

**2.4**

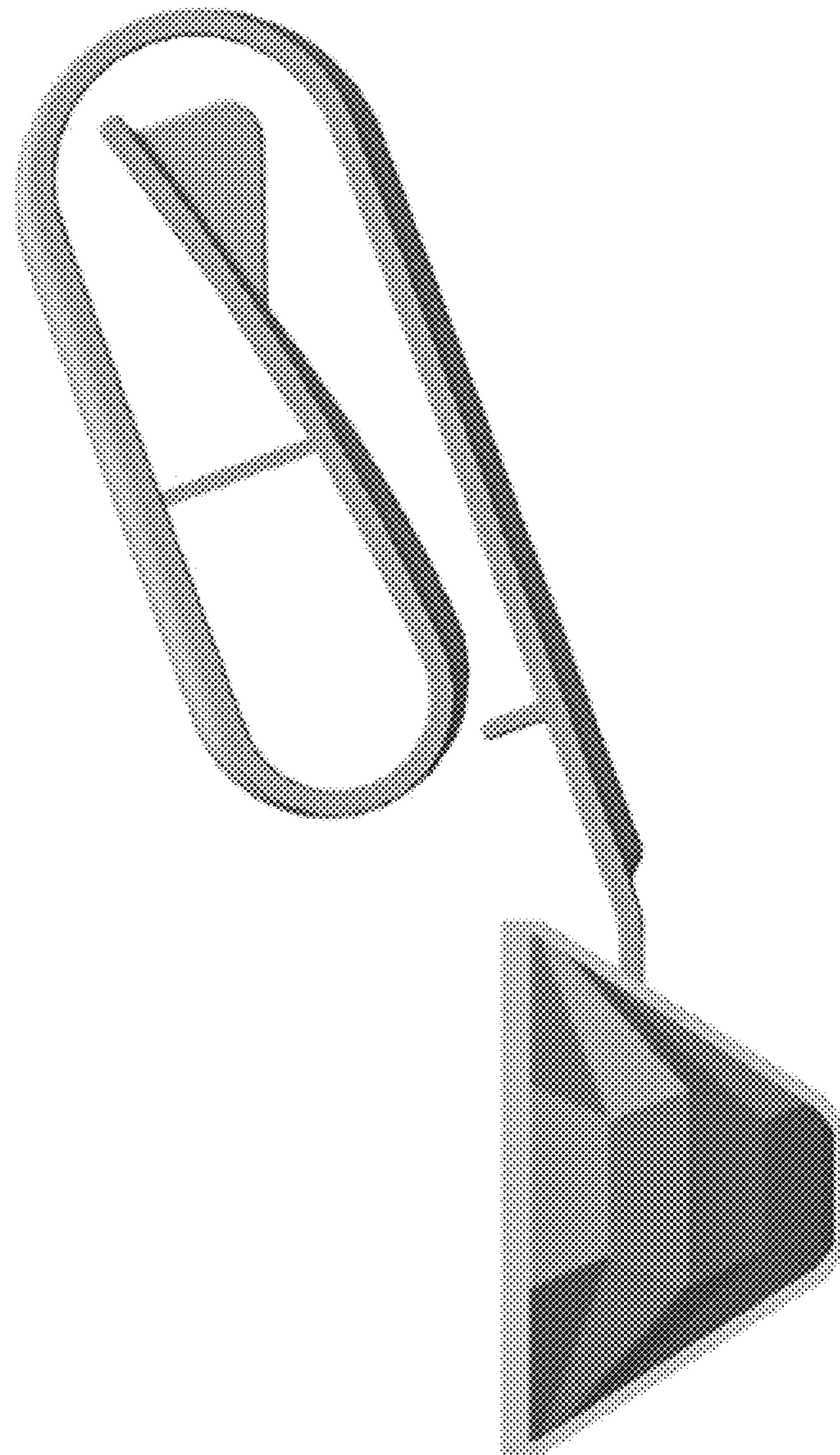

2.5

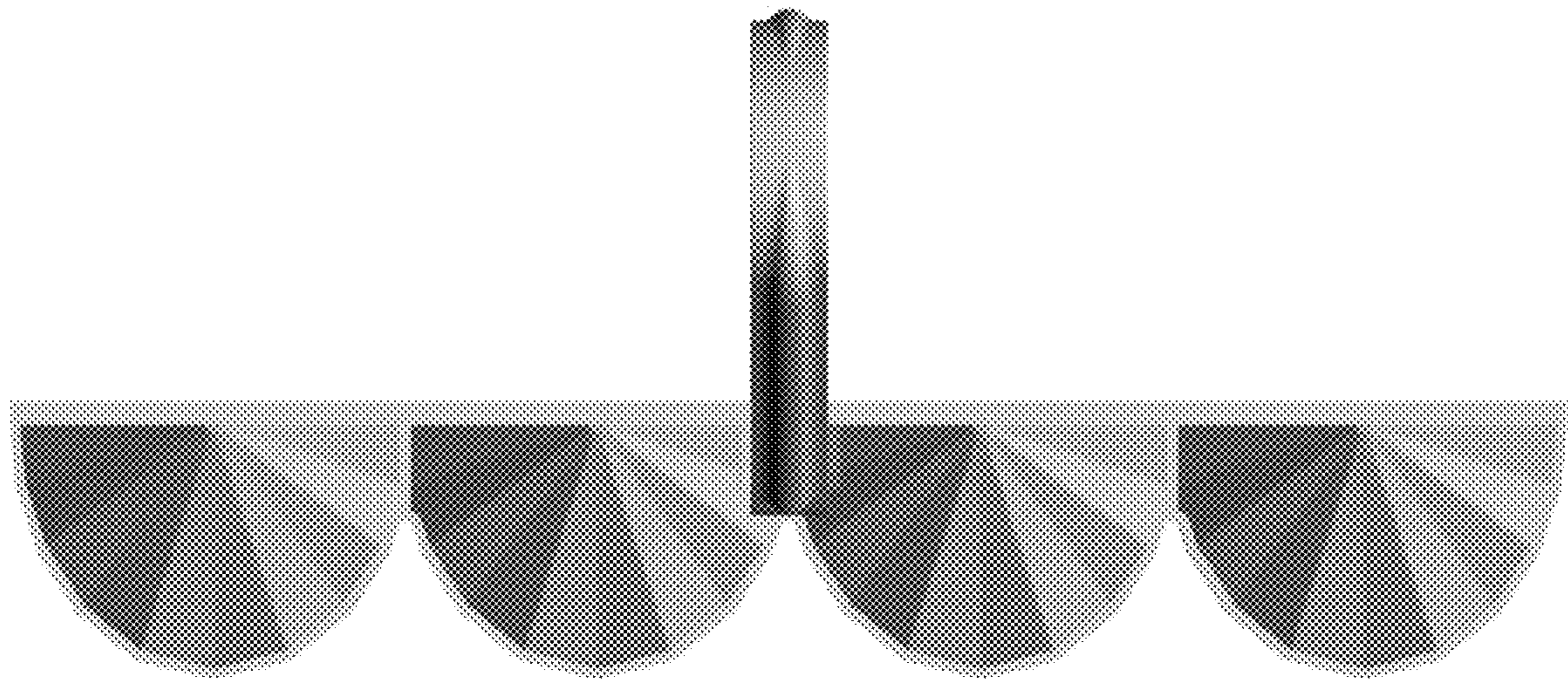

**2.6**

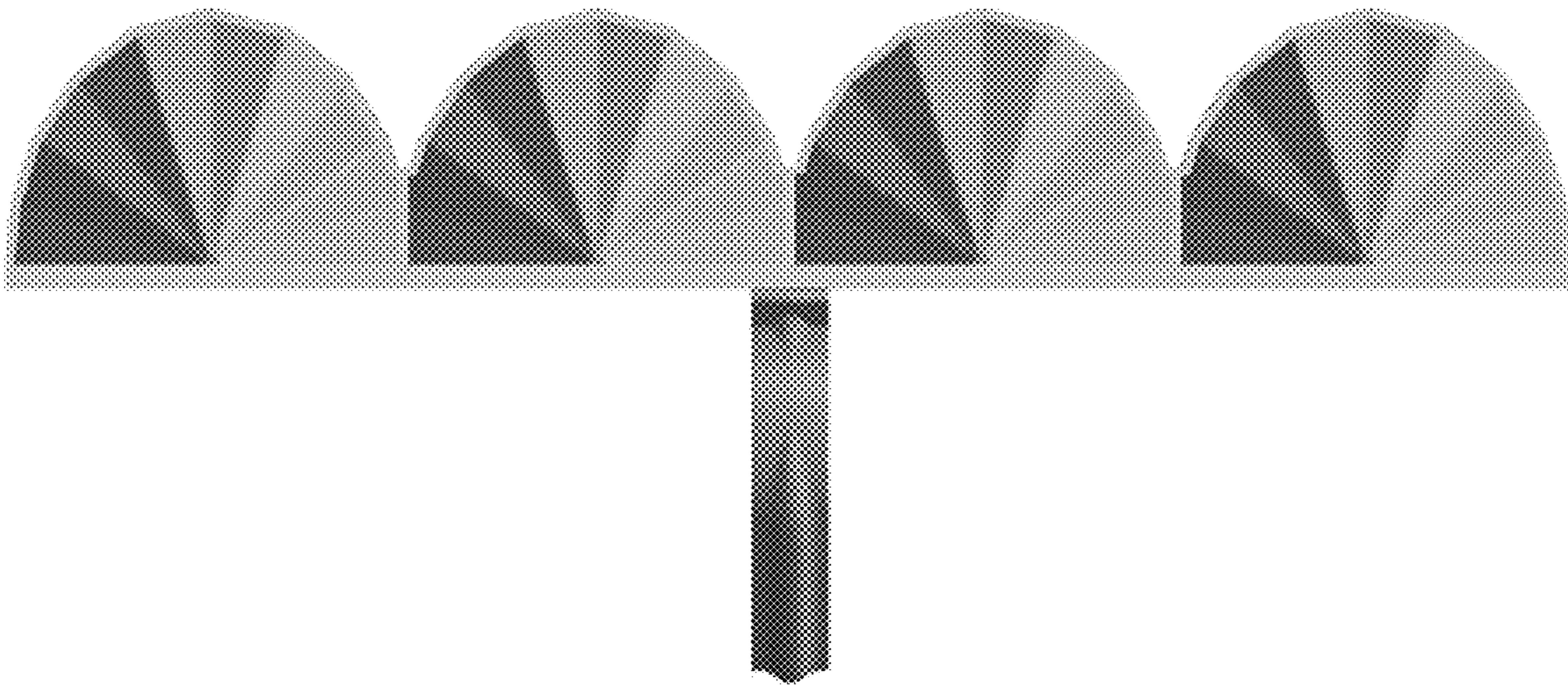

2.7





**3.1**

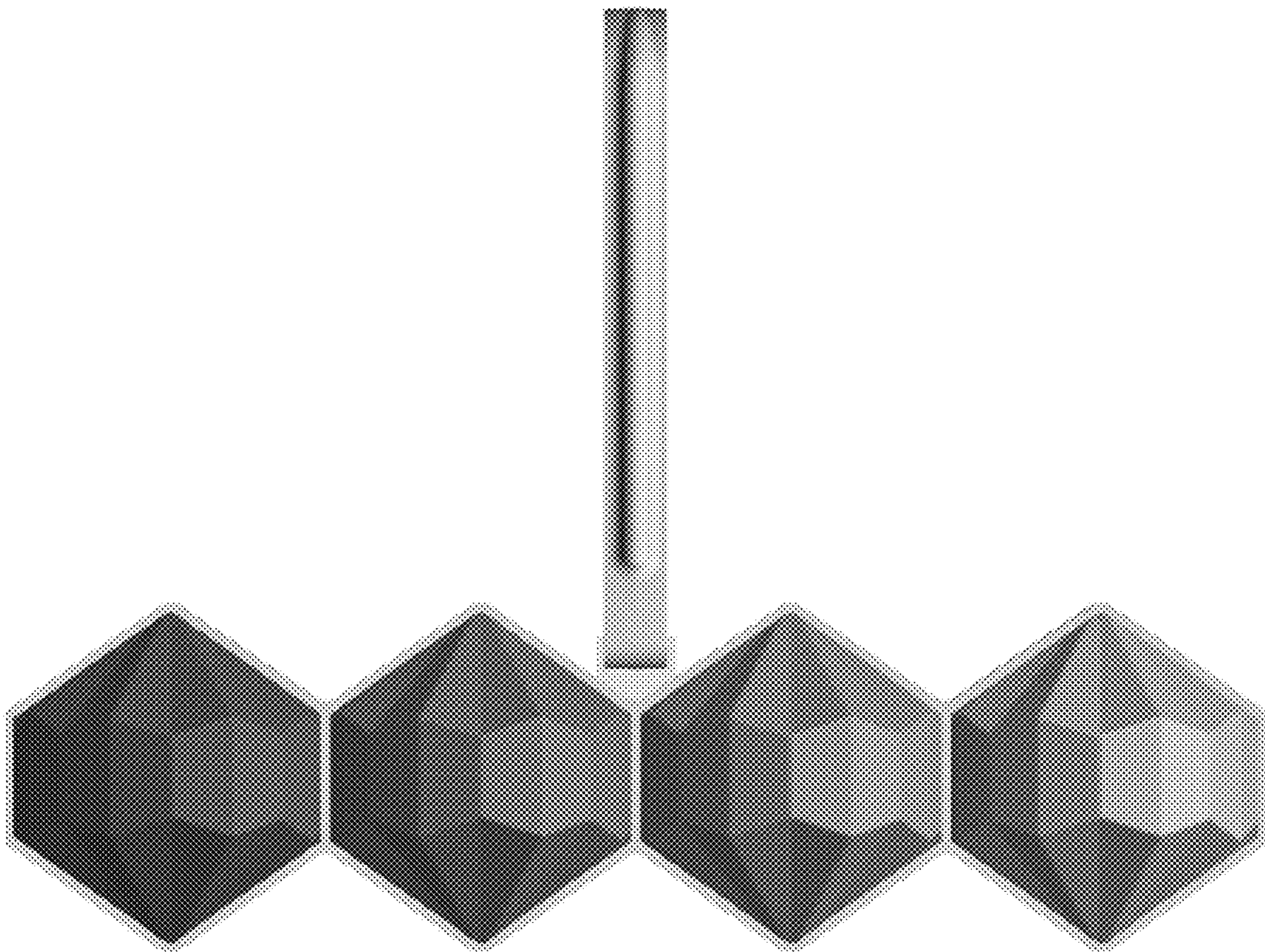

3.2

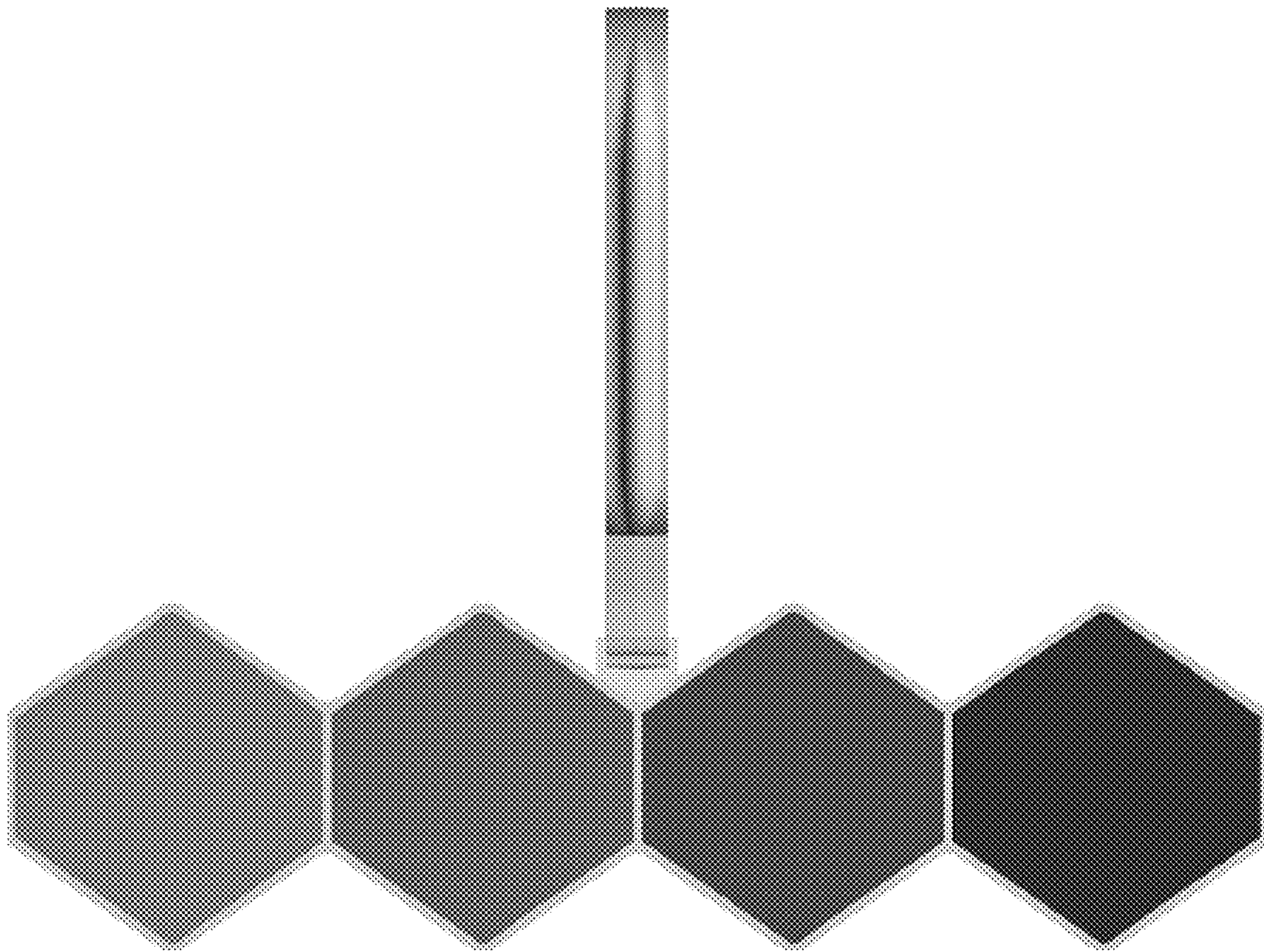

**3.3**

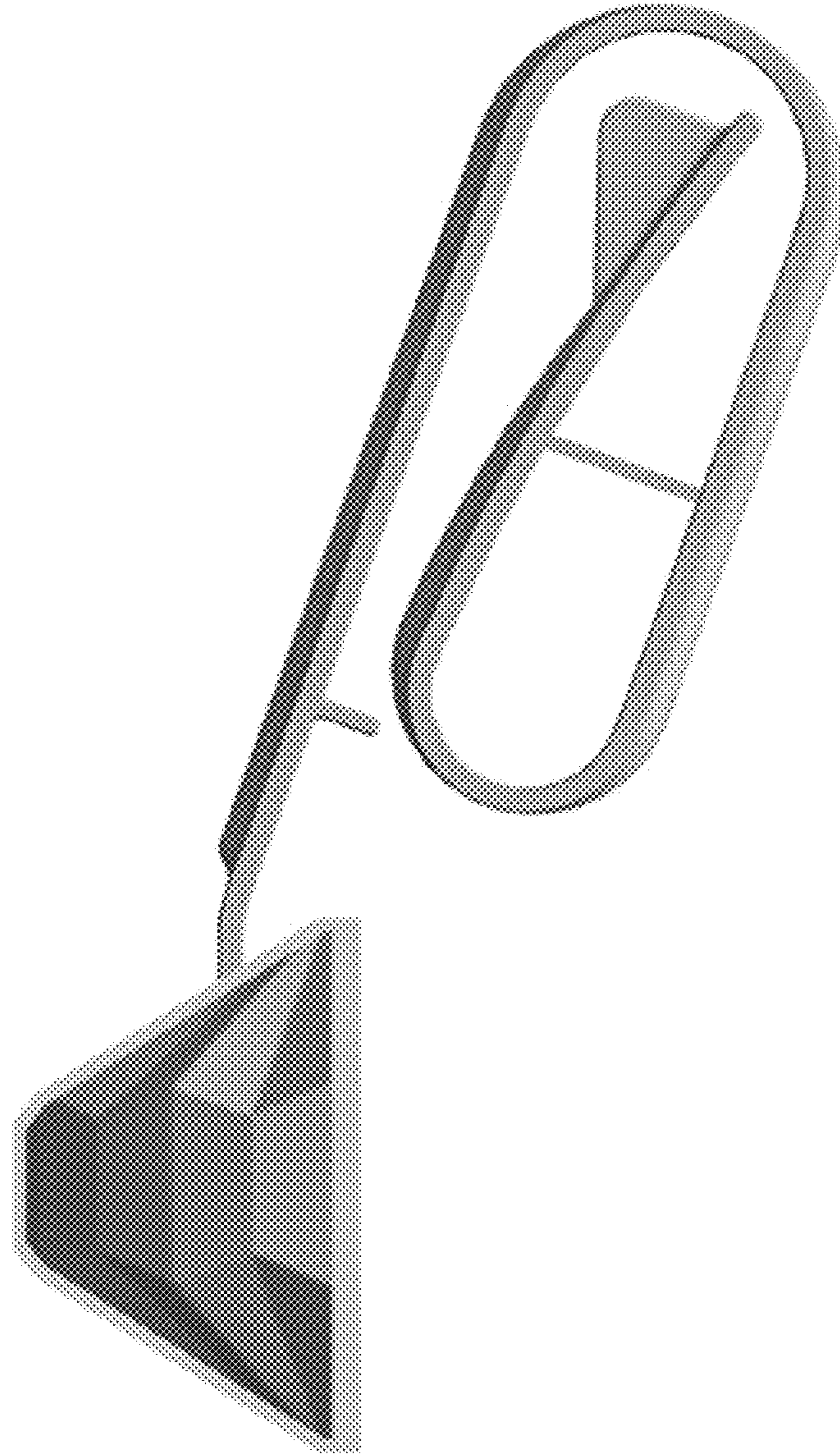

# 3.4

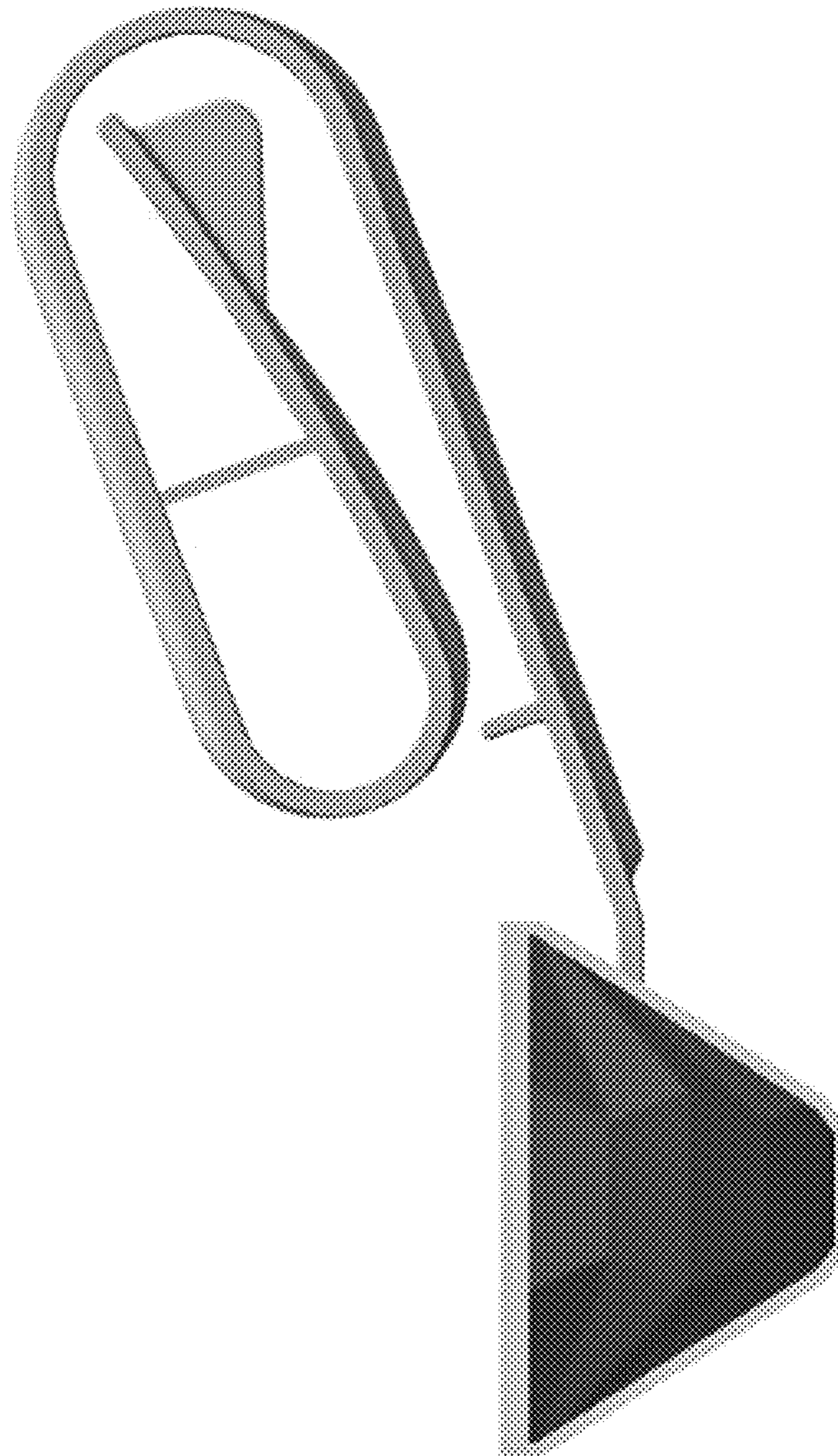

3.5

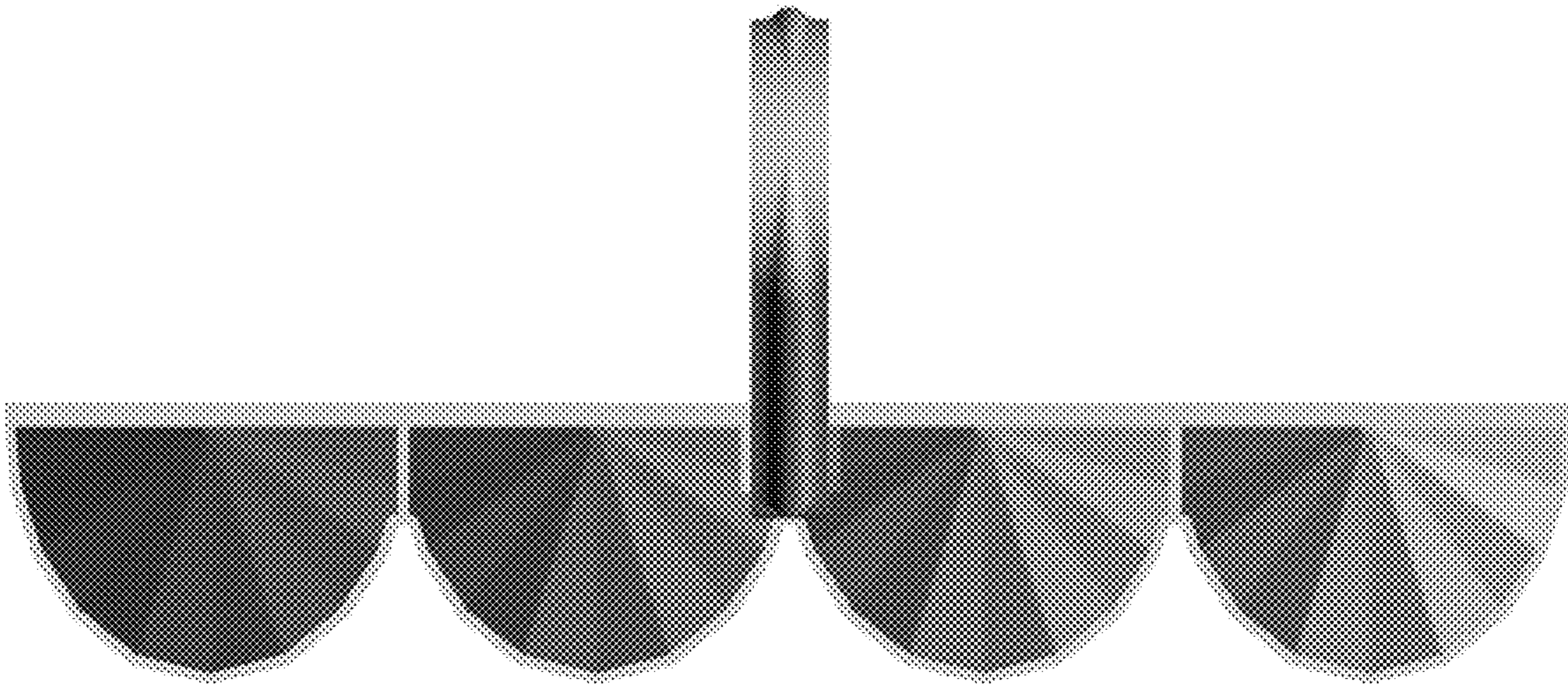

**3.6**

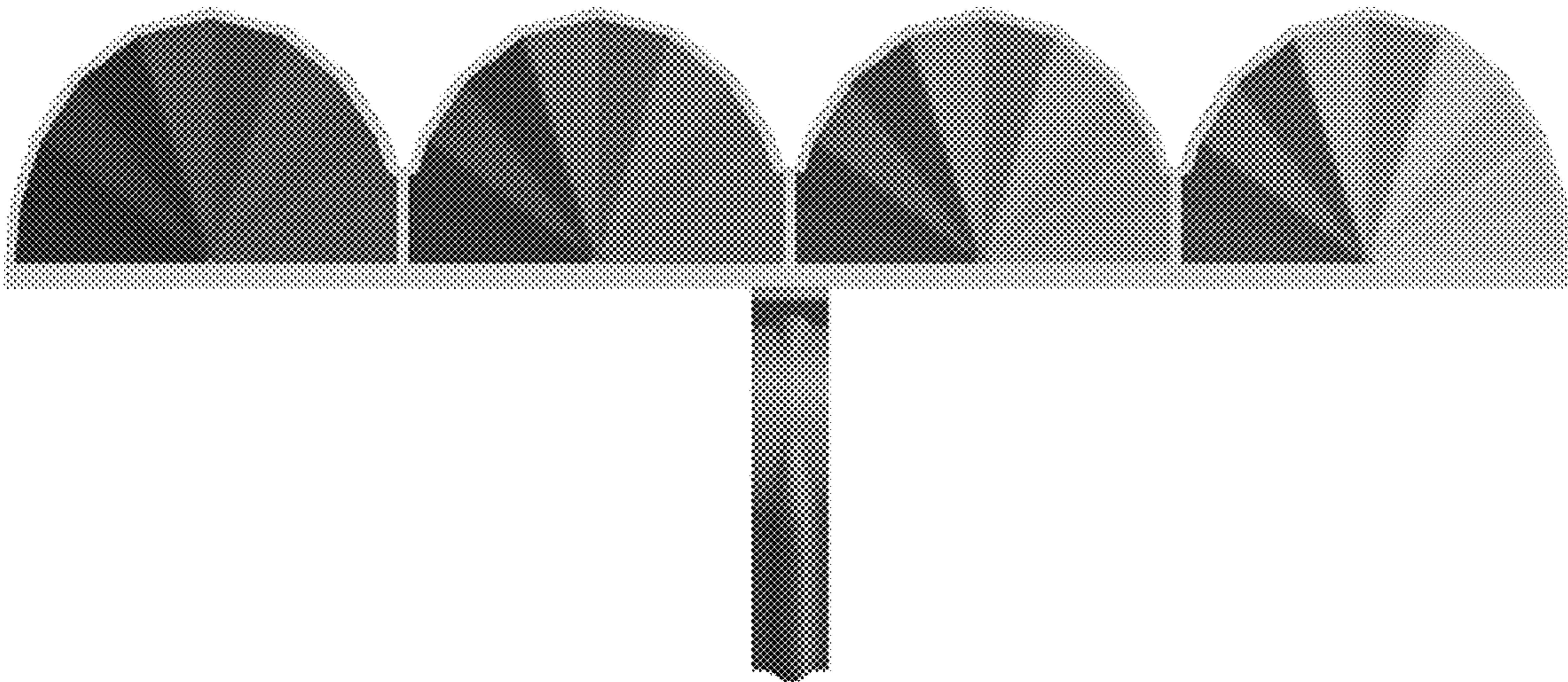

**3.7**



4.1

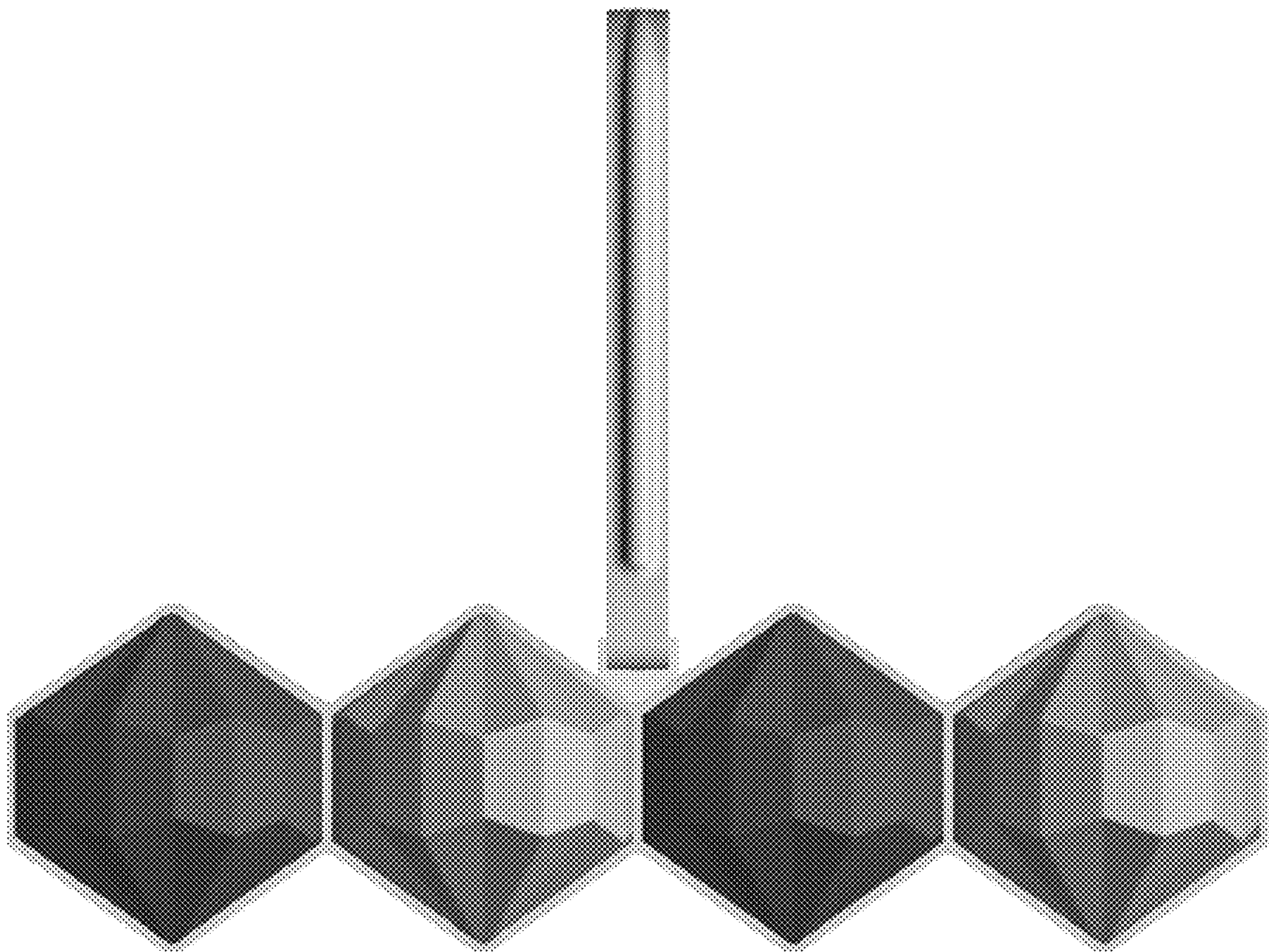



4.2

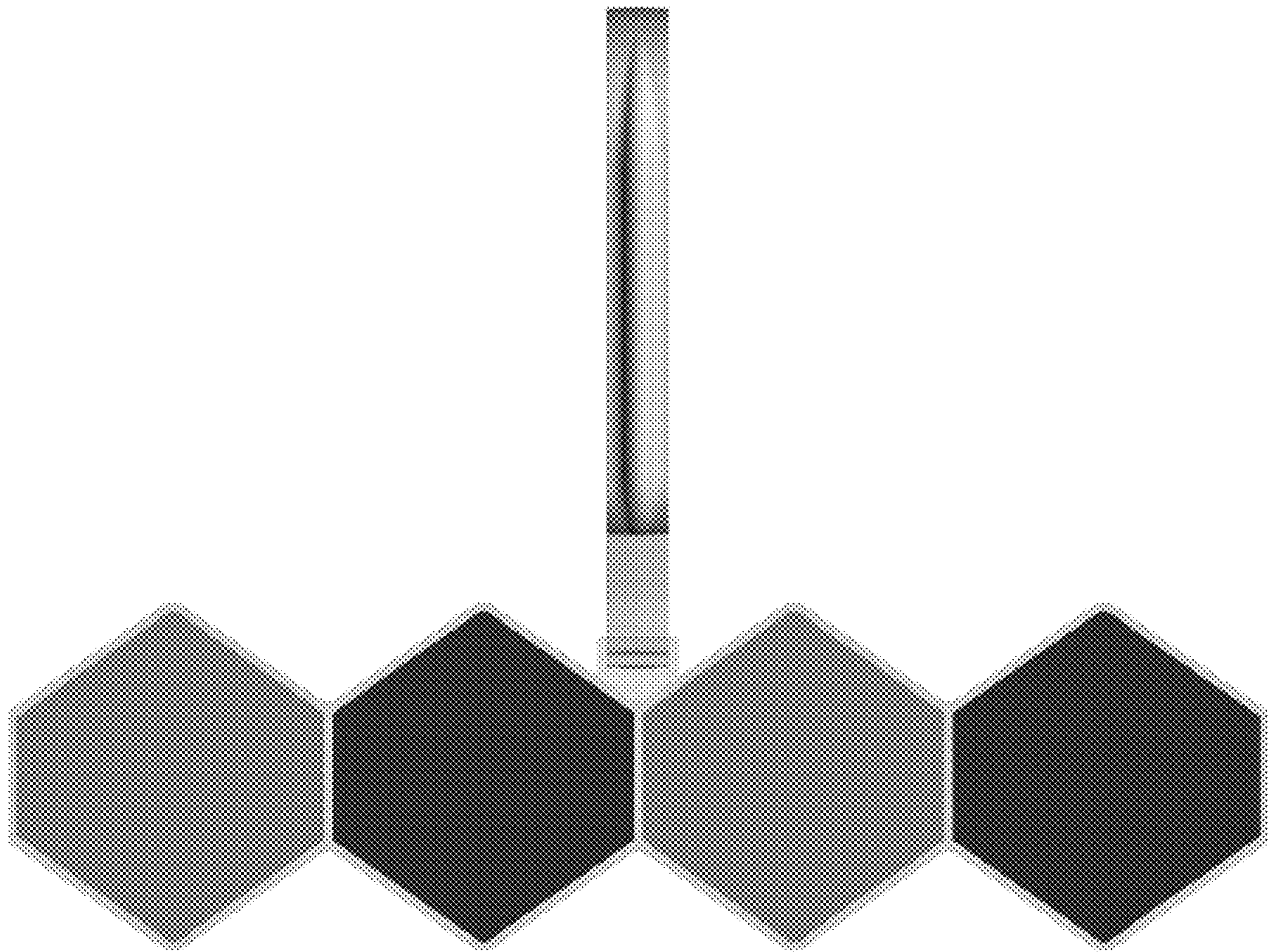

**4.3**

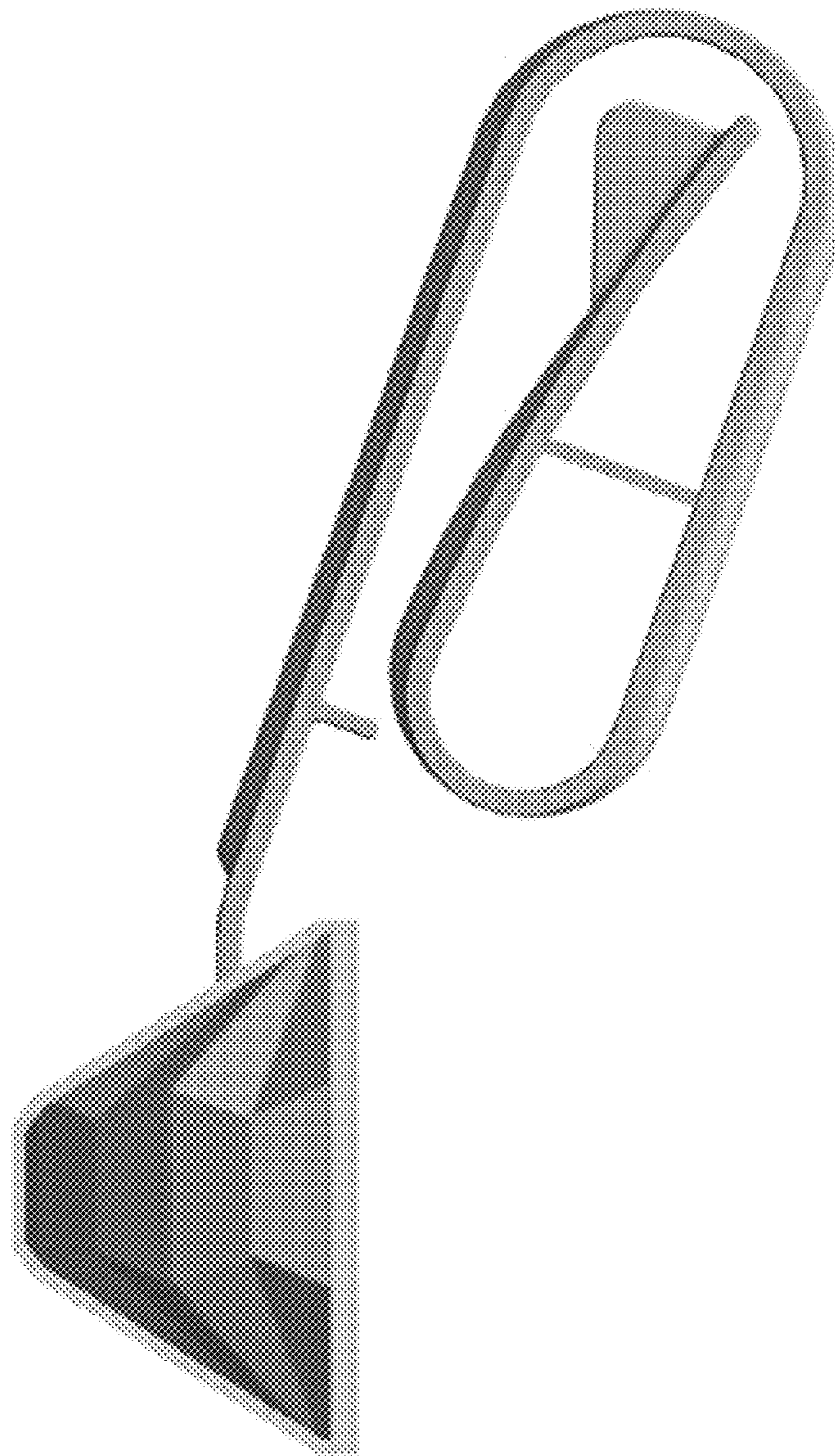

**4.4**

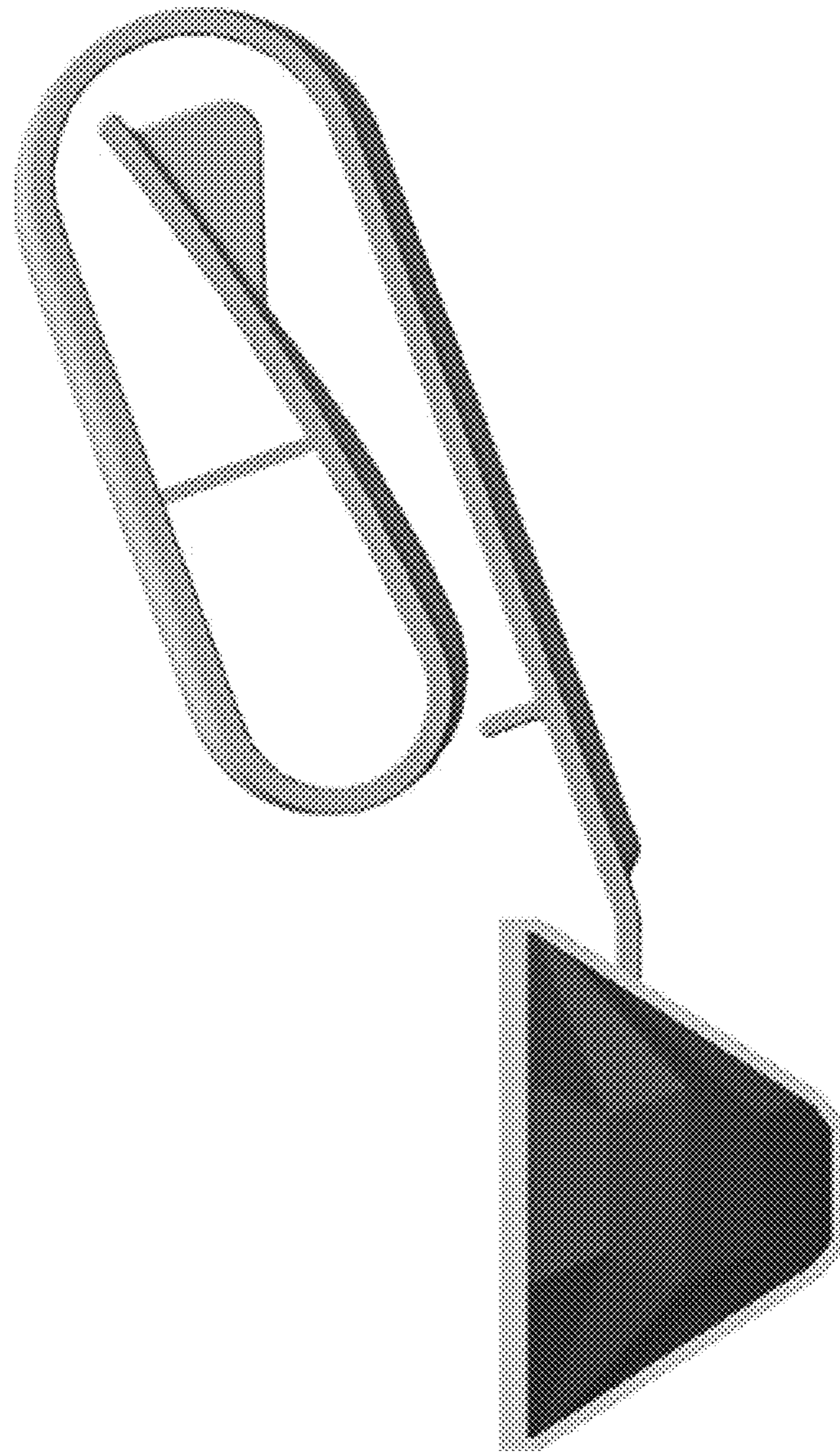

4.5

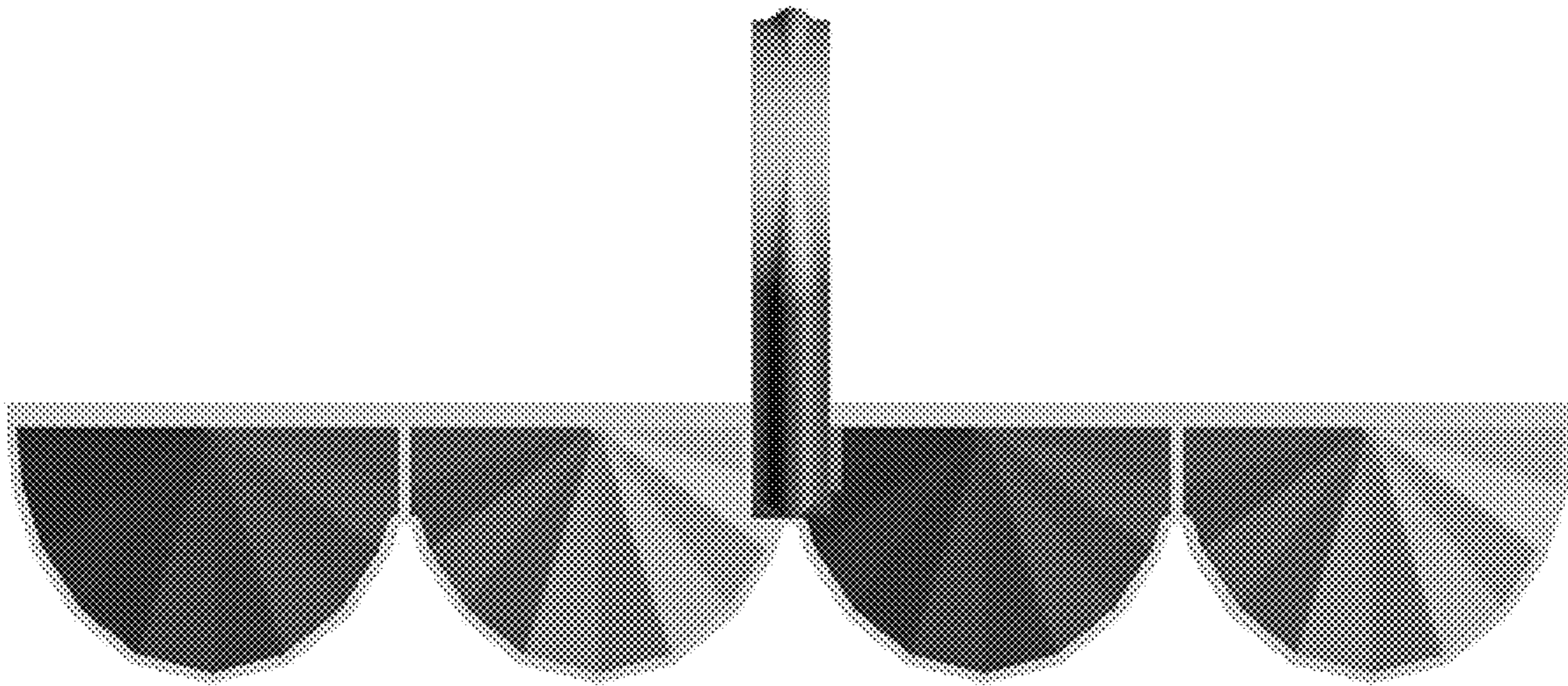

4.6

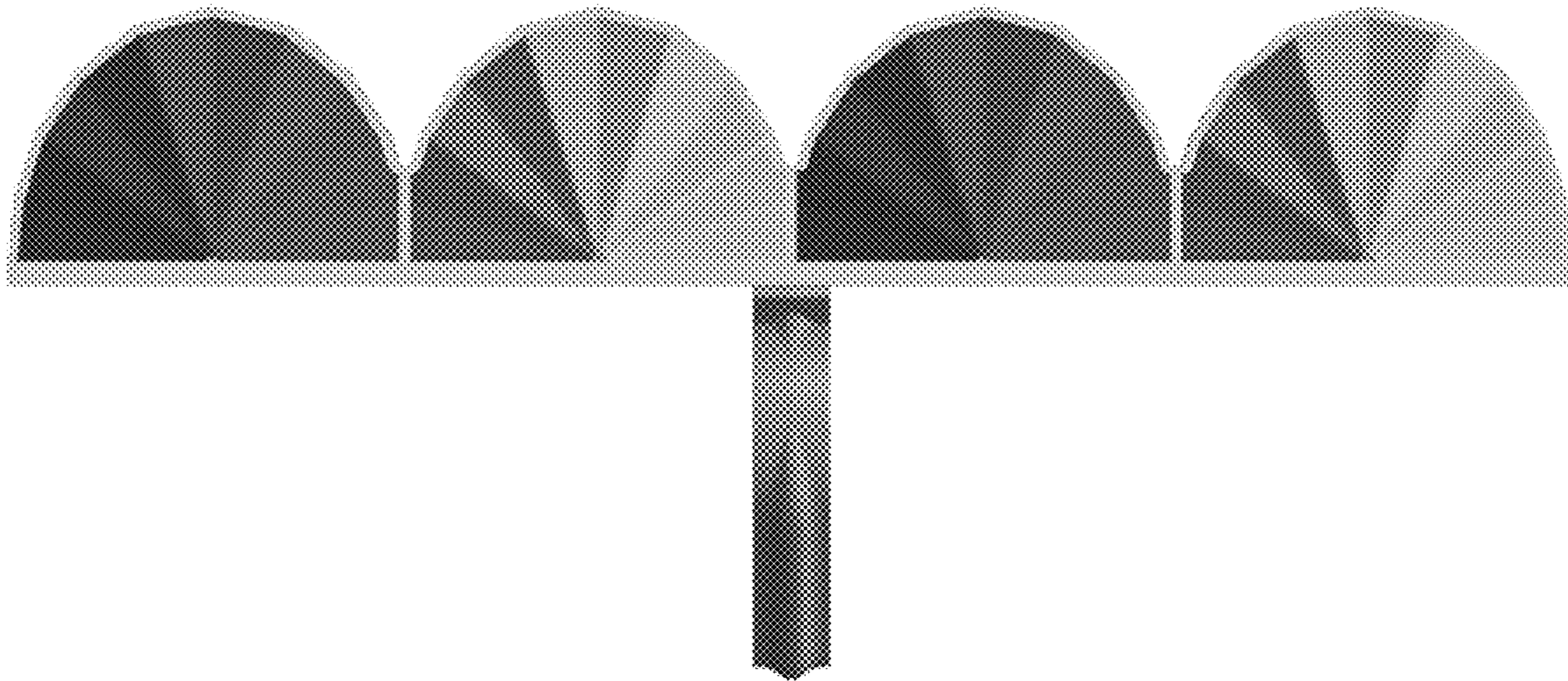

4.7

