



US00D823816S

(12) **United States Design Patent**
Azzola et al.

(10) **Patent No.: US D823,816 S**
(45) **Date of Patent: ** Jul. 24, 2018**

(54) **CIRCUIT BREAKER**

- (71) Applicant: **ABB S.p.A.**, Milan (IT)
- (72) Inventors: **Lucio Azzola**, Bergamo (IT); **Stefano Besana**, Terno d'Isola (IT)
- (73) Assignee: **ABB S.p.A.**, Milan (IT)
- (**) Term: **15 Years**
- (21) Appl. No.: **29/605,137**
- (22) Filed: **May 24, 2017**

Related U.S. Application Data

- (62) Division of application No. 29/532,336, filed on Jul. 6, 2015, now Pat. No. Des. 789,895, which is a
(Continued)

Foreign Application Priority Data

- Nov. 9, 2012 (EP) 002133363
- (51) **LOC (11) Cl.** **13-03**
- (52) **U.S. Cl.**
USPC **D13/160**
- (58) **Field of Classification Search**
USPC D13/101, 110, 123, 133, 158-162,
D13/182-184, 199; 200/43.14, 50.01,
(Continued)

References Cited

U.S. PATENT DOCUMENTS

- 4,728,757 A 3/1988 Buxton et al.
- D303,655 S 9/1989 Gonzales et al.
- (Continued)

FOREIGN PATENT DOCUMENTS

- WO DM/055273 4/2001

OTHER PUBLICATIONS

ABB SACE L.V. Emax. A system that's open to any solution.
604060/011, Jul. 1999.

(Continued)

Primary Examiner — Thomas Johannes
Assistant Examiner — Shawn T Gingrich
(74) *Attorney, Agent, or Firm* — Polsinelli PC

(57) **CLAIM**

The ornamental design for circuit breaker, as shown and described.

DESCRIPTION

FIG. 1 is a isometric view of a first embodiment of the new design;
 FIG. 2 is a front view thereof;
 FIG. 3 is a rear view thereof;
 FIG. 4 is a left view thereof;
 FIG. 5 is a right view thereof;
 FIG. 6 is a top view thereof;
 FIG. 7 is a bottom view thereof;
 FIG. 8 is a isometric view of a second embodiment of the new design;
 FIG. 9 is a front view thereof;
 FIG. 10 is a rear view thereof;
 FIG. 11 is a left view thereof;
 FIG. 12 is a right view thereof;
 FIG. 13 is a top view thereof;
 FIG. 14 is a bottom view thereof;
 FIG. 15 is a isometric view of a third embodiment of the new design;
 FIG. 16 is a front view thereof;
 FIG. 17 is a rear view thereof;
 FIG. 18 is a left view thereof;
 FIG. 19 is a right view thereof;
 FIG. 20 is a top view thereof;
 FIG. 21 is a bottom view thereof;
 FIG. 22 is a isometric view of a fourth embodiment of the new design;
 FIG. 23 is a front view thereof;
 FIG. 24 is a rear view thereof;

(Continued)

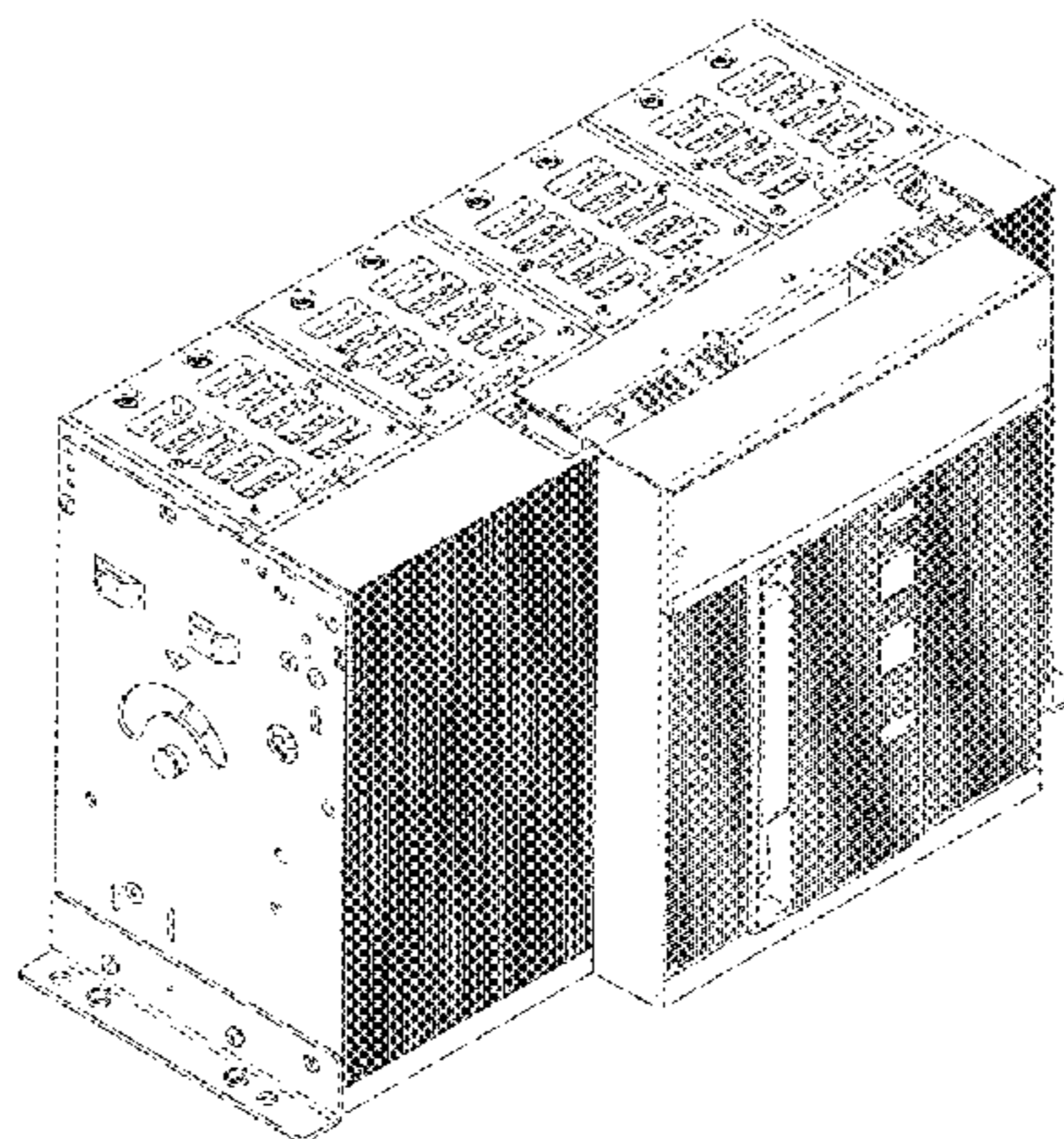
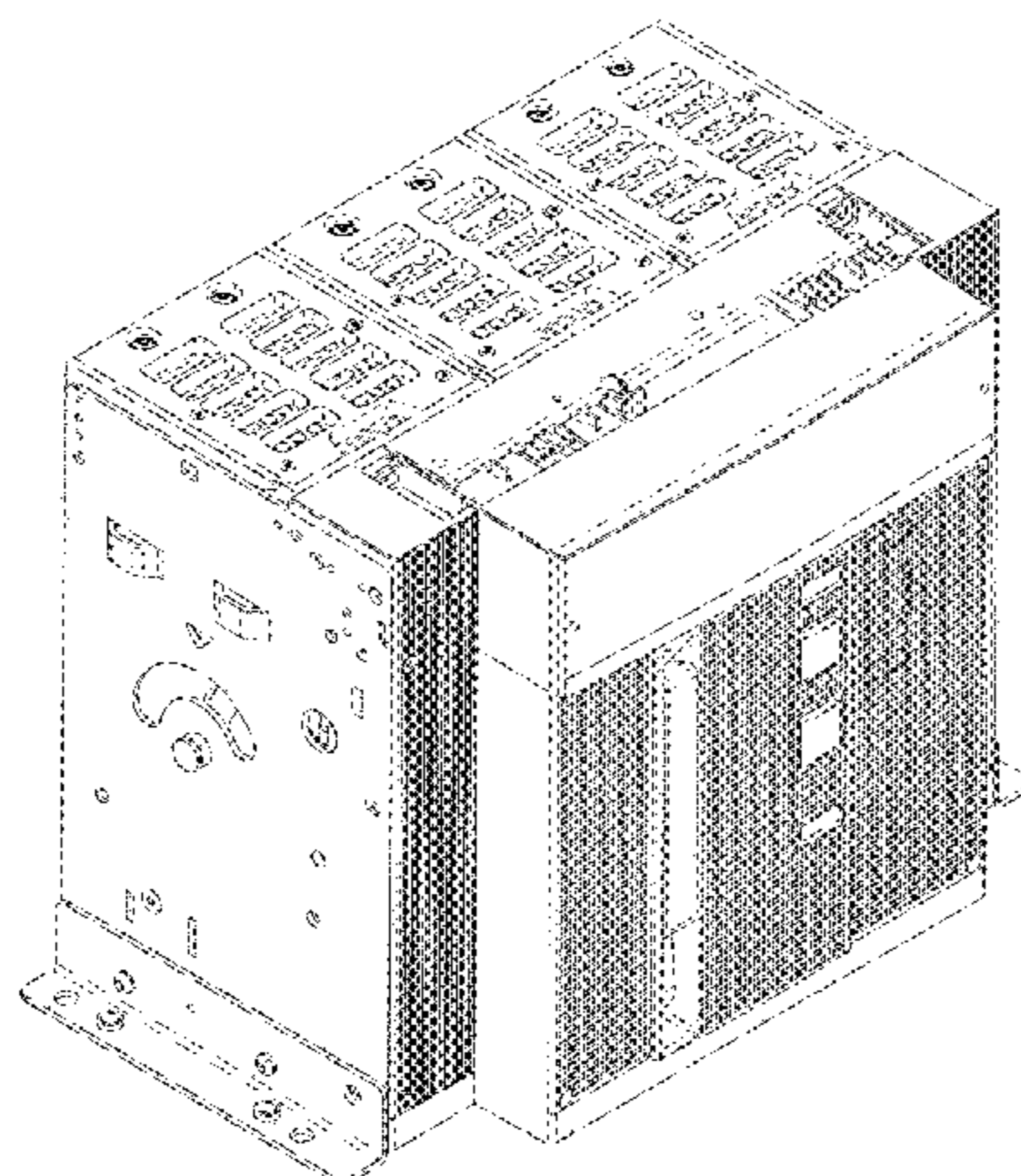

FIG. 25 is a left view thereof;
 FIG. 26 is a right view thereof;
 FIG. 27 is a top view thereof; and,
 FIG. 28 is a bottom view thereof.
 The broken line portion of the figure drawings is included to show unclaimed subject matter only and forms no part of the claimed design.

1 Claim, 28 Drawing Sheets

Related U.S. Application Data

division of application No. 29/454,376, filed on May 9, 2013, now Pat. No. Des. 752,524.

(58) **Field of Classification Search**

USPC 200/50.21-50.23, 293; 361/42, 44, 50, 361/71, 115, 608, 63, 4
 CPC G01R 31/025; G01R 19/145; H01H 71/08; H01H 71/04; H01H 83/226; H01H 9/283; H01H 2071/0278; H01H 71/0271; H01H 71/1045; H01H 71/1054; H01H 71/12; H01H 71/123; H01H 71/16; H01H 83/04; H01H 9/0264; H01H 9/342; H01R 4/36; H01R 13/447; H01R 13/641; H01R 9/18; H01R 13/514; H01R 13/639; H01R 33/765; H01R 33/7664; H01R 43/20; H02B 11/133; Y02B 70/3241; Y02B 90/224; Y02E 10/725; Y04S 20/14; Y04S 20/227

See application file for complete search history.

(56) **References Cited**

U.S. PATENT DOCUMENTS

D310,822 S	9/1990	Danek
D315,333 S	3/1991	Barbier et al.
D318,460 S	7/1991	Heath et al.
D318,461 S	7/1991	Hasegawa et al.
D319,627 S	9/1991	Smith et al.
D325,727 S	4/1992	Murata et al.
D334,174 S	3/1993	Hosogai et al.
5,296,664 A	3/1994	Crookston et al.
D347,623 S	6/1994	Suzuki et al.
5,362,933 A	11/1994	Kutsche et al.
D359,948 S	7/1995	Merlin
5,587,570 A	12/1996	Kelaita, Jr. et al.
5,610,375 A	3/1997	Sinhomez
D378,914 S	4/1997	Smith et al.
5,717,178 A	2/1998	Turner et al.
D402,267 S	12/1998	M'Sadoques
5,902,973 A	5/1999	Ramey et al.
5,906,271 A	5/1999	Casionguay et al.
6,008,459 A	12/1999	Faber et al.
D425,870 S	5/2000	Torrez
6,078,017 A	6/2000	Blessitt et al.
6,177,641 B1	1/2001	Morel et al.
6,184,483 B1	2/2001	Coudert et al.
D442,146 S	5/2001	Greenberg et al.
6,361,848 B1	3/2002	Katsube et al.

6,388,867 B1	5/2002	Rakus et al.
6,445,559 B1	9/2002	Phillips et al.
6,489,577 B2	12/2002	Kurata
6,512,433 B1	1/2003	Bouchard et al.
D498,464 S	11/2004	Kim
D499,700 S	12/2004	Raabe et al.
D499,701 S	12/2004	Kim
D506,185 S	6/2005	Kim
D511,502 S	11/2005	Kim
7,064,283 B2	6/2006	Deylitz et al.
7,141,747 B2	11/2006	Dahl et al.
D535,626 S	1/2007	Azzola et al.
D547,730 S	7/2007	Azzola et al.
D551,629 S	9/2007	Azzola et al.
D562,777 S	2/2008	Azzola et al.
D576,111 S	9/2008	Azzola et al.
D585,839 S	2/2009	Azzola et al.
D587,658 S	3/2009	Azzola et al.
D593,040 S	5/2009	Frassinetti et al.
D593,506 S	6/2009	Azzola et al.
D599,301 S	9/2009	Azzola et al.
D600,214 S	9/2009	Detemple et al.
D606,026 S	12/2009	Azzola et al.
D610,552 S	2/2010	Azzola et al.
D611,002 S	3/2010	Azzola et al.
D616,832 S	6/2010	Corteel
D633,446 S	3/2011	Besana et al.
D639,252 S	6/2011	Azzola et al.
D641,710 S	7/2011	Azzola et al.
D641,711 S	7/2011	Azzola et al.
D659,105 S	5/2012	Azzola et al.
D660,805 S	5/2012	Azzola et al.
D682,794 S	5/2013	Biller et al.
D687,387 S	8/2013	Besana et al.
D704,149 S	5/2014	Azzola et al.
8,928,186 B2	1/2015	Manzoli et al.
D733,070 S	6/2015	Engblom et al.
D752,524 S	3/2016	Azzola et al.
D755,131 S	5/2016	Azzola et al.
D778,843 S *	2/2017	Gronqvist D13/162
D781,790 S *	3/2017	Leveque D13/160
D781,791 S *	3/2017	Leveque D13/160
D789,895 S *	6/2017	Azzola D13/160
D803,166 S *	11/2017	Azzola D13/160
D807,304 S *	1/2018	Azzola D13/162
2001/0022713 A1	9/2001	Gimenez et al.
2001/0025773 A1	10/2001	Rane et al.
2004/0045796 A1	3/2004	Azzola et al.
2005/0109597 A1	5/2005	Etscheidt et al.
2005/0167256 A1	8/2005	Ford et al.
2006/0118397 A1	6/2006	Dahl et al.
2009/0014292 A1	1/2009	Lyu
2012/0325628 A1	12/2012	Besana et al.
2013/0001953 A1	1/2013	Brignoli et al.
2014/0029153 A1	1/2014	Besana et al.
2016/0217950 A1	7/2016	Bresciani et al.

OTHER PUBLICATIONS

Terasaki Electric. Revolution in circuit breaker technology, pp. 35. date unknown.
 ABB SACE L.V. Low voltage power circuit-breakers SACE eMAX. Technical catalog. 604020/011, May 1999, pp. 119.
 Co-pending U.S. Appl. No. 29/394,398, filed Jun. 16, 2011.
 Co-pending U.S. Appl. No. 29/416,701, filed Mar. 26, 2012.
 Co-pending U.S. Appl. No. 29/459,435, filed Jun. 26, 2013.

* cited by examiner

Figure 1

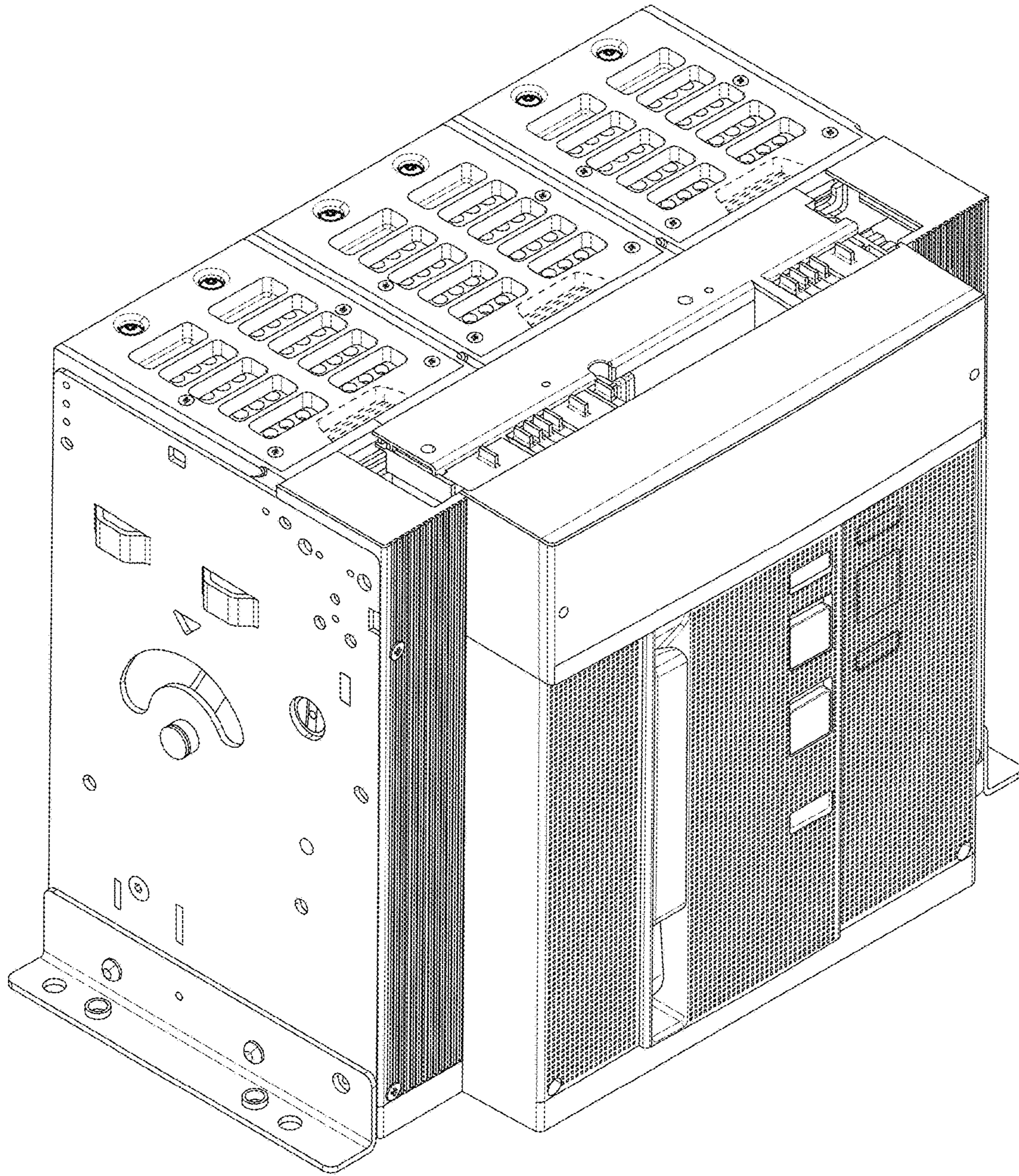

Figure 2

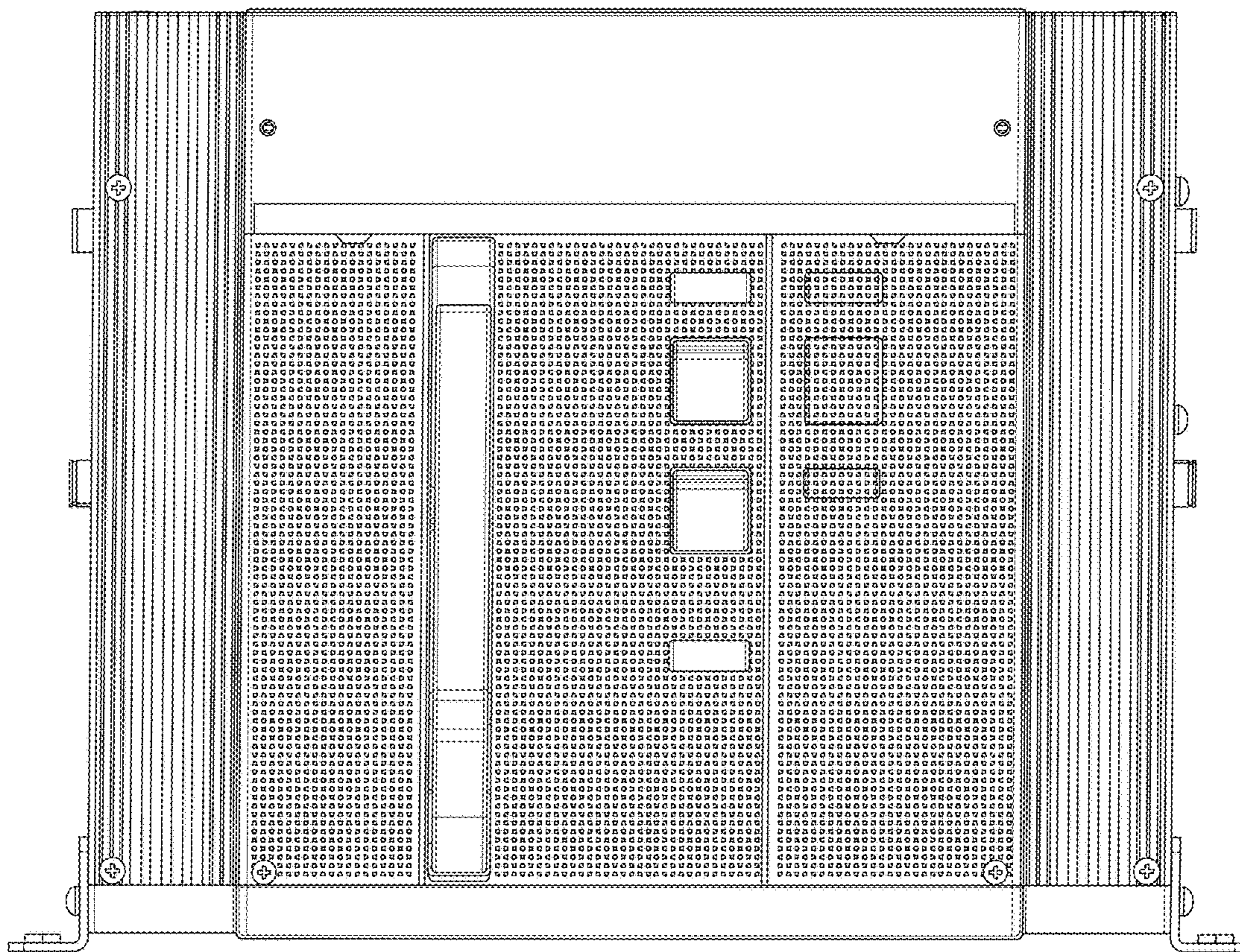

Figure 3

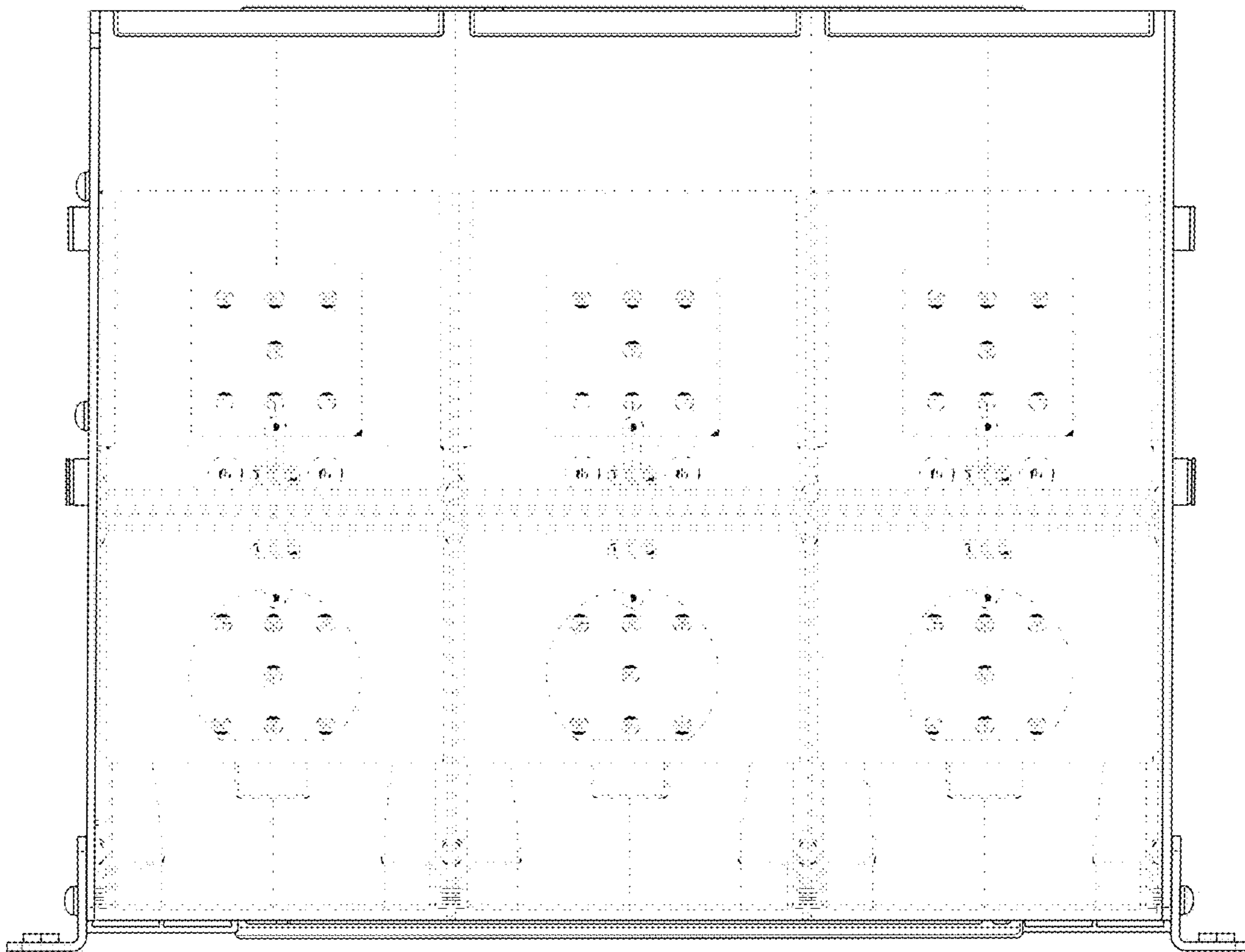

Figure 4

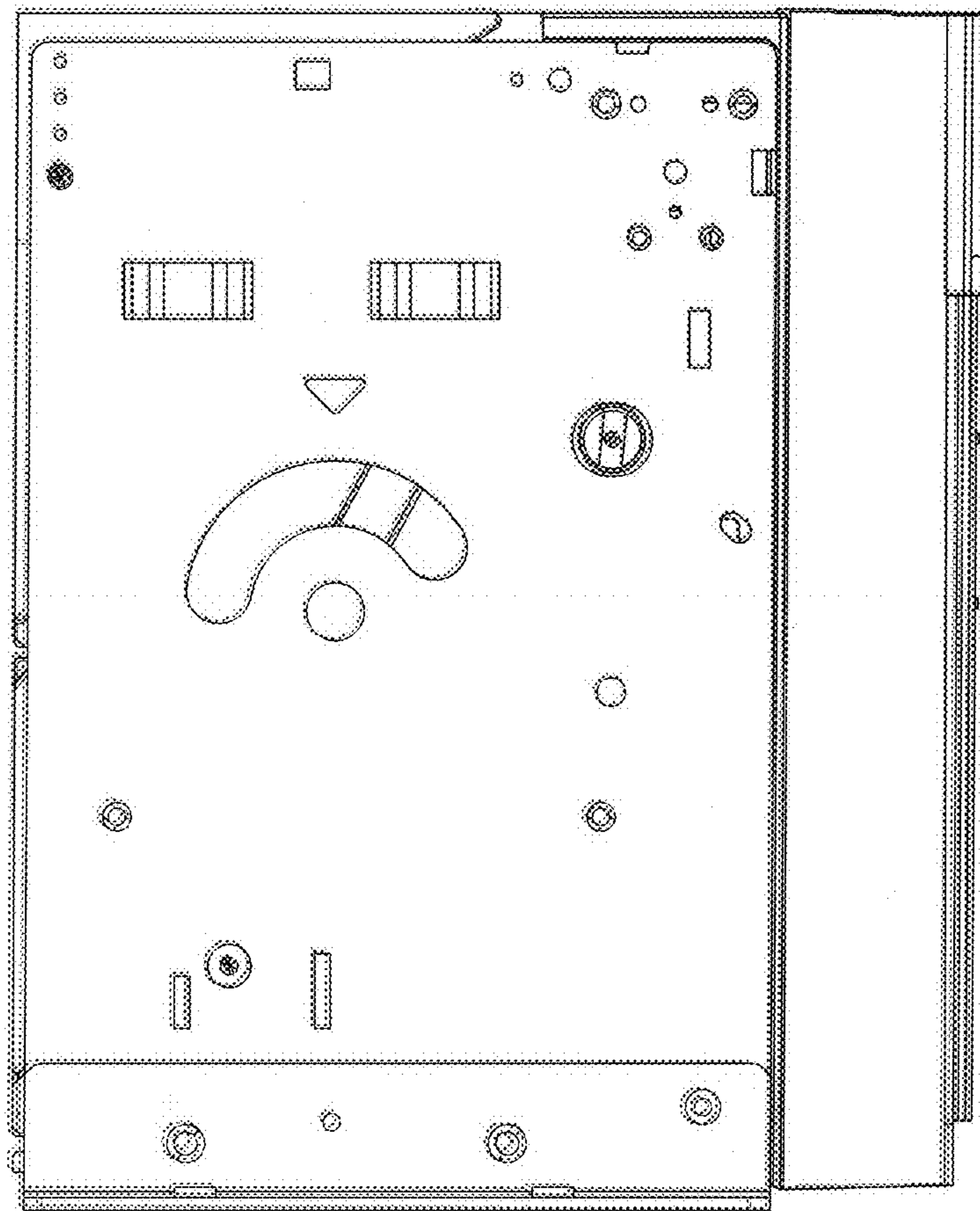

Figure 5

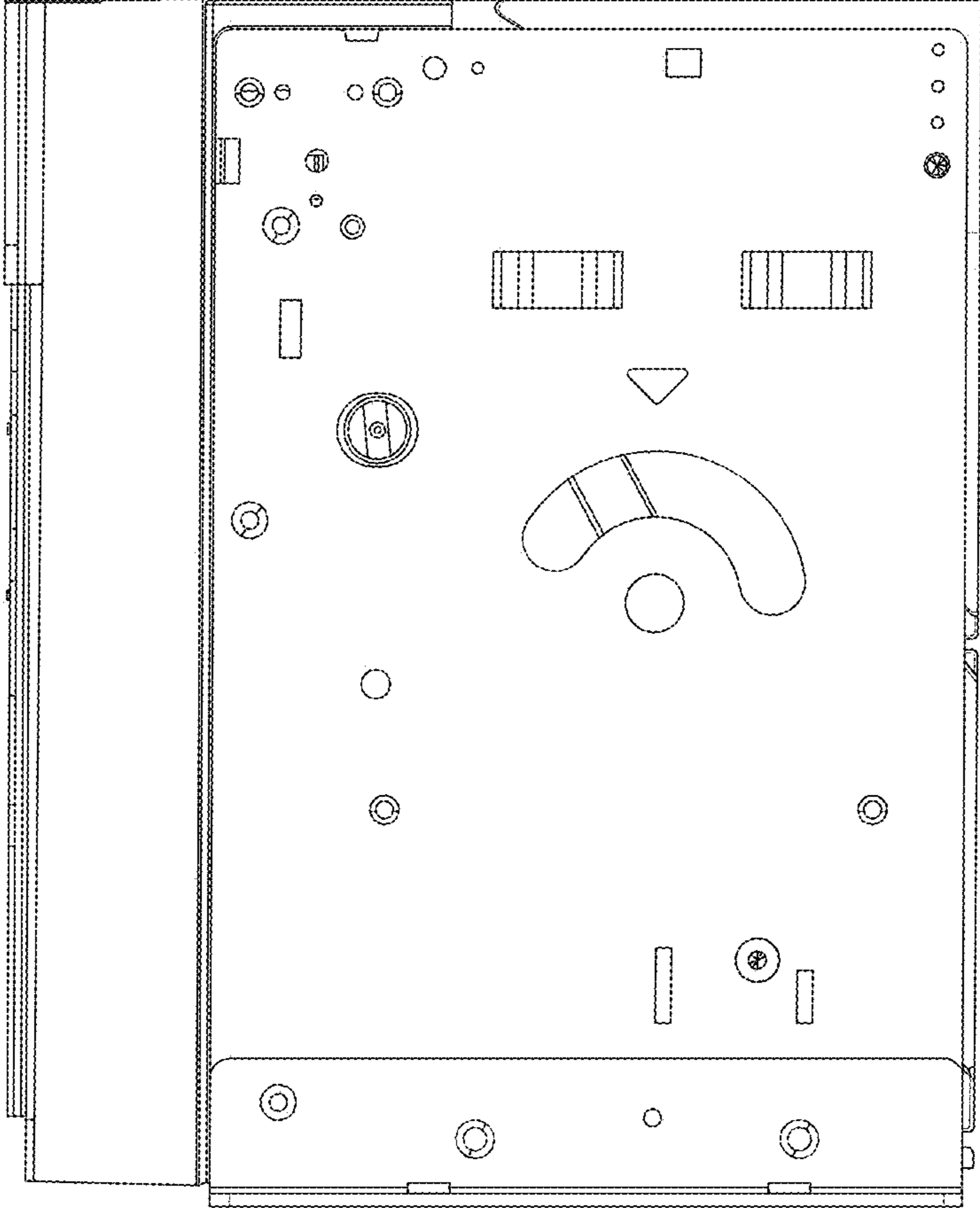

Figure 6

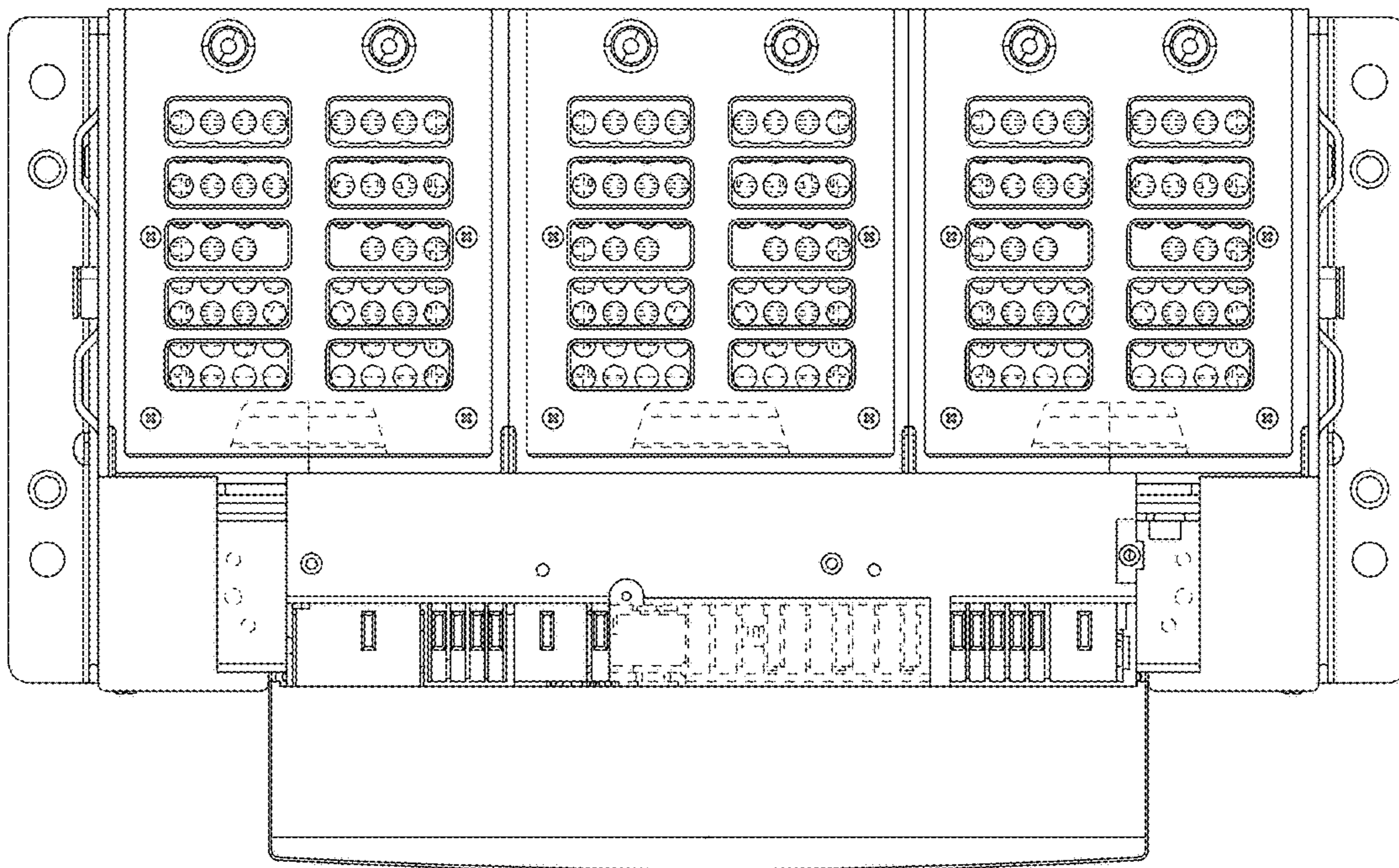

Figure 7

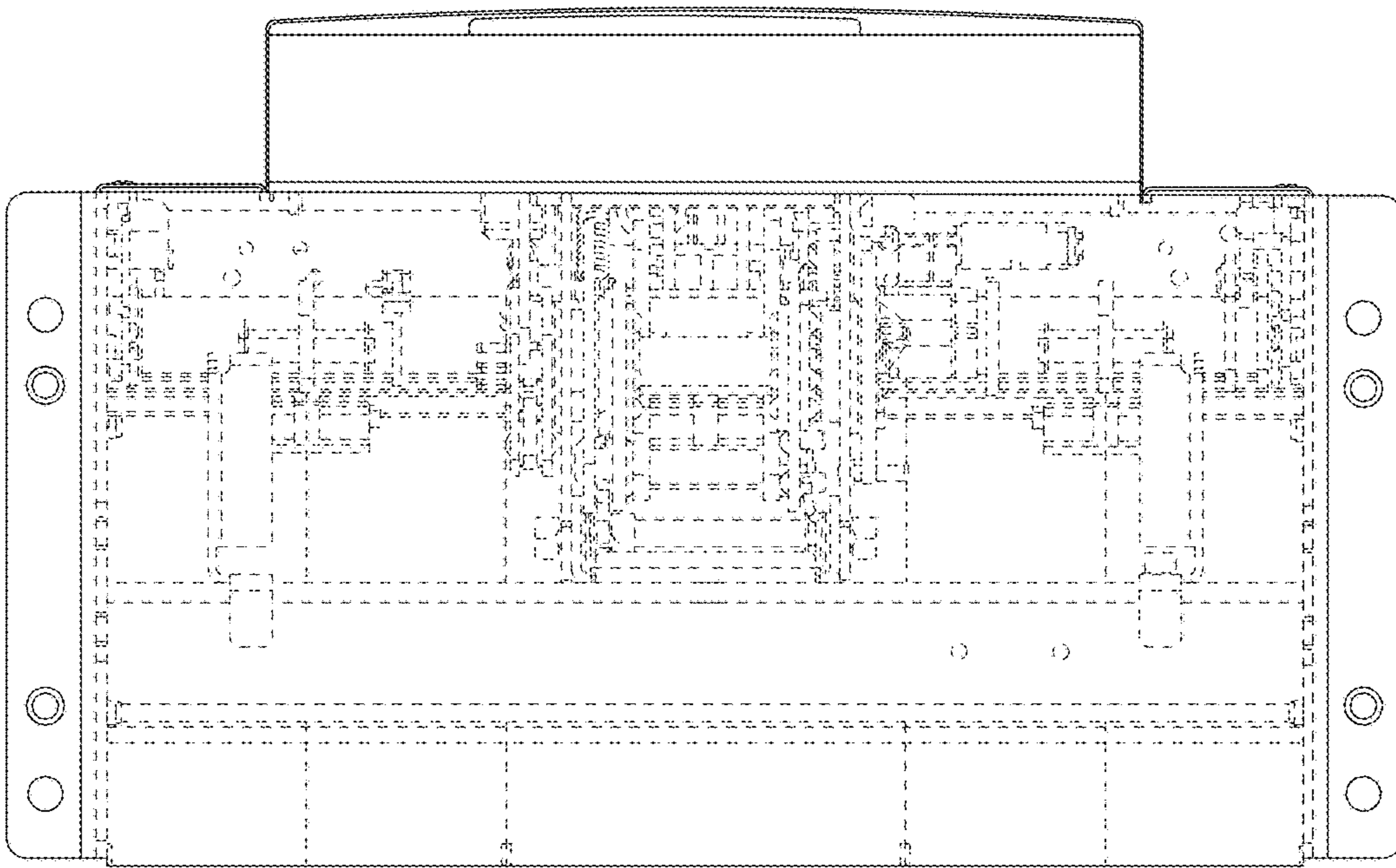

Figure 8

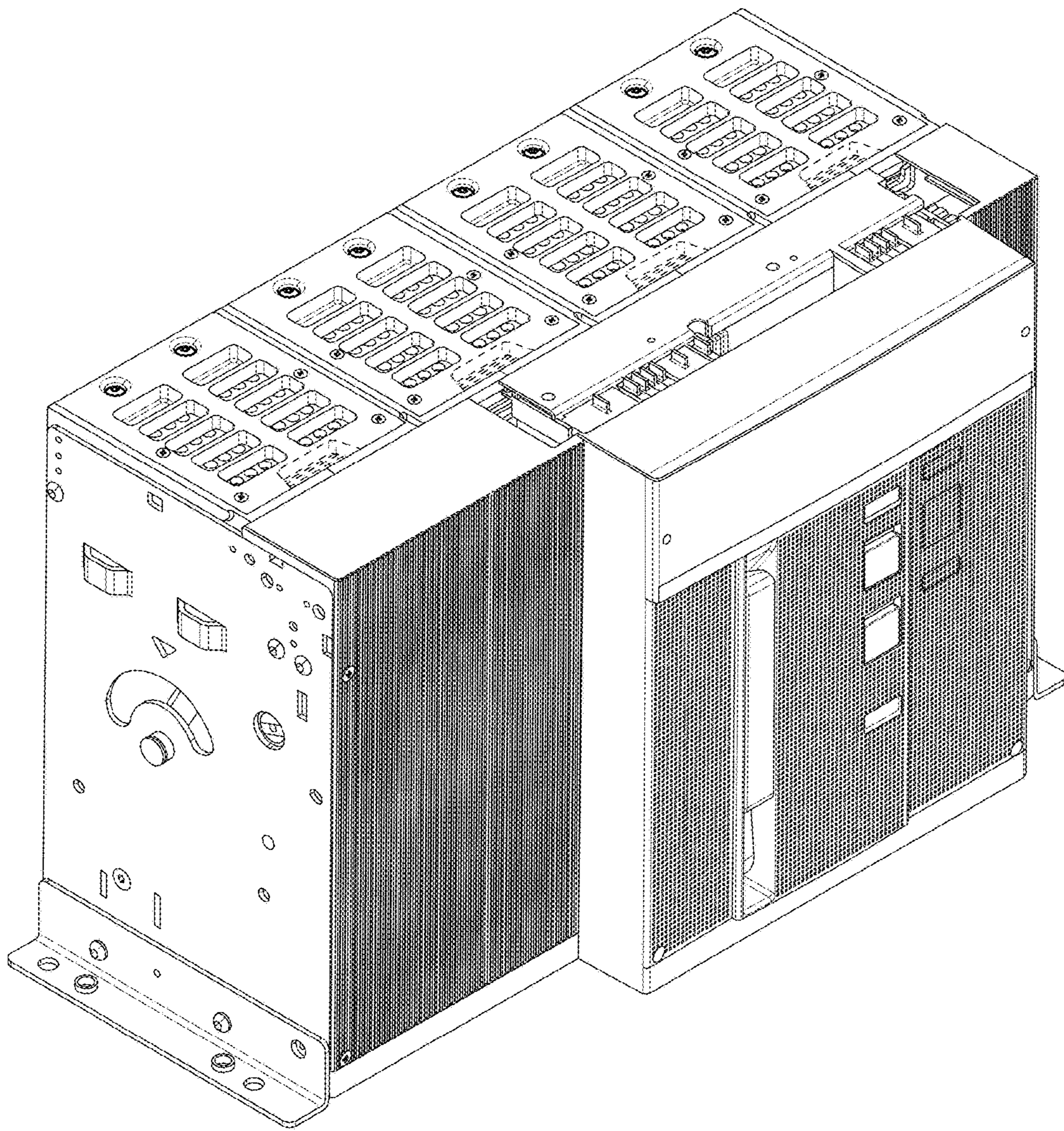

Figure 9

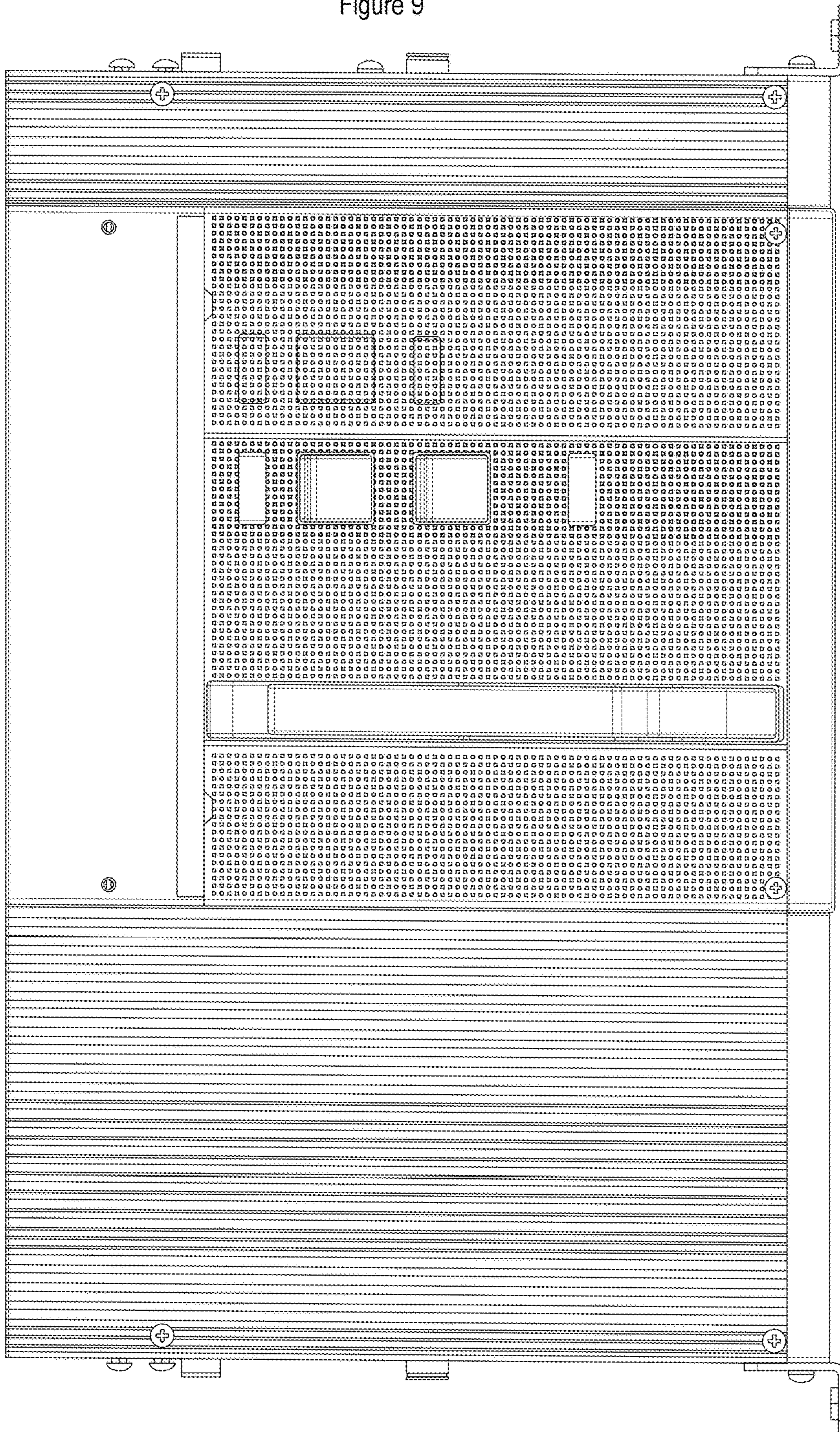

Figure 10

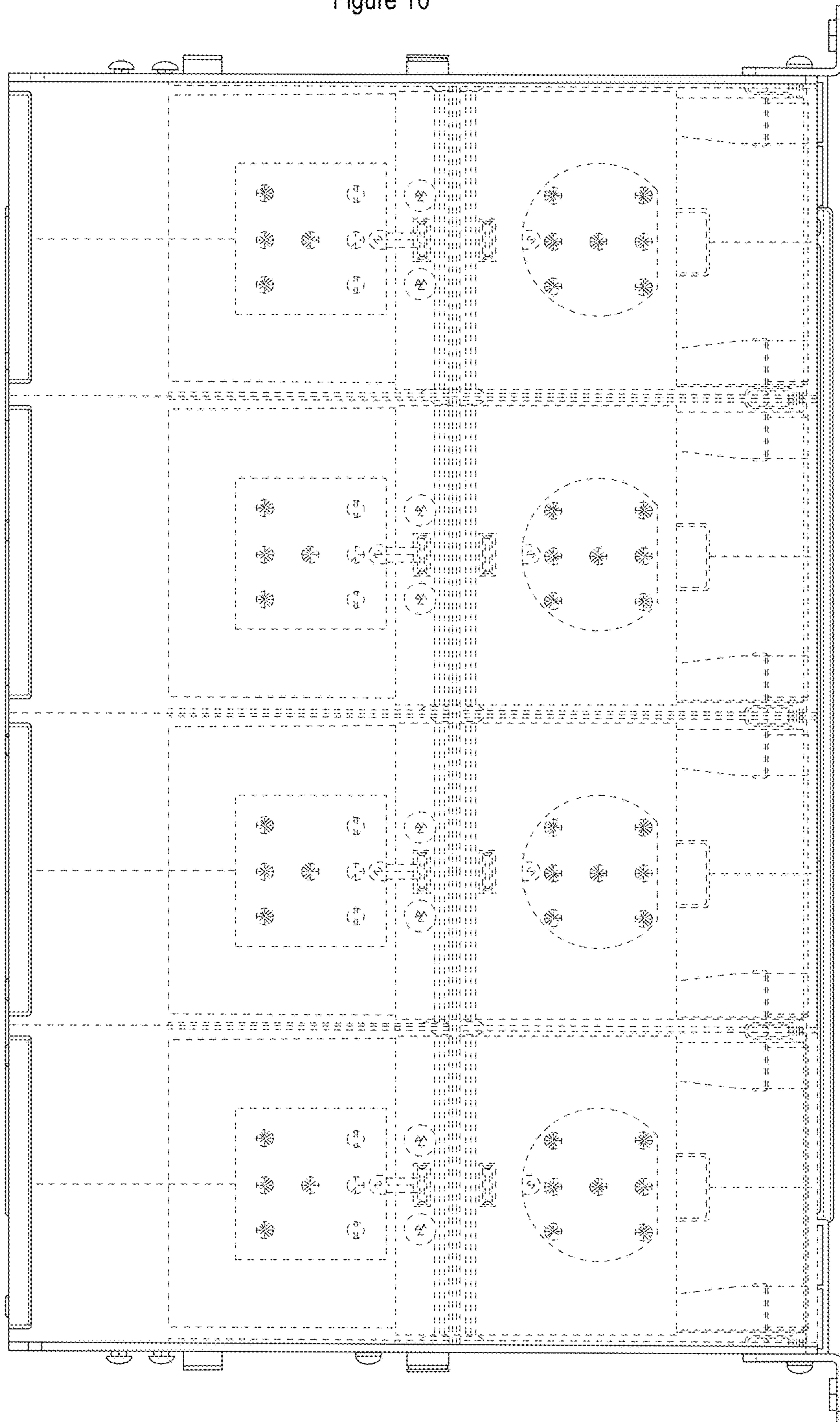

Figure 11

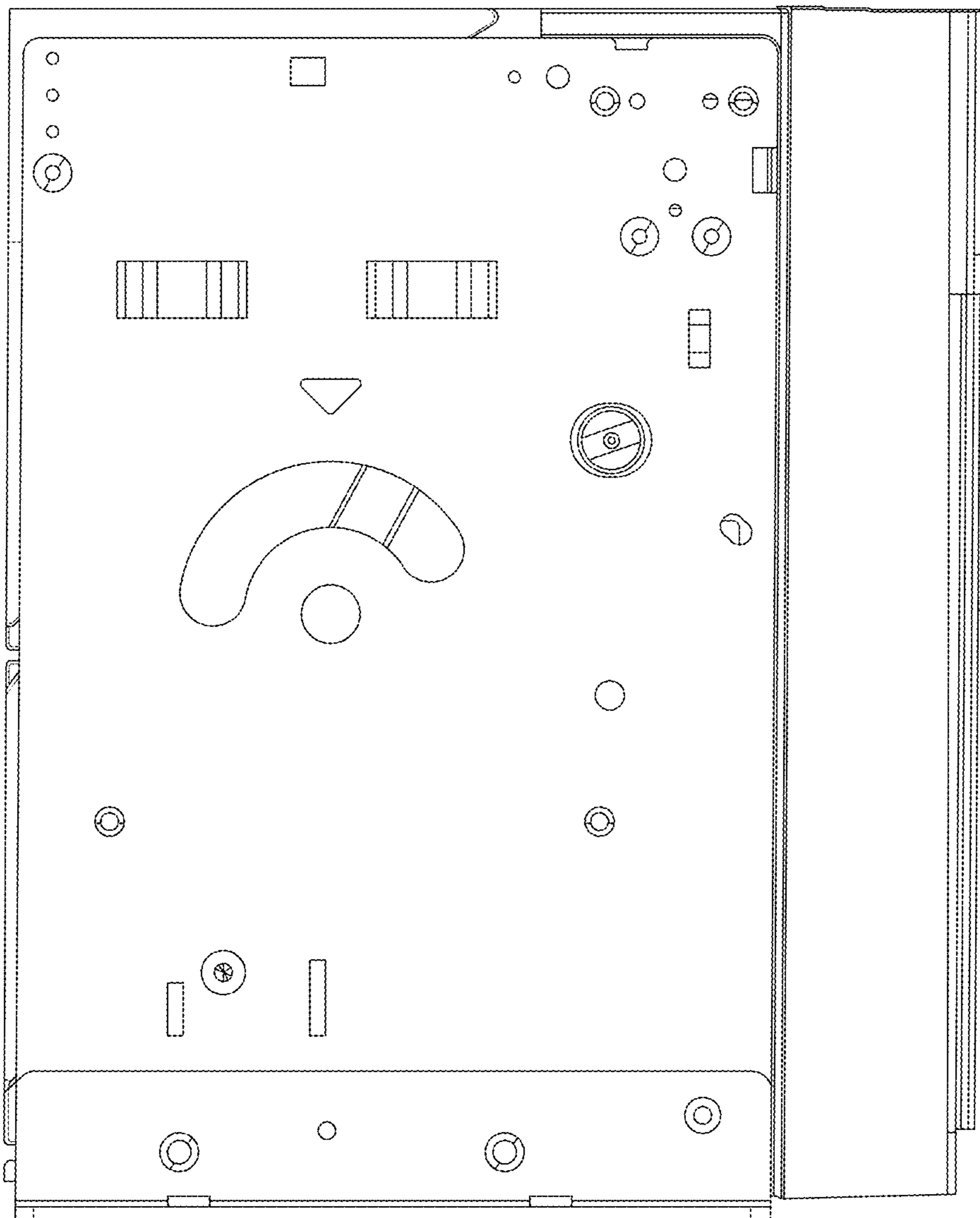

Figure 12

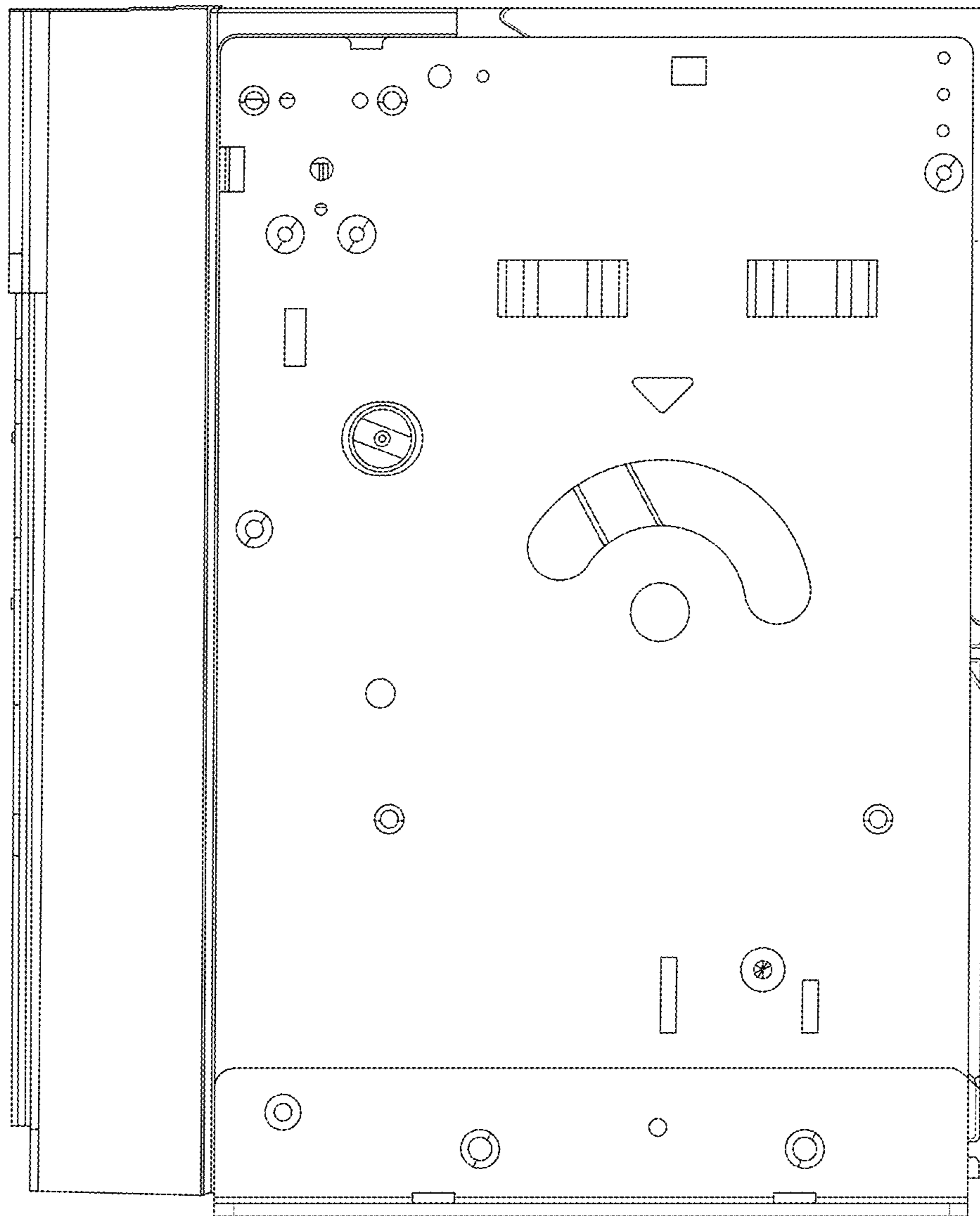

Figure 13

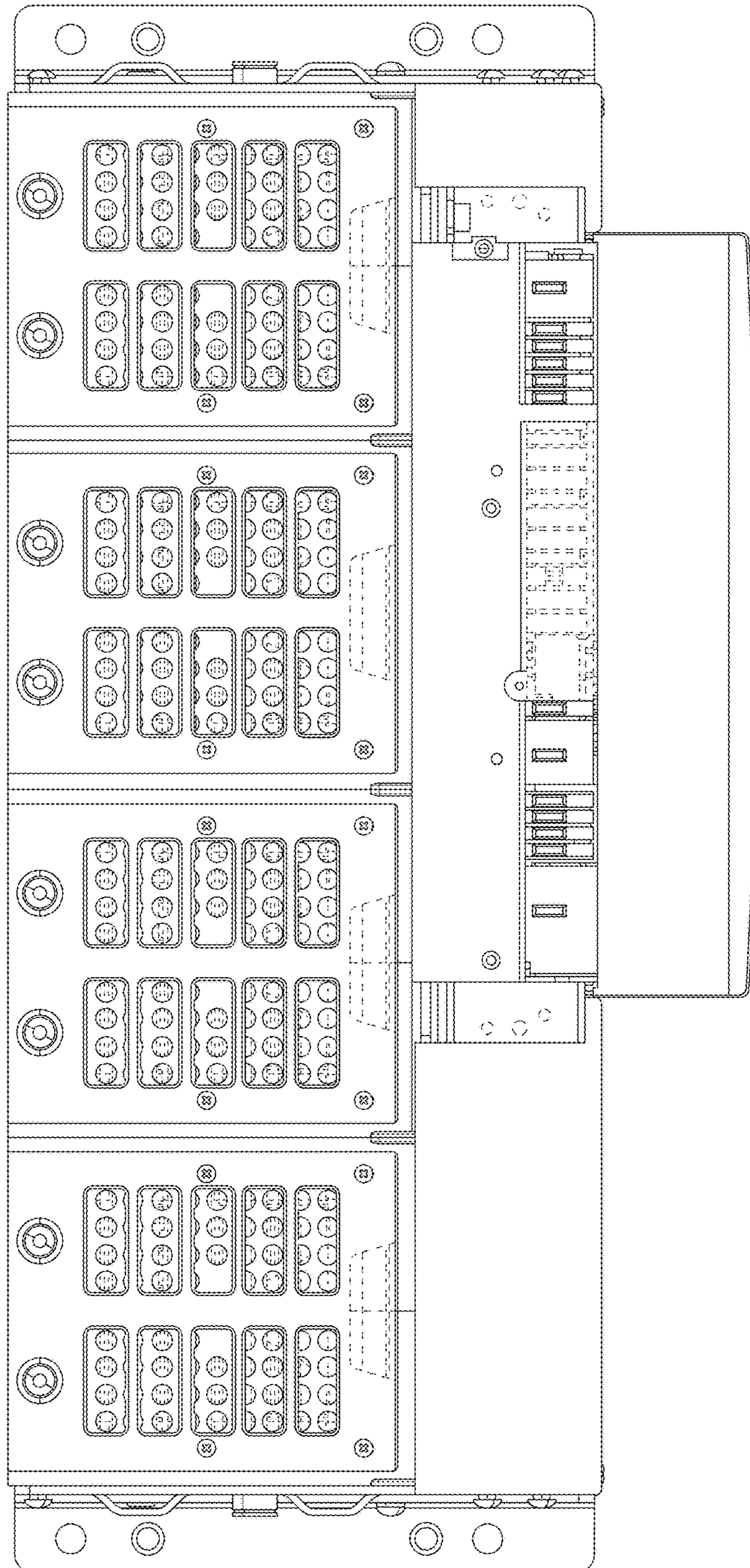

Figure 14

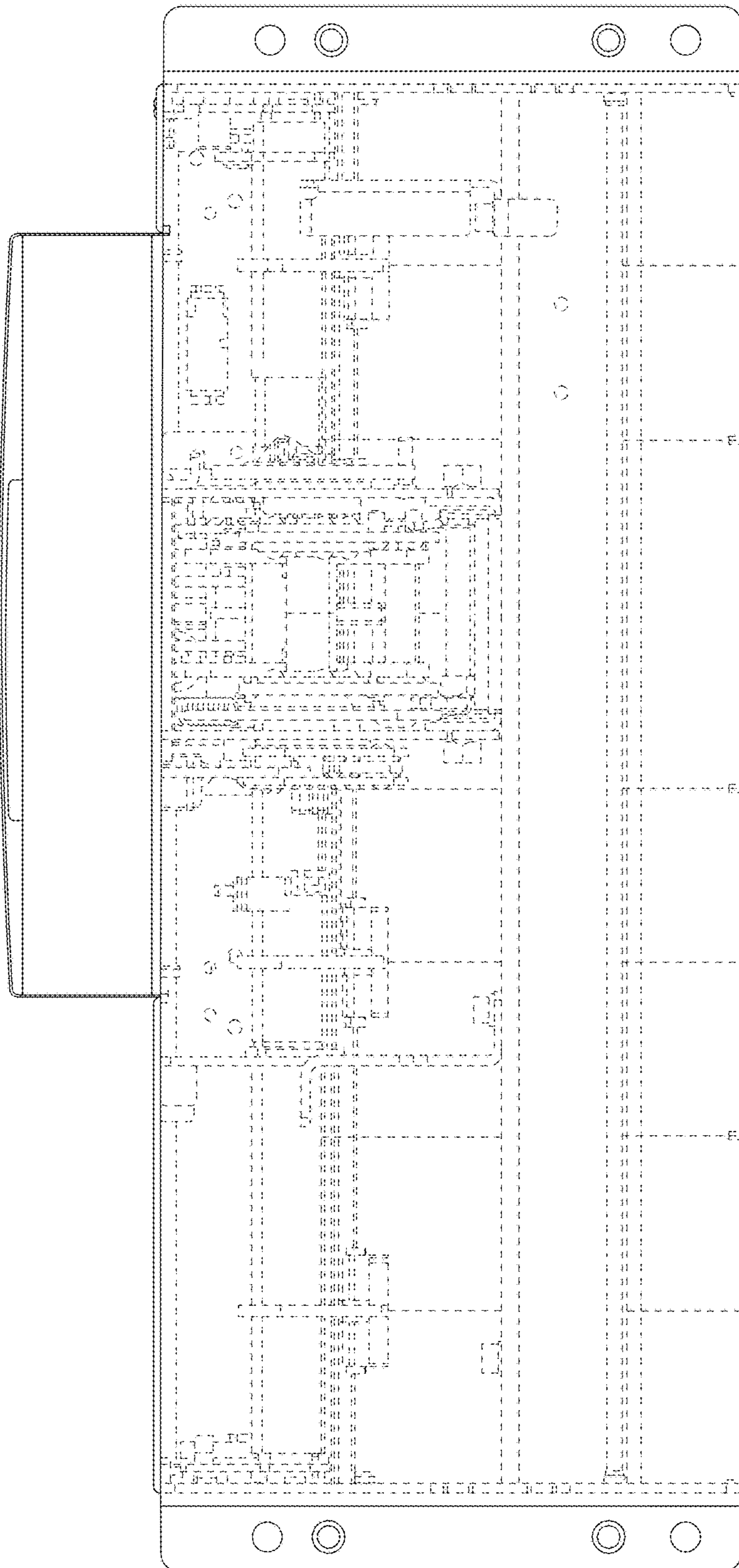

Figure 15

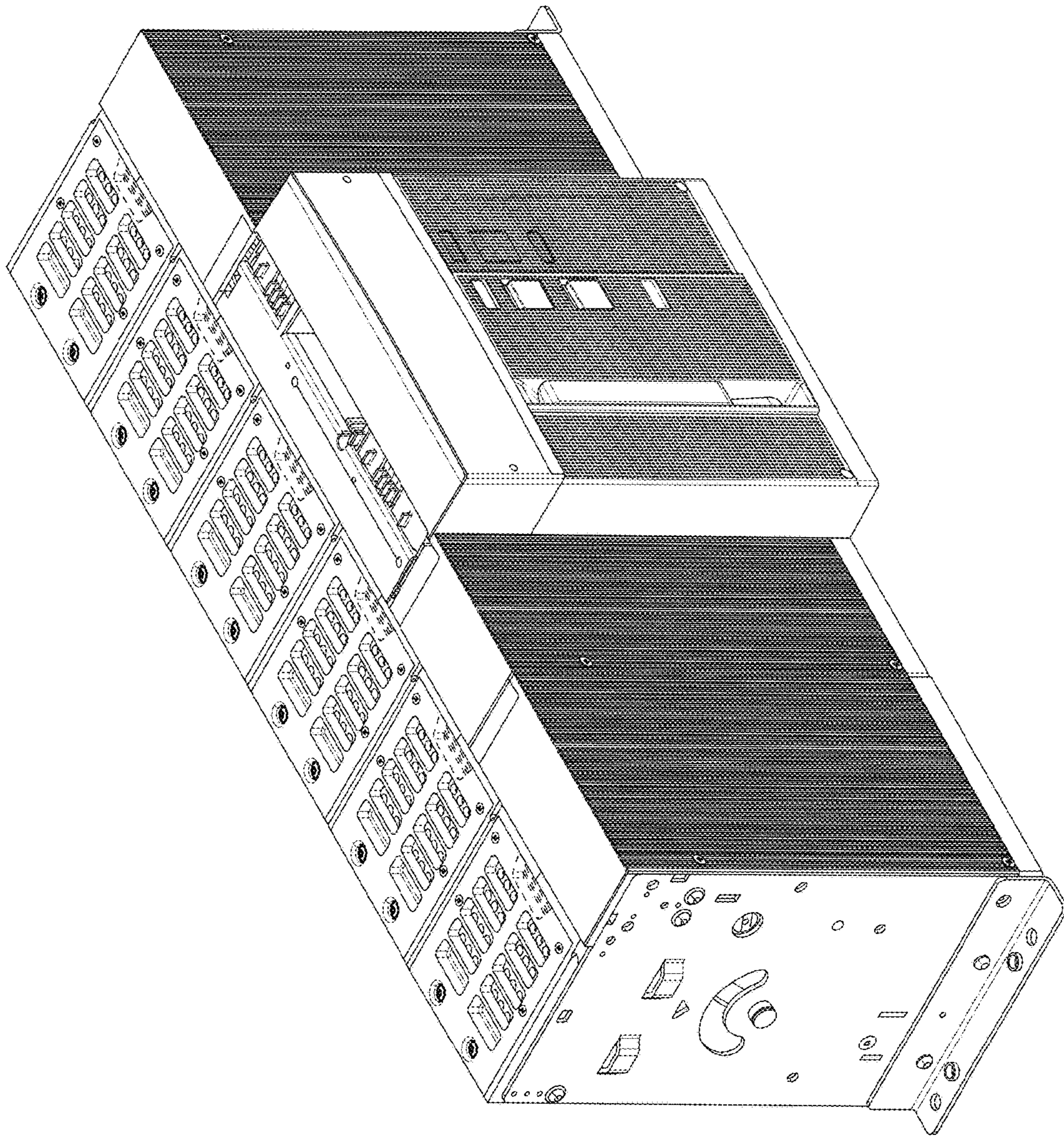

Figure 16

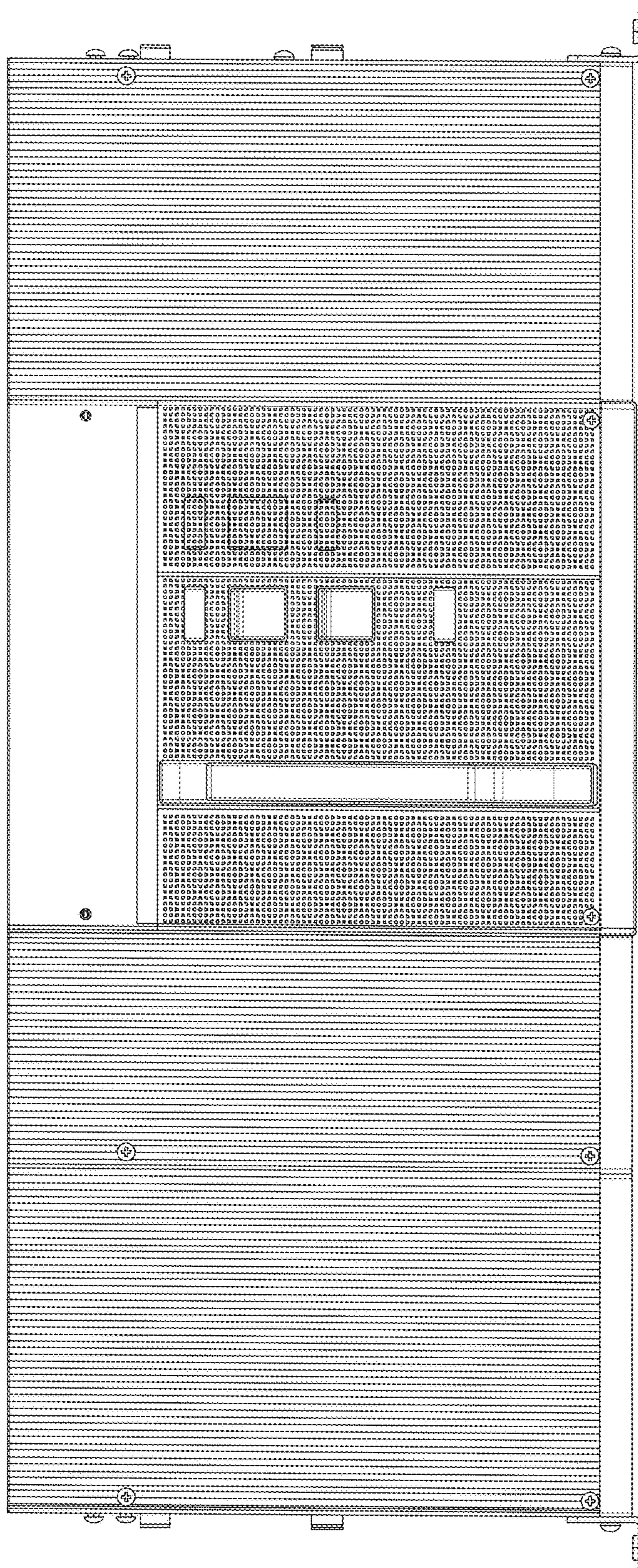

Figure 17

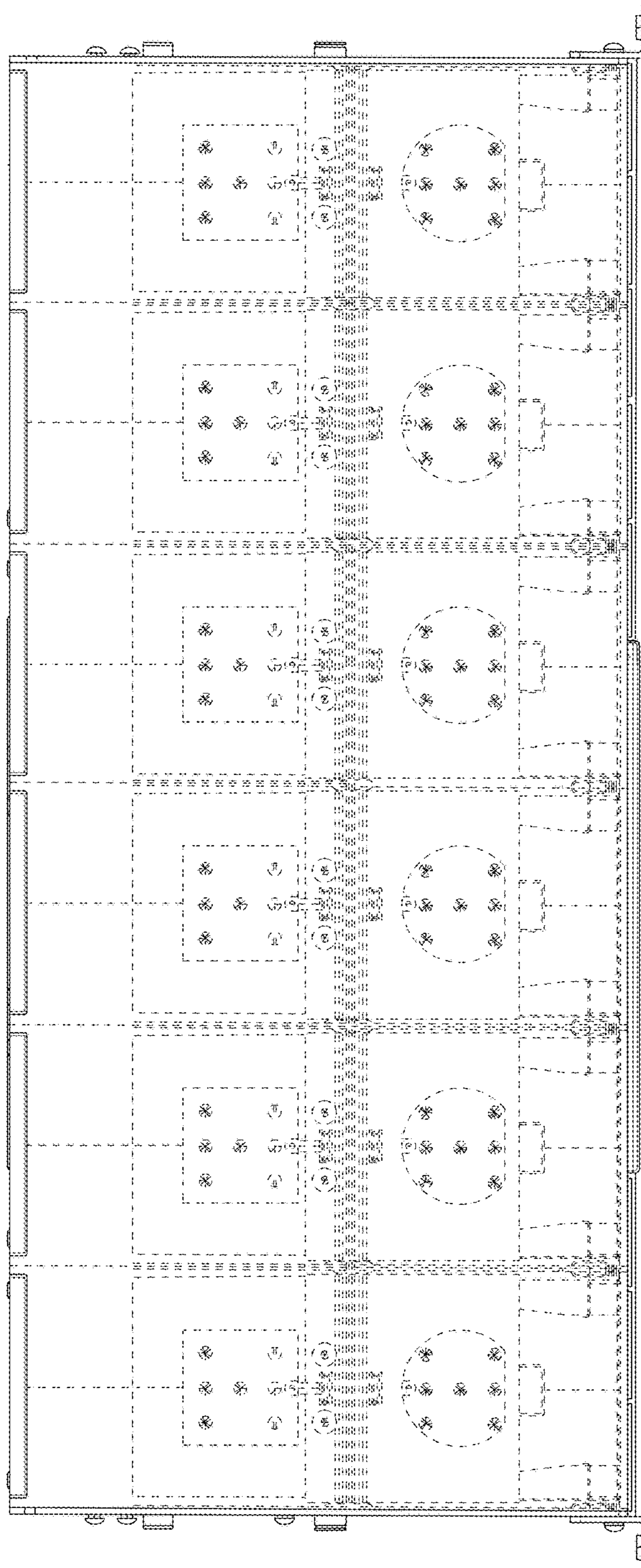

Figure 18

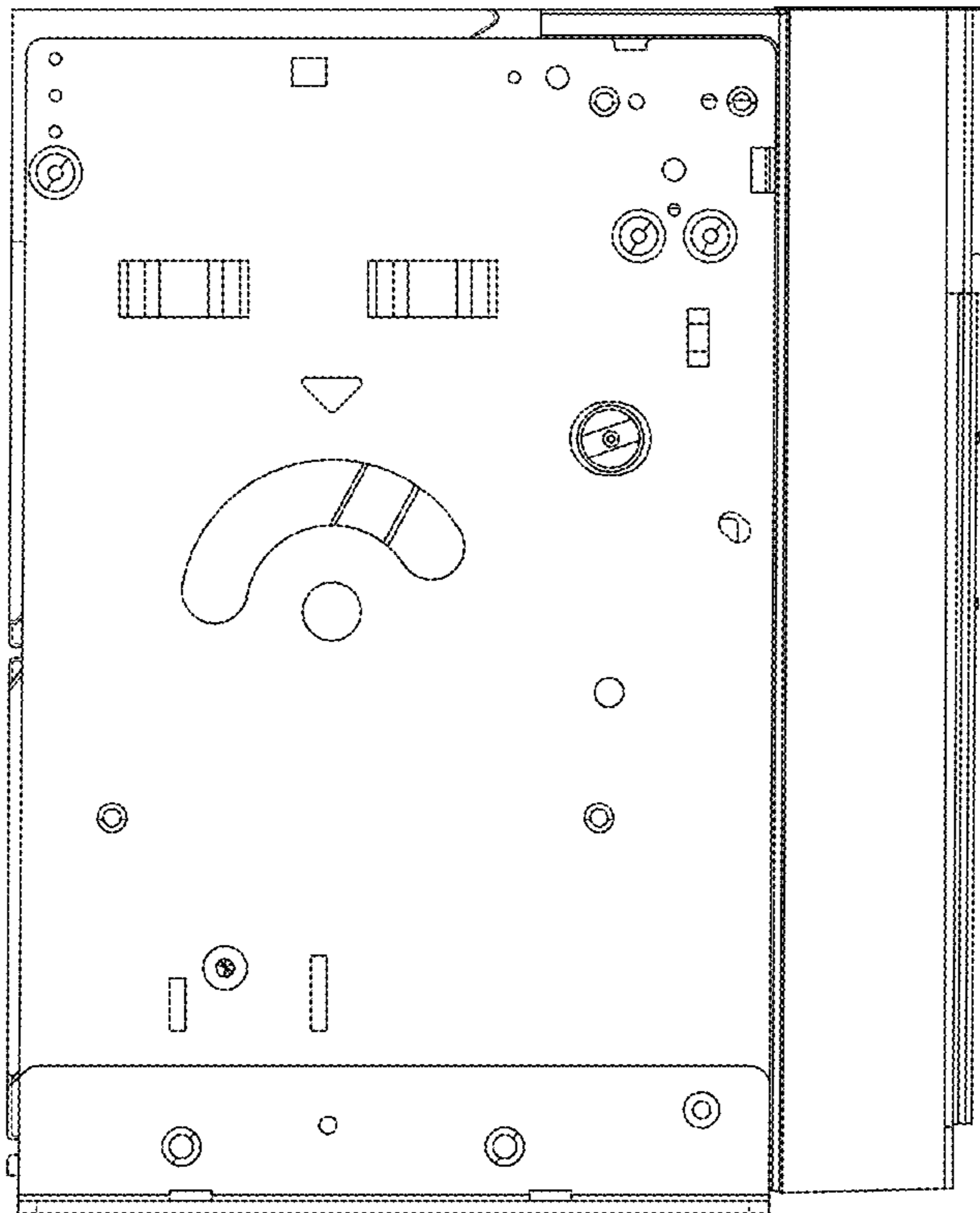

Figure 19

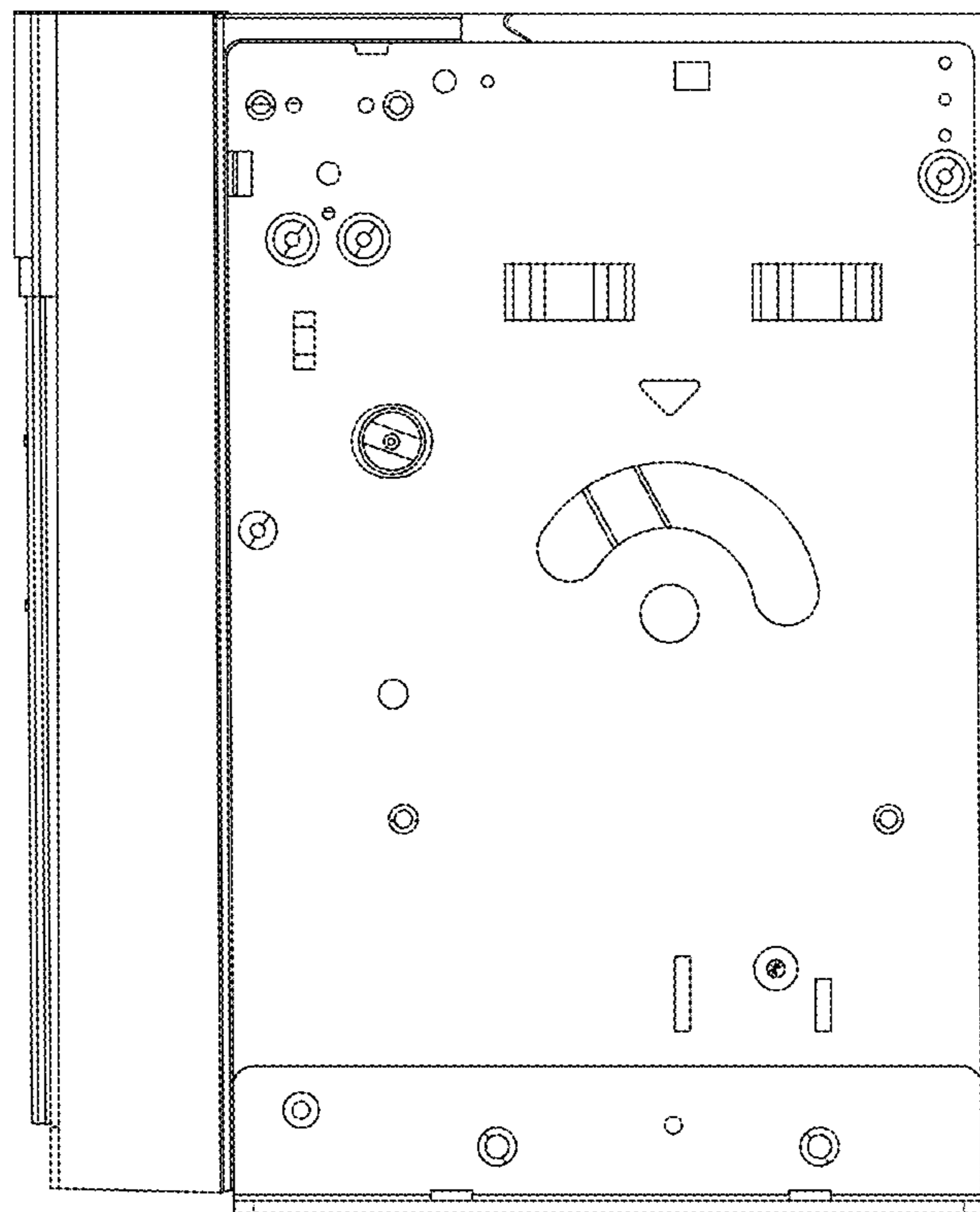

Figure 20

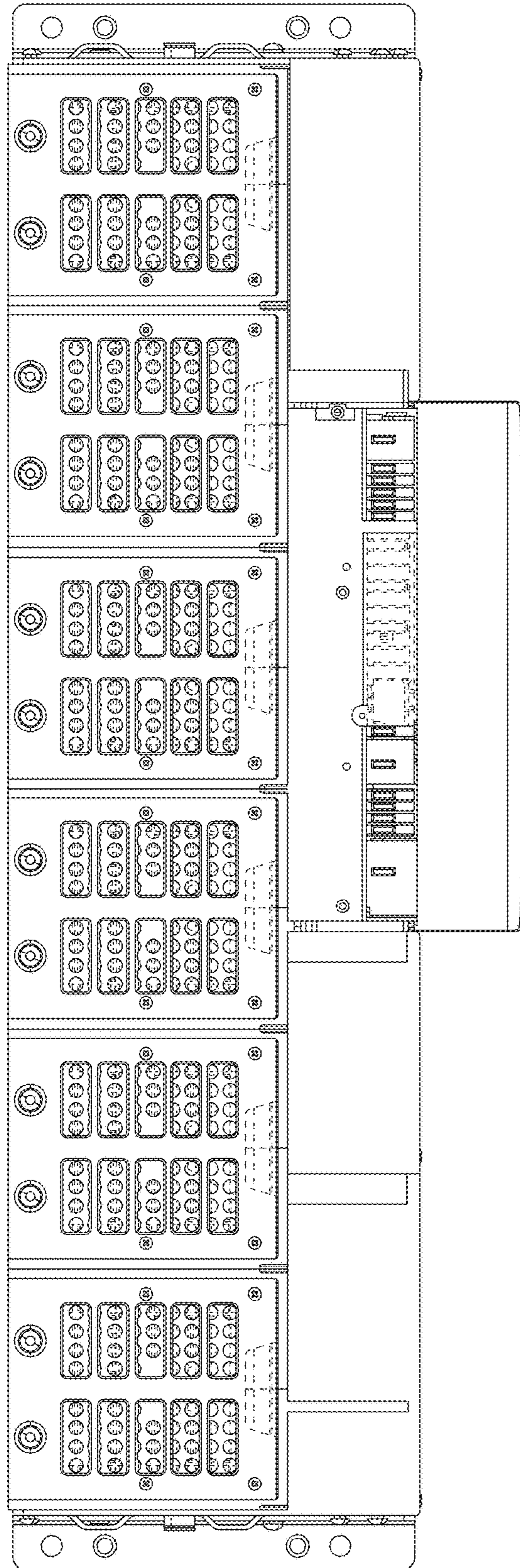

Figure 21

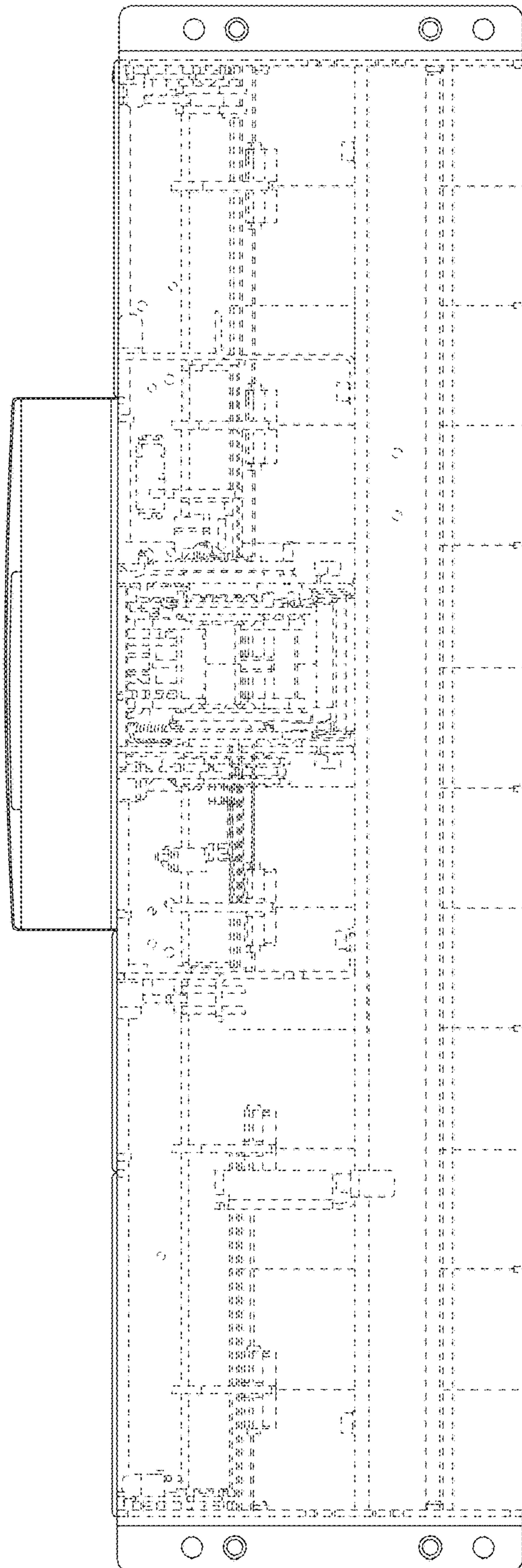

Figure 22

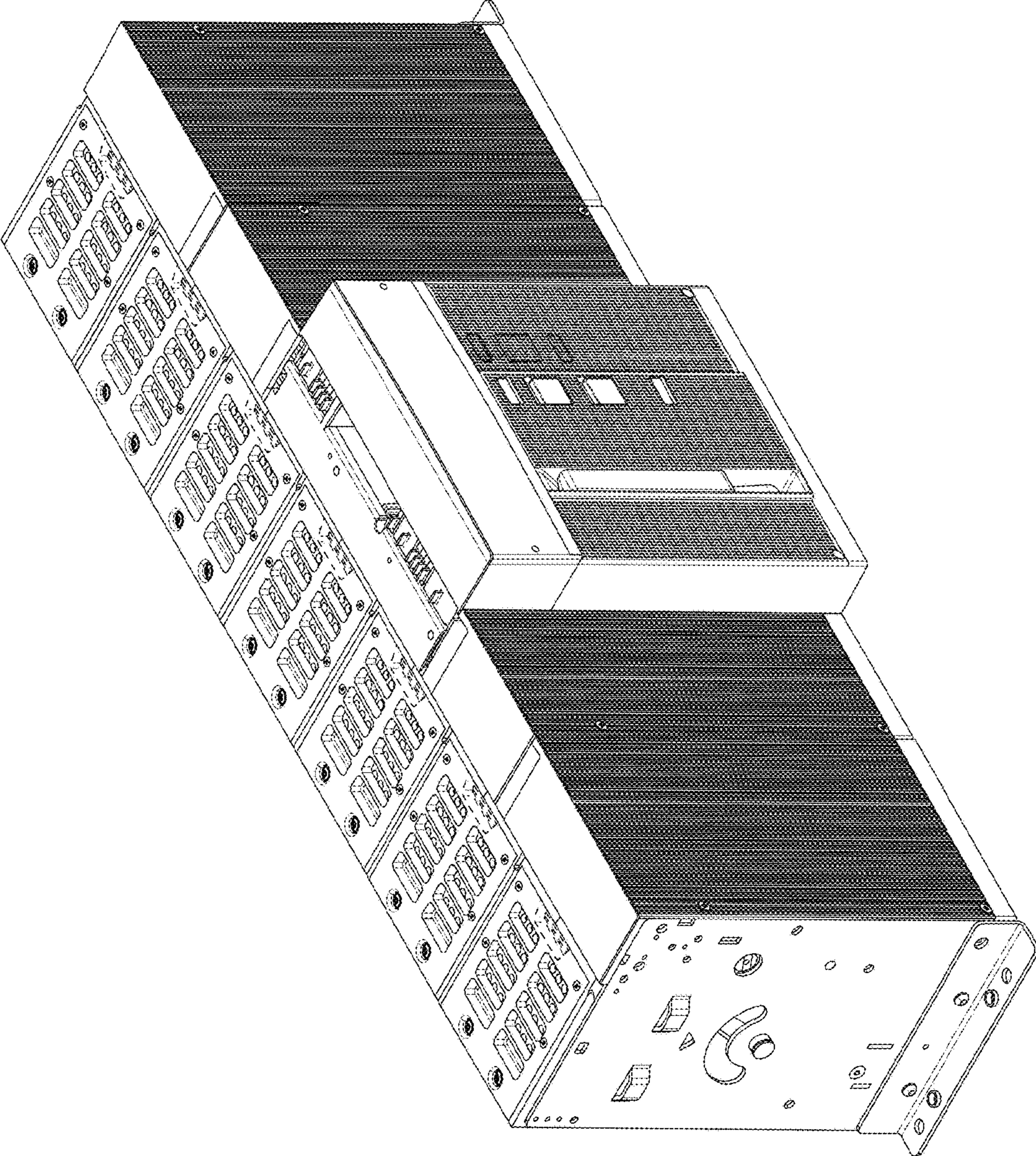

Figure 23

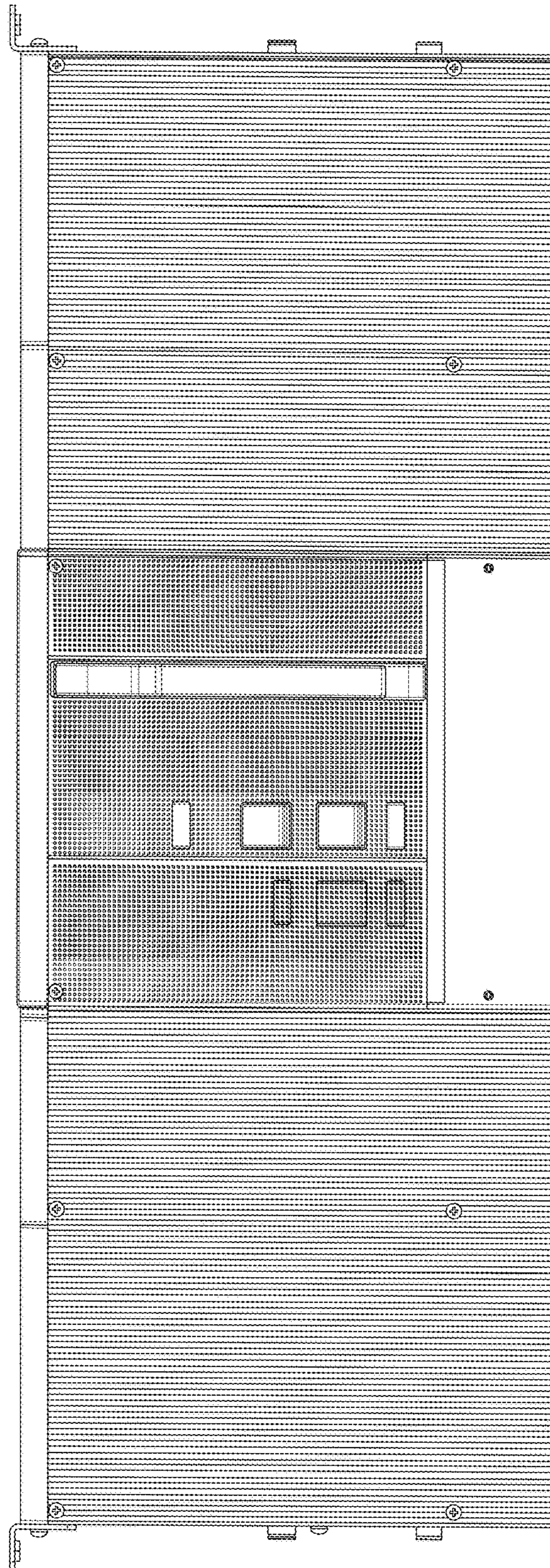

Figure 24

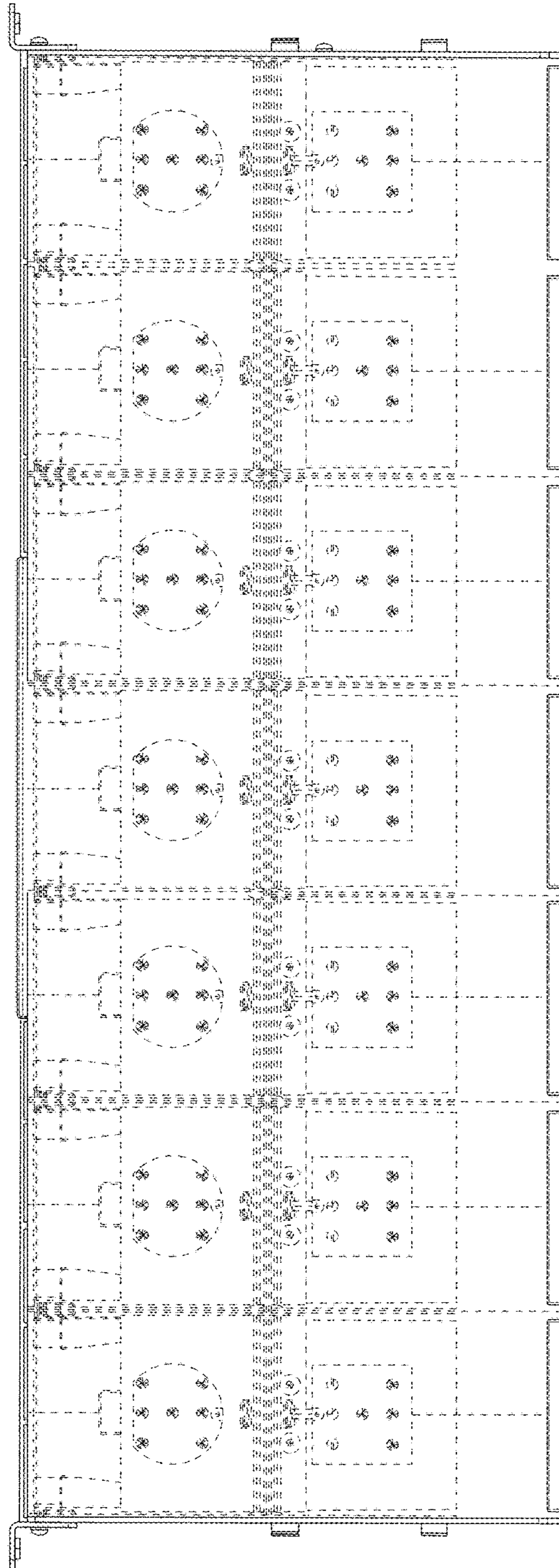

Figure 25

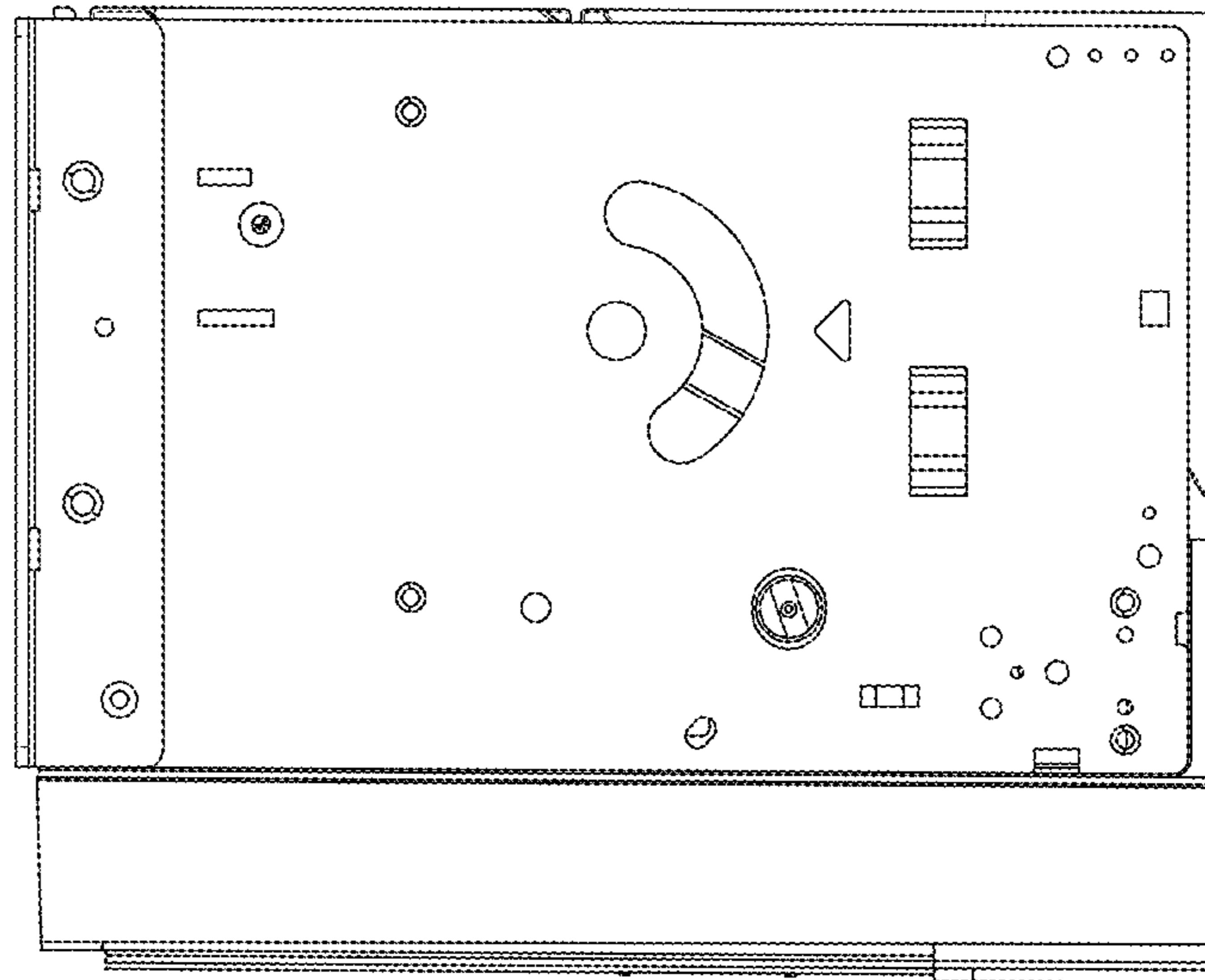

Figure 26

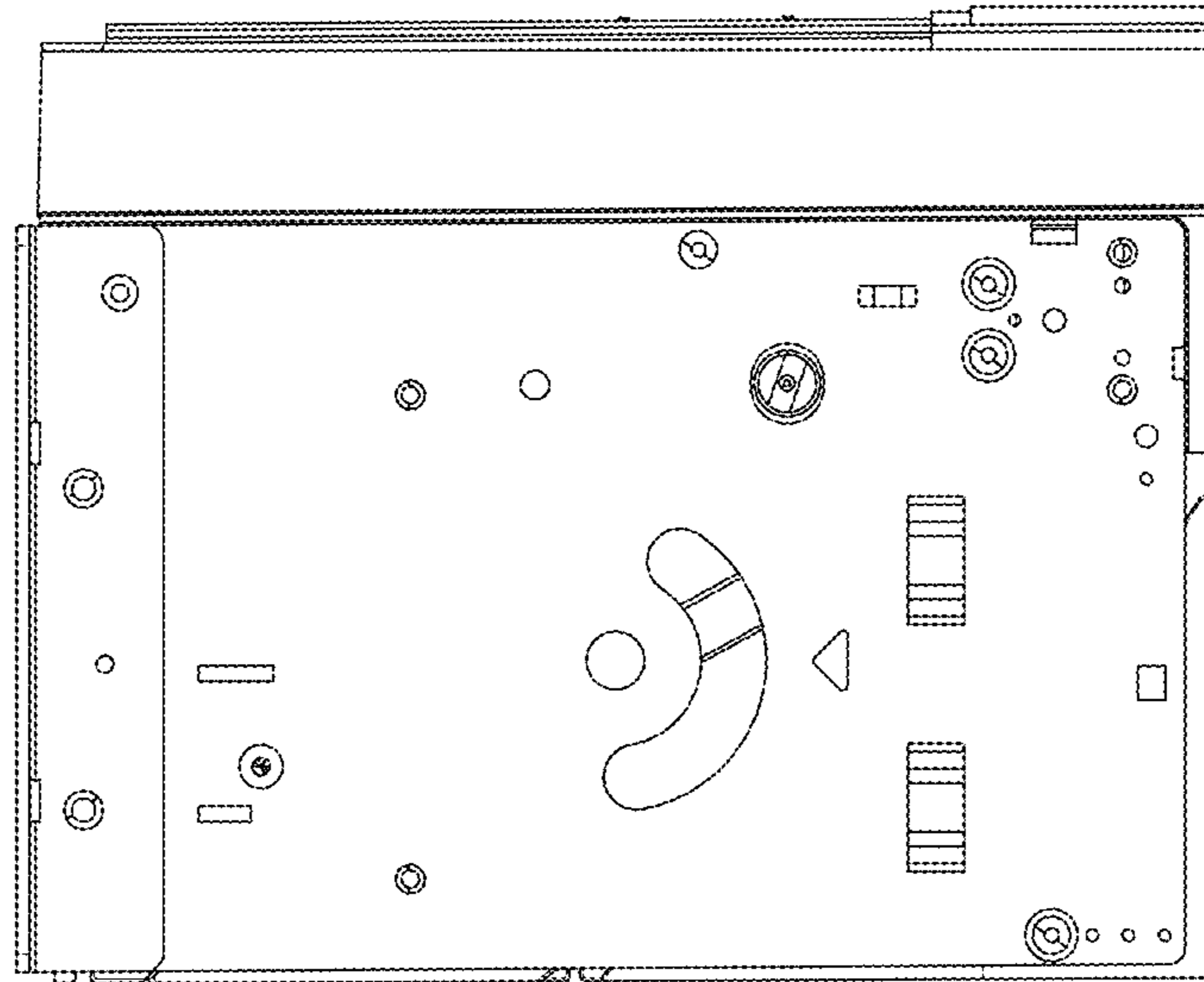

Figure 27

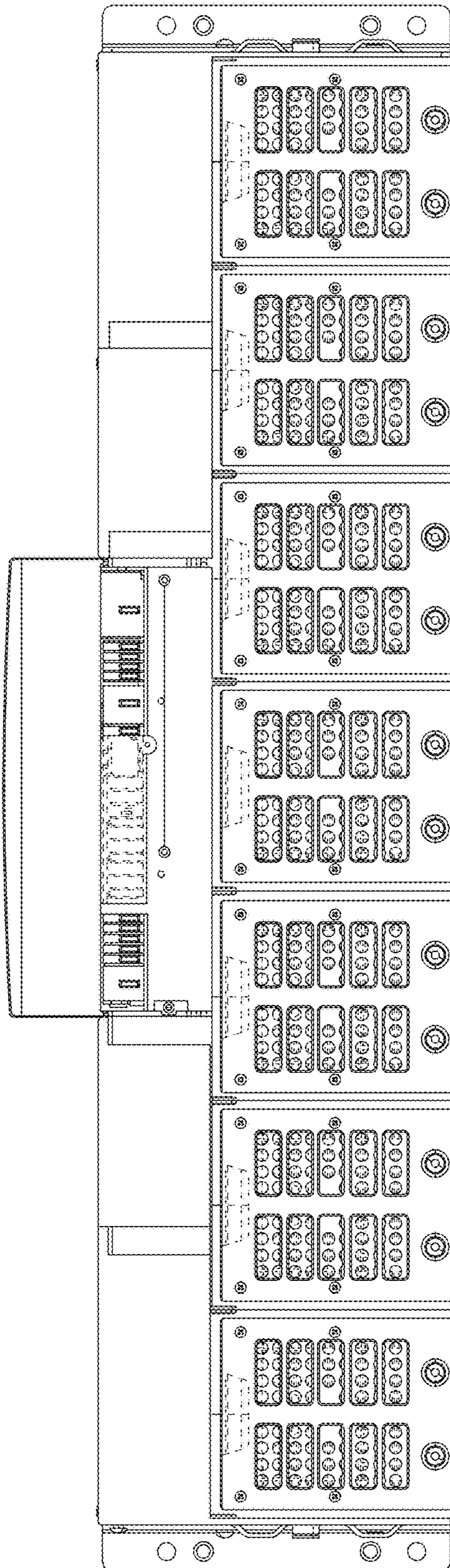

Figure 28

