



US00D823695S

(12) **United States Design Patent** (10) **Patent No.:** **US D823,695 S**
Totani (45) **Date of Patent:** **** Jul. 24, 2018**

(54) **SPOUTED POUCH**

(71) Applicant: **TOTANI CORPORATION**, Kyoto-shi, Kyoto (JP)

(72) Inventor: **Mikio Totani**, Tokyo (JP)

(73) Assignee: **TOTANI CORPORATION**, Kyoto-Shi (JP)

(**) Term: **15 Years**

(21) Appl. No.: **29/624,279**

(22) Filed: **Oct. 31, 2017**

Related U.S. Application Data

(62) Division of application No. 29/574,608, filed on Aug. 17, 2016, now Pat. No. Des. 808,820.

(30) **Foreign Application Priority Data**

Feb. 17, 2016 (JP) 2016-003325
Feb. 17, 2016 (JP) 2016-003326
Feb. 17, 2016 (JP) 2016-003327
Feb. 17, 2016 (JP) 2016-003331
Feb. 17, 2016 (JP) 2016-003333
Feb. 17, 2016 (JP) 2016-003334
Feb. 17, 2016 (JP) 2016-003335

(Continued)

(51) **LOC (11) Cl.** **09-05**

(52) **U.S. Cl.**
USPC **D9/707**

(58) **Field of Classification Search**
USPC D9/702-714, 719, 738-740, 517-518,
D9/522, 416, 435, 444, 460, 455, 414,

(Continued)

(56) **References Cited**

U.S. PATENT DOCUMENTS

D344,015 S * 2/1994 Jacobson D3/227
D344,016 S * 2/1994 Jacobson D9/709

(Continued)

FOREIGN PATENT DOCUMENTS

EM 001239750-0010 10/2010
JP D1064028 A 3/2000

(Continued)

OTHER PUBLICATIONS

Packaging Digest, vol. 4, No. 41, p. 36 (no data) (Cited in parent U.S. Appl. No. 29/574,608, filed Aug. 17, 2016).

(Continued)

Primary Examiner — Abraham Bahta

(74) *Attorney, Agent, or Firm* — Westerman, Hattori, Daniels & Adrian, LLP

(57) **CLAIM**

The ornamental design for a spouted pouch, as shown and described.

DESCRIPTION

FIG. 1 is an isometric view of a spouted pouch showing my new design, showing the top, front, and right side thereof. FIG. 2 is a front elevational view thereof.

FIG. 3 is a rear elevational view thereof.

FIG. 4 is a right side elevational view thereof.

FIG. 5 is a left side elevational view thereof.

FIG. 6 is a top plan view thereof.

FIG. 7 is a bottom plan view thereof; and,

FIG. 8 is an isometric view thereof, showing the spouted pouch in use in an expanded condition.

The broken line portions of the design are included to show unclaimed portions and form no part of the claim.

1 Claim, 4 Drawing Sheets

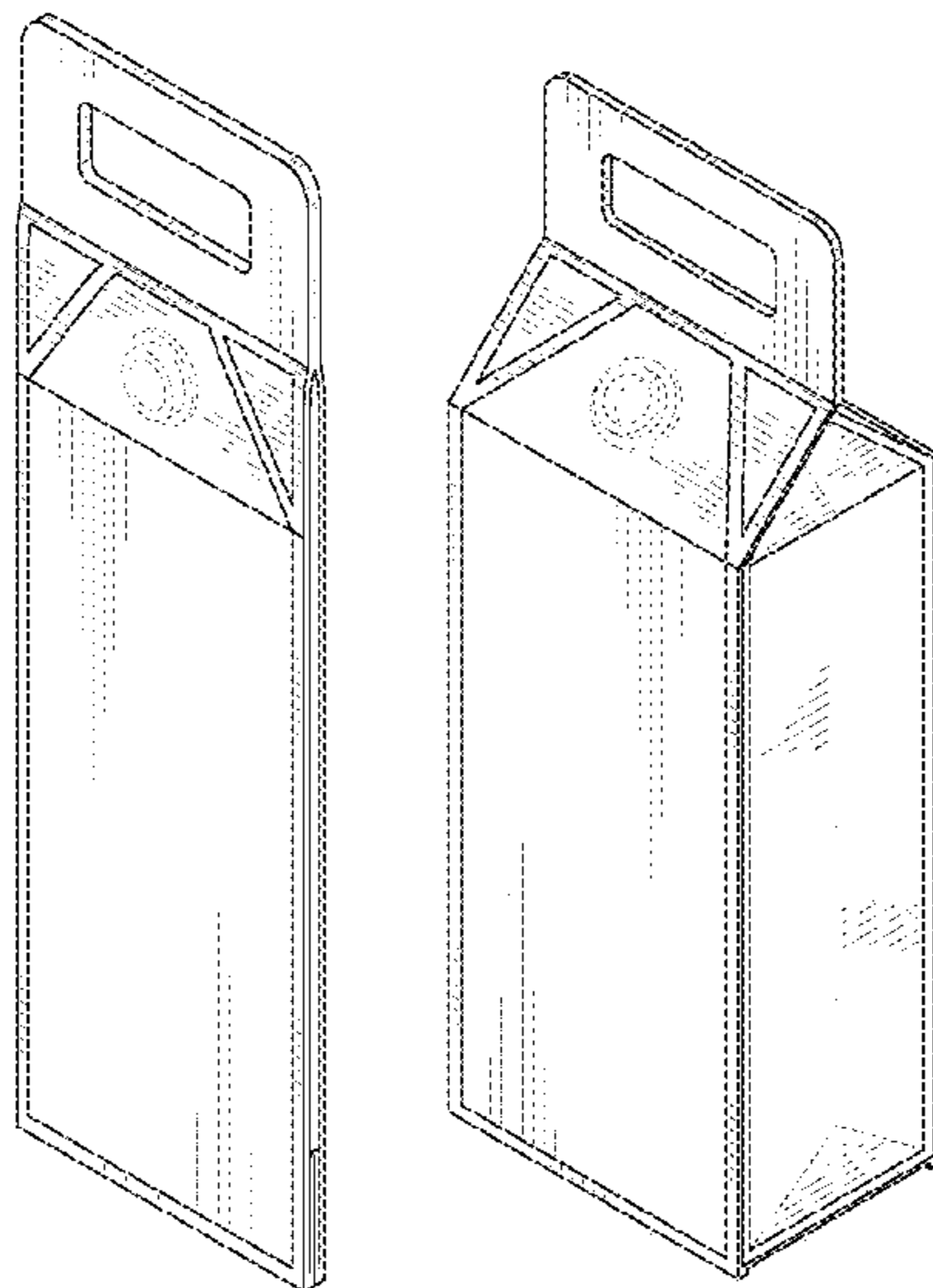

(30) Foreign Application Priority Data

Feb. 17, 2016 (JP) 2016-003336
 Feb. 17, 2016 (JP) 2016-003340

(58) Field of Classification Search

USPC D9/499, 431-432; D7/560-562;
 206/434, 426-427, 429-430, 485, 485.1,
 206/499, 508, 431, 418-422, 588-594,
 206/286, 299; 229/117.3, 185, 121, 122,
 229/200, 207, 236, 87.01, 923, 922,
 229/87.19, 87.18; 220/23.83;
 383/118-120, 110, 108, 127, 83, 6, 26,
 383/33, 78, 88; D3/303-307, 221, 226,
 D3/232, 276, 315; 150/100, 107, 112,
 150/118
 CPC A45C 3/00; A45C 3/04; A45C 3/06; A45C
 3/001; A45C 3/10; B65D 33/004; B65D
 33/00; B65D 33/06; B65D 33/12; B65D
 1/00; B65D 1/38; B65D 1/40; B65D
 29/00; B65D 29/04; B65D 31/00; B65D
 31/005; B65D 31/10; B65D 31/02; B65D
 31/04; B65D 31/18; B65D 65/00; B65D
 65/02; B65D 65/38; B65D 81/00; B65D
 81/36

See application file for complete search history.

(56) References Cited

U.S. PATENT DOCUMENTS

D764,941 S * 8/2016 Balganon Canela D9/705
 D786,697 S * 5/2017 Dytchkowskyj D9/708
 D808,820 S * 1/2018 Totani D9/707
 D814,941 S 4/2018 Conrardy

FOREIGN PATENT DOCUMENTS

JP	2000-153849 A	6/2000
JP	2009-208836 A	9/2009
JP	D1552632 S	6/2016
KR	1540 S	6/1997

OTHER PUBLICATIONS

Emballages, vol. 965, p. 147 (Nov. 2014) (Cited in parent U.S. Appl. No. 29/574,608, filed Aug. 17, 2016).
 Notice of Allowance dated Apr. 26, 2018, issued in U.S. Appl. No. 29/624,277 (10 pages).
 Notice of Allowance dated Apr. 26, 2018, issued in U.S. Appl. No. 29/624,282, (10 pages).
 Notice of Allowance dated May 11, 2018, issued in U.S. Appl. No. 29/624,284. (14 pages).

* cited by examiner

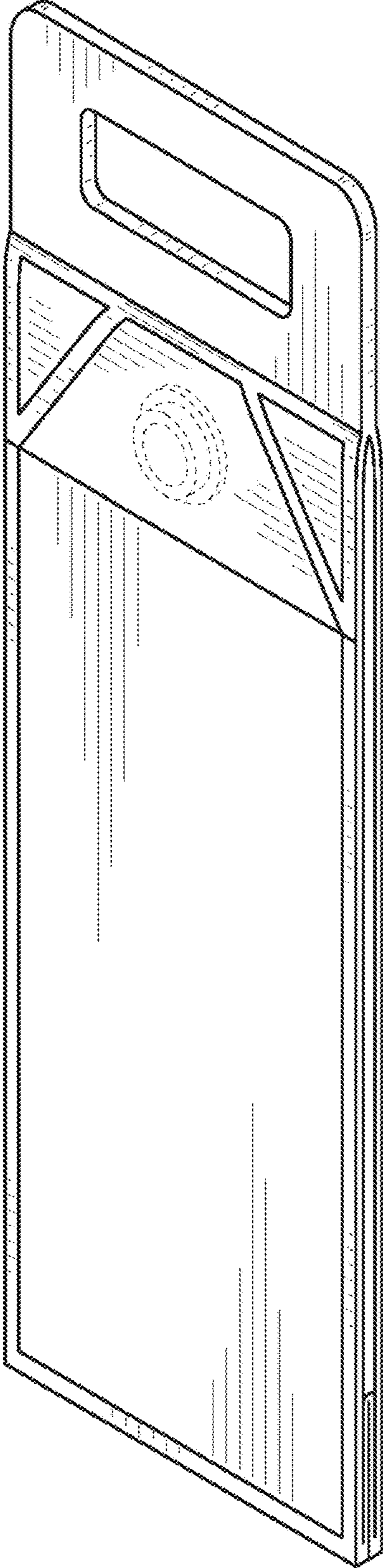

FIG. 1

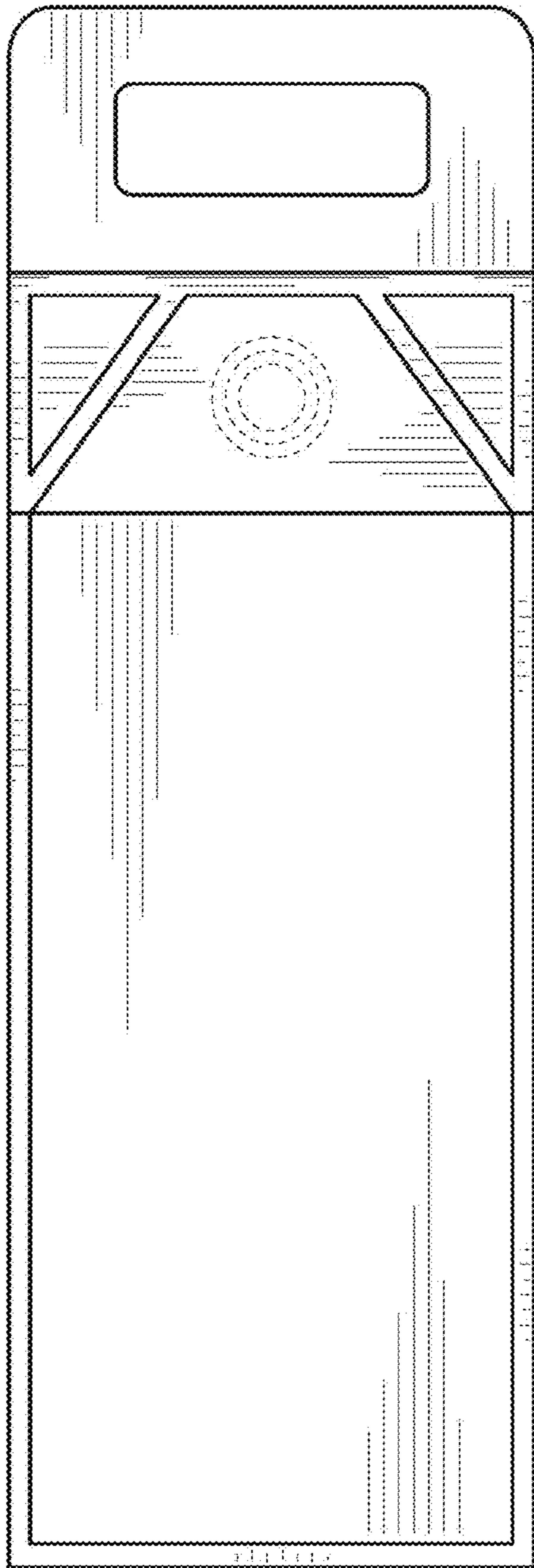

FIG. 2

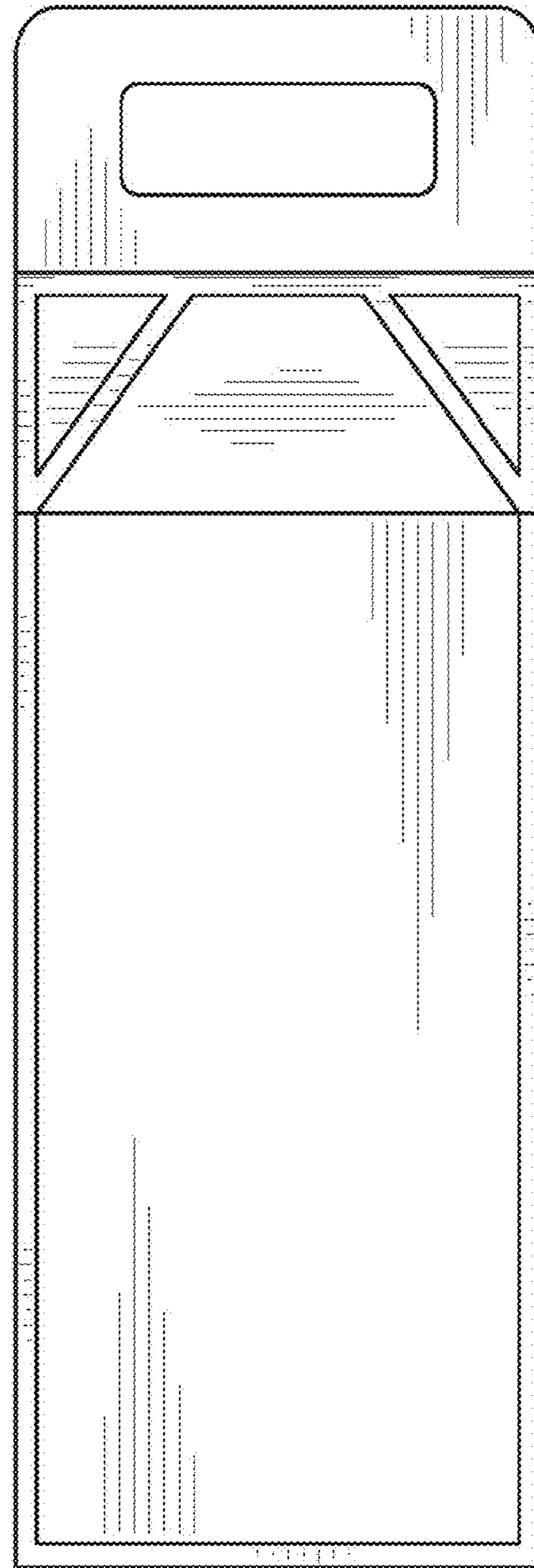

FIG. 3

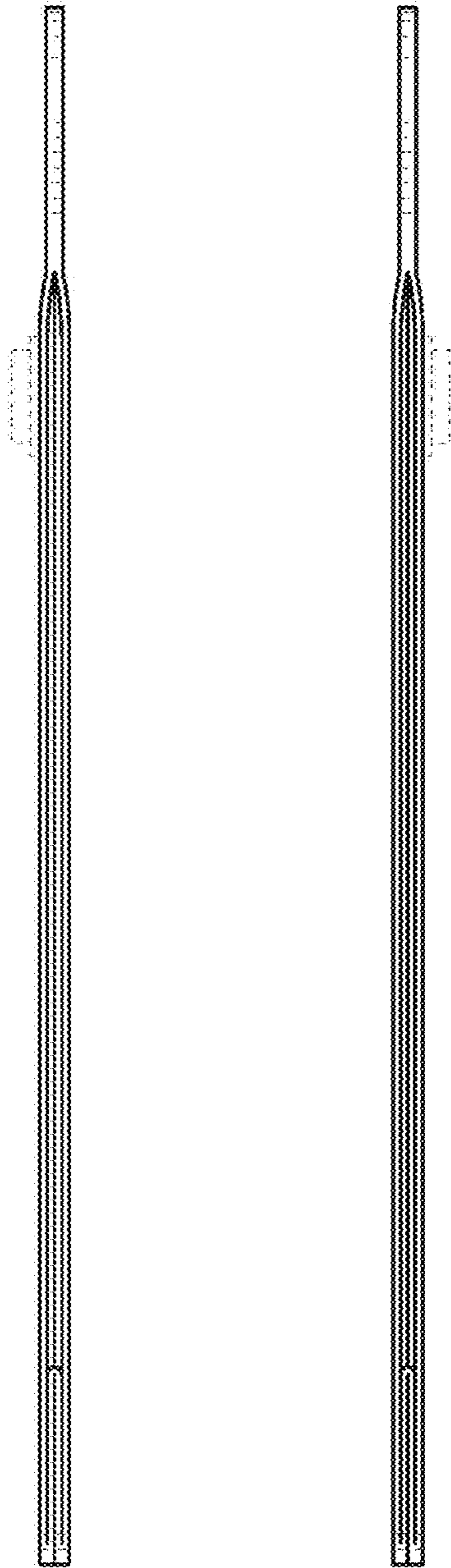

FIG. 4

FIG. 5

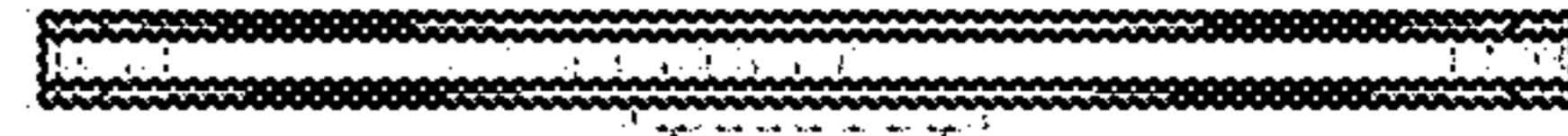

FIG. 6

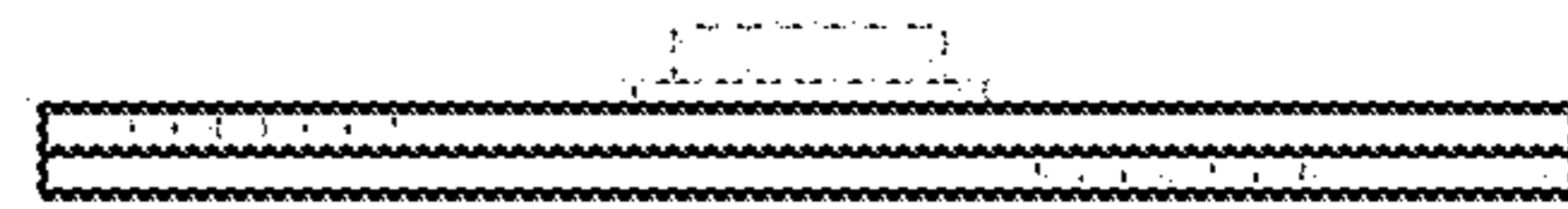

FIG. 7

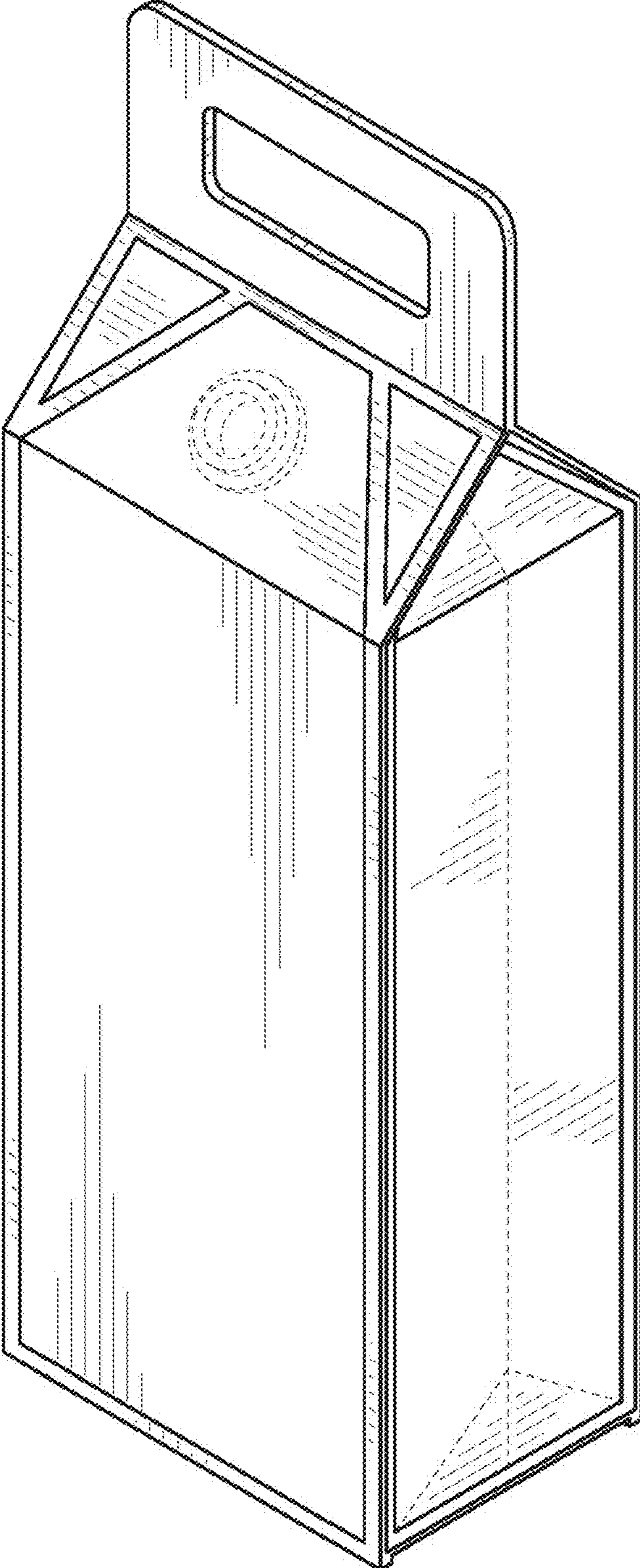

FIG. 8