



US00D823681S

(12) **United States Design Patent**
Hendricks et al.

(10) **Patent No.:** **US D823,681 S**
(45) **Date of Patent:** **** Jul. 24, 2018**

(54) **CONTAINER FOR A CONFECTIONERY**

(71) Applicant: **The Hershey Company**, Hershey, PA (US)

(72) Inventors: **William J. Hendricks**, Elizabethtown, PA (US); **Jonathon K. Markey**, Greensboro, NC (US); **Adam P. J. Frederick**, Greensboro, NC (US)

(73) Assignee: **The Hershey Company**, Hershey, PA (US)

(**) Term: **15 Years**

(21) Appl. No.: **29/532,184**

(22) Filed: **Jul. 2, 2015**

(51) **LOC (11) Cl.** **09-03**

(52) **U.S. Cl.**
USPC **D9/428**

(58) **Field of Classification Search**

USPC D9/414, 416, 418, 420, 423, 424, 425, D9/428, 430, 730; D3/201, 203.1, 273, D3/294, 298, 299, 300, 304, 314; D7/601, 502, 605, 701, 703, 708
CPC B65D 51/20; B65D 2543/00194; B65D 2543/00101; B65D 2577/205; B65D 51/18; B65D 2543/00425; B65D 2251/105; B65D 2543/00231; B65D 2571/0029; B65D 2519/00273

See application file for complete search history.

(56) **References Cited**

U.S. PATENT DOCUMENTS

3,412,890 A 11/1968 Rich
3,659,756 A 5/1972 Lancaster
D225,886 S * 1/1973 Winnetka et al. D7/586
D232,293 S * 8/1974 Christian et al. 220/574
4,059,201 A 11/1977 Foster
D248,357 S * 7/1978 Daenen D7/505

4,361,250 A 11/1982 Foster
D269,249 S * 6/1983 Cillario D9/424
D276,870 S * 12/1984 Gulotta D7/354
D277,724 S 2/1985 Daenen et al.

(Continued)

Primary Examiner — Lauren R Calve
(74) *Attorney, Agent, or Firm* — Design IP

(57) **CLAIM**

The ornamental design for a container for a confectionery, as shown and described.

DESCRIPTION

FIG. 1 is a front right perspective view of a first embodiment of a container for a confectionery showing our new design; FIG. 2 is a front elevation view thereof; FIG. 3 is a rear elevation view thereof; FIG. 4 is a left side elevation view thereof; FIG. 5 is a right side elevation view thereof; FIG. 6 is a top plan view thereof; FIG. 7 is a bottom plan view thereof; FIG. 8 is a front right perspective view of the container for a confectionery of FIG. 1, showing a portion of the lid portion thereof in an alternate position; FIG. 9 is a front right perspective view of a second embodiment of a container for a confectionery showing our new design; FIG. 10 is a front elevation view thereof; FIG. 11 is a rear elevation view thereof; FIG. 12 is a left side elevation view thereof; FIG. 13 is a right side elevation view thereof; FIG. 14 is a top plan view thereof; FIG. 15 is a bottom plan view thereof; and, FIG. 16 is a front right perspective view of the container for a confectionery of FIG. 9, showing a portion of the lid portion thereof in an alternate position. The broken lines appearing in FIGS. 1-16 represent environmental subject matter only and form no part of the claimed design.

1 Claim, 8 Drawing Sheets

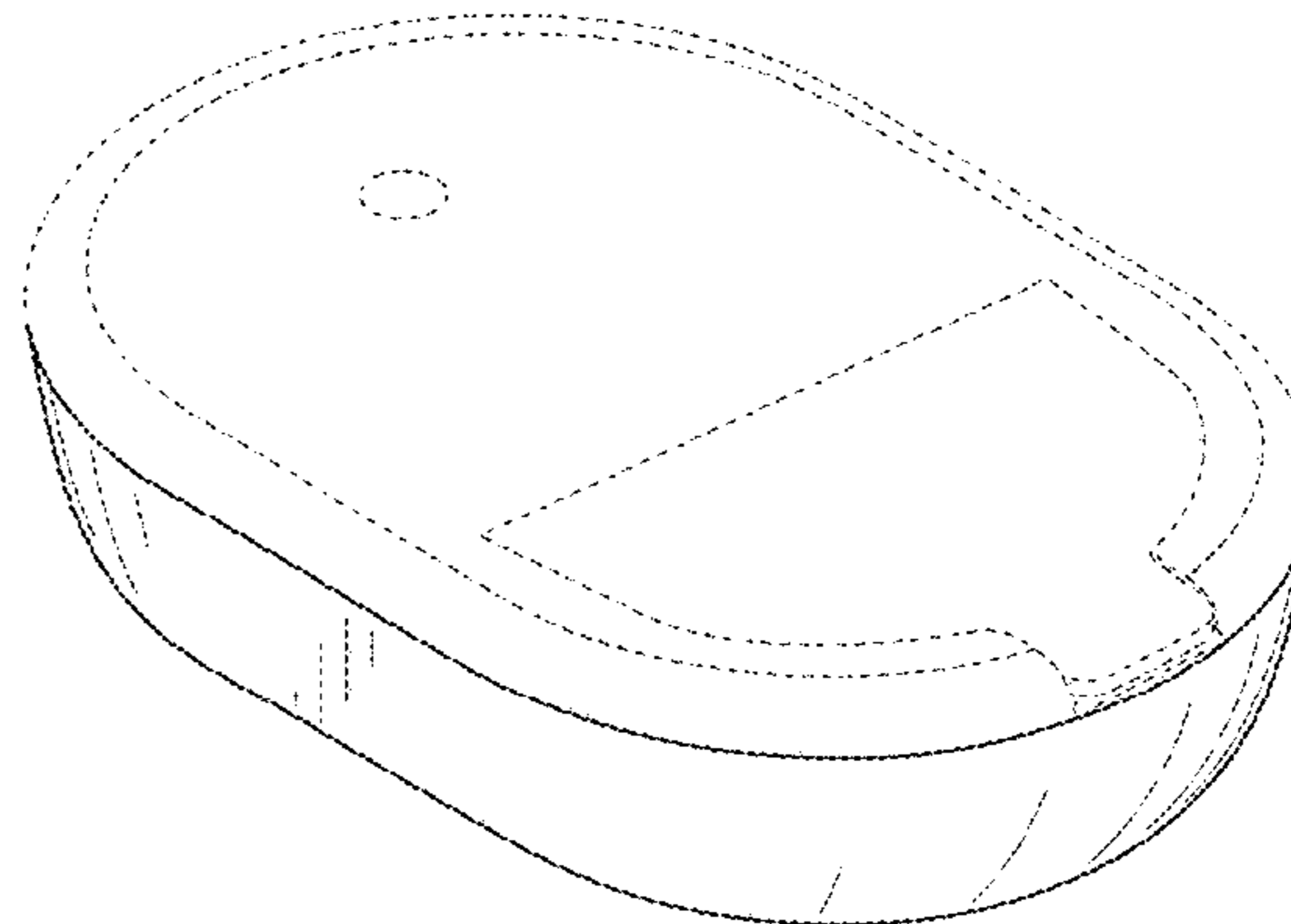
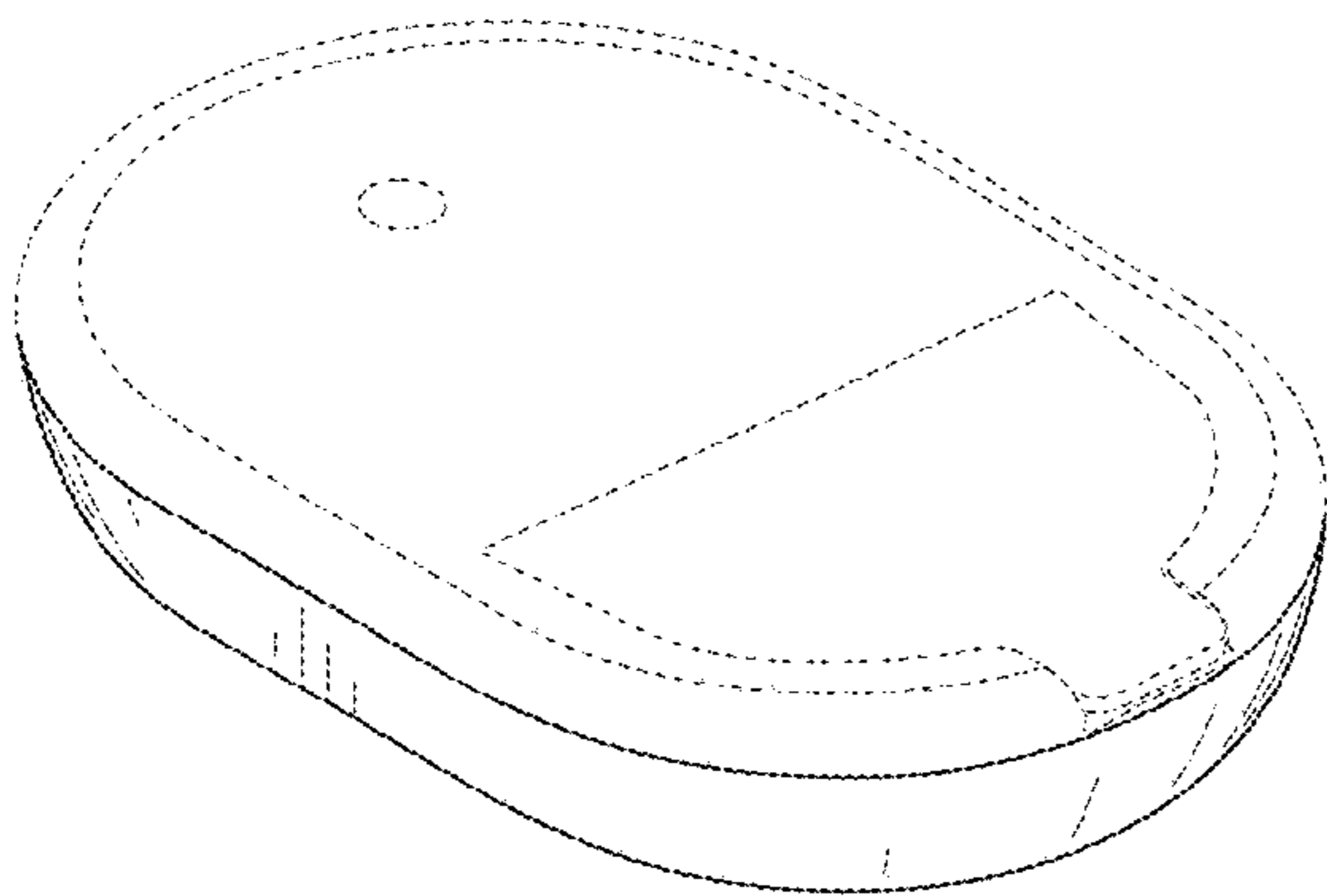

(56)

References Cited

U.S. PATENT DOCUMENTS

D278,602 S 4/1985 Rosenstein
 D280,058 S * 8/1985 Carlson D7/542
 D287,336 S * 12/1986 Roehrig D3/295
 D301,819 S * 6/1989 Watson D7/542
 4,898,292 A 2/1990 VerWeyst et al.
 D314,708 S 2/1991 DeCoster
 D321,137 S 10/1991 Hofmann et al.
 5,085,331 A 2/1992 Groya et al.
 5,139,181 A 8/1992 VerWeyst
 D331,877 S 12/1992 Robichaud et al.
 D335,085 S * 4/1993 Wacker D7/538
 5,339,993 A 8/1994 Groya et al.
 D367,878 S * 3/1996 Lee D18/17
 D383,671 S * 9/1997 Phillips D7/629
 5,799,838 A 9/1998 Miller
 D403,470 S 12/1998 Litton et al.
 5,927,535 A 7/1999 Goth
 D431,458 S 10/2000 Bried et al.
 D456,713 S 5/2002 Bried et al.
 D462,613 S 9/2002 Bried et al.
 D464,886 S 10/2002 Bried et al.
 D469,320 S * 1/2003 Pettaweebuncha D7/629
 D496,272 S * 9/2004 Jackson D7/602
 D527,627 S * 9/2006 Liebe D9/428
 D528,908 S * 9/2006 Faktorovich D9/424
 D586,557 S * 2/2009 Jalet D3/294
 D603,698 S 11/2009 VerWeyst

D610,409 S * 2/2010 Haas D7/586
 D634,115 S * 3/2011 Long, Jr. D3/201
 D645,738 S * 9/2011 Shiffer D9/425
 D647,397 S * 10/2011 Inaba D9/425
 D650,662 S * 12/2011 Shiffer D9/425
 D650,663 S * 12/2011 Shiffer D9/425
 D659,991 S * 5/2012 Long, Jr. D3/201
 D689,999 S * 9/2013 Viala D23/366
 D706,131 S * 6/2014 Brooks D9/428
 D706,621 S * 6/2014 Tuchrelo D9/425
 D706,622 S * 6/2014 Bischoff D9/425
 D712,703 S * 9/2014 Lipinski D7/602
 D731,304 S * 6/2015 Bischoff D9/425
 D732,345 S * 6/2015 Barbieri D7/509
 D738,110 S * 9/2015 Jiang D3/294
 D738,720 S * 9/2015 Yang D9/428
 D756,769 S * 5/2016 Tuchrelo D9/425
 D764,277 S * 8/2016 Irimia D9/428
 D764,871 S * 8/2016 Touchet D7/545
 D773,903 S * 12/2016 Shah D7/641
 D777,292 S * 1/2017 Schumacher D22/122
 9,533,803 B1 * 1/2017 Giraud B65D 50/06
 D792,743 S * 7/2017 Joseph D7/586
 D803,374 S * 11/2017 Patton D23/366
 2006/0118562 A1 * 6/2006 Plantz B65D 1/34
 220/521
 2006/0213916 A1 * 9/2006 Brown B65D 1/34
 220/780
 2017/0073145 A1 * 3/2017 Ishikawa B65D 81/3453

* cited by examiner

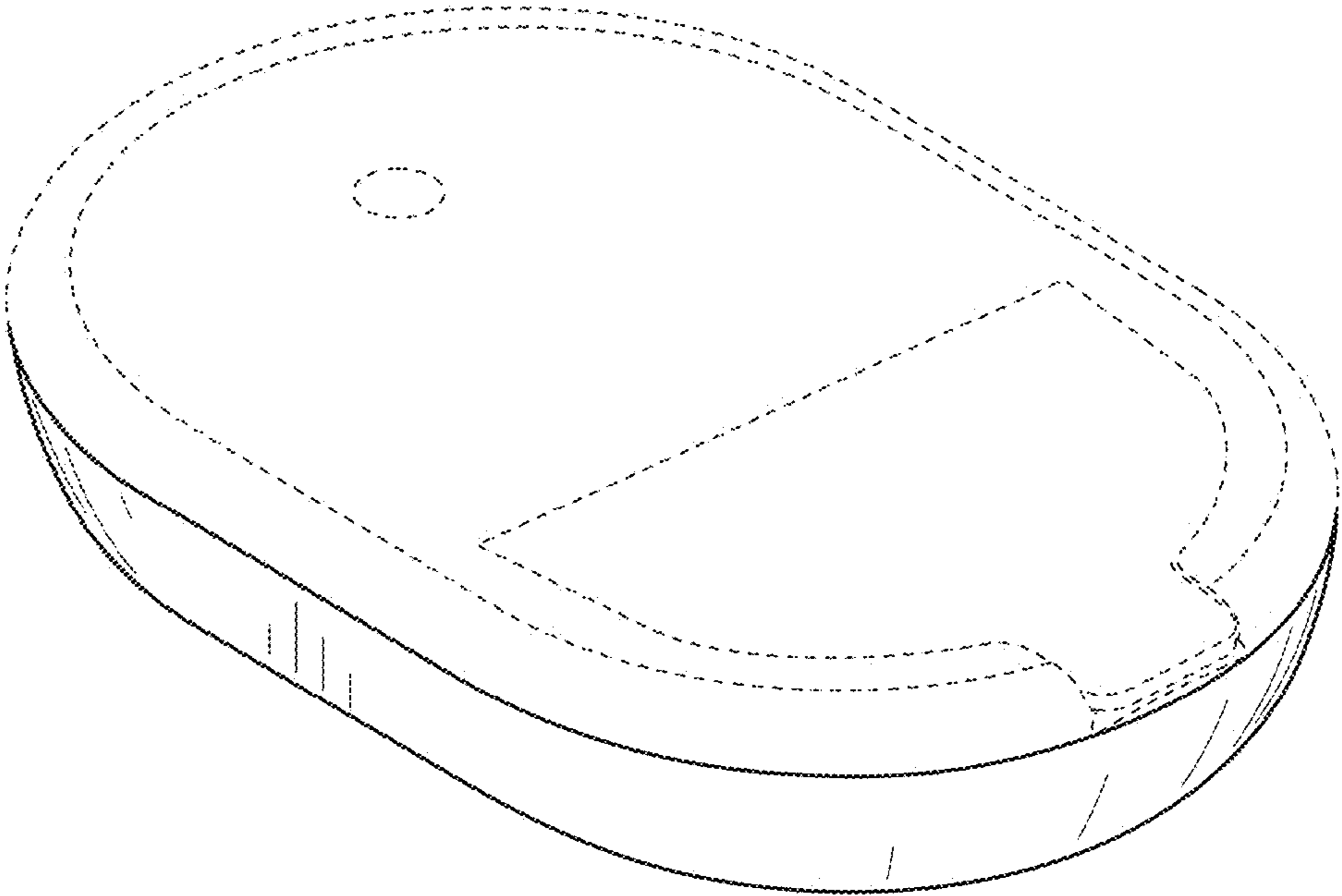

FIG. 1

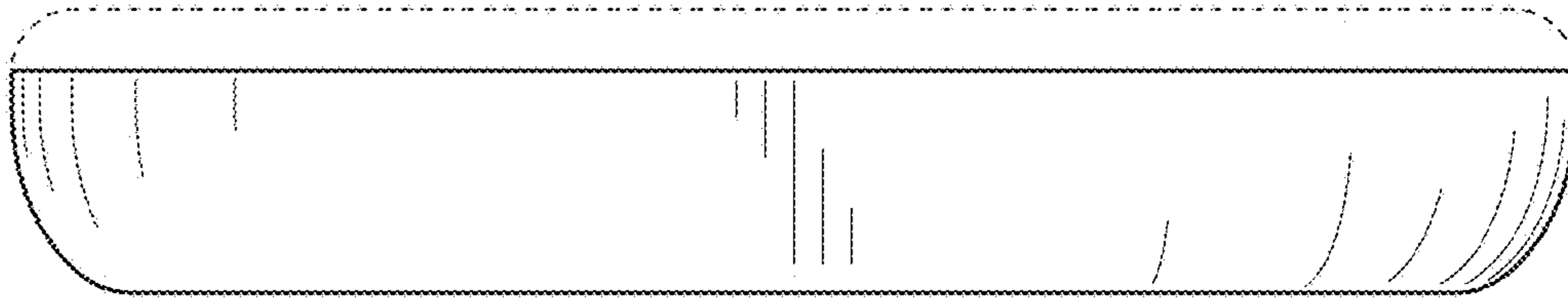

FIG. 2

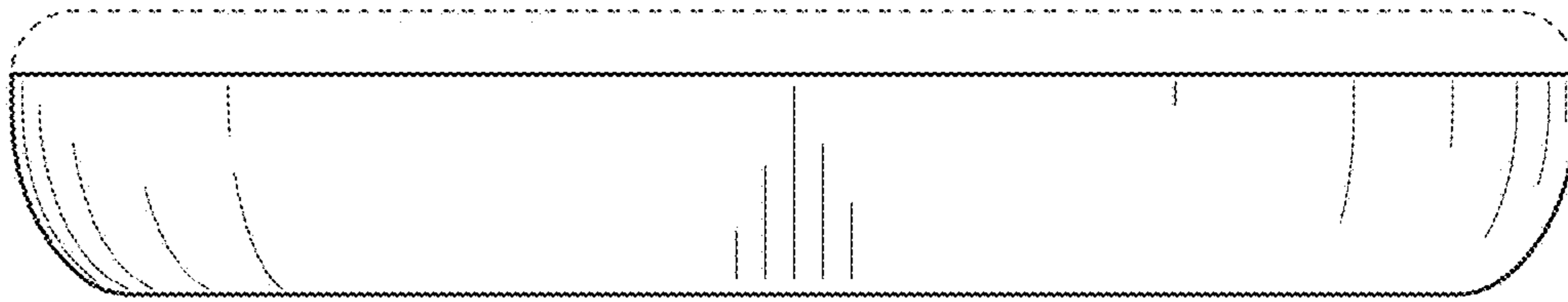

FIG. 3

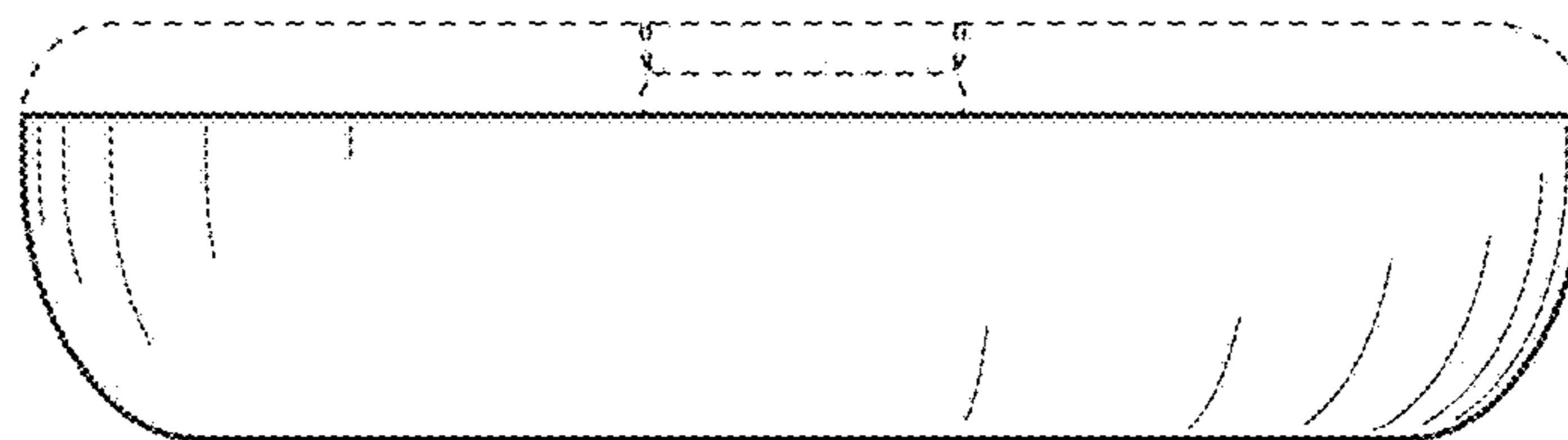

FIG. 4

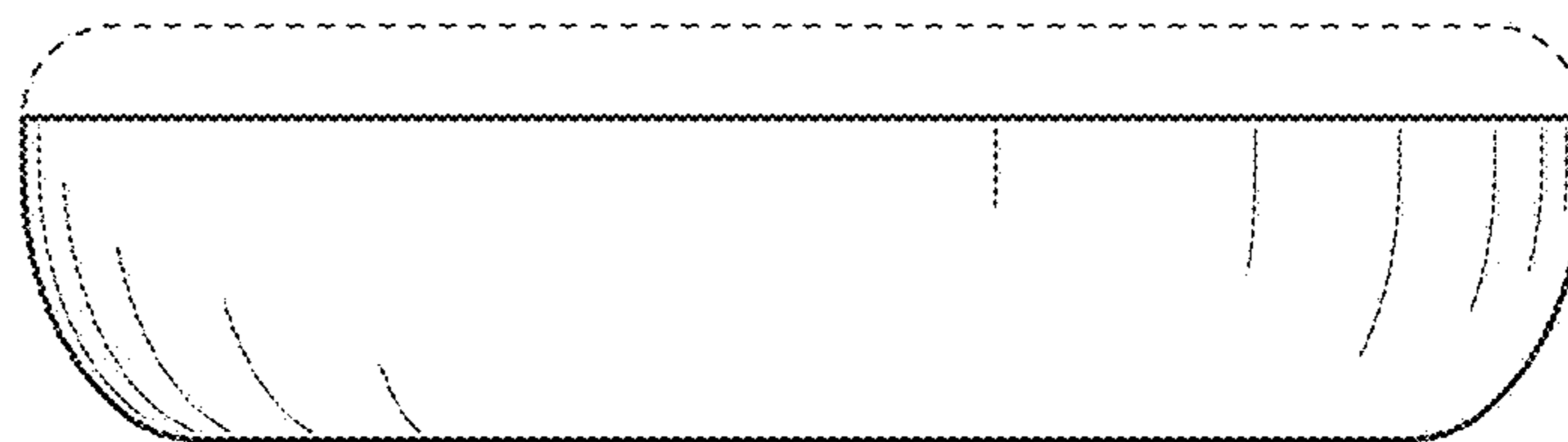

FIG. 5

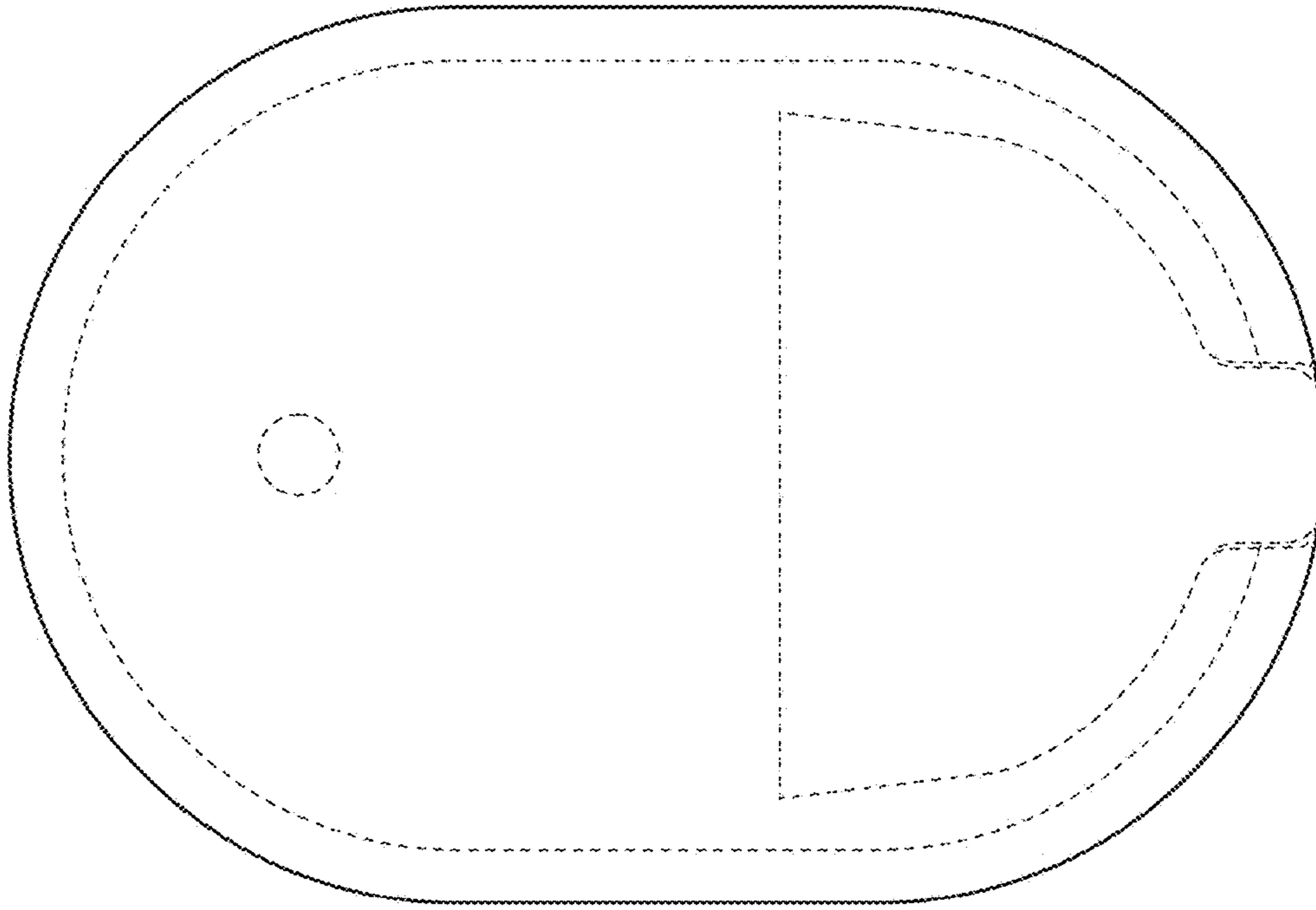

FIG. 6

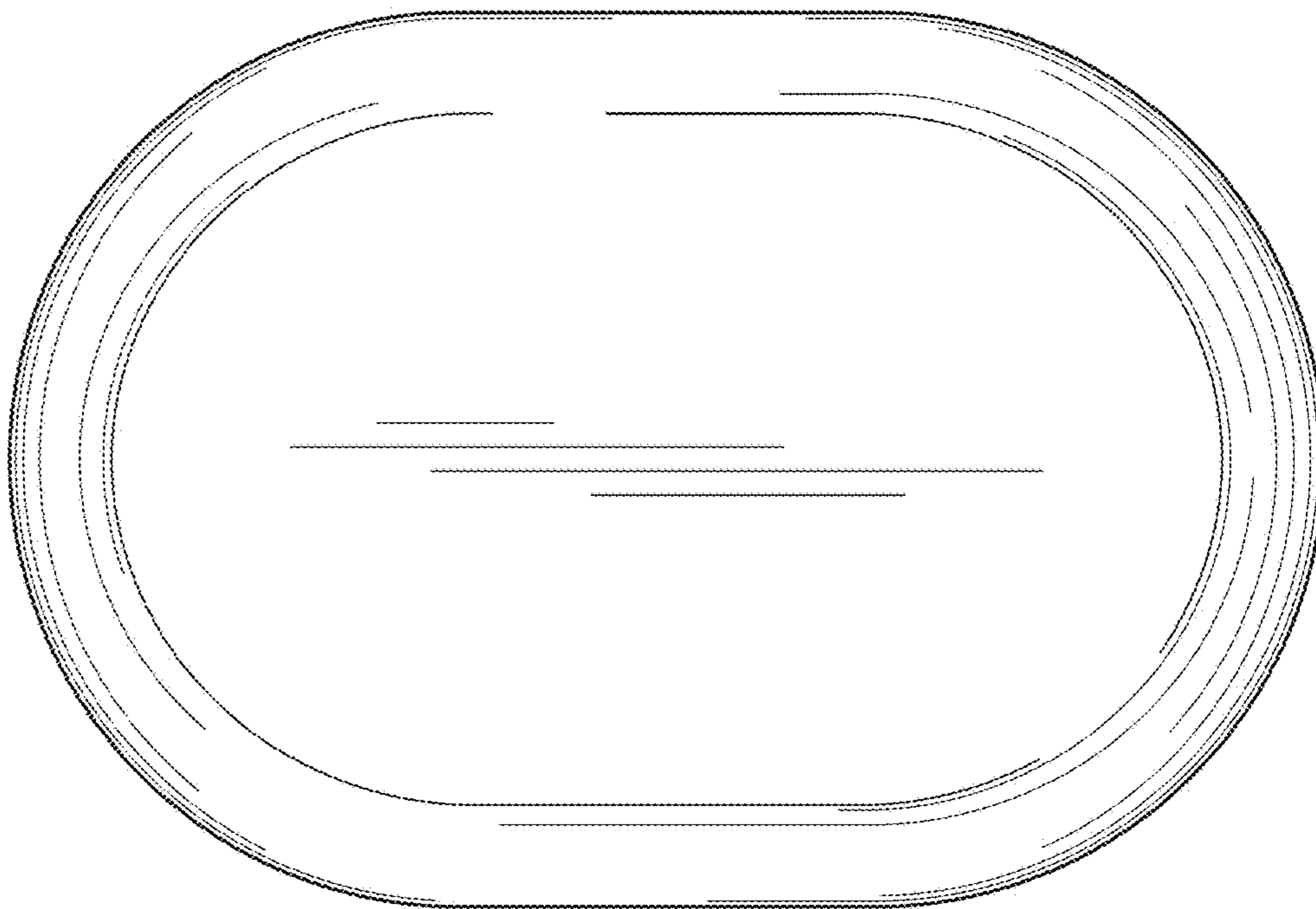

FIG. 7

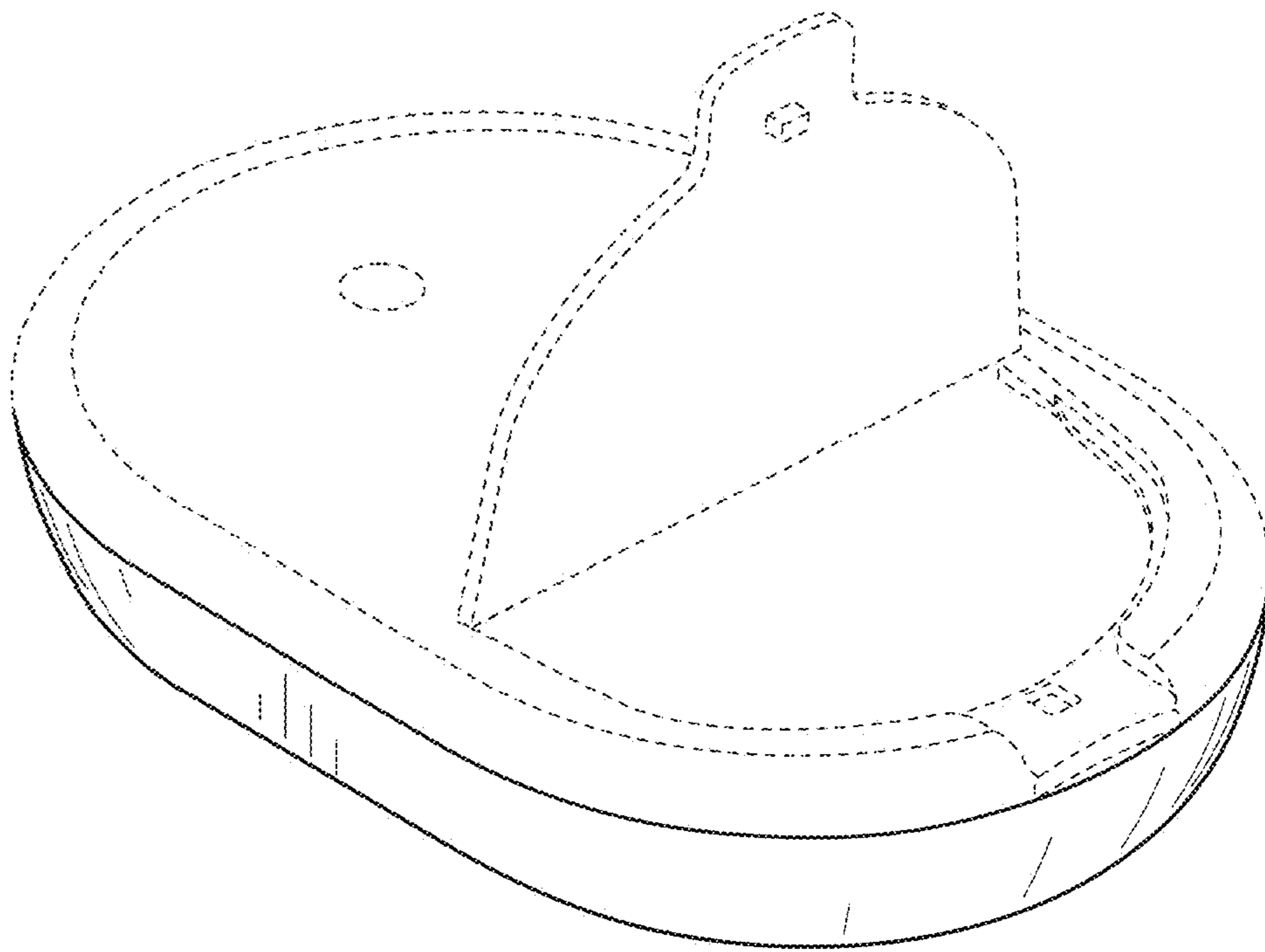

FIG. 8

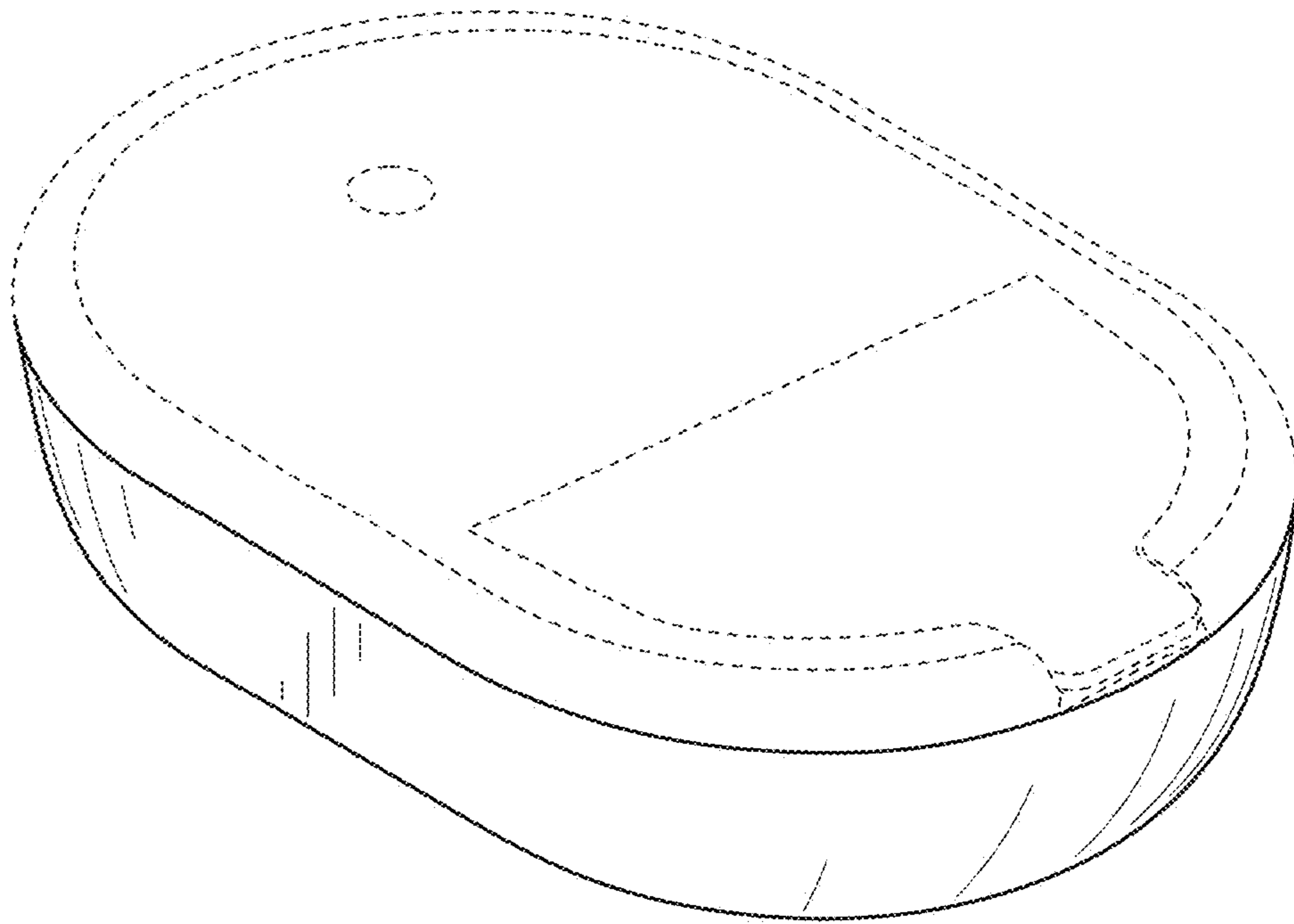

FIG. 9

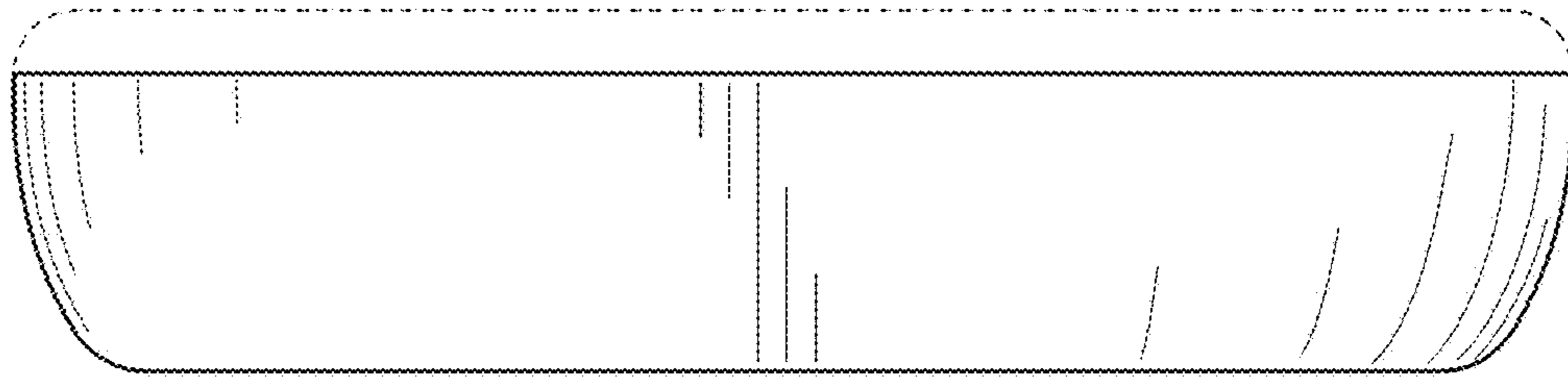

FIG. 10

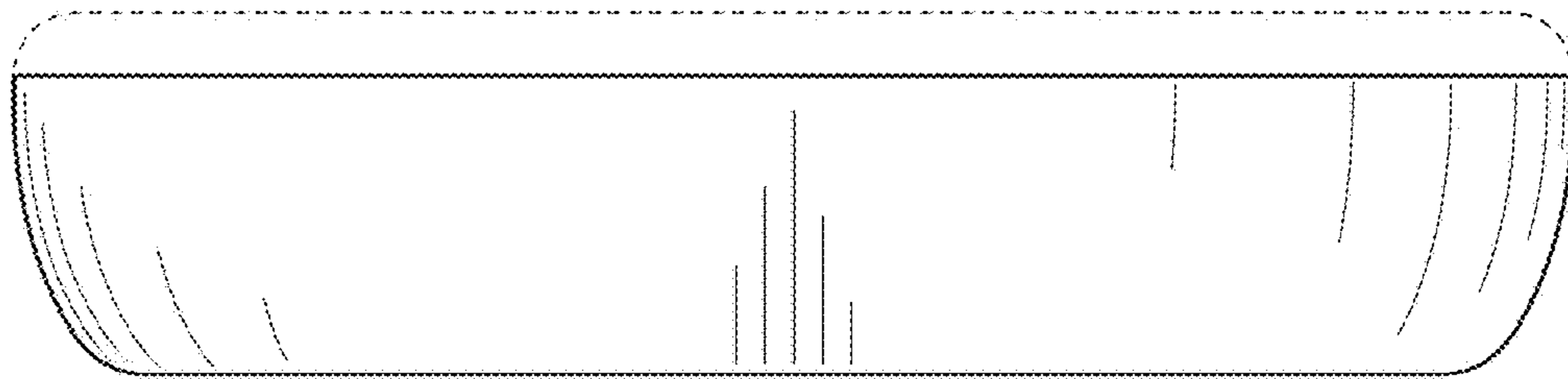

FIG. 11

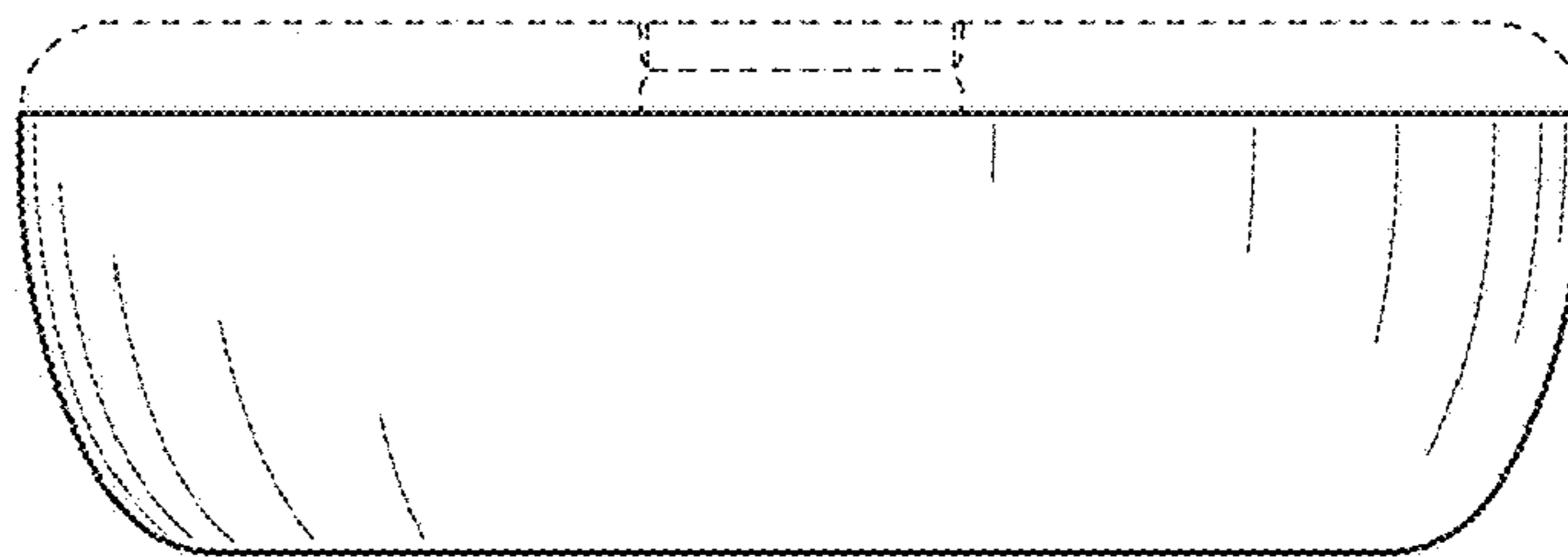

FIG. 12

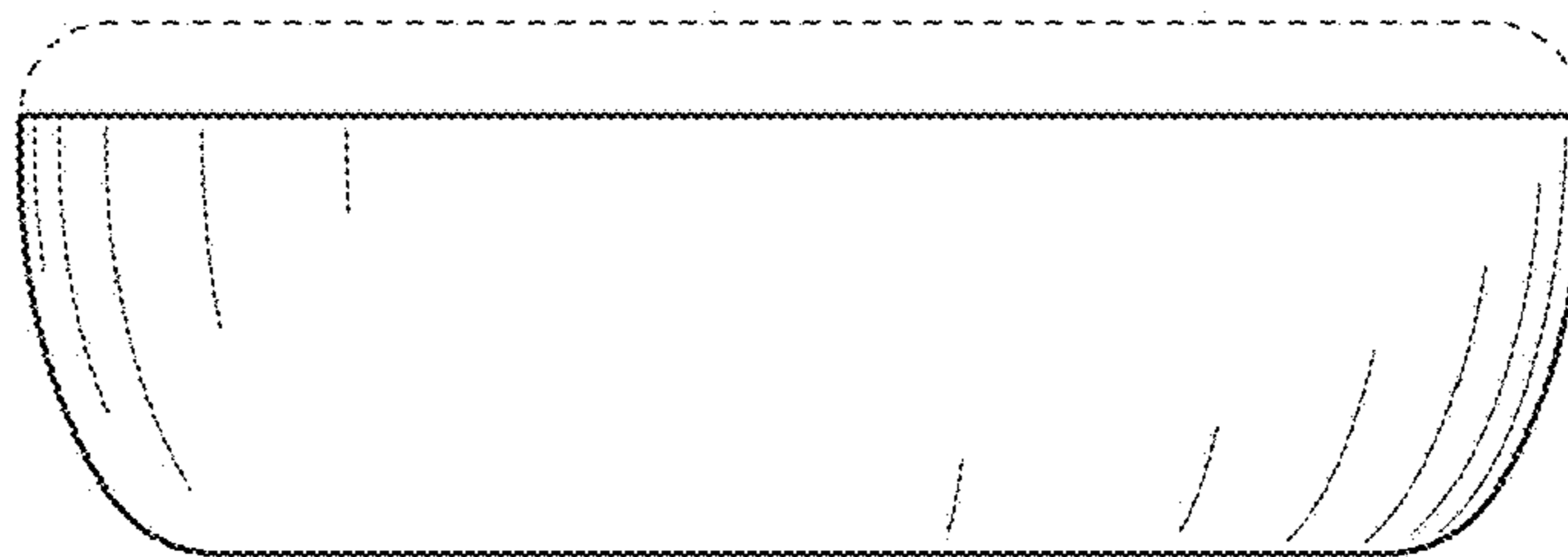

FIG. 13

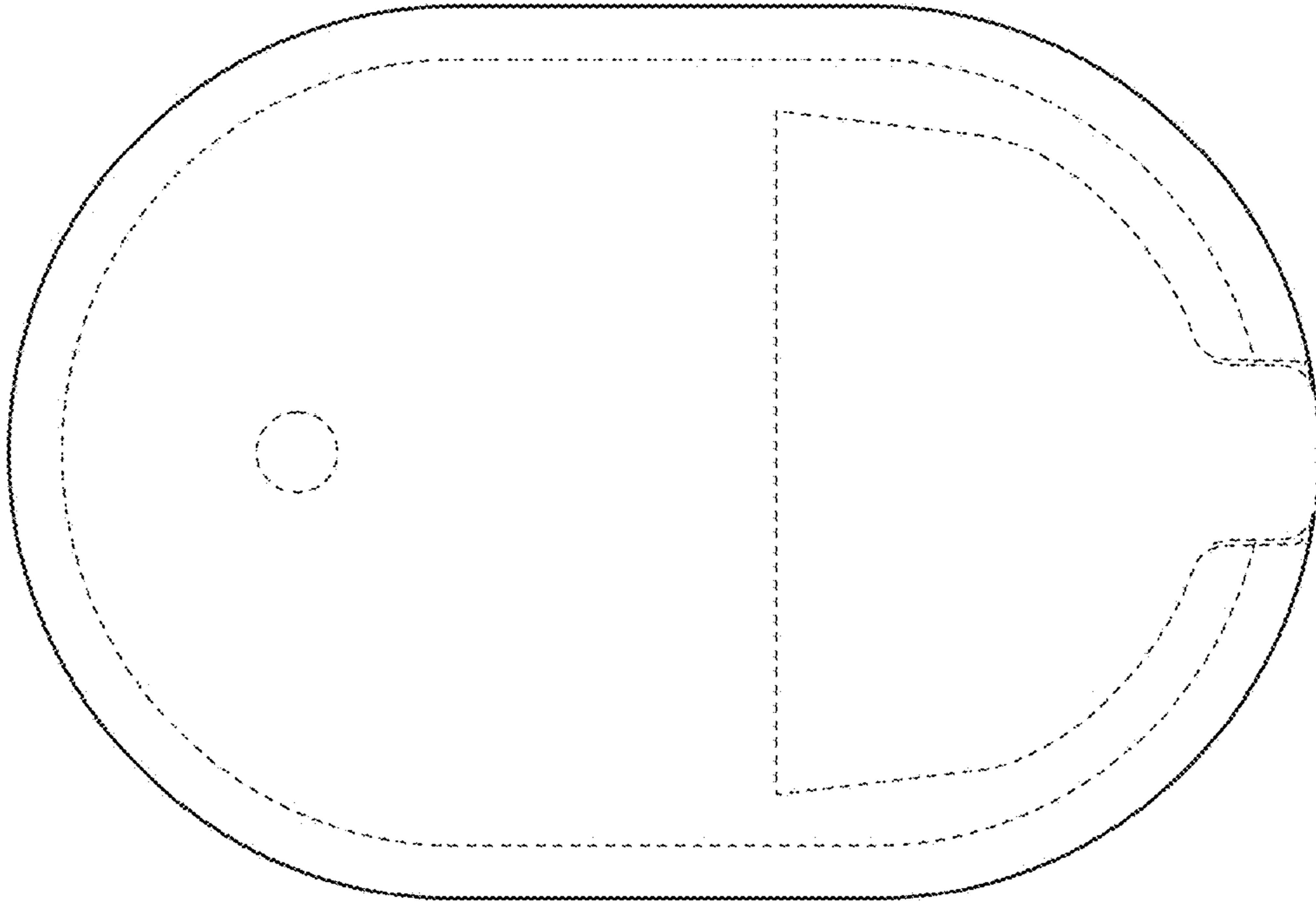

FIG. 14

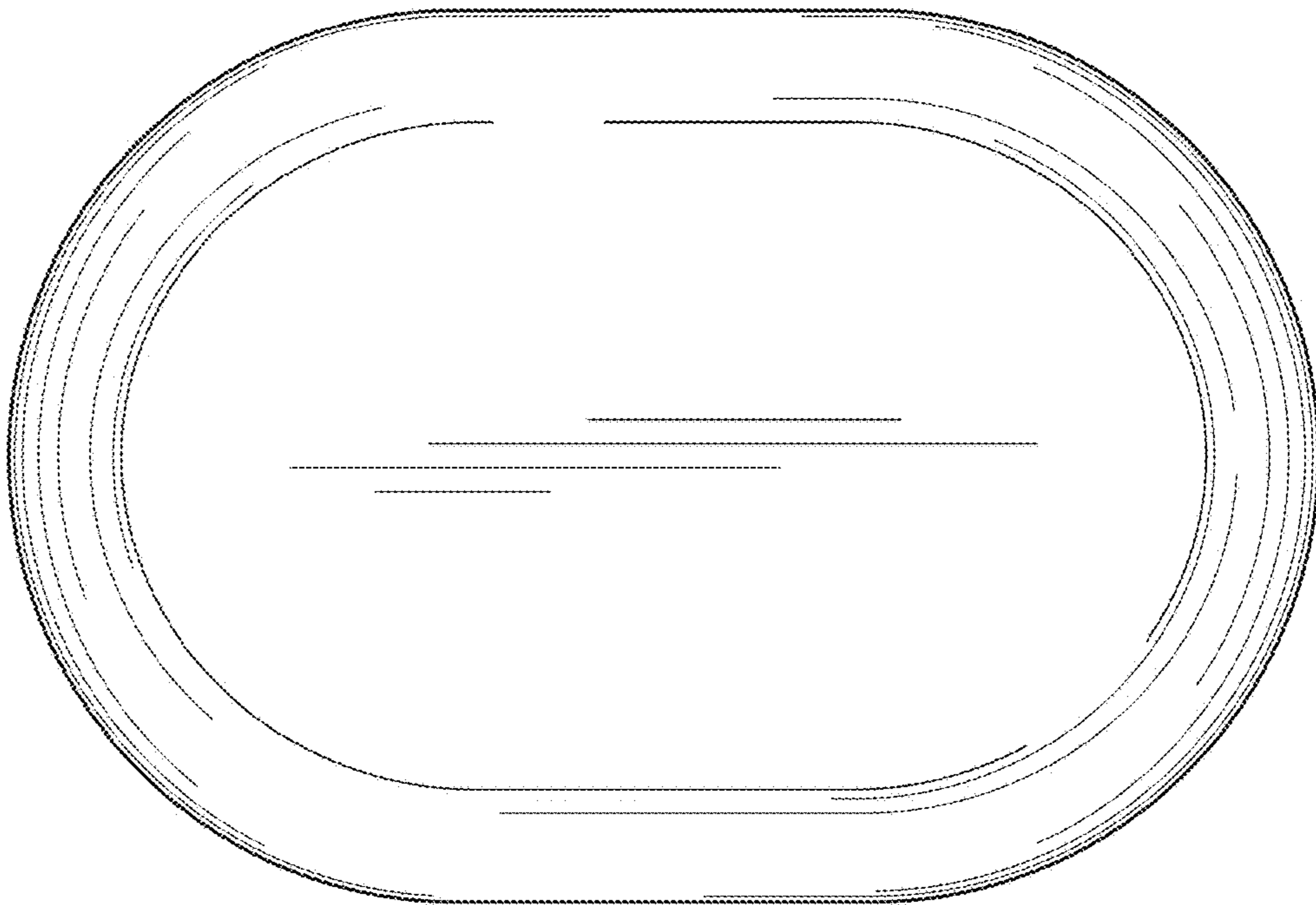

FIG. 15

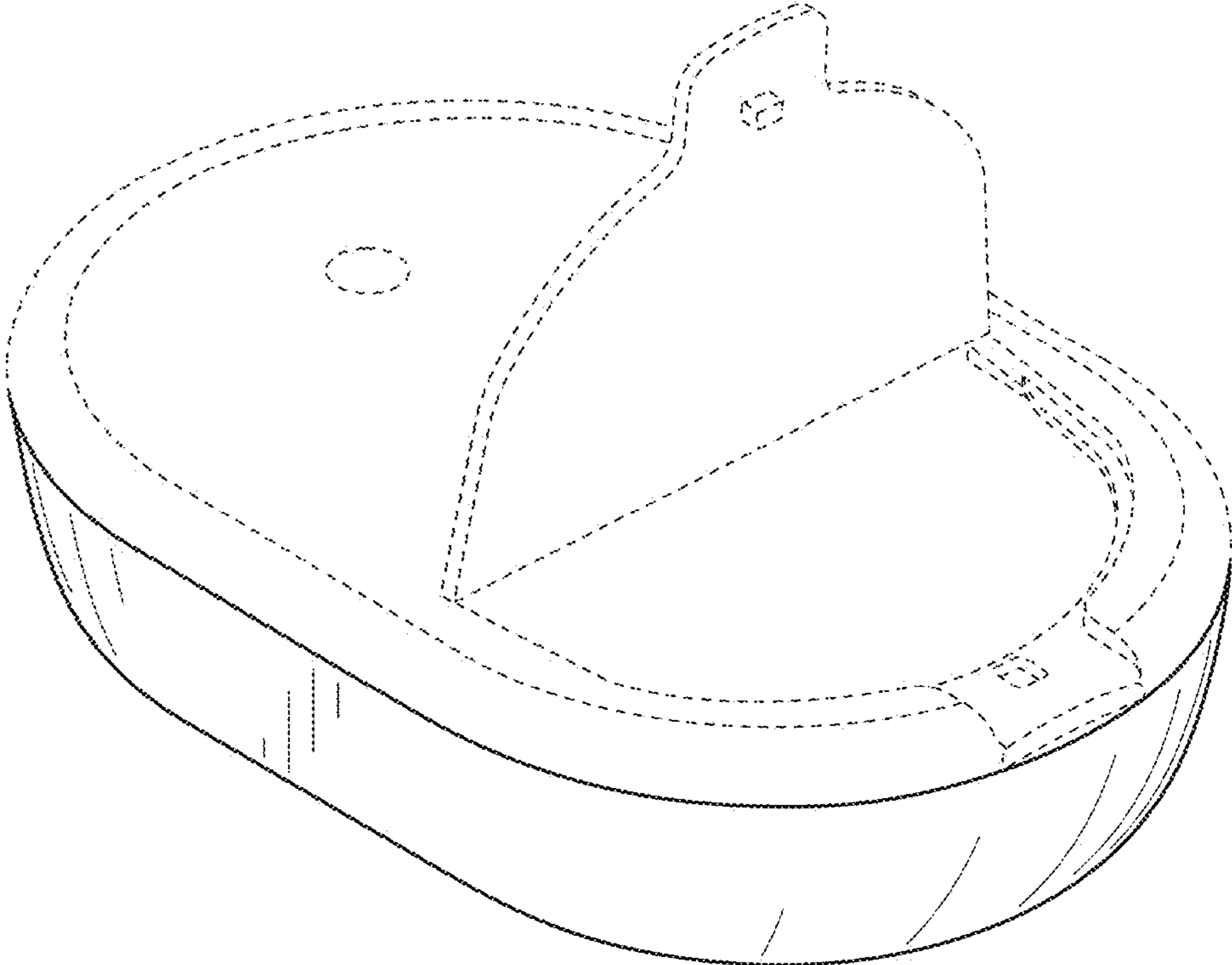

FIG. 16