



US00D823675S

(12) **United States Design Patent**  
**Dammann**

(10) **Patent No.:** **US D823,675 S**  
(45) **Date of Patent:** **\*\* Jul. 24, 2018**

- (54) **HANGING BRACKET WITH HOLE**
- (71) Applicant: **Eric Dammann**, Venice, FL (US)
- (72) Inventor: **Eric Dammann**, Venice, FL (US)
- (\*\*) Term: **15 Years**
- (21) Appl. No.: **29/617,489**
- (22) Filed: **Sep. 14, 2017**

7,637,065 B2 \* 12/2009 Ahren ..... E04B 9/225  
52/506.06  
D667,718 S \* 9/2012 Preda ..... D8/354  
D734,657 S \* 7/2015 Wu ..... D8/373  
D804,936 S \* 12/2017 Smith ..... D8/356  
2007/0290101 A1 12/2007 Paulig  
2014/0138503 A1\* 5/2014 Consaul ..... A47B 97/00  
248/214

\* cited by examiner

*Primary Examiner* — Brandon M Rosati  
*Assistant Examiner* — Harold E Blackwell, II

**Related U.S. Application Data**

- (63) Continuation of application No. 15/287,642, filed on Oct. 6, 2016.
- (51) **LOC (11) Cl.** ..... **08-05**
- (52) **U.S. Cl.**  
USPC ..... **D8/380**
- (58) **Field of Classification Search**  
USPC ..... D8/349, 353, 373, 371, 380; 248/57–59,  
248/62, 65, 69, 68.1, 74.1–74.4  
CPC ..... E04B 9/28; E04B 9/225  
See application file for complete search history.

(57) **CLAIM**

I claim the ornamental design for a hanging bracket with hole, as shown and described.

**DESCRIPTION**

FIG. 1 is a perspective view of a hanging bracket with hole showing my new design;  
FIG. 2 is a right-side elevation view thereof;  
FIG. 3 is a left-side elevation view thereof;  
FIG. 4 is a front elevation view thereof;  
FIG. 5 is a back elevation thereof;  
FIG. 6 is a top plan view thereof;  
FIG. 7 is a bottom plan view thereof; and,  
FIG. 8 is a perspective view thereof, showing the hanging bracket with hole installed in an exemplary ceiling structure. The broken lines showing portions of the ceiling structure are included for the purpose of illustrating environmental structure and form no part of the claimed design.

(56) **References Cited**

**U.S. PATENT DOCUMENTS**

- 4,315,611 A 2/1982 Hoop
- D378,988 S \* 4/1997 Brown ..... D8/380
- 6,543,751 B1 \* 4/2003 Spruill ..... E04F 11/1817  
256/65.04
- D494,051 S \* 8/2004 Klein ..... D8/373
- 6,941,597 B2 9/2005 Hampe
- D523,735 S \* 6/2006 Craine ..... D8/354
- D529,792 S \* 10/2006 Klein ..... D8/373

**1 Claim, 4 Drawing Sheets**

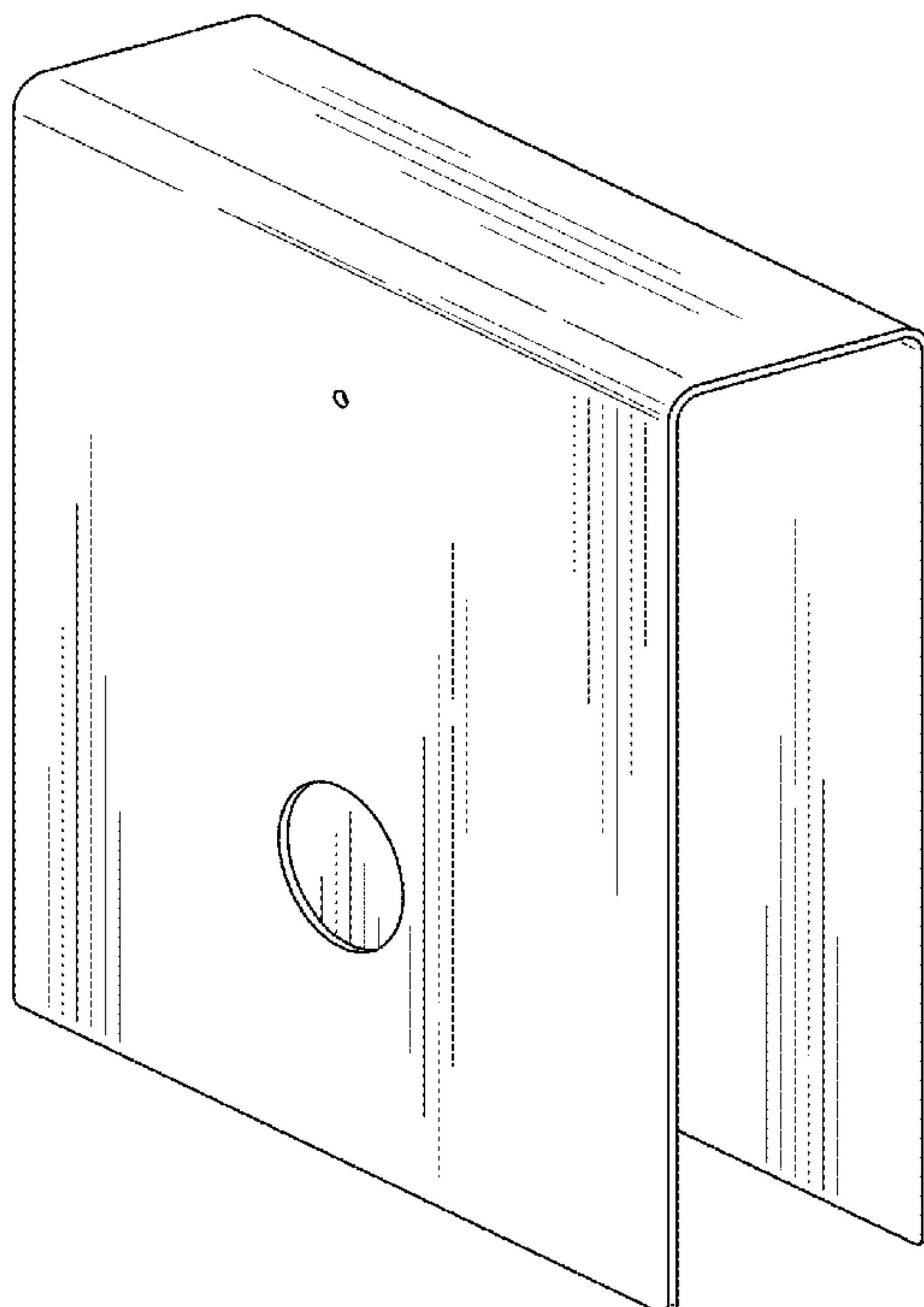

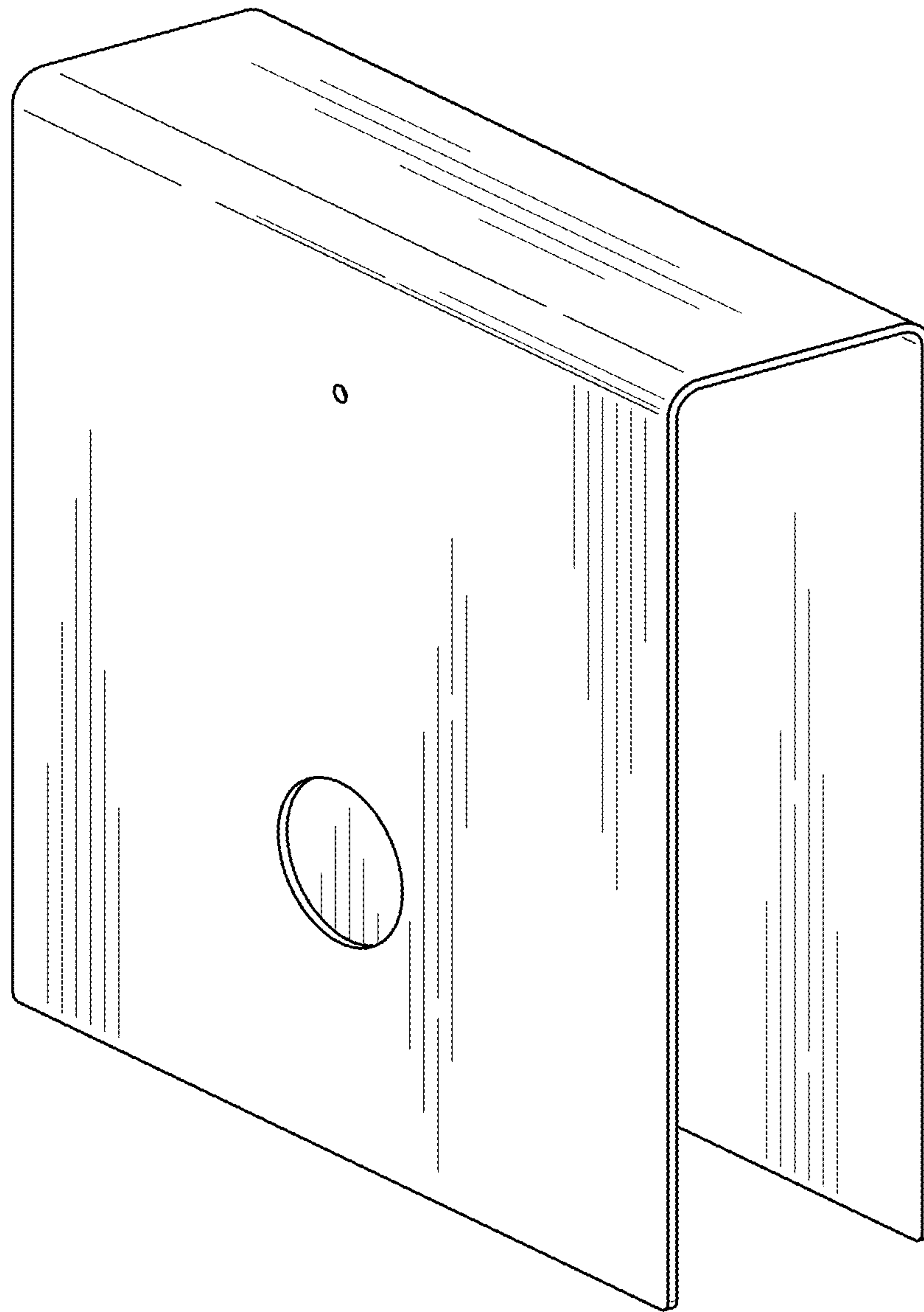

FIG. 1

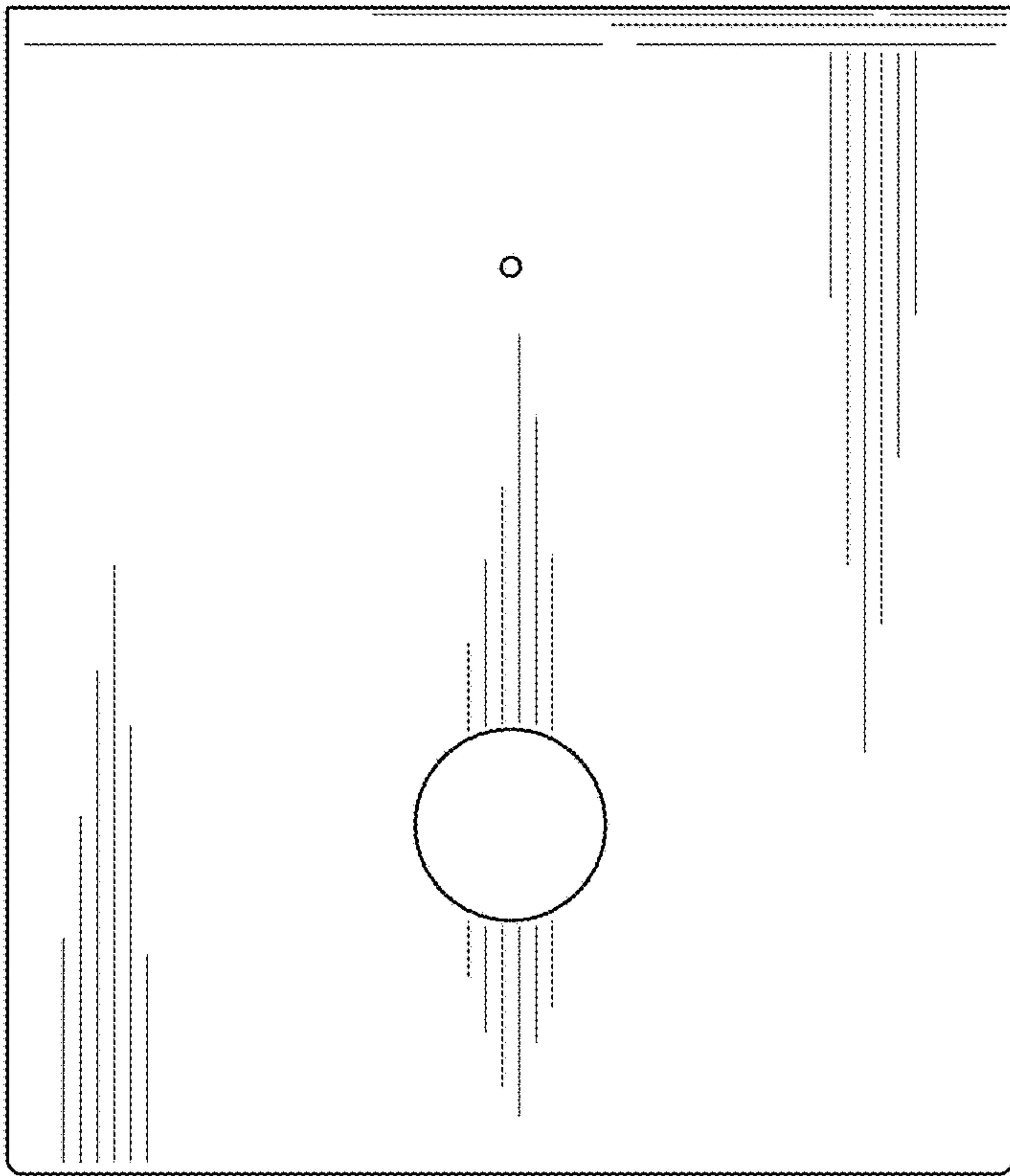

FIG. 2

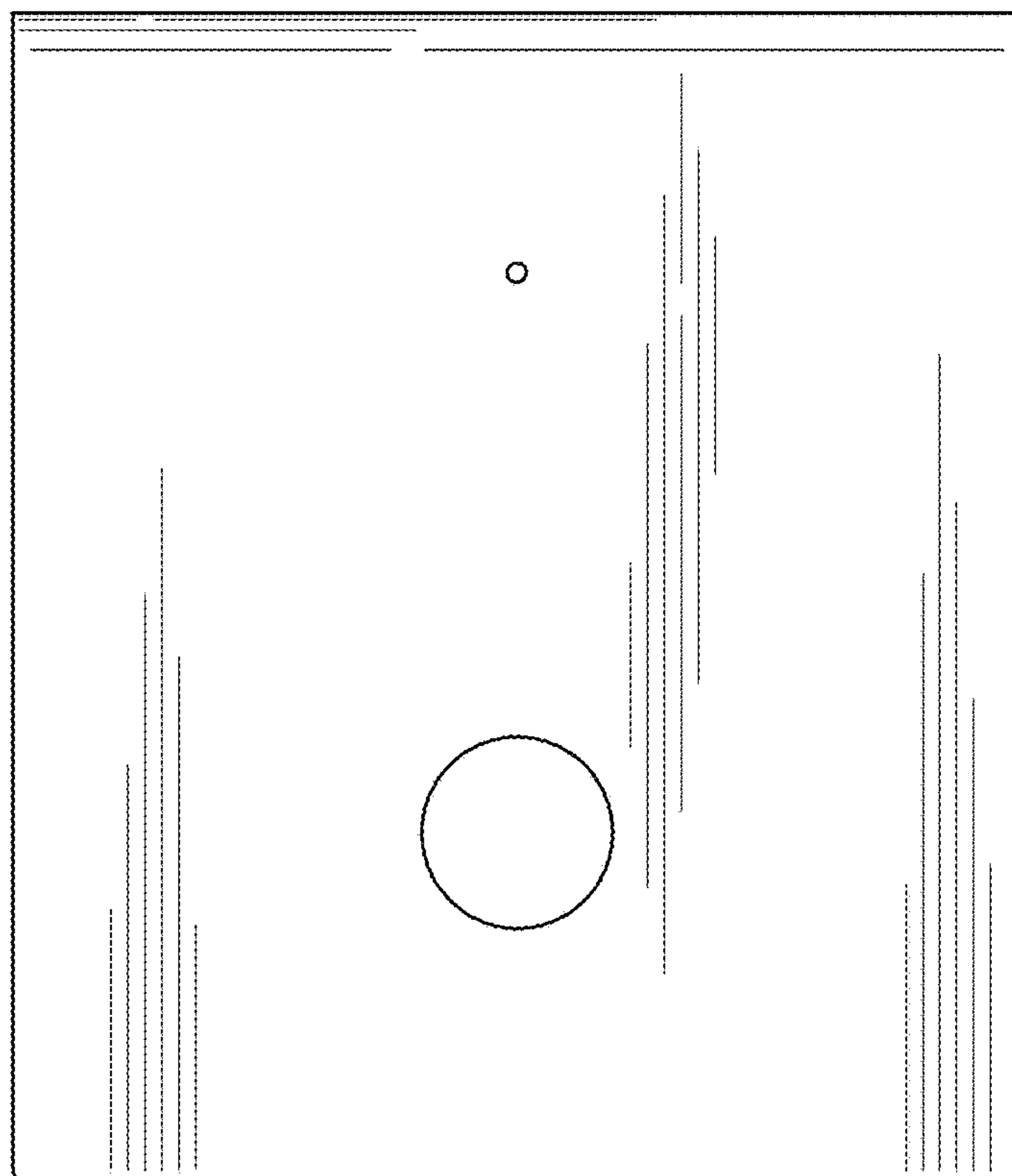

FIG. 3

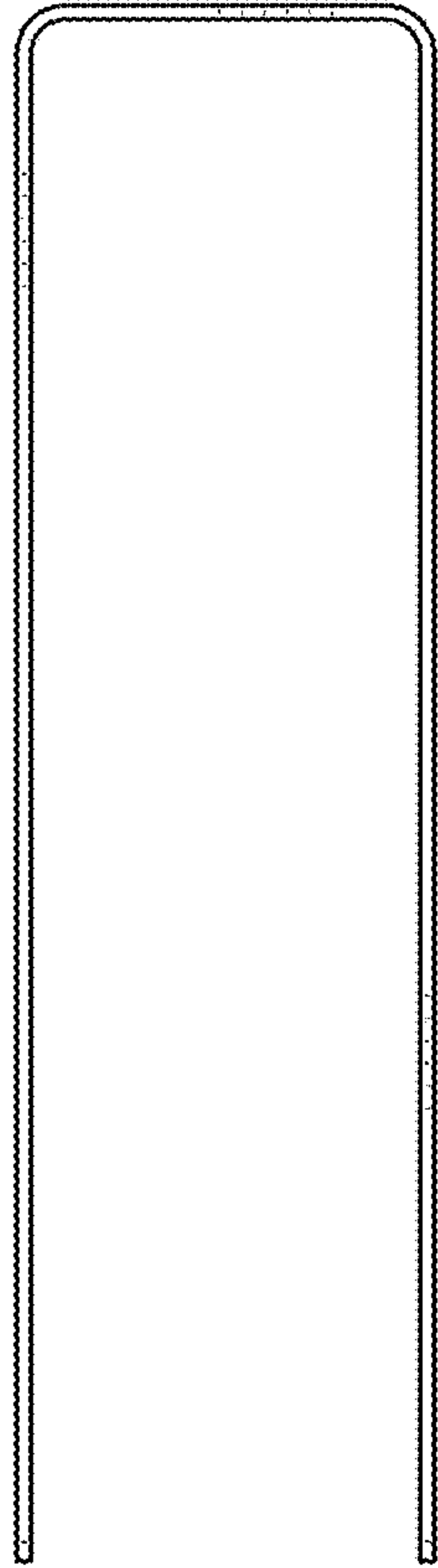

FIG. 4

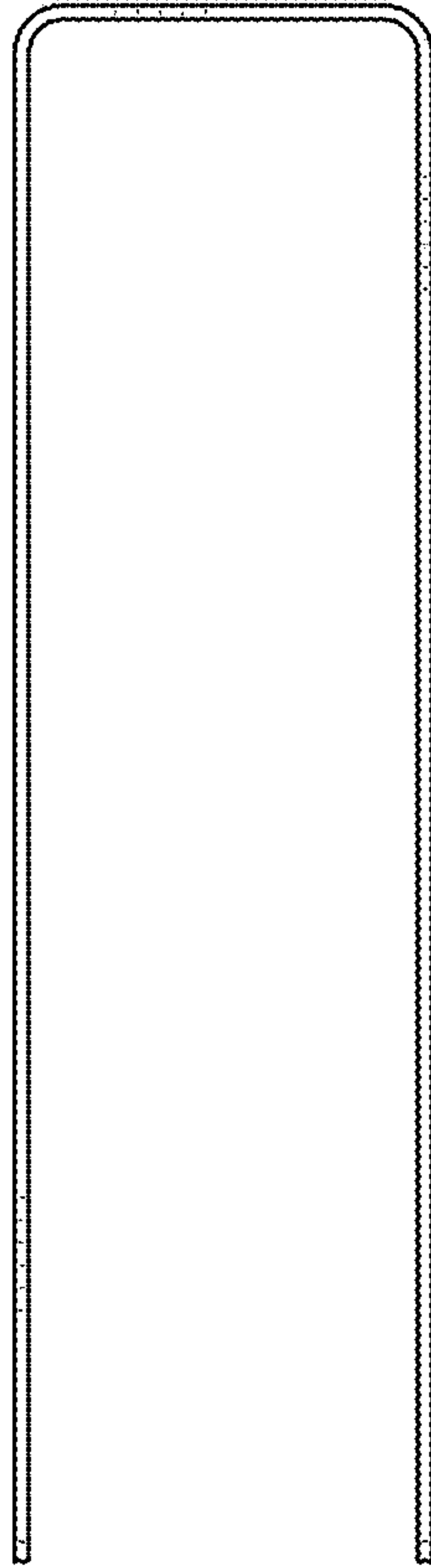

FIG. 5

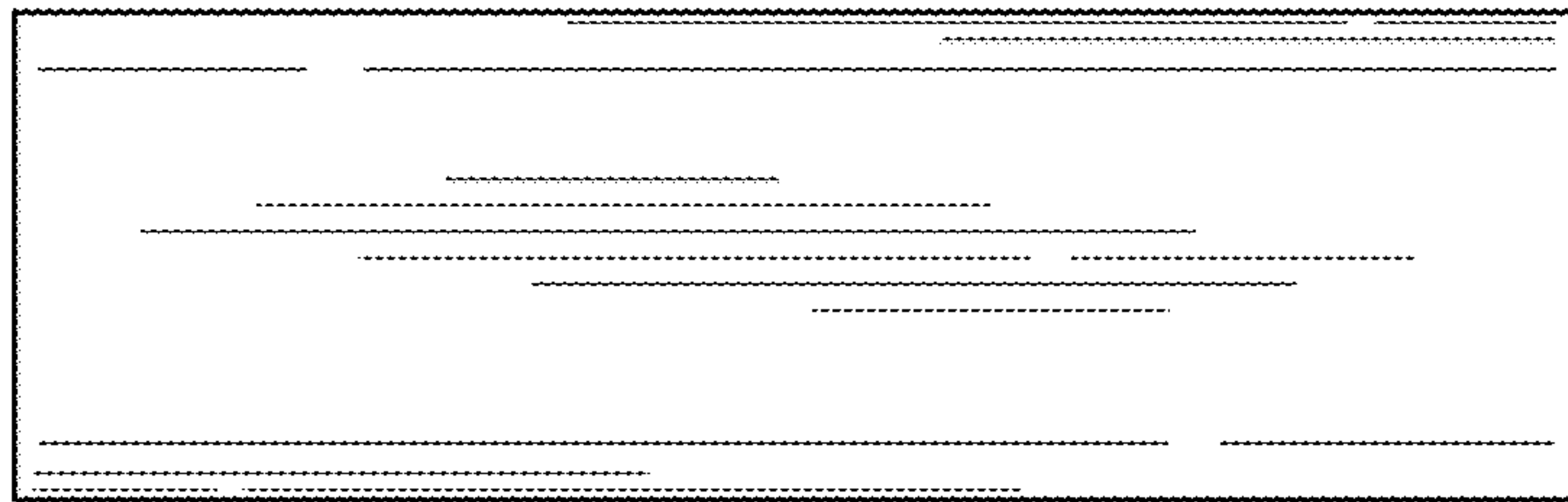

FIG. 6

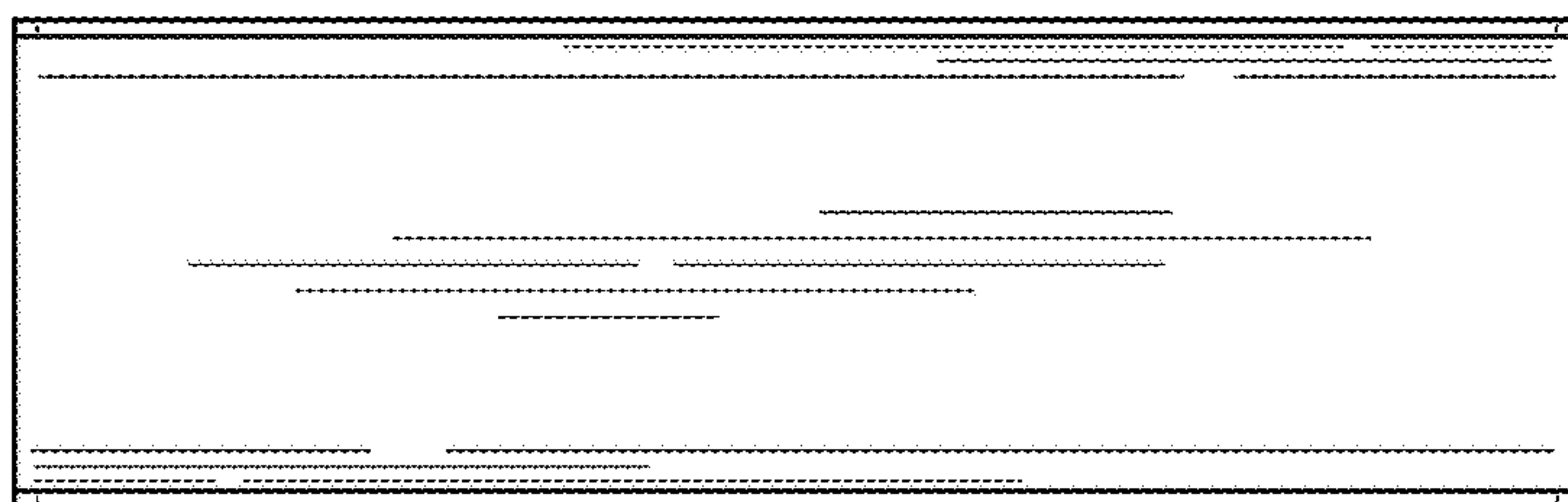

FIG. 7

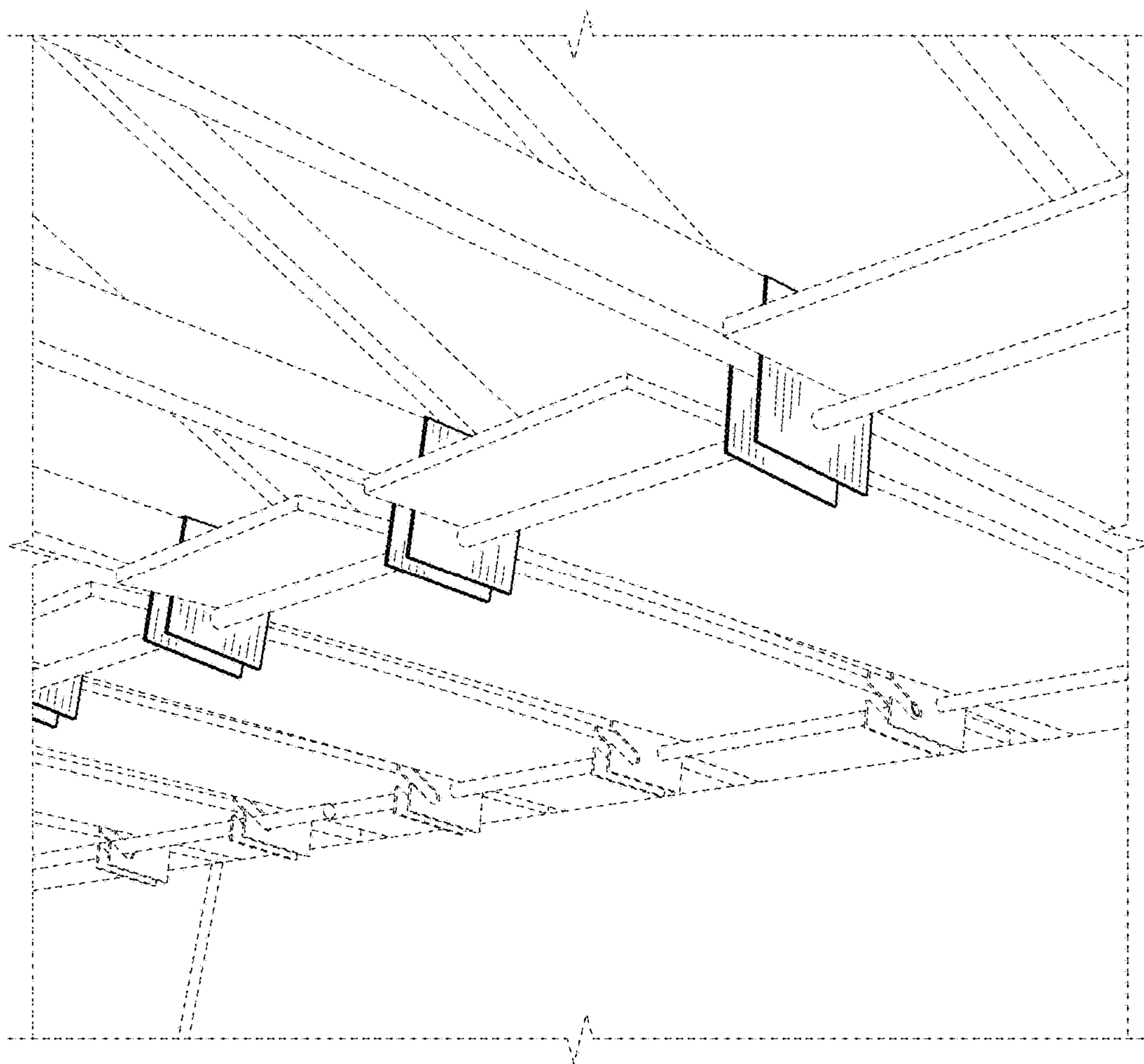

FIG. 8