



US00D823505S

(12) **United States Design Patent** (10) **Patent No.:** **US D823,505 S**
Claesson et al. (45) **Date of Patent:** **** Jul. 17, 2018**

(54) **LAMP**

(71) Applicant: **FONTANAARTE S.p.A.**, Corsico, Milan (IT)

(72) Inventors: **Marten Claesson**, Stockholm (SE); **Eero Koivisto**, Stockholm (SE); **Ola Rune**, Stockholm (SE)

(73) Assignee: **FONTANAARTE S.p.A.** (IT)

(**) Term: **15 Years**

(21) Appl. No.: **29/542,342**

(22) Filed: **Oct. 13, 2015**

(30) **Foreign Application Priority Data**

Apr. 10, 2015 (IT) MI2015O0060

(51) **LOC (11) Cl.** **26-02**

(52) **U.S. Cl.**
USPC **D26/37**

(58) **Field of Classification Search**

USPC D26/37, 38, 39, 40, 41, 46, 51; 362/157, 362/158, 194-196, 200-208, 253
CPC F21L 2003/00; F21L 4/00; F21L 4/005; F21L 4/02; F21L 4/025; F21L 4/027; F21L 4/04; F21L 4/08; F21L 2005/00; F21L 7/00; F21L 11/00; F21L 13/00; F21L 13/04; F21L 13/08; F21L 14/02; F21L 17/00; F21L 19/00

See application file for complete search history.

(56) **References Cited**

U.S. PATENT DOCUMENTS

4,947,476 A * 8/1990 Seaburg F21L 7/00 15/220.4
D351,244 S * 10/1994 Lee D26/46

D470,615 S * 2/2003 Janice D26/39
D633,240 S * 2/2011 Cheng D26/60
D634,460 S * 3/2011 Seal D26/37
D674,944 S * 1/2013 Bertken D26/39
D723,202 S * 2/2015 Windom D26/39
D747,021 S * 1/2016 Hunnewell D26/39
D756,552 S * 5/2016 Kunzendorf D26/39

* cited by examiner

Primary Examiner — Lakiya Rogers

Assistant Examiner — Carissa C Fitts

(74) *Attorney, Agent, or Firm* — Saidman DesignLaw Group, LLC

(57) **CLAIM**

The ornamental design for a lamp, as shown and described.

DESCRIPTION

FIG. 1 is a perspective view of a lamp showing our new design;
FIG. 2 is another perspective view thereof;
FIG. 3 is a front view thereof;
FIG. 4 is a rear view thereof;
FIG. 5 is a right side view thereof, the left side view being a mirror image;
FIG. 6 is a top view thereof; and,
FIG. 7 is a bottom view thereof.

The drawings include CAD lines that represent contour and not surface decoration.

The drawings include surface shading which represents contour and not surface ornamentation.

The broken lines illustrate structure or features which form no part of the claimed design.

1 Claim, 4 Drawing Sheets

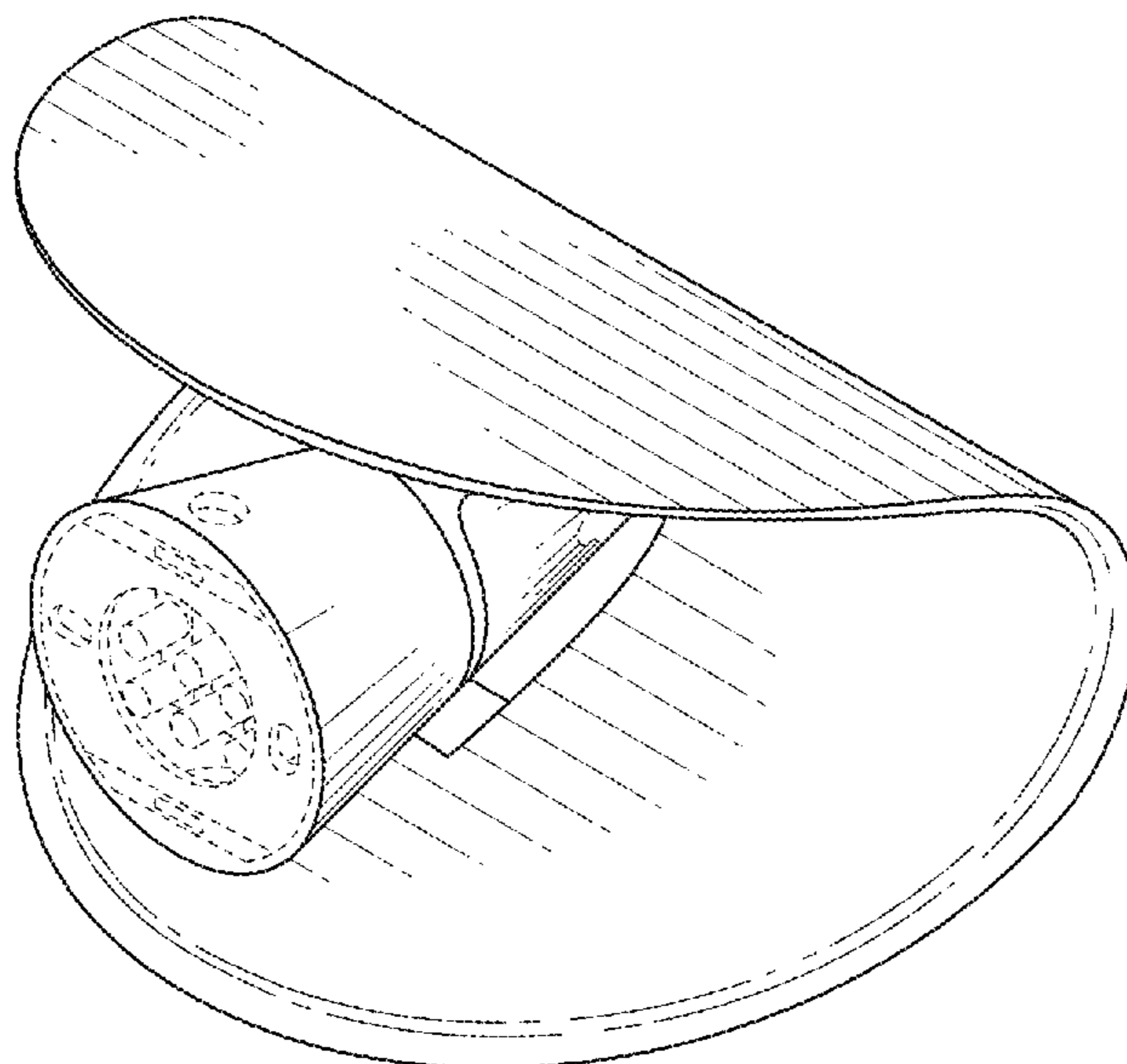

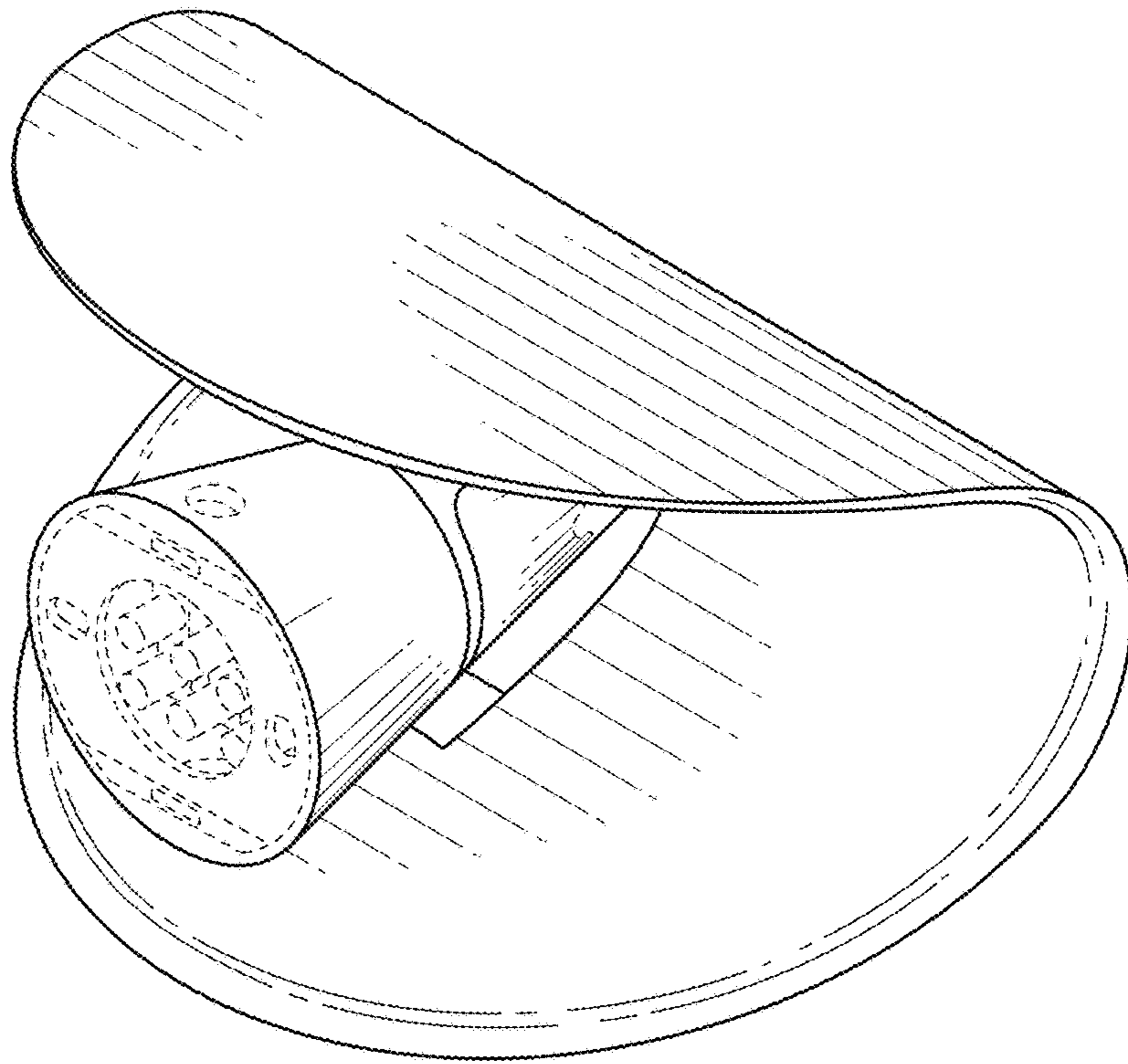

FIG. 1

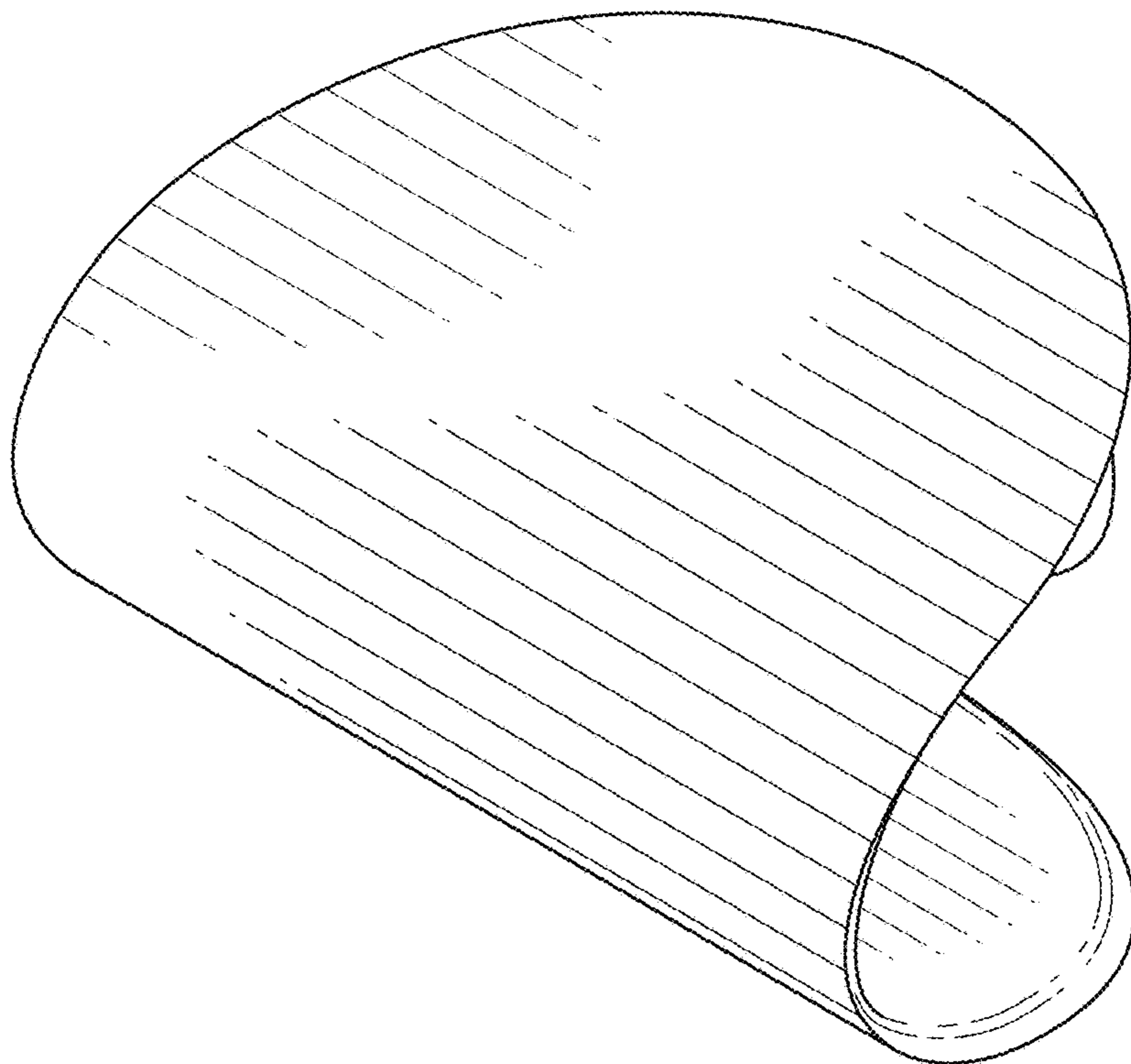

FIG. 2

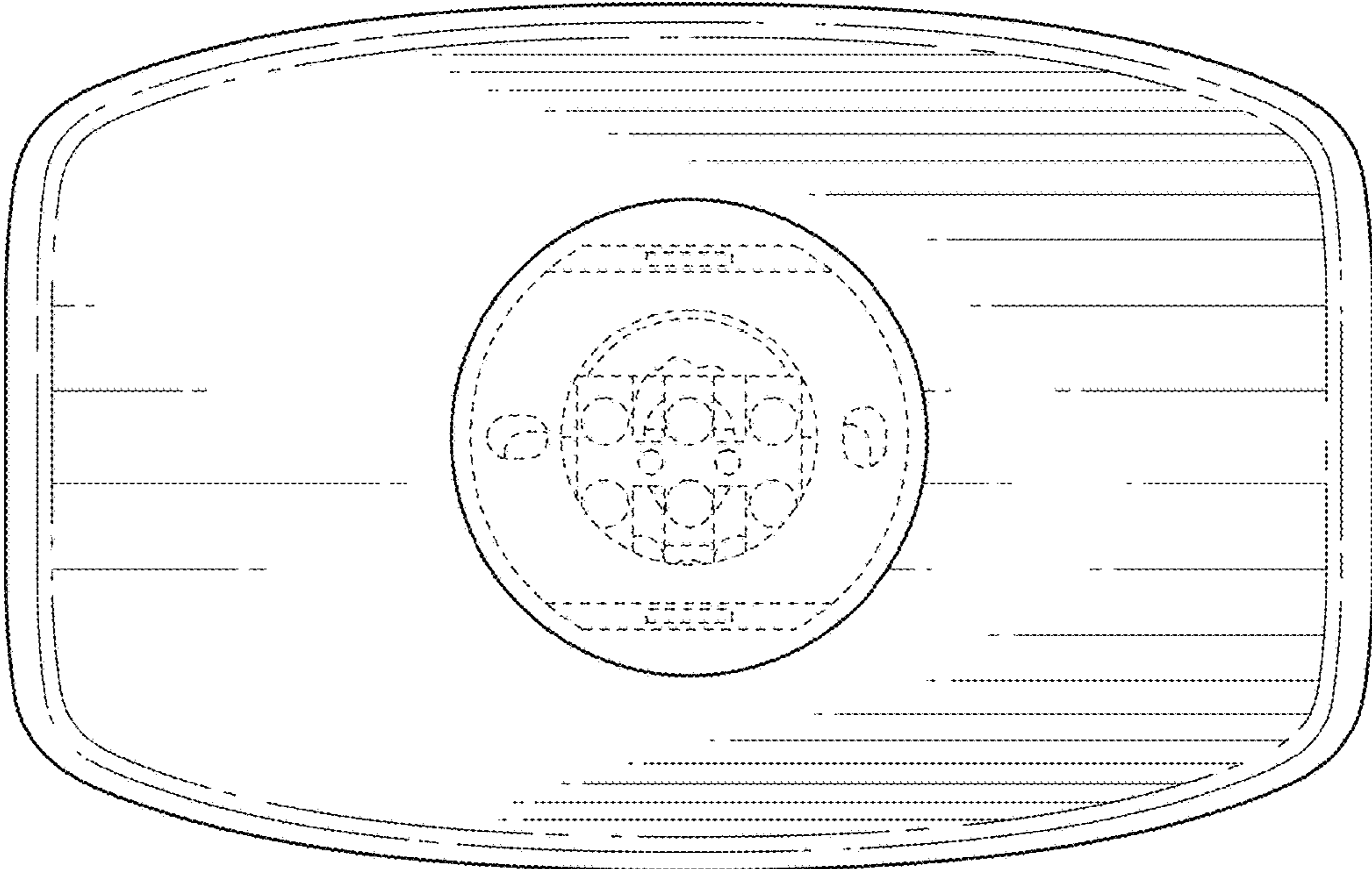

FIG. 3

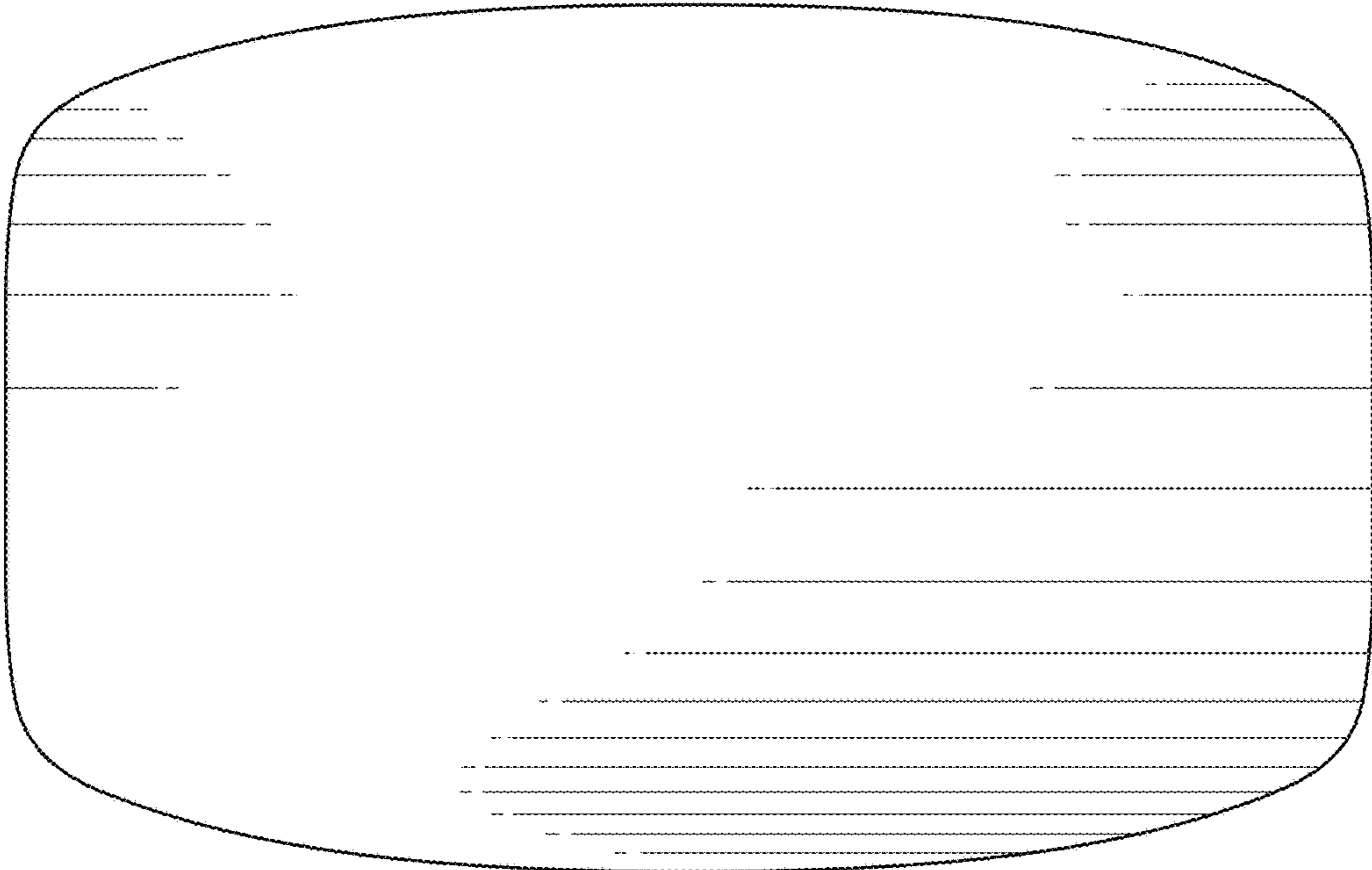

FIG. 4

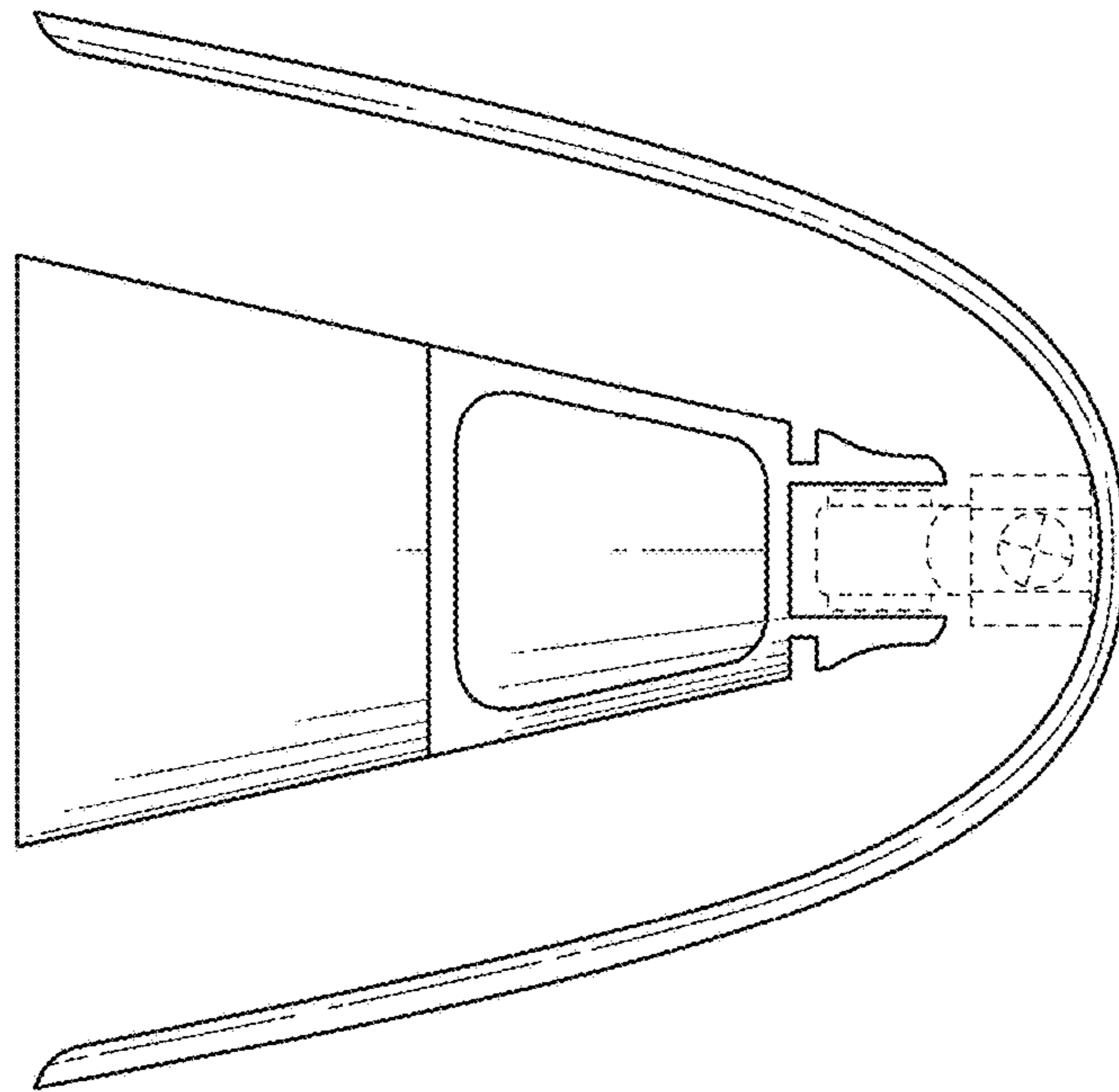

FIG. 5

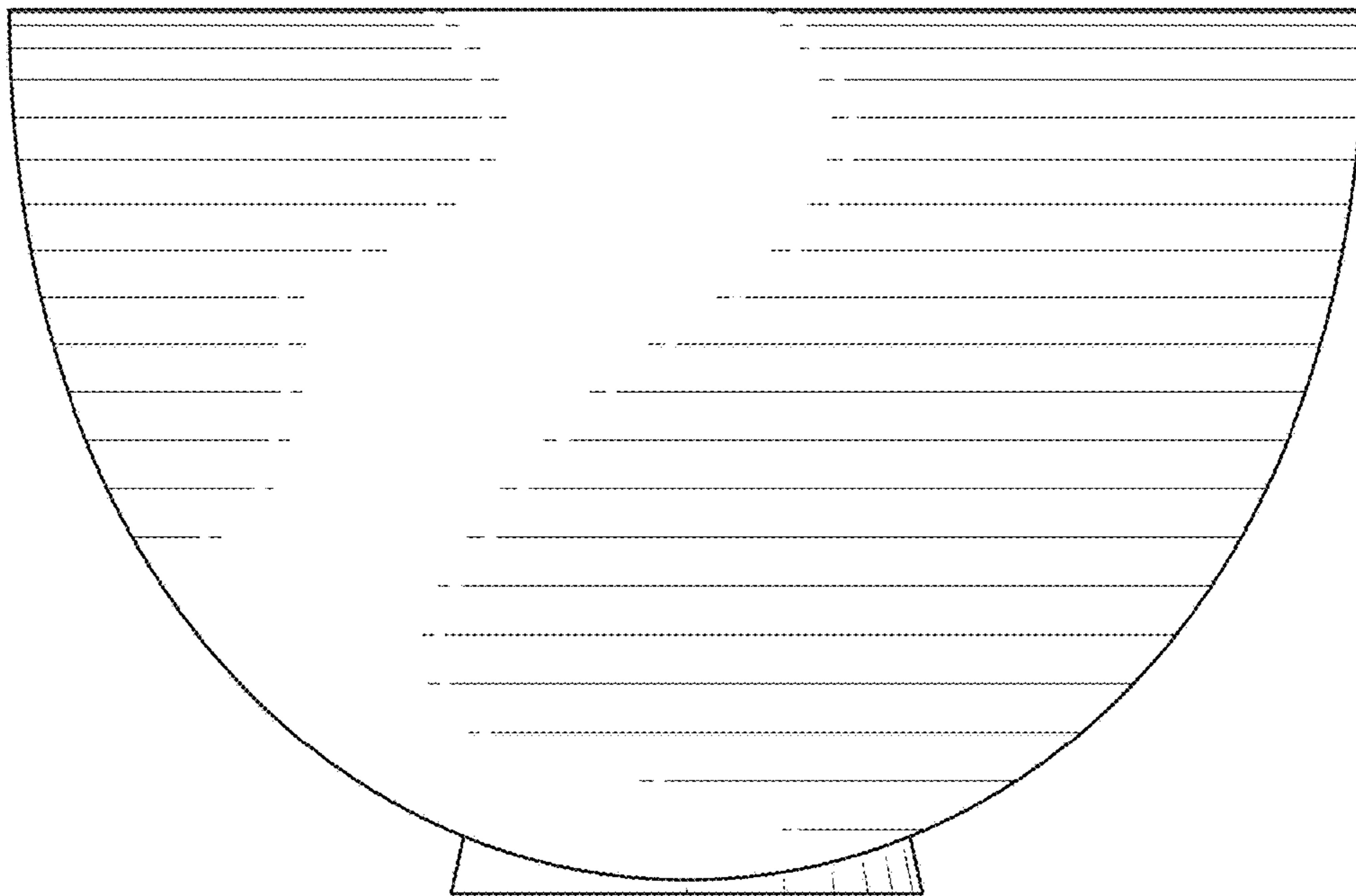

FIG. 6

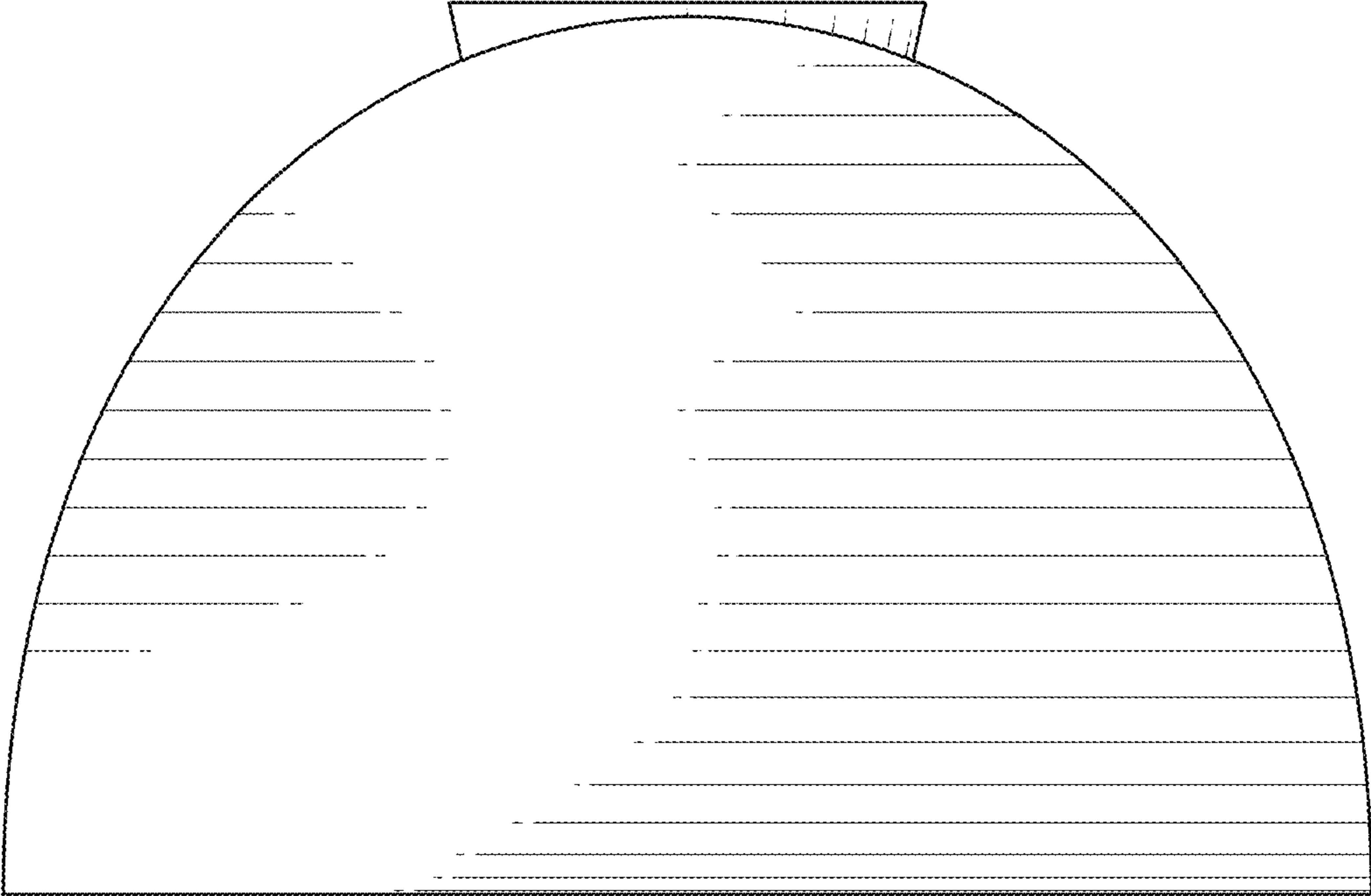

FIG. 7