



US00D823410S

(12) **United States Design Patent** (10) **Patent No.:** **US D823,410 S**
Parsons et al. (45) **Date of Patent:** **** Jul. 17, 2018**

(54) **GOLF CLUB HEAD** 1,538,312 A * 5/1925 Beat A63B 53/08
 473/335
 (71) Applicant: **PARSONS XTREME GOLF, LLC,** 1,543,691 A * 6/1925 Beat A63B 53/08
 Scottsdale, AZ (US) 473/342
 1,774,590 A * 9/1930 Buhcke A63B 53/04
 473/328
 (72) Inventors: **Robert R. Parsons,** Scottsdale, AZ 1,910,055 A * 5/1933 Reach A63B 53/04
 (US); **Bradley D. Schweigert,** Anthem, 473/344
 AZ (US); **Michael R. Nicolette,**
 Scottsdale, AZ (US) D94,549 S * 2/1935 Jansky D21/752
 D94,550 S * 2/1935 Jansky D21/752
 D138,437 S * 8/1944 Link D21/752
 (73) Assignee: **PARSONS XTREME GOLF, LLC,** D138,438 S * 8/1944 Link D21/752
 Scottsdale, AZ (US) D138,439 S * 8/1944 Link D21/752
 D138,441 S * 8/1944 Link D21/752
 D138,442 S * 8/1944 Link D21/752
 (**) Term: **15 Years** D185,177 S * 5/1959 Smith D21/752
 3,652,094 A 3/1972 Glover
 (21) Appl. No.: **29/600,313** D229,431 S * 11/1973 Baker 473/314
 D234,609 S * 3/1975 Raymont D21/752
 (22) Filed: **Apr. 11, 2017** D234,610 S * 3/1975 Raymont D21/752
 D240,748 S 7/1976 Bock
 4,085,934 A 4/1978 Churchward
 D253,778 S 12/1979 Madison
 D307,783 S 5/1990 Linuma
 D326,885 S 6/1992 Paul
 D351,883 S 10/1994 Solheim et al.
 5,518,243 A * 5/1996 Redman A63B 53/04
 473/334
 D378,111 S * 2/1997 Parente D21/752
 D384,120 S * 9/1997 De La Cruz D21/752
 5,788,584 A 8/1998 Parente et al.
 D400,625 S 11/1998 Kubica et al.
 D400,627 S 11/1998 Kubica et al.
 D405,489 S 2/1999 Kubica et al.
 D405,492 S 2/1999 Kubica et al.
 5,997,415 A 12/1999 Wood
 D444,830 S 7/2001 Kubica et al.
 6,290,609 B1 9/2001 Takeda
 6,306,048 B1 10/2001 McCabe et al.
 6,409,612 B1 6/2002 Evans et al.
 D478,140 S 8/2003 Burrows
 6,638,182 B2 10/2003 Kosmatka
 6,773,360 B2 8/2004 Willett et al.
 D508,969 S 8/2005 Hasebe
 D513,051 S 12/2005 Barez et al.
 D514,179 S 1/2006 Chen et al.
 D514,185 S 1/2006 Barez et al.
 D520,586 S 5/2006 Bingman
 D522,077 S 5/2006 Schweigert et al.
 D522,601 S 6/2006 Schweigert et al.
 D523,498 S 6/2006 Chen et al.
 D526,694 S 8/2006 Schweigert et al.
 7,083,530 B2 8/2006 Wahl et al.

Related U.S. Application Data

(63) Continuation-in-part of application No. 29/548,537,
 filed on Dec. 15, 2015, now Pat. No. Des. 786,377,
 which is a continuation-in-part of application No.
 29/543,195, filed on Oct. 21, 2015.
 (51) **LOC (11) Cl.** **21-02**
 (52) **U.S. Cl.**
 USPC **D21/759**
 (58) **Field of Classification Search**
 USPC D21/733, 752, 759
 CPC A63B 53/00; A63B 53/04; A63B 53/0466;
 A63B 2053/002; A63B 2053/0445; A63B
 2053/0433; A63B 2053/0437; A63B
 2053/0491
 See application file for complete search history.

(56) **References Cited**

U.S. PATENT DOCUMENTS

1,133,129 A 3/1915 Govan
 1,269,745 A 6/1918 Robertson
 1,306,029 A 6/1919 Robertson
 D55,867 S 7/1920 Mattern
 1,534,600 A * 4/1925 Mattern A63B 53/08
 473/337

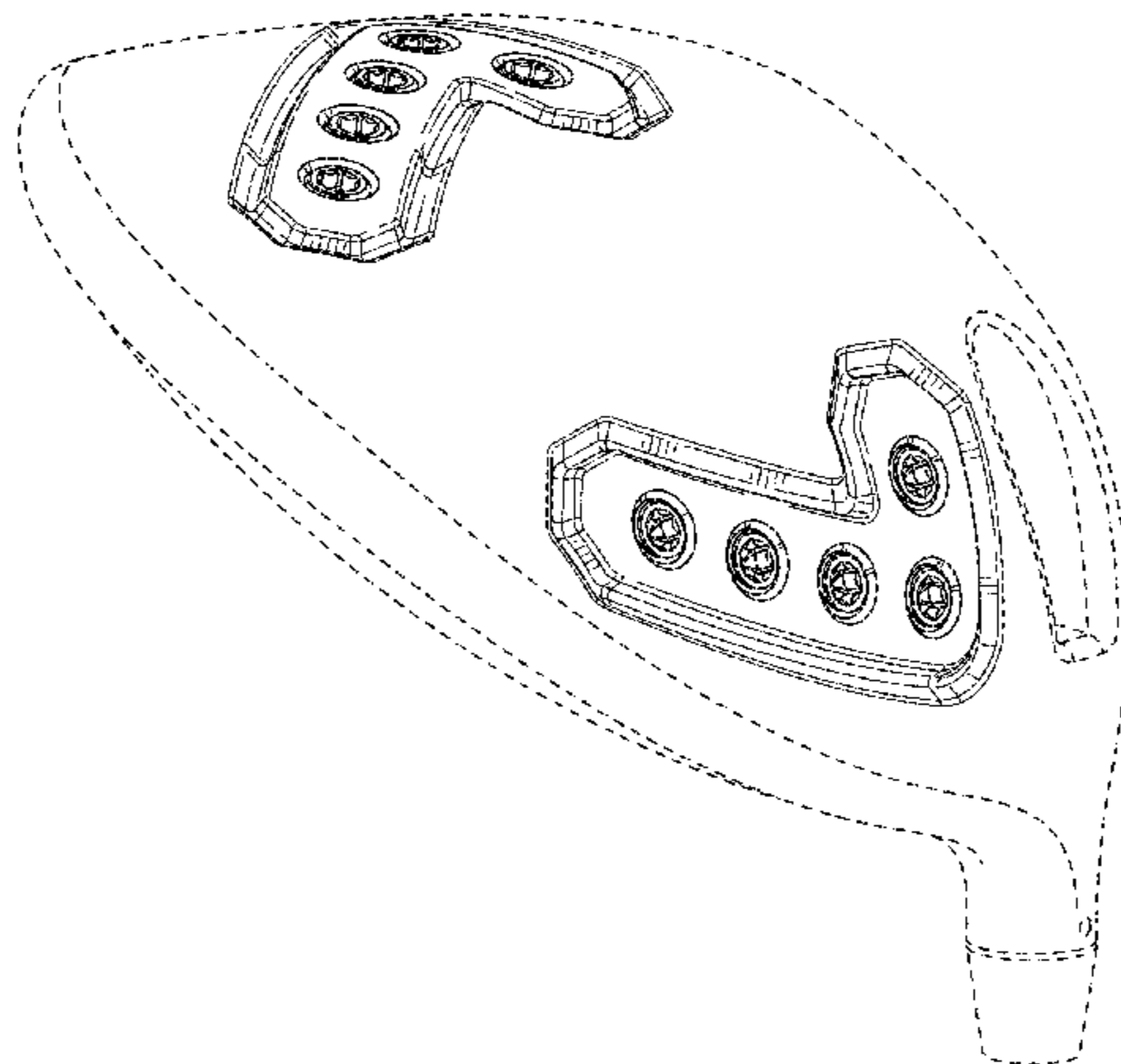

US D823,410 S

7,121,956 B2	10/2006	Lo	D709,153 S *	7/2014	Fossum	D21/759
D534,599 S	1/2007	Barez et al.	8,777,778 B2	7/2014	Solheim et al.	
7,166,040 B2	1/2007	Hoffman et al.	8,784,232 B2	7/2014	Jertson et al.	
D536,401 S	2/2007	Kawami	8,790,196 B2	7/2014	Solheim et al.	
D536,403 S	2/2007	Kawami	8,808,108 B2	8/2014	Schweigert	
7,186,190 B1	3/2007	Beach et al.	D712,989 S	9/2014	Gillig	
7,223,180 B2	5/2007	Willett et al.	8,826,512 B2	9/2014	Schweigert	
D563,498 S	3/2008	Jertson et al.	8,858,362 B1	10/2014	Leposky et al.	
D564,054 S	3/2008	Jertson et al.	8,961,336 B1	2/2015	Parsons et al.	
D564,055 S	3/2008	Jertson et al.	D724,164 S *	3/2015	Schweigert	D21/752
7,338,388 B2	3/2008	Schweigert et al.	8,979,671 B1	3/2015	DeMille et al.	
7,347,794 B2	3/2008	Schweigert	D729,892 S *	5/2015	Nicolette	D21/752
D567,317 S	4/2008	Jertson et al.	D733,234 S *	6/2015	Nicolette	D21/752
D566,934 S	5/2008	Jertson et al.	9,199,140 B1 *	12/2015	Schweigert	A63B 53/0466
D569,933 S	5/2008	Jertson et al.	9,199,143 B1	12/2015	Parsons et al.	
D569,935 S	5/2008	Jertson et al.	D746,927 S *	1/2016	Parsons	D21/752
D569,936 S	5/2008	Jertson et al.	D750,186 S *	2/2016	Schweigert	D21/746
D569,942 S	5/2008	Jertson et al.	D753,251 S	4/2016	Schweigert et al.	
D570,937 S	6/2008	Schweigert et al.	D755,319 S *	5/2016	Nicolette	D21/759
D570,938 S	6/2008	Jertson et al.	D756,471 S	5/2016	Nicolette et al.	
7,407,447 B2	8/2008	Beach et al.	9,352,197 B2	5/2016	Parsons et al.	
7,410,425 B2	8/2008	Willett et al.	D760,334 S *	6/2016	Schweigert	D21/759
7,410,426 B2	8/2008	Willett et al.	9,399,352 B2	7/2016	Parsons et al.	
7,419,441 B2	9/2008	Hoffman et al.	D764,614 S *	8/2016	Parsons	D21/759
7,448,963 B2	11/2008	Beach et al.	9,427,634 B2	8/2016	Parsons et al.	
7,448,964 B2	11/2008	Schweigert et al.	D767,696 S *	9/2016	Parsons	D21/752
7,530,904 B2	5/2009	Beach et al.	D776,216 S *	1/2017	Schweigert	D21/752
D594,520 S	6/2009	Schweigert et al.	D777,858 S *	1/2017	Schweigert	D21/752
D594,521 S	6/2009	Jertson et al.	D786,377 S *	5/2017	Parsons	D21/752
D594,919 S	6/2009	Schweigert et al.	D795,978 S *	8/2017	Parsons	D21/759
7,540,811 B2	6/2009	Beach et al.	2003/0104878 A1	6/2003	Yabu	
D597,620 S	8/2009	Taylor et al.	2004/0033846 A1	2/2004	Caldwell	
7,568,985 B2	8/2009	Beach et al.	2006/0105856 A1	5/2006	Lo	
7,578,753 B2	8/2009	Beach et al.	2006/0111200 A1	5/2006	Poynor	
D600,297 S	9/2009	Jertson et al.	2007/0004527 A1	1/2007	Helmstetter	
7,584,531 B2	9/2009	Schweigert et al.	2007/0293344 A1	12/2007	Davis	
7,588,502 B2	9/2009	Nishino	2008/0004133 A1	1/2008	Schweigert	
7,591,738 B2	9/2009	Beach et al.	2008/0015049 A1	1/2008	Imamoto	
D603,472 S	11/2009	Schweigert et al.	2008/0188322 A1	8/2008	Anderson et al.	
7,611,424 B2	11/2009	Nagai et al.	2009/0029795 A1	1/2009	Schweigert et al.	
7,621,823 B2	11/2009	Beach et al.	2010/0144461 A1	6/2010	Ban	
D605,715 S	12/2009	Barez et al.	2010/0331102 A1	12/2010	Golden et al.	
7,632,194 B2	12/2009	Beach et al.	2011/0143858 A1	6/2011	Peralta et al.	
7,658,686 B2	2/2010	Soracco	2012/0142445 A1	6/2012	Burnett et al.	
7,713,142 B2	5/2010	Hoffmann et al.	2012/0202615 A1	8/2012	Beach et al.	
7,717,804 B2	5/2010	Beach et al.	2012/0220387 A1	8/2012	Beach et al.	
7,717,805 B2	5/2010	Beach et al.	2013/0210542 A1	8/2013	Harbert et al.	
D618,746 S	6/2010	Jertson et al.	2013/0303304 A1	11/2013	Sato	
D618,747 S	6/2010	Schweigert et al.	2013/0318772 A1	12/2013	Wahl et al.	
D618,753 S	6/2010	Jertson et al.	2014/0235369 A1	8/2014	Willett et al.	
D618,754 S	6/2010	Schweigert et al.	2015/0231454 A1	8/2015	Parsons et al.	
7,744,484 B1	6/2010	Chao	2015/0360098 A1	12/2015	Parsons et al.	
7,798,203 B2	9/2010	Schweigert et al.				
7,846,041 B2	12/2010	Beach et al.				
D635,626 S	4/2011	Nicolette				
7,927,229 B2	4/2011	Jertson et al.				
D638,893 S	5/2011	Schweigert et al.				
D638,896 S *	5/2011	Schweigert				D21/759
7,963,861 B2	6/2011	Beach et al.				
8,012,038 B1	9/2011	Beach et al.				
D647,585 S *	10/2011	Jertson				D21/759
D661,751 S	6/2012	Nicolette et al.				
D661,756 S	6/2012	Nicolette et al.				
8,257,196 B1	9/2012	Abbott et al.				
8,257,197 B2	9/2012	Schweigert				
8,262,506 B2	9/2012	Watson et al.				
D673,630 S	1/2013	Schweigert				
D673,632 S	1/2013	Schweigert et al.				
8,371,957 B2	2/2013	Schweigert et al.				
D680,179 S	4/2013	Solheim et al.				
8,414,422 B2	4/2013	Peralta et al.				
8,485,919 B2	7/2013	Rice et al.				
D691,230 S *	10/2013	Chen				D21/759
8,562,457 B2	10/2013	Beach et al.				
8,608,587 B2	12/2013	Henrikson et al.				
8,628,431 B2	1/2014	Schweigert et al.				
8,651,975 B2	2/2014	Soracco				
8,663,026 B2	3/2014	Blowers et al.				
D705,879 S *	5/2014	Chen				D21/752

* cited by examiner

Primary Examiner — Mitchell I. Siegel

(57)

CLAIM

The ornamental design for a golf club head, as shown and described.

DESCRIPTION

FIG. 1 is a top perspective view of a golf club head;
 FIG. 2 is a bottom perspective view of the golf club head of FIG. 1;
 FIG. 3 is a front elevational view of the golf club head of FIG. 1;
 FIG. 4 is a rear elevational view of the golf club head of FIG. 1;
 FIG. 5 is a top view of the golf club head of FIG. 1;
 FIG. 6 is a bottom view of the golf club head of FIG. 1;
 FIG. 7 is a right side view of the golf club head of FIG. 1;
 FIG. 8 is a left side view of the golf club head of FIG. 1;

FIG. 9 is a top perspective view of a second embodiment of the golf club head;

FIG. 10 is a bottom perspective view of the golf club head of FIG. 9;

FIG. 11 is a front elevational view of the golf club head of FIG. 9;

FIG. 12 is a rear elevational view of the golf club head of FIG. 9;

FIG. 13 is a top view of the golf club head of FIG. 9;

FIG. 14 is a bottom view of the golf club head of FIG. 9;

FIG. 15 is a left side view of the golf club head of FIG. 9;

FIG. 16 is a right side view of the golf club head of FIG. 9;

FIG. 17 is a top perspective view of a third embodiment of the golf club head;

FIG. 18 is a bottom perspective view of the golf club head of FIG. 17;

FIG. 19 is a front elevational view of the golf club head of FIG. 17;

FIG. 20 is a rear elevational view of the golf club head of FIG. 17;

FIG. 21 is a top view of the golf club head of FIG. 17;

FIG. 22 is a bottom view of the golf club head of FIG. 17;

FIG. 23 is a left side view of the golf club head of FIG. 17;

FIG. 24 is a right side view of the golf club head of FIG. 17;

FIG. 25 is a top perspective view of a fourth embodiment of the golf club head;

FIG. 26 is a bottom perspective view of the golf club head of FIG. 25;

FIG. 27 is a front elevational view of the golf club head of FIG. 25;

FIG. 28 is a rear elevational view of the golf club head of FIG. 25;

FIG. 29 is a top view of the golf club head of FIG. 25;

FIG. 30 is a bottom view of the golf club head of FIG. 25;

FIG. 31 is a left side view of the golf club head of FIG. 25;

and,

FIG. 32 is a right side view of the golf club head of FIG. 25.

The broken lines are included for the purpose of illustration only. None of the broken lines forms part of the claimed design.

1 Claim, 32 Drawing Sheets

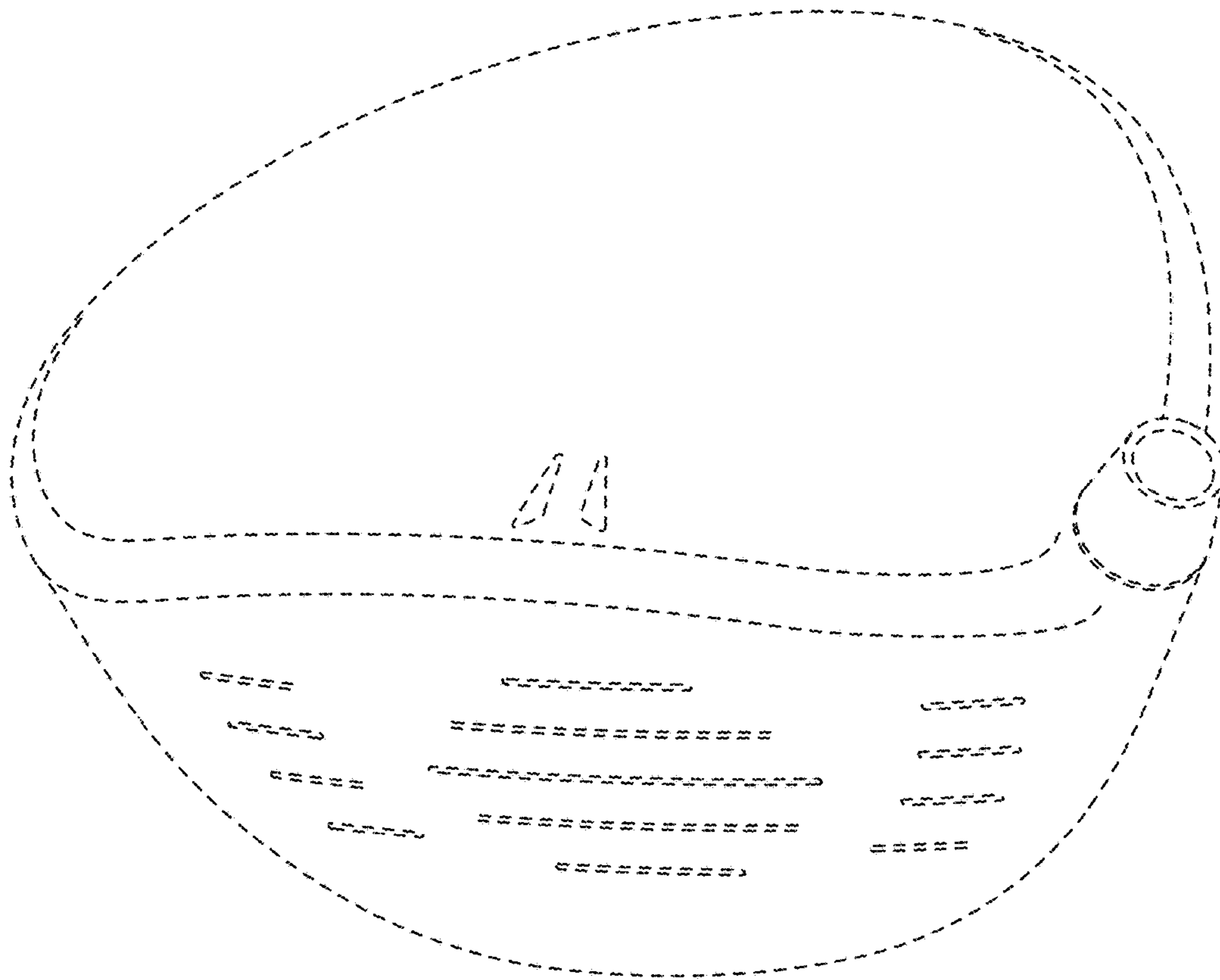

FIG. 1

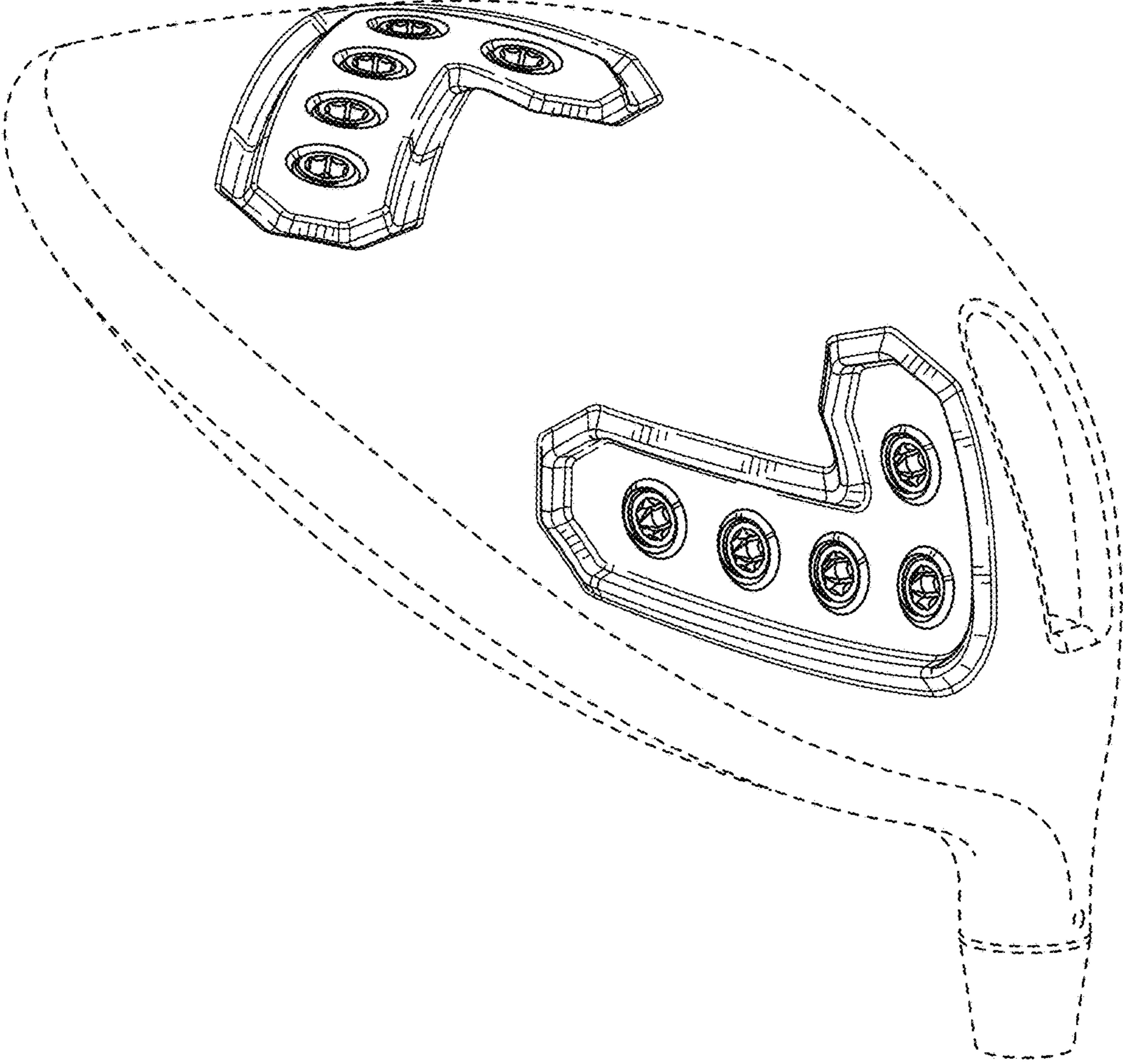

FIG. 2

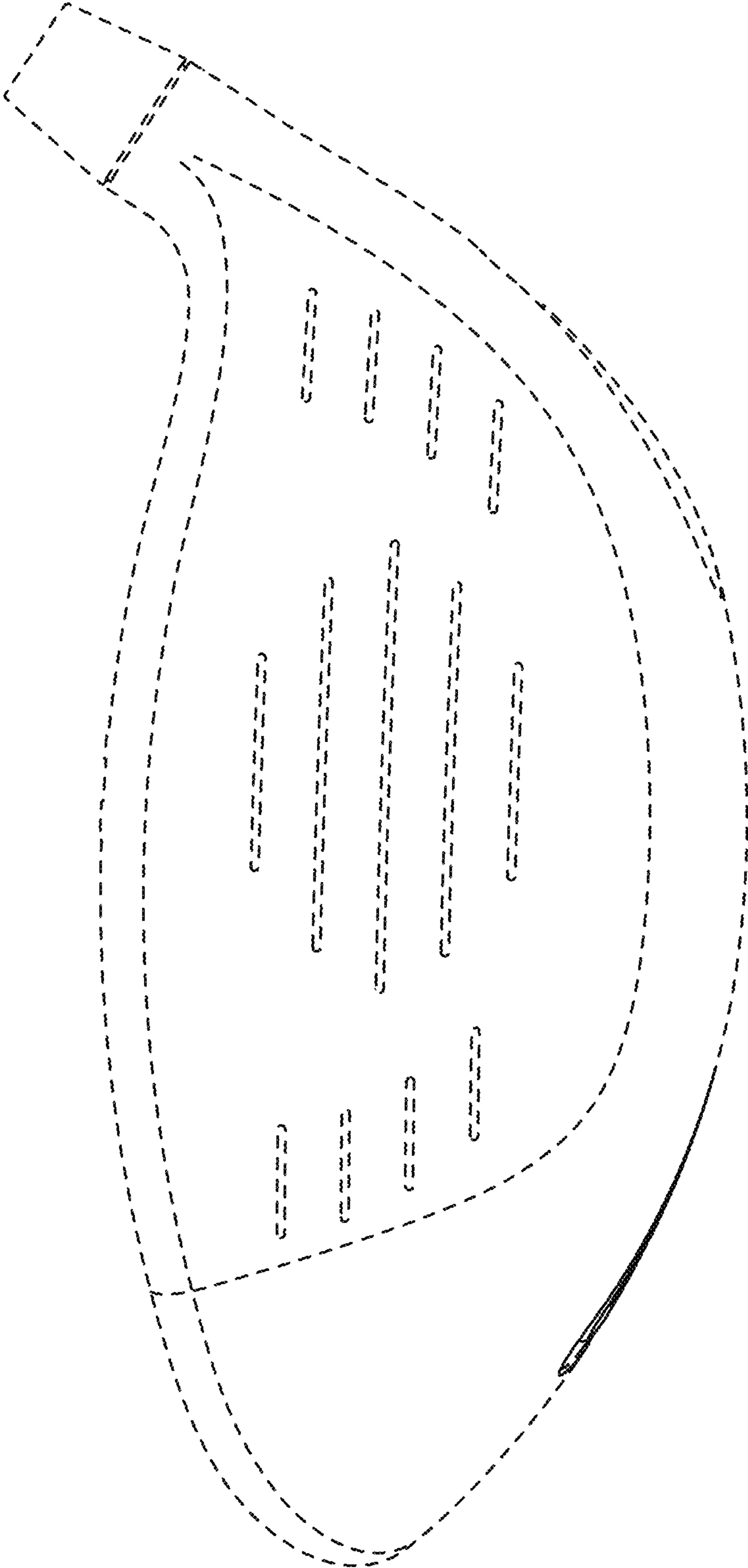

FIG. 3

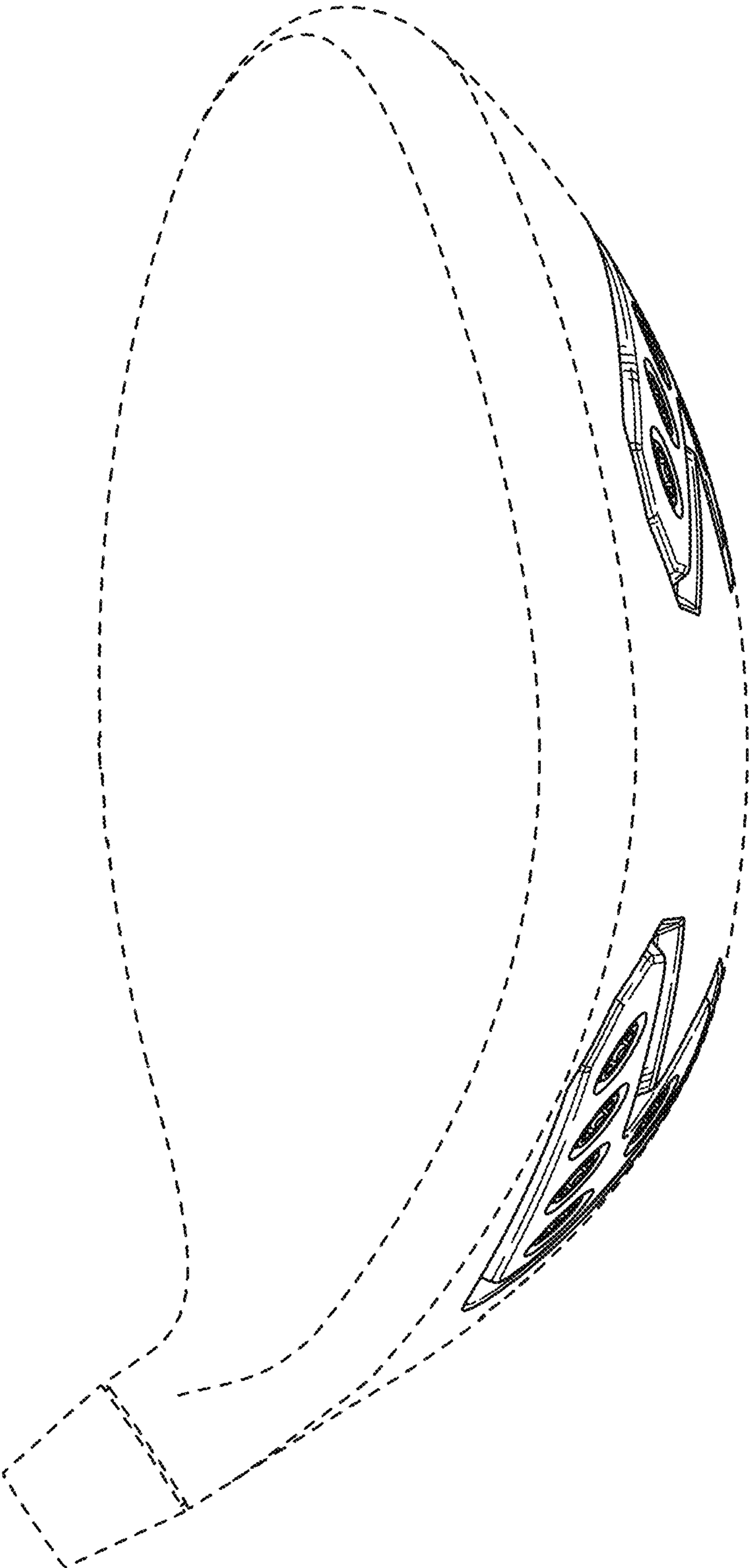

FIG. 4

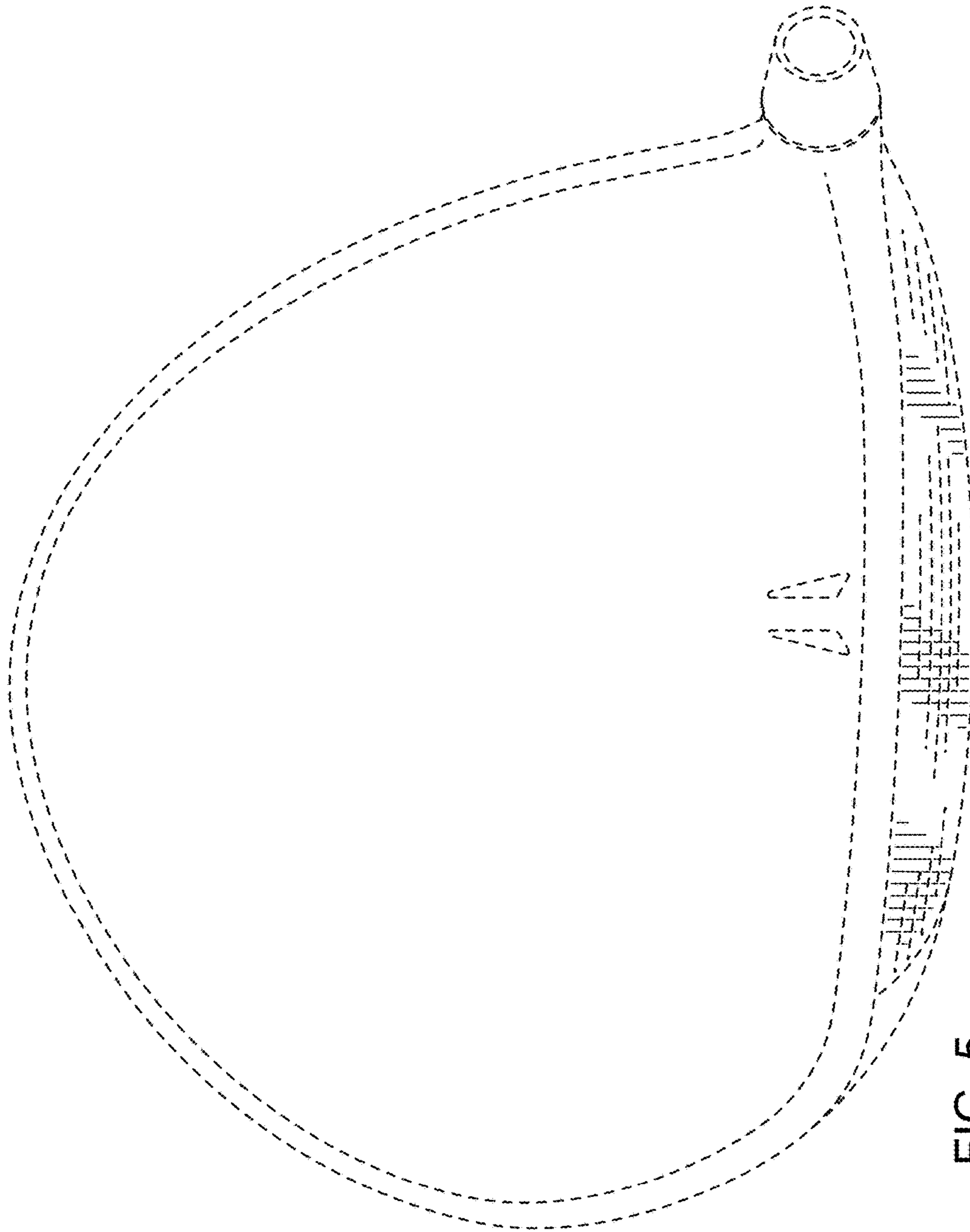

FIG. 5

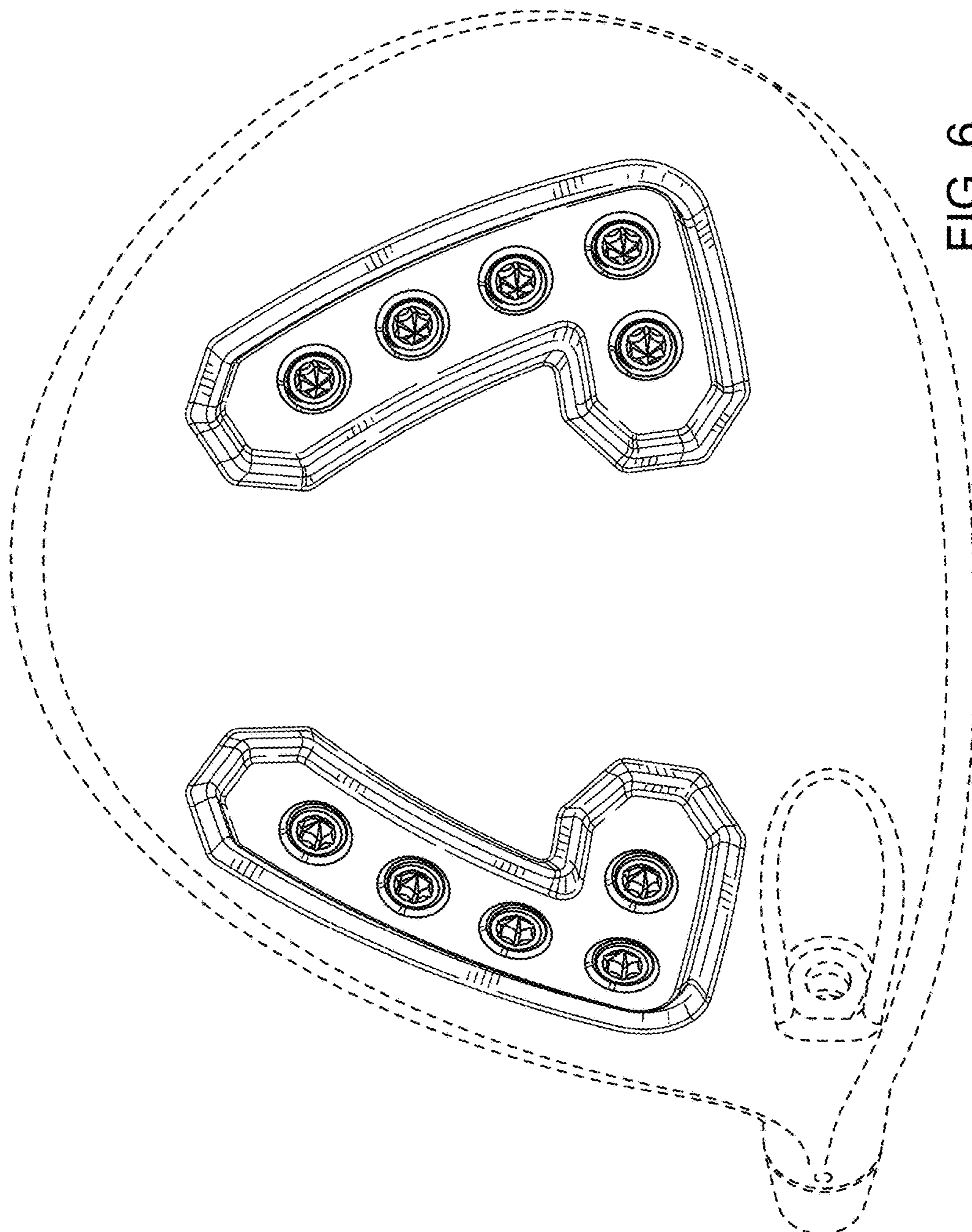

FIG. 6

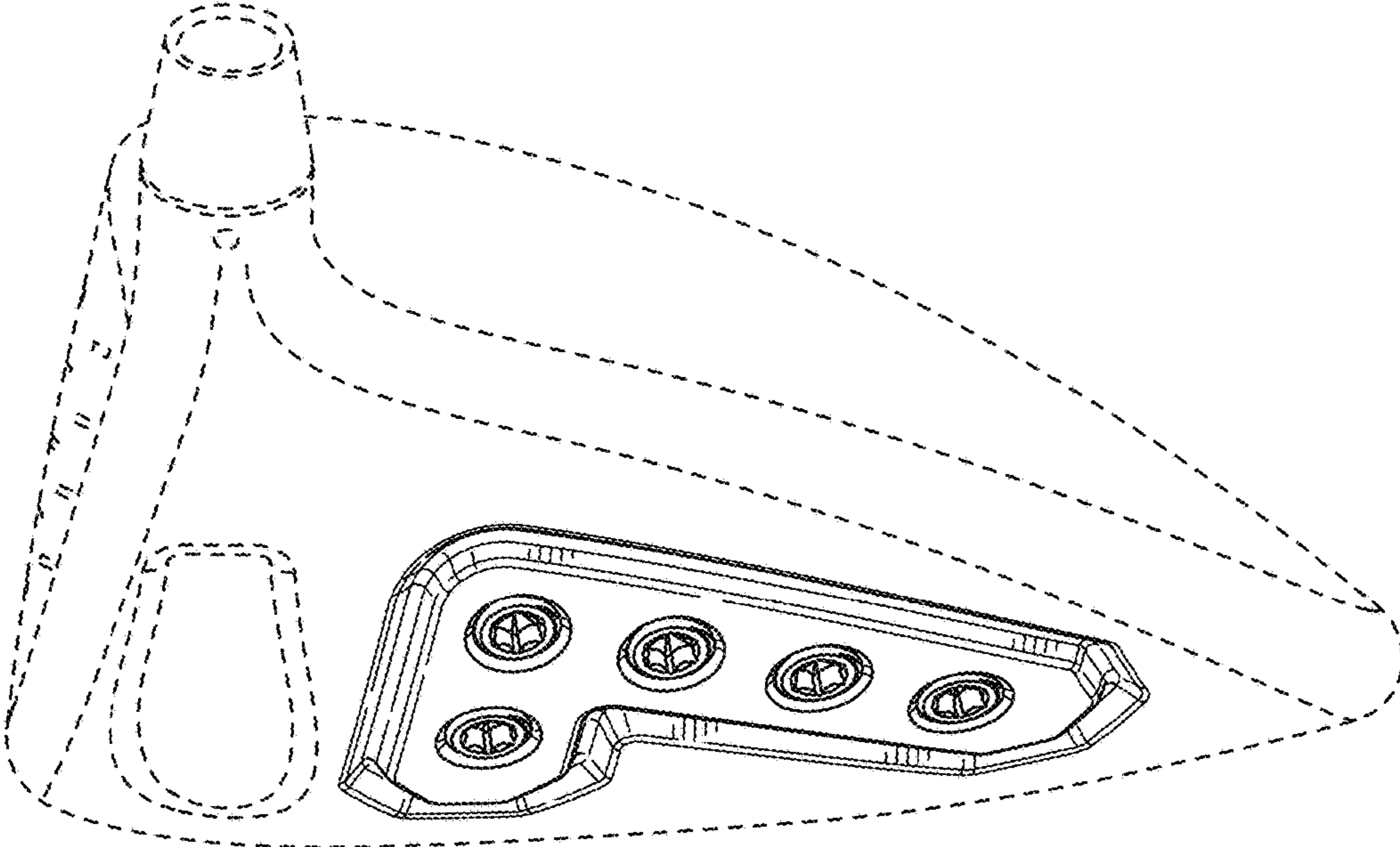

FIG. 7

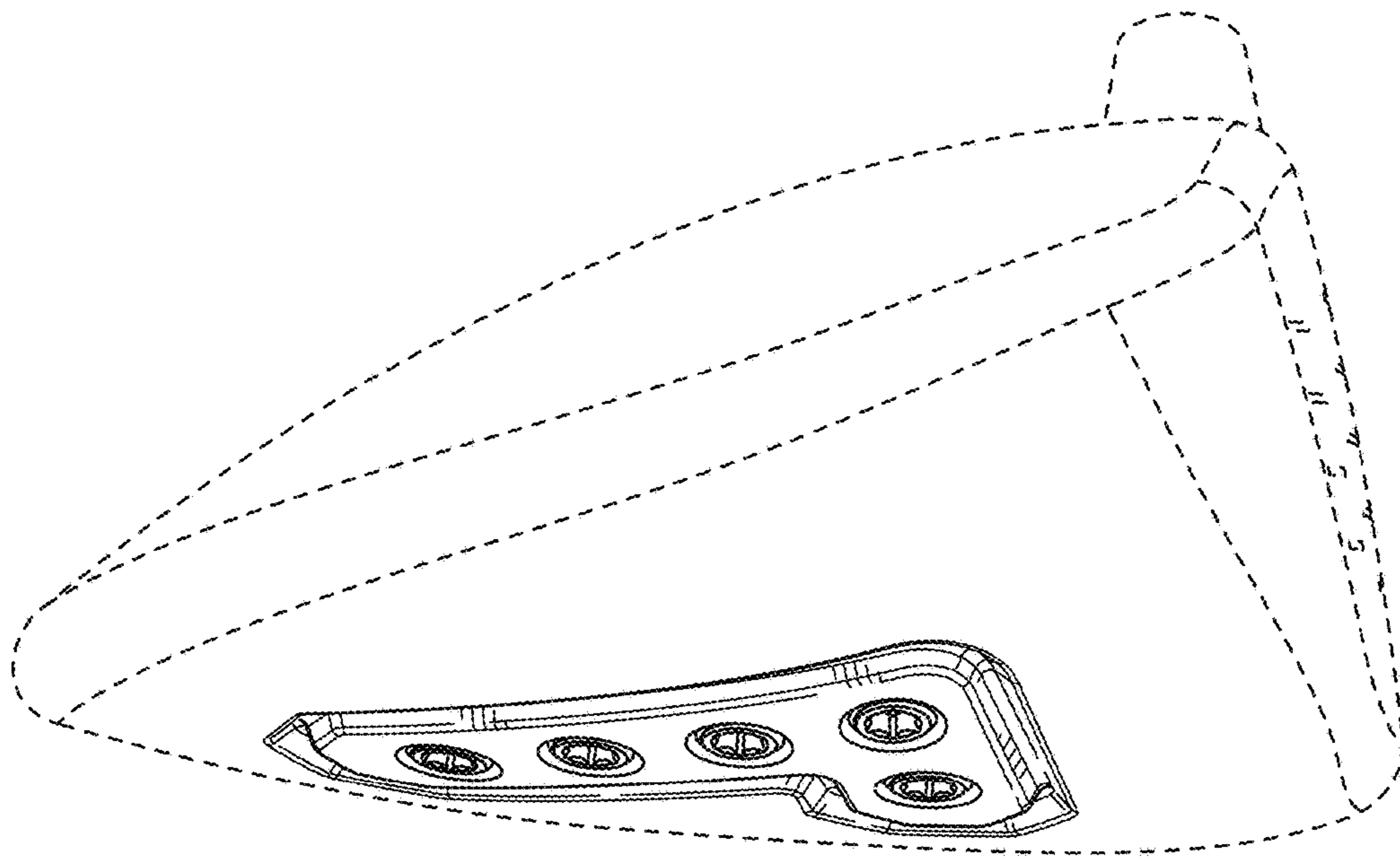

FIG. 8

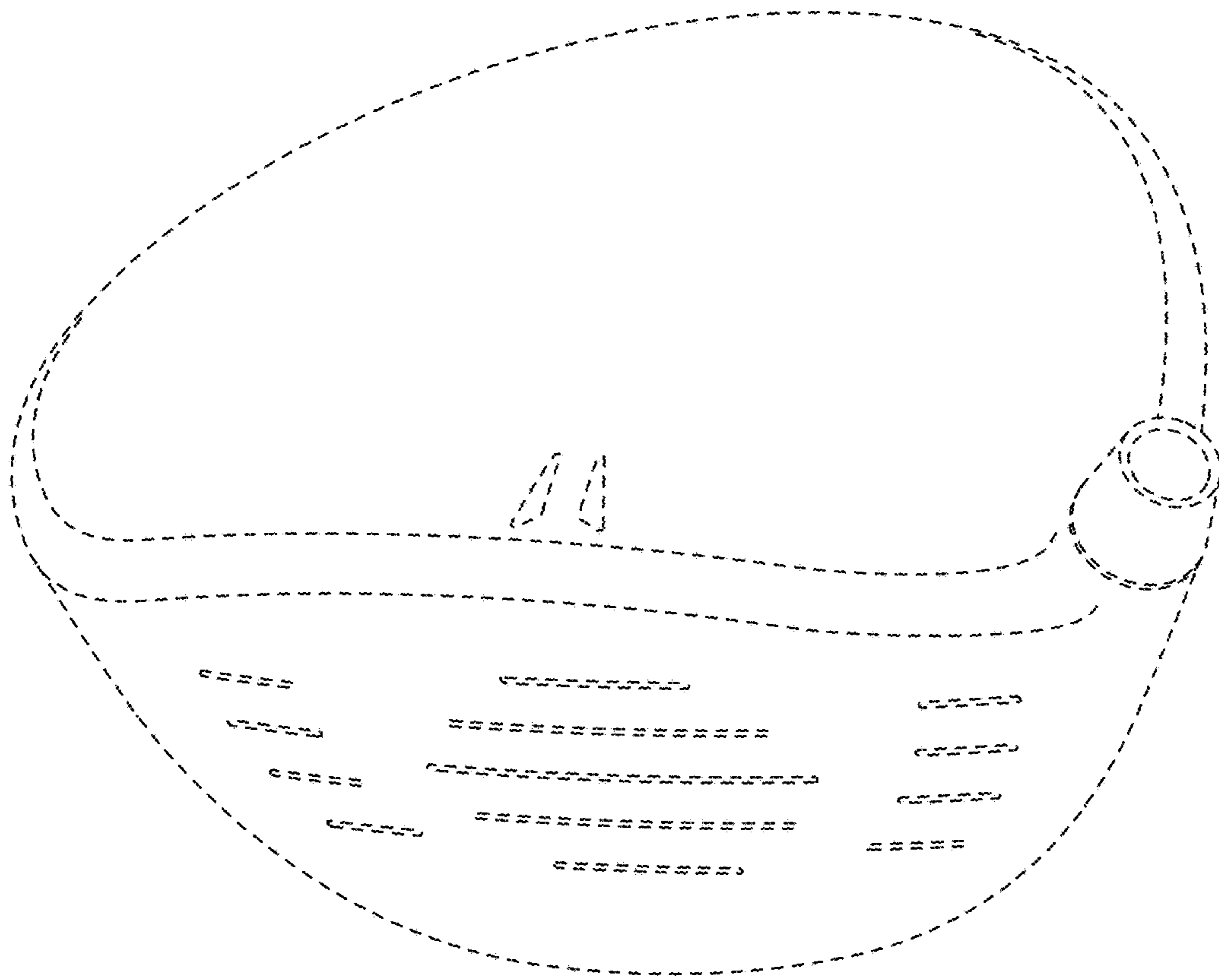

FIG. 9

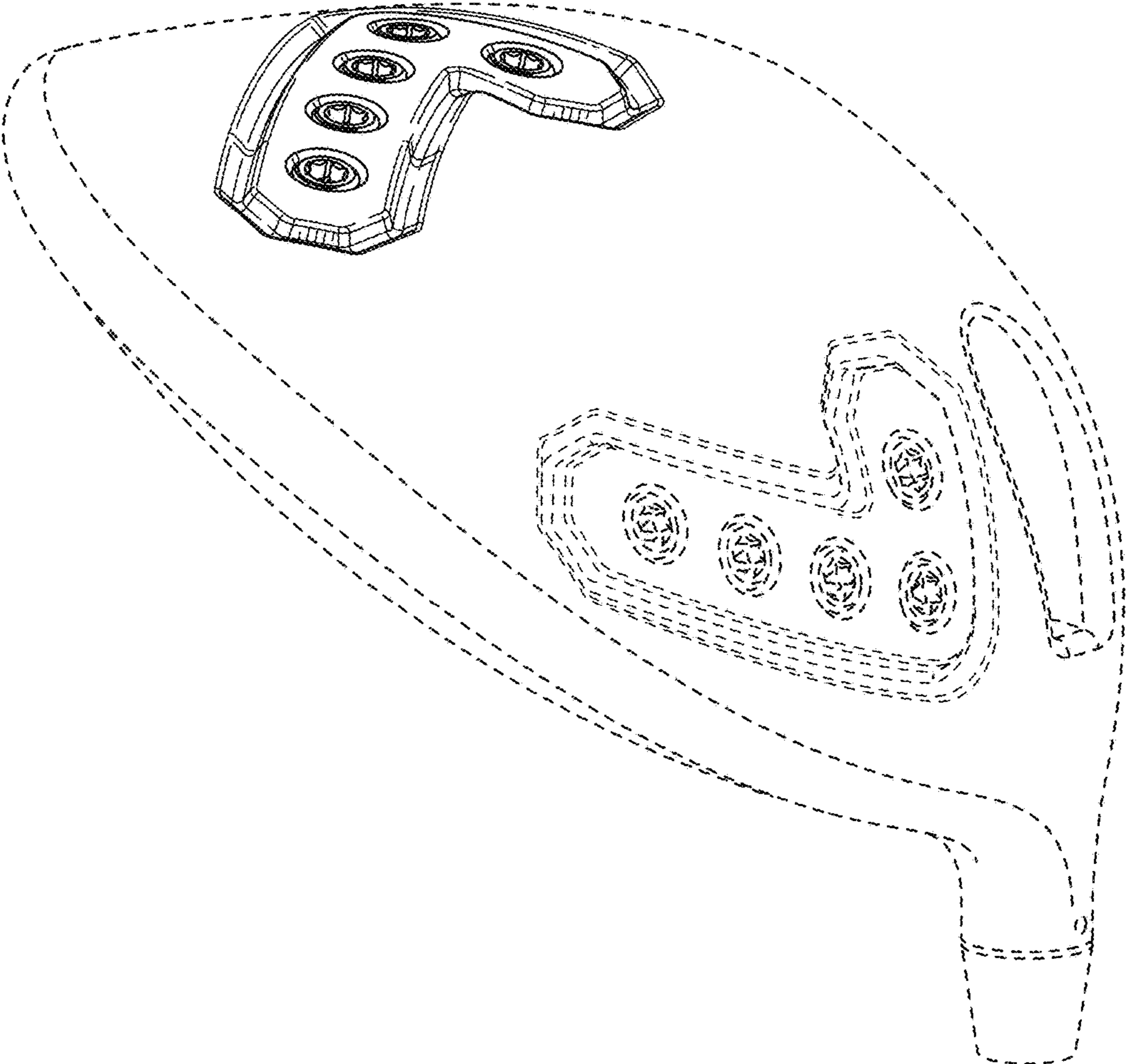

FIG. 10

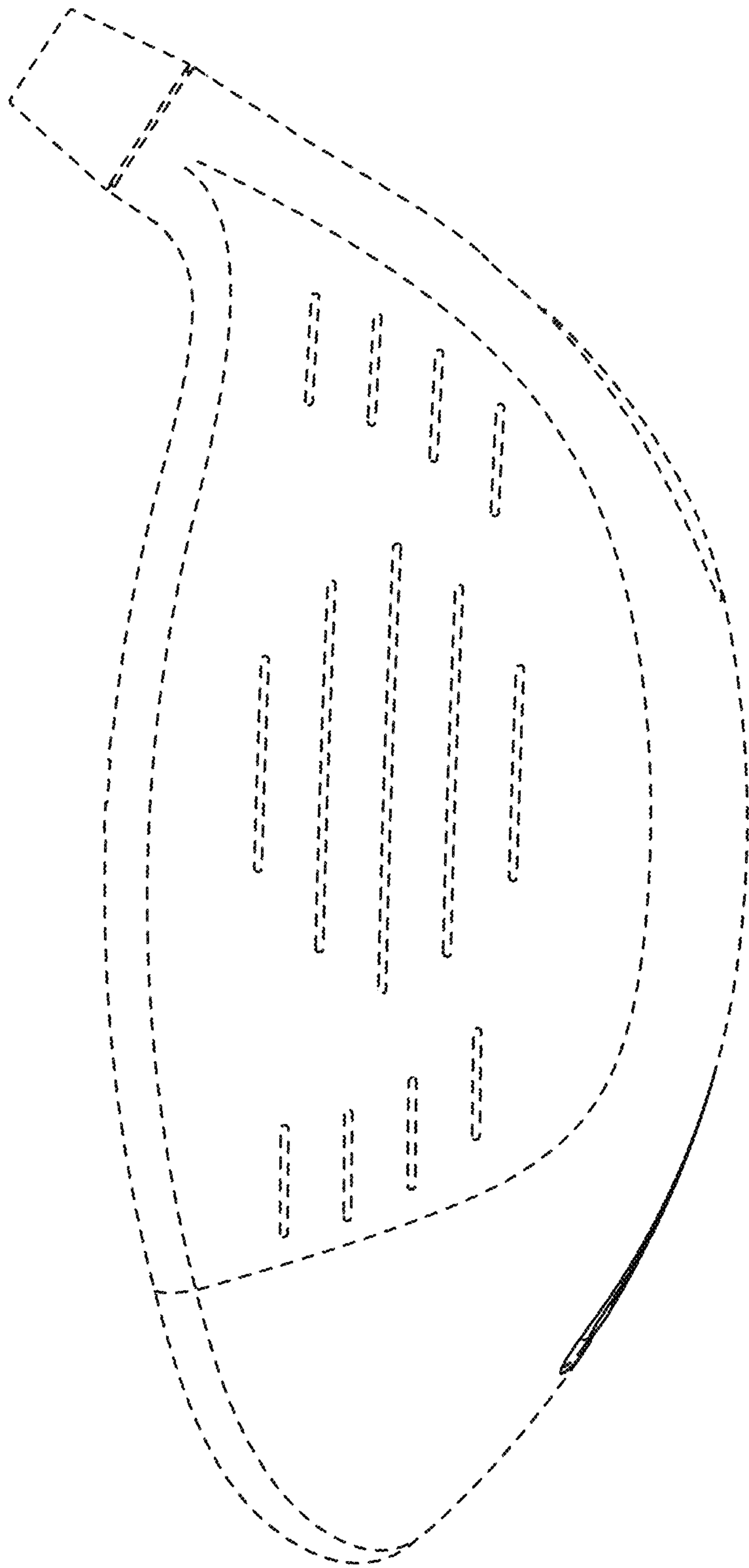

FIG. 11

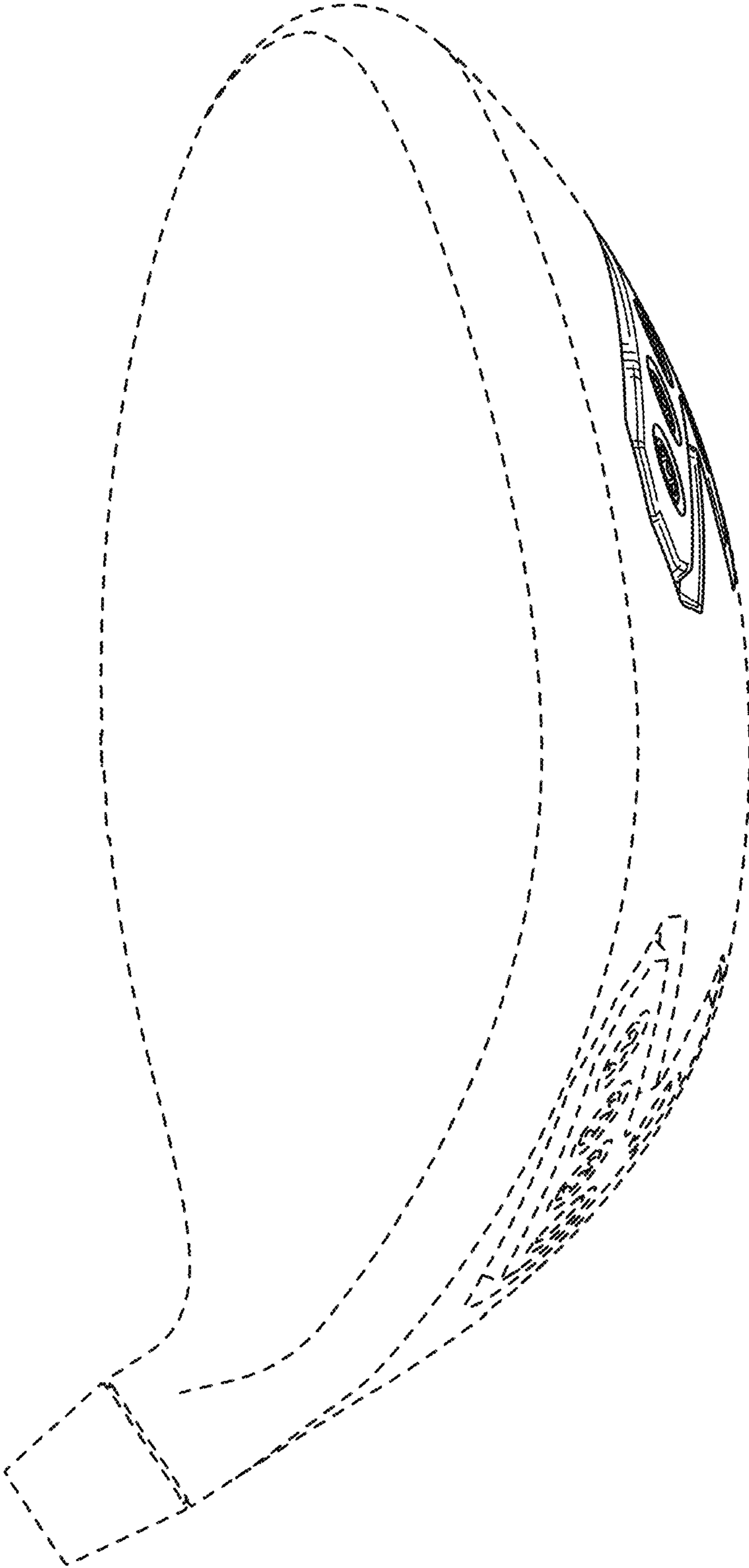

FIG. 12

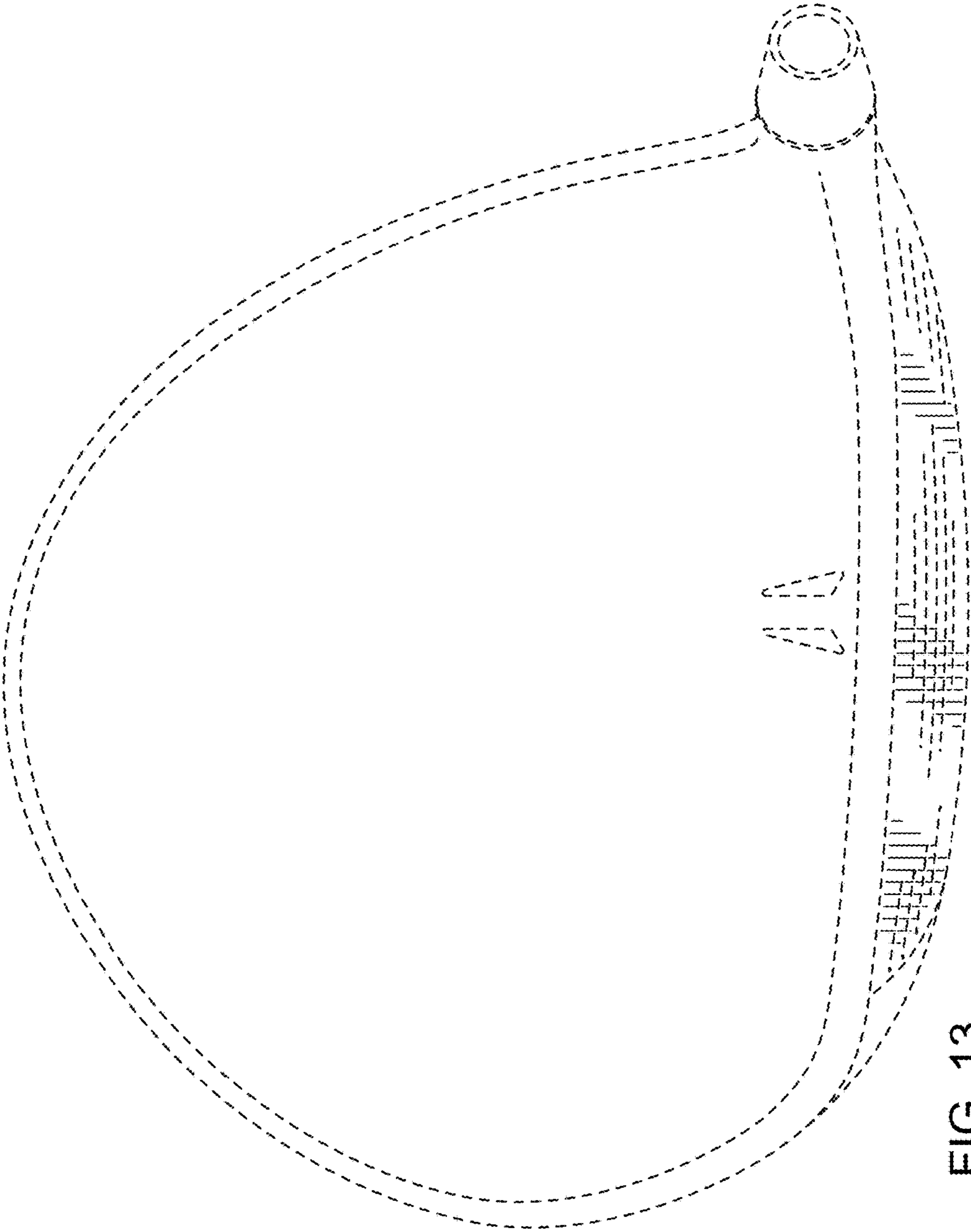

FIG. 13

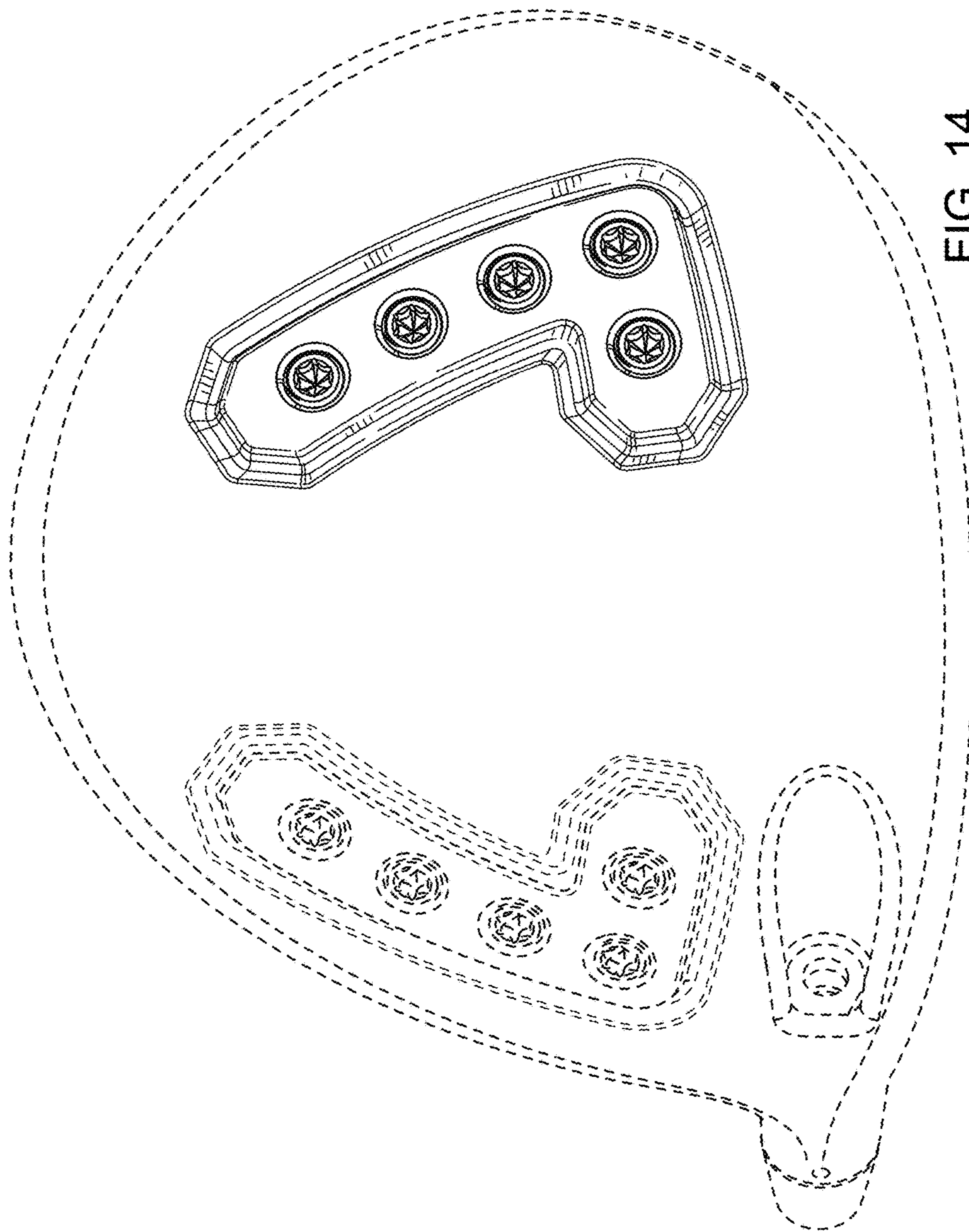

FIG. 14

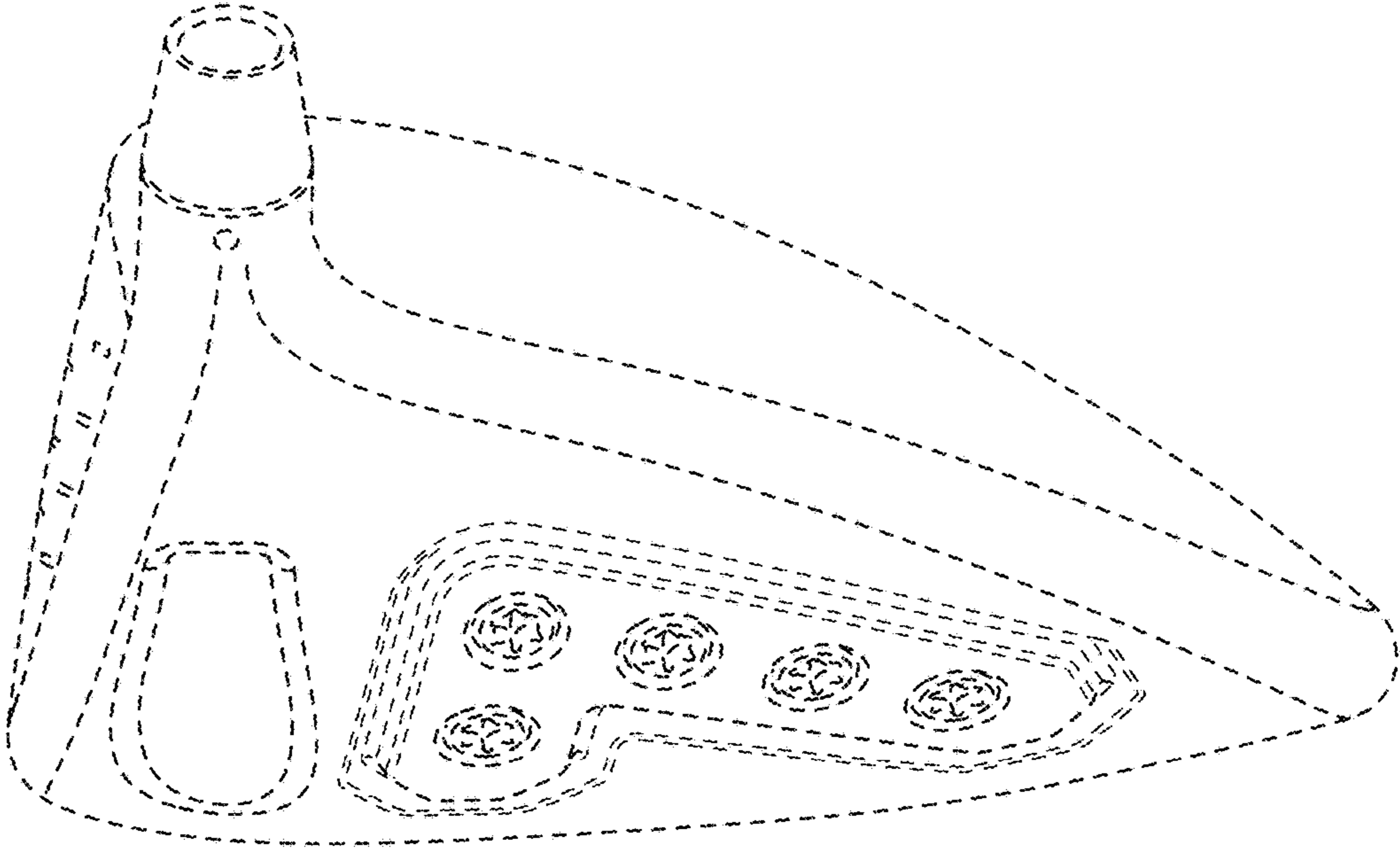

FIG. 15

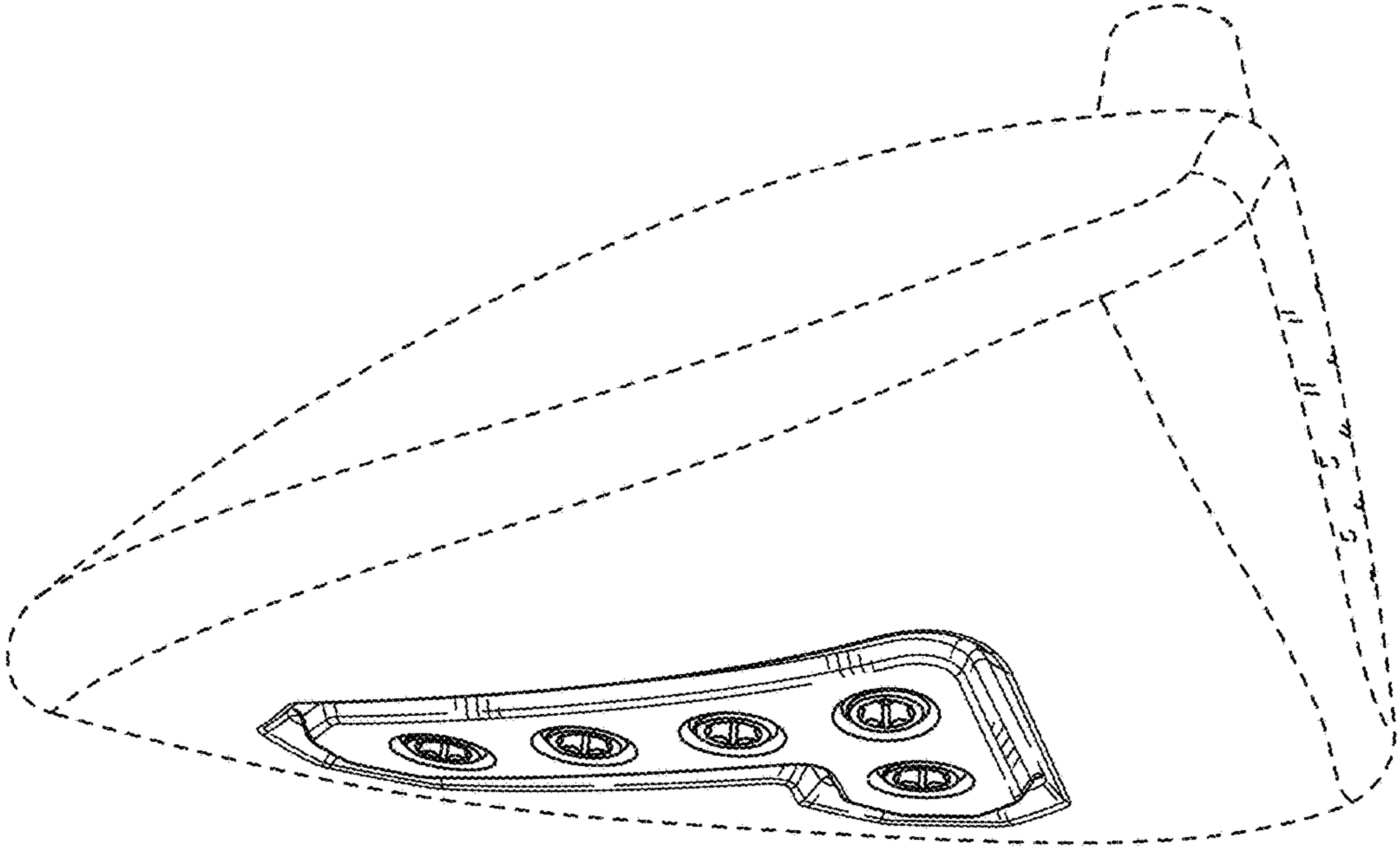

FIG. 16

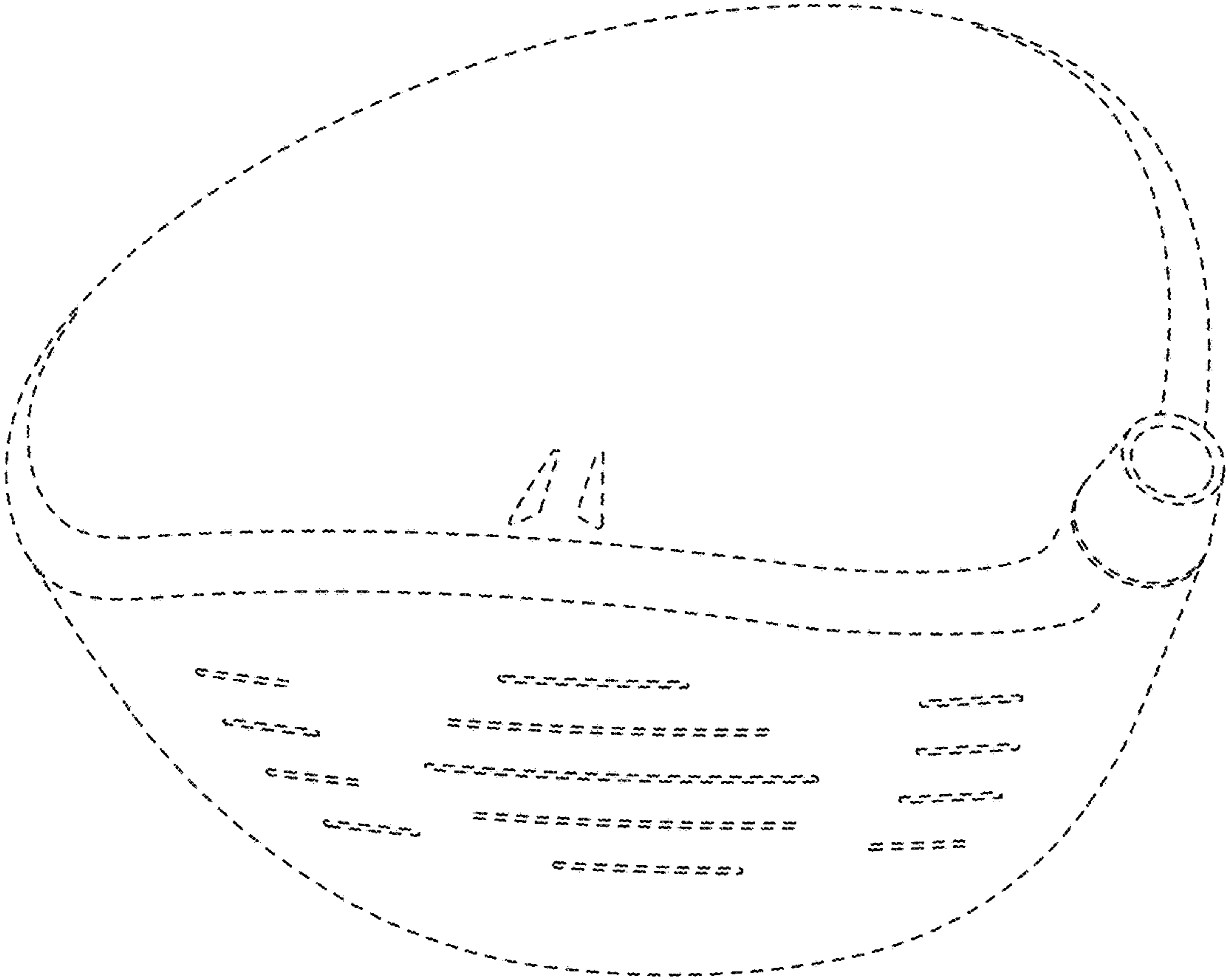

FIG. 17

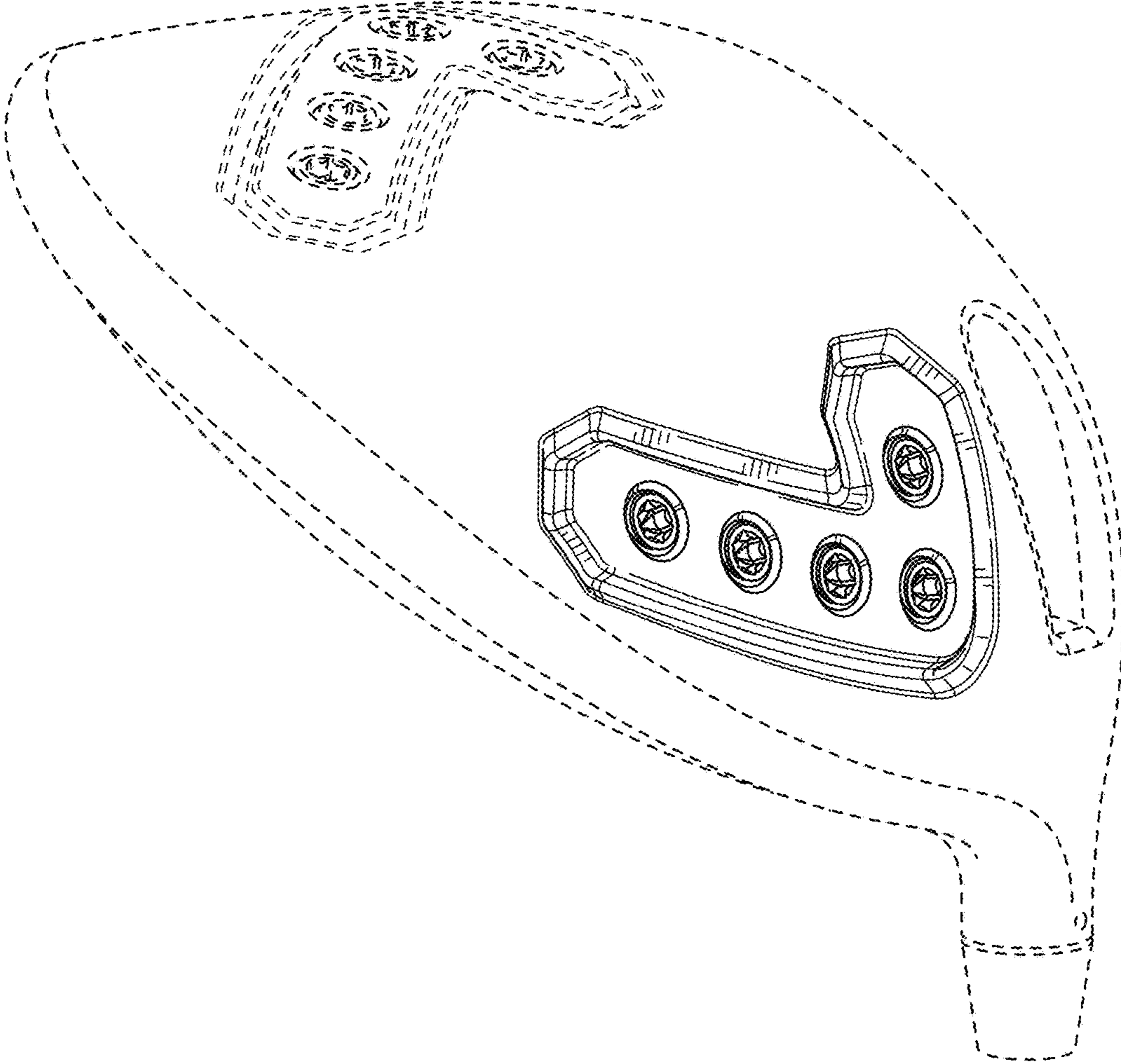

FIG. 18

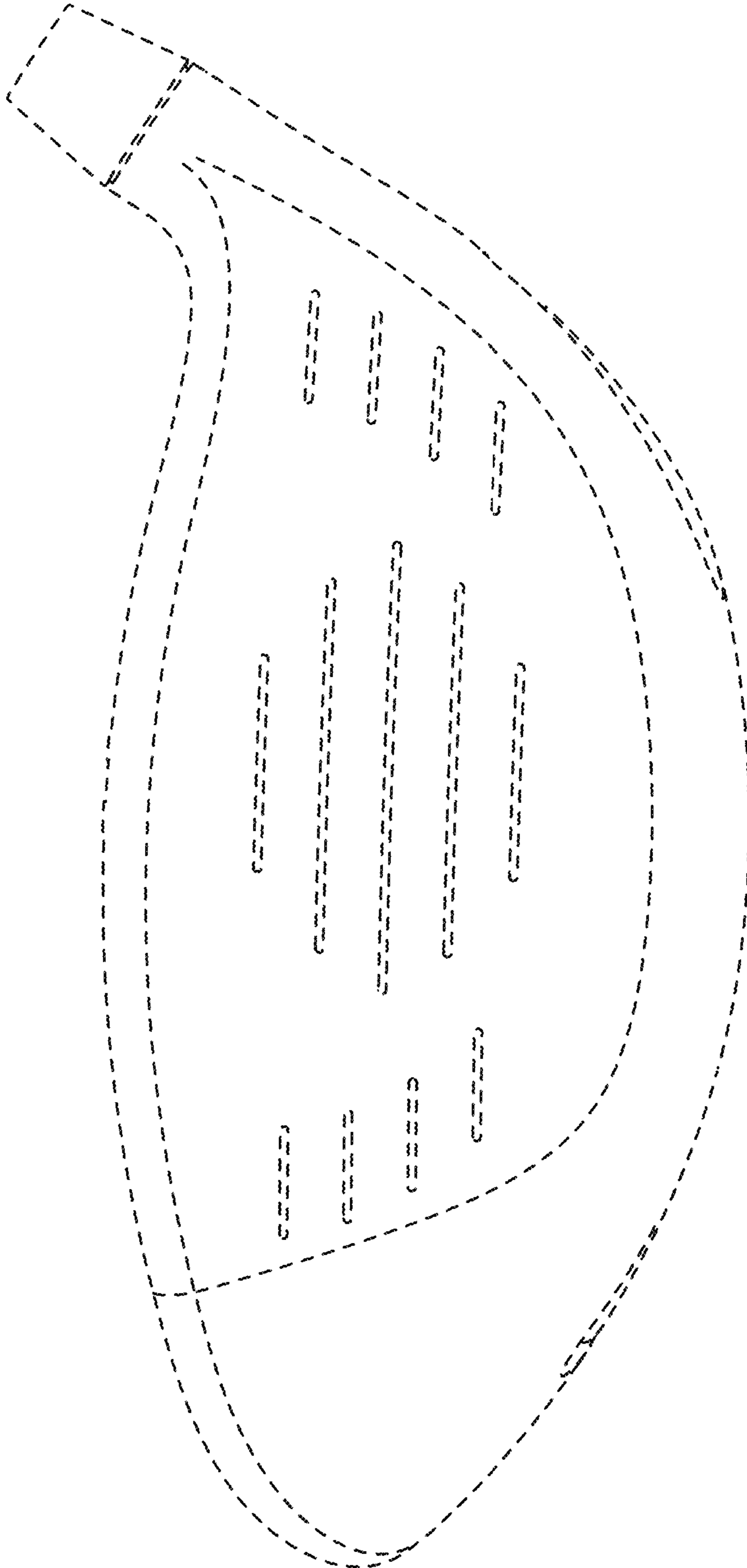

FIG. 19

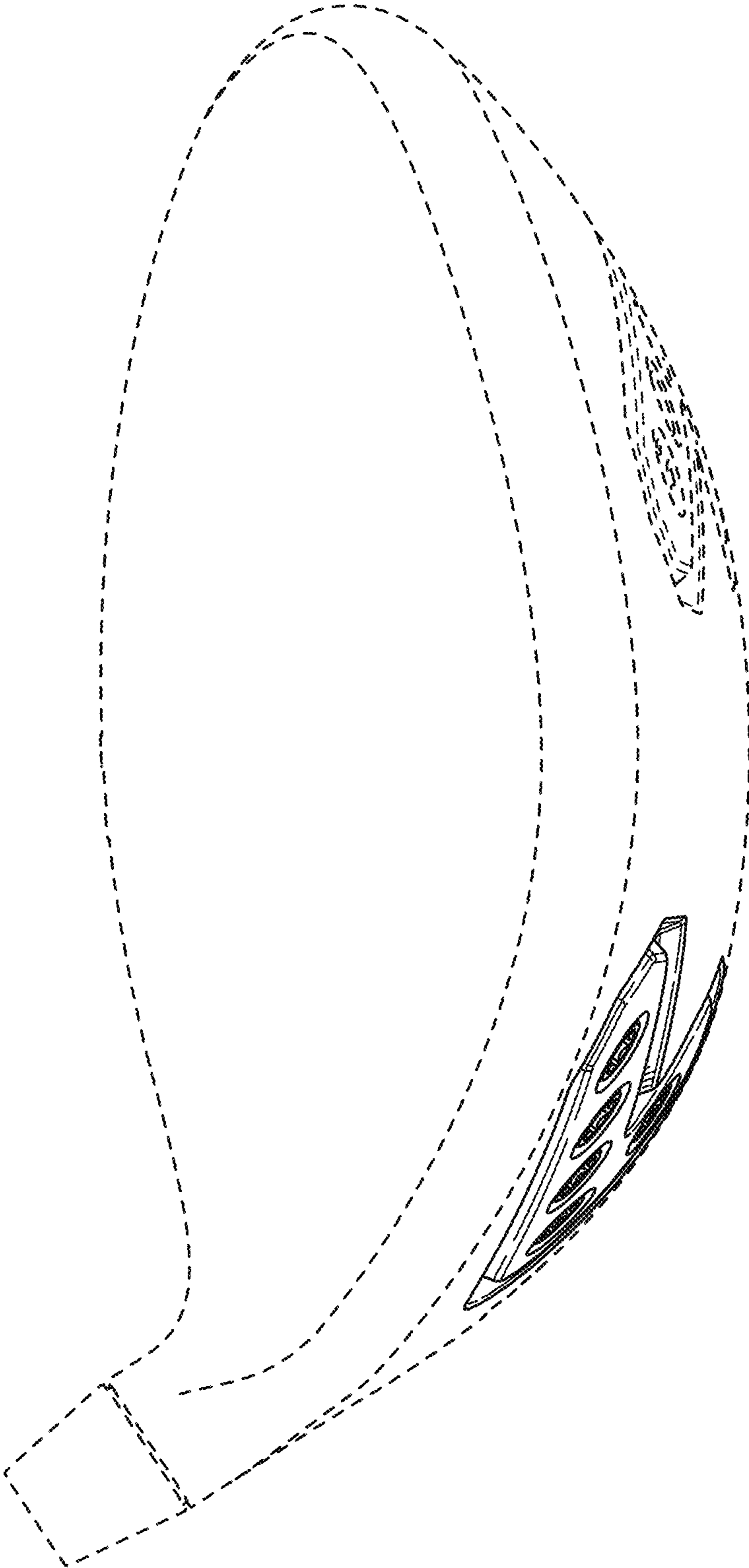

FIG. 20

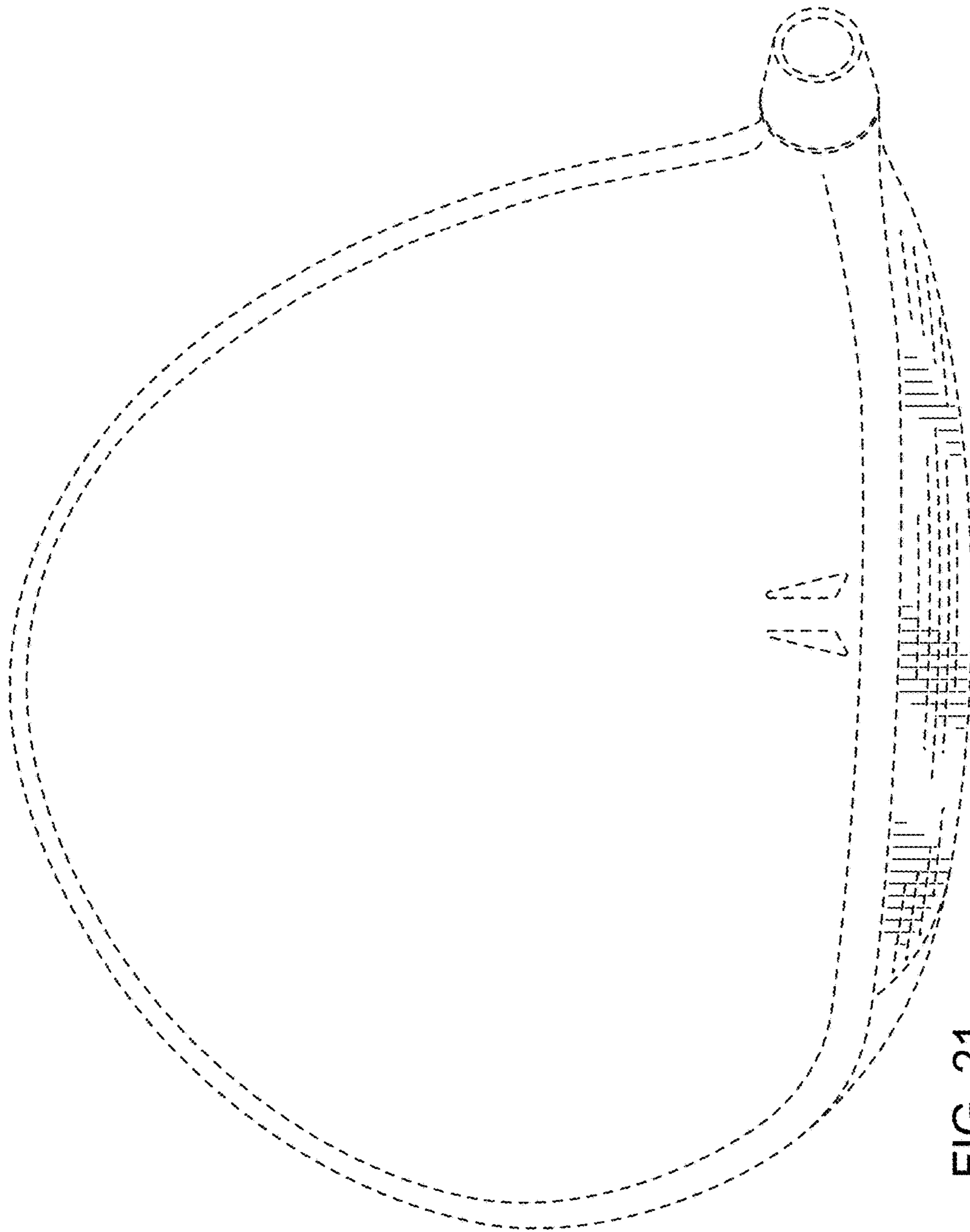

FIG. 21

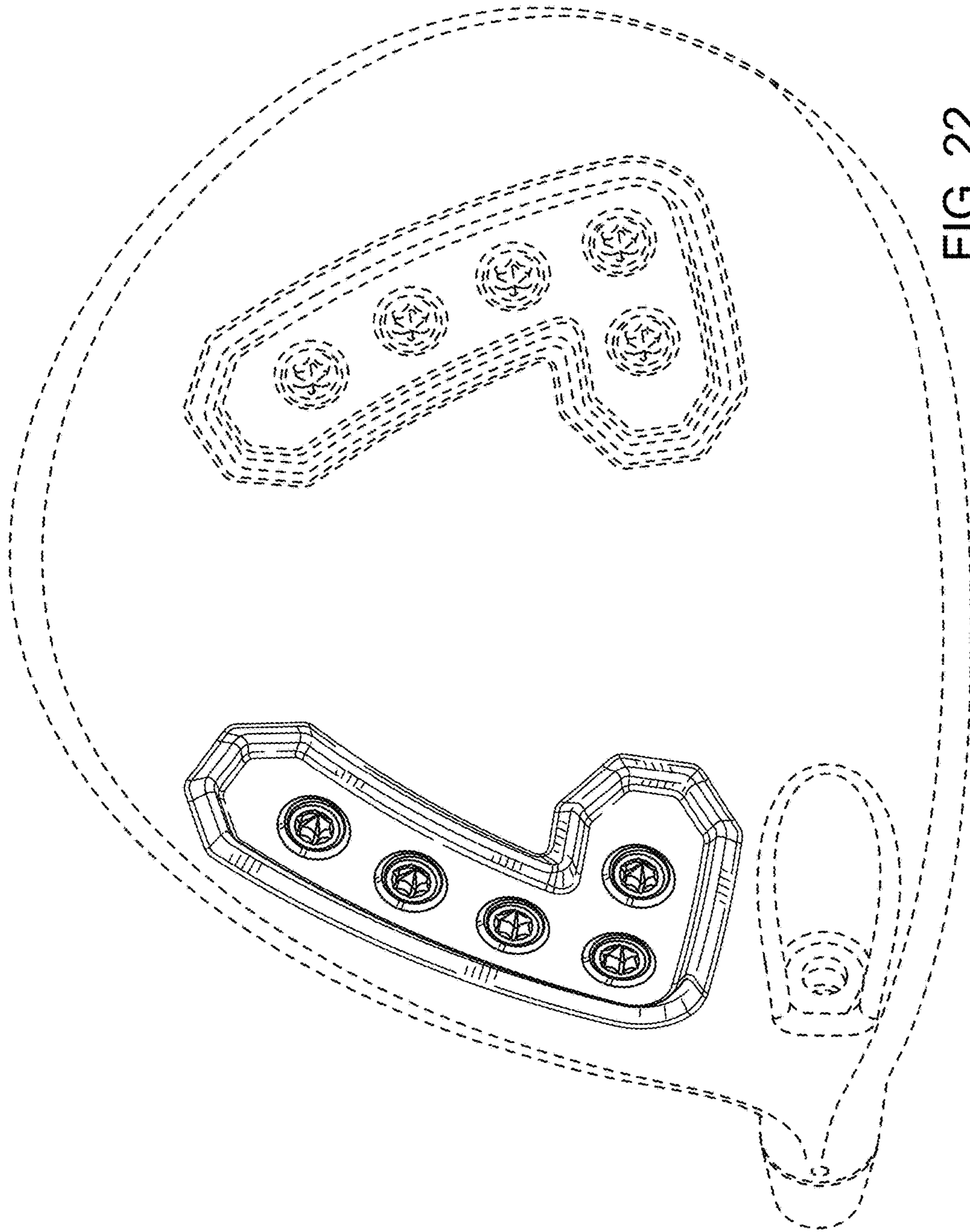

FIG. 22

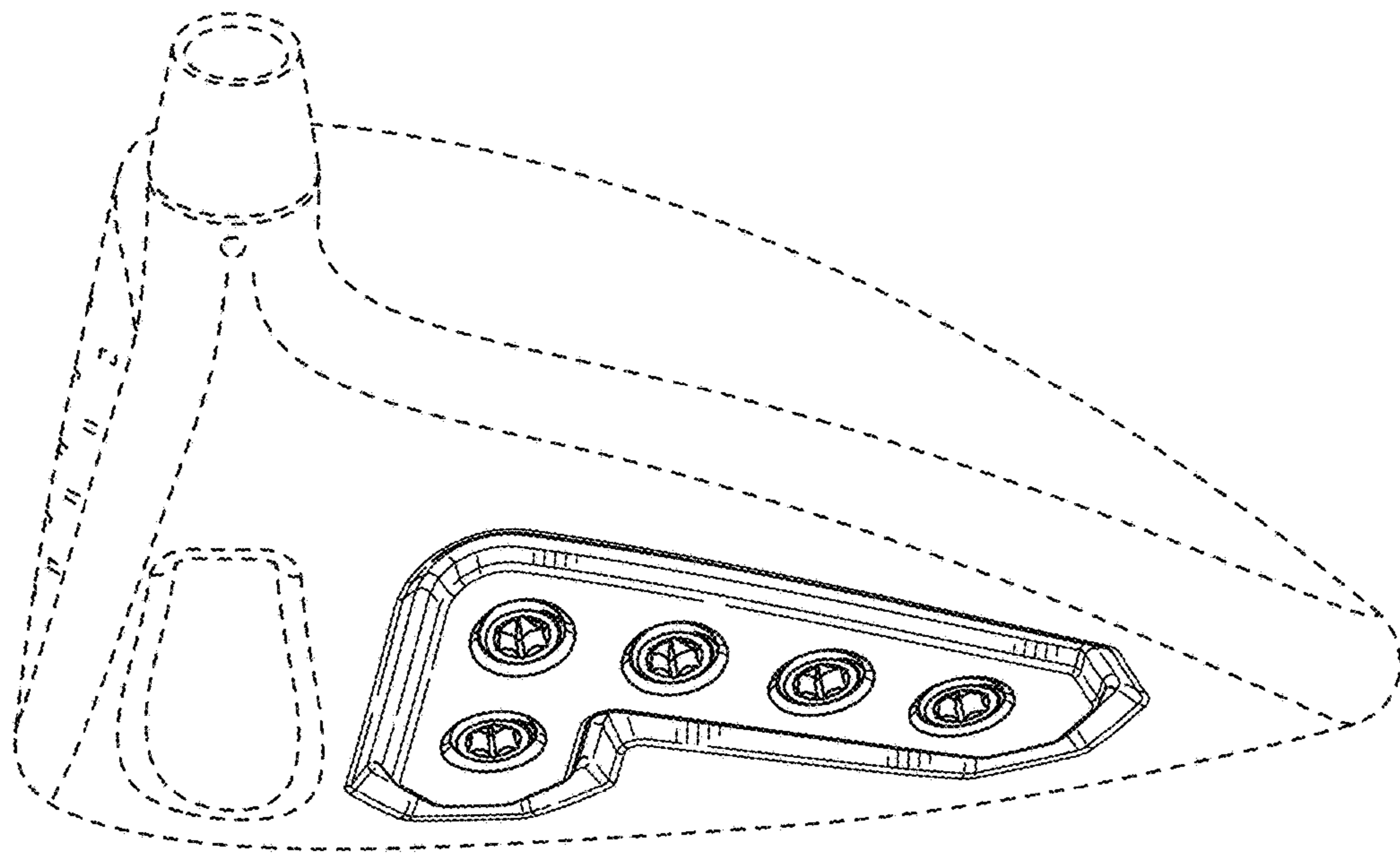

FIG. 23

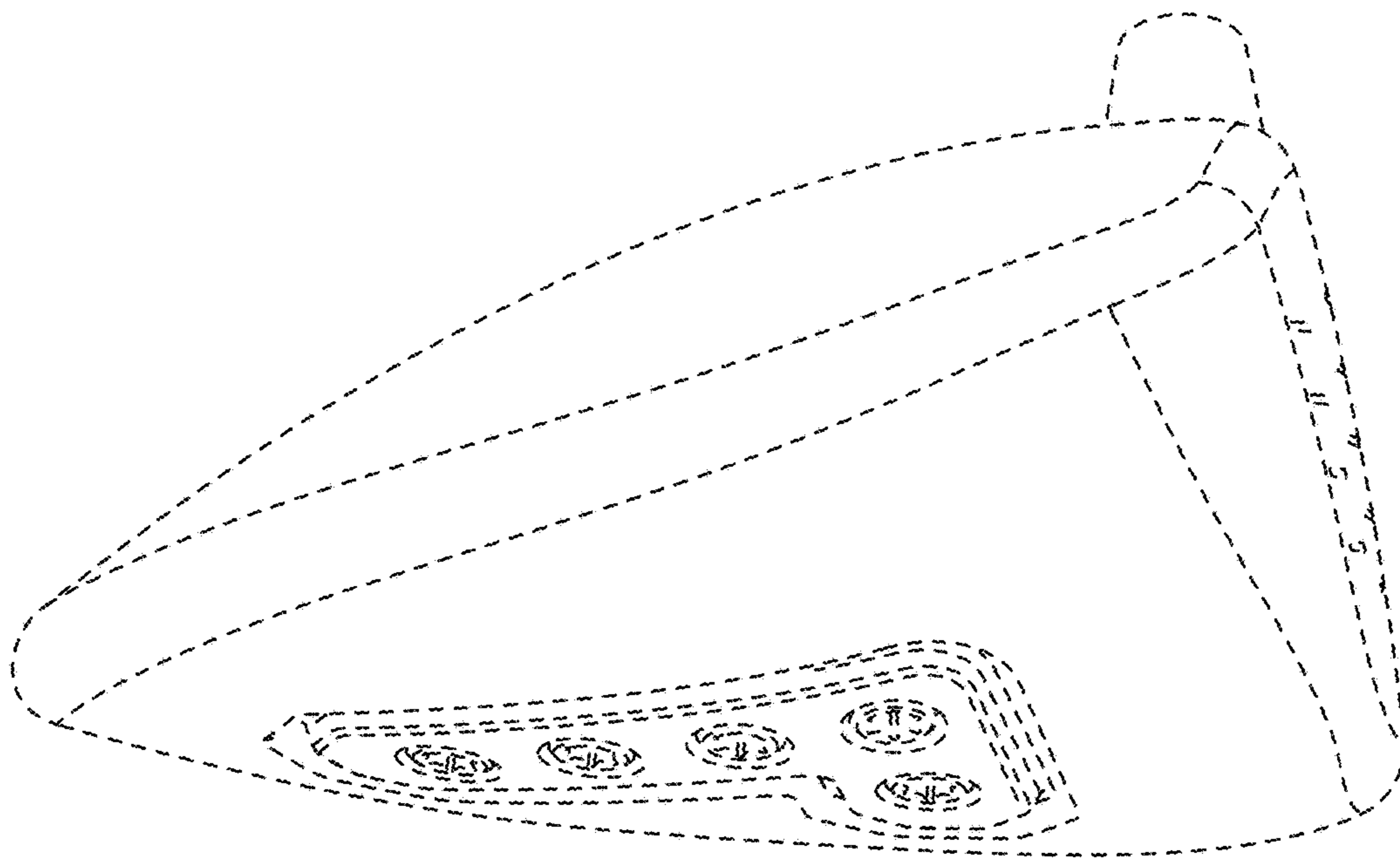

FIG. 24

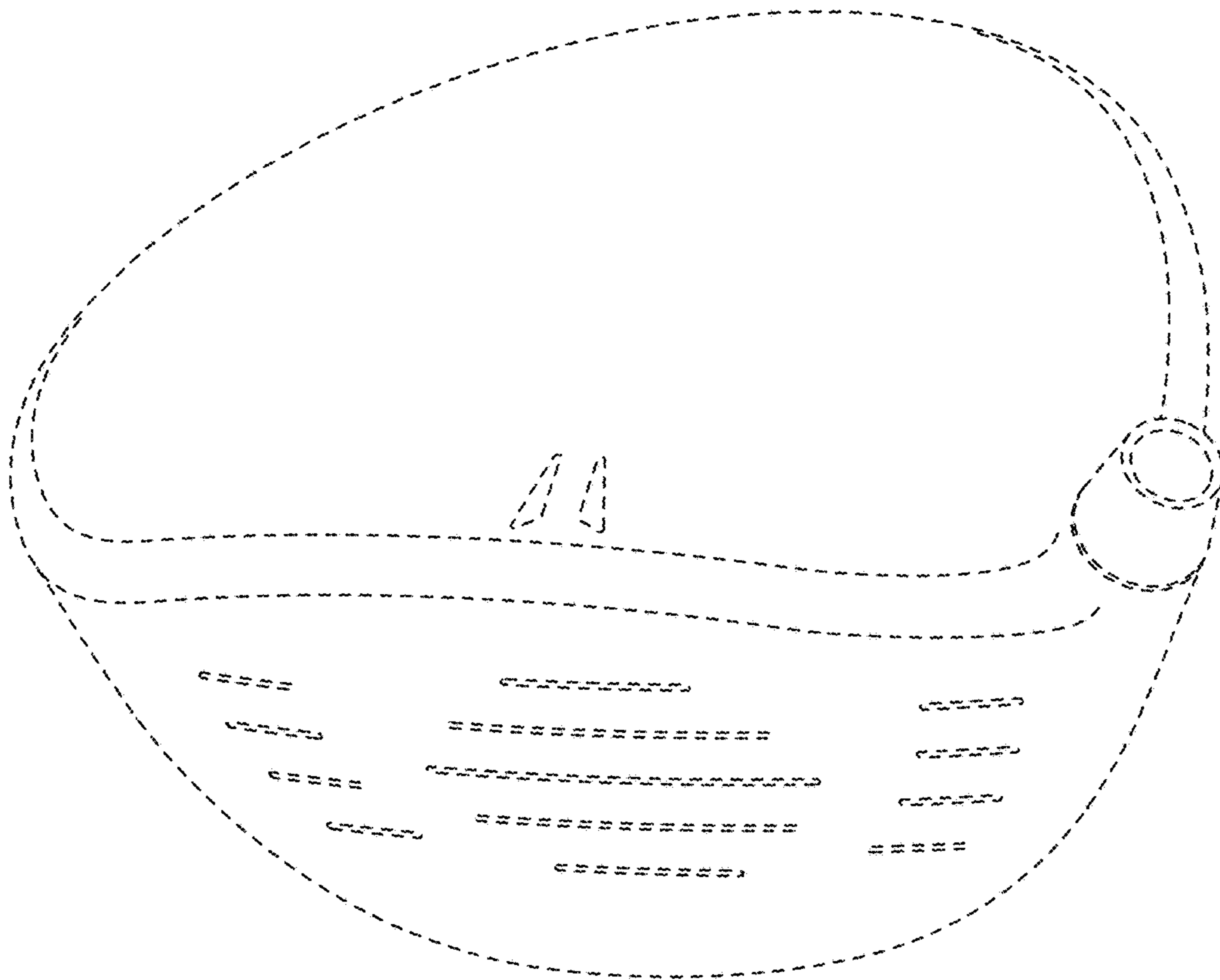

FIG. 25

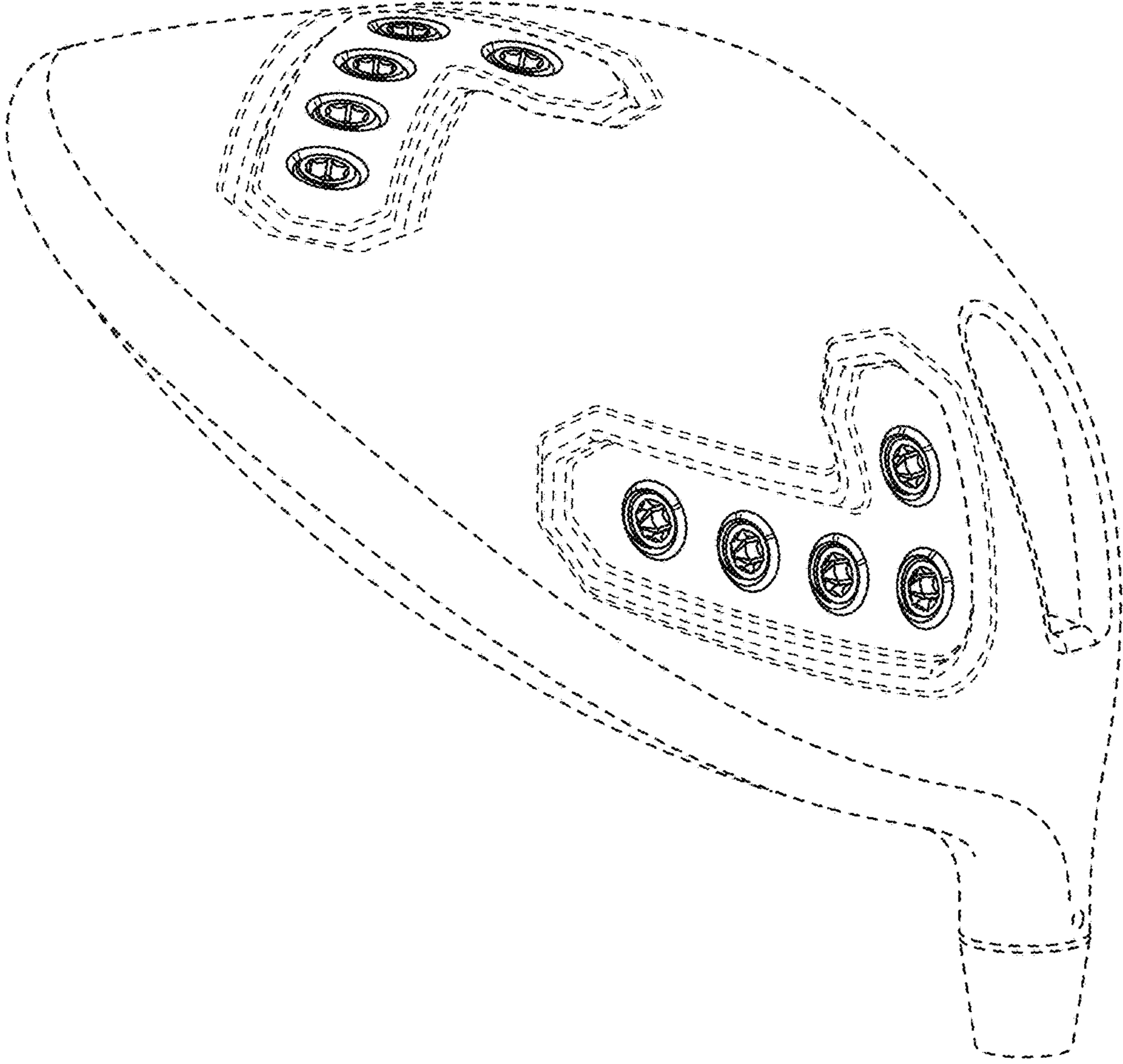

FIG. 26

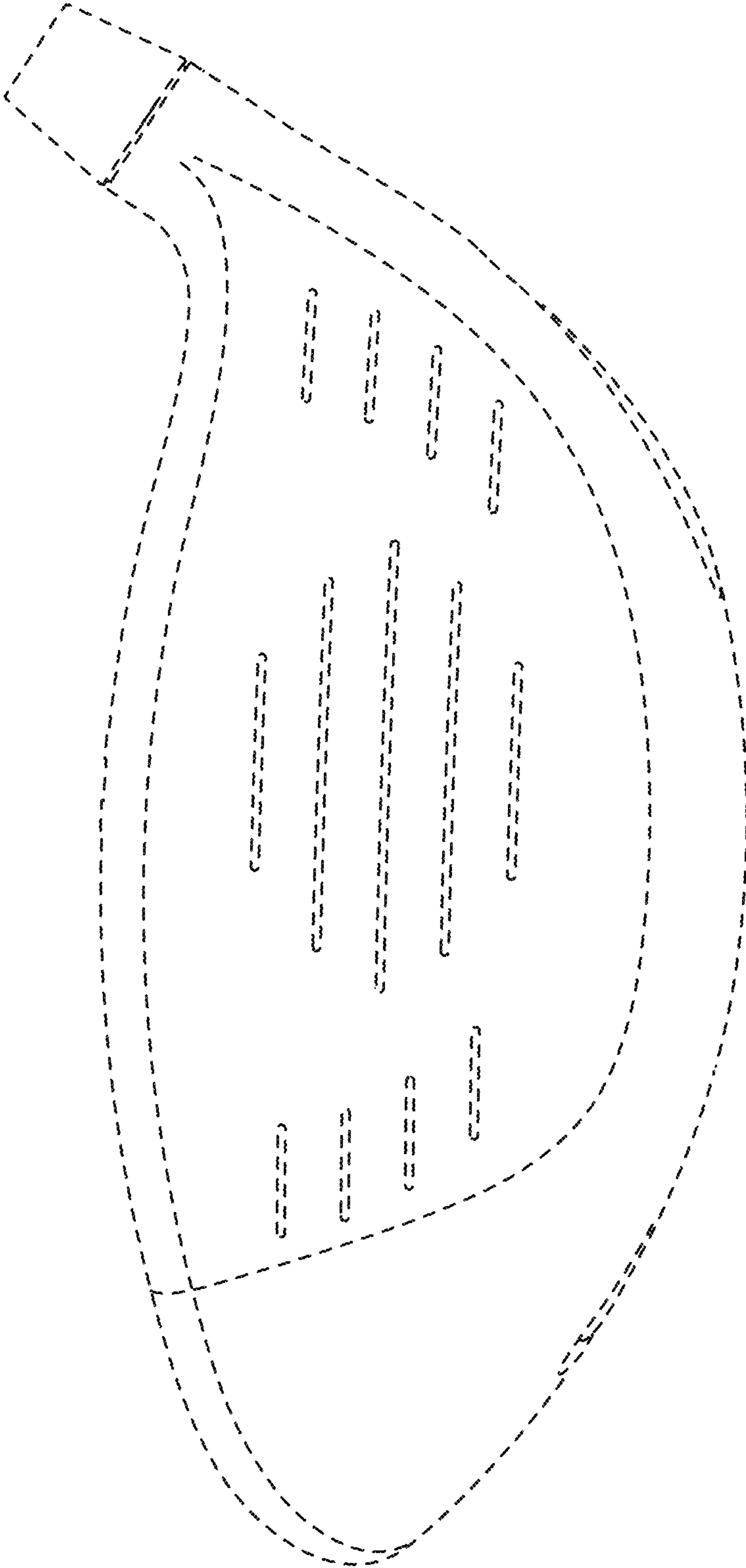

FIG. 27

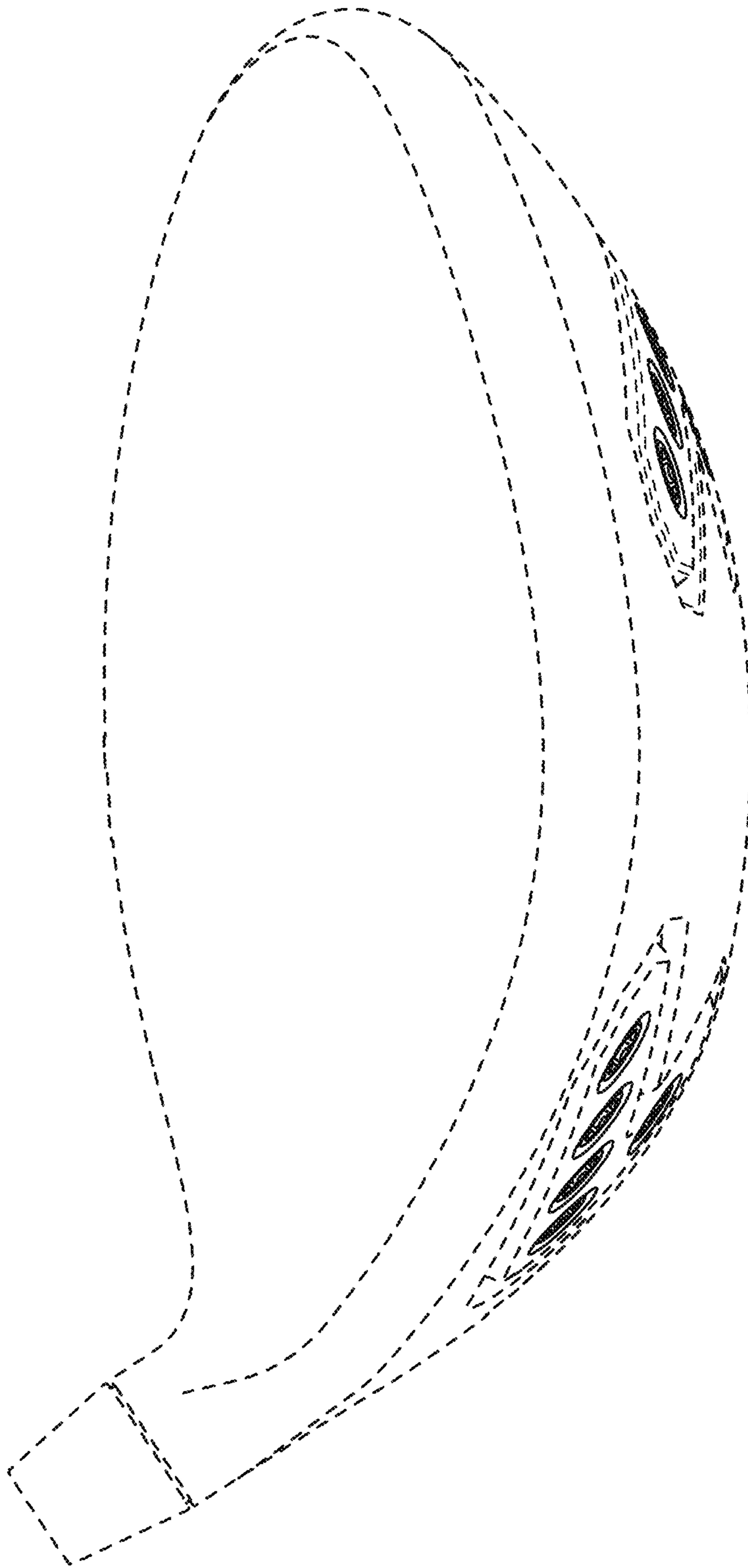

FIG. 28

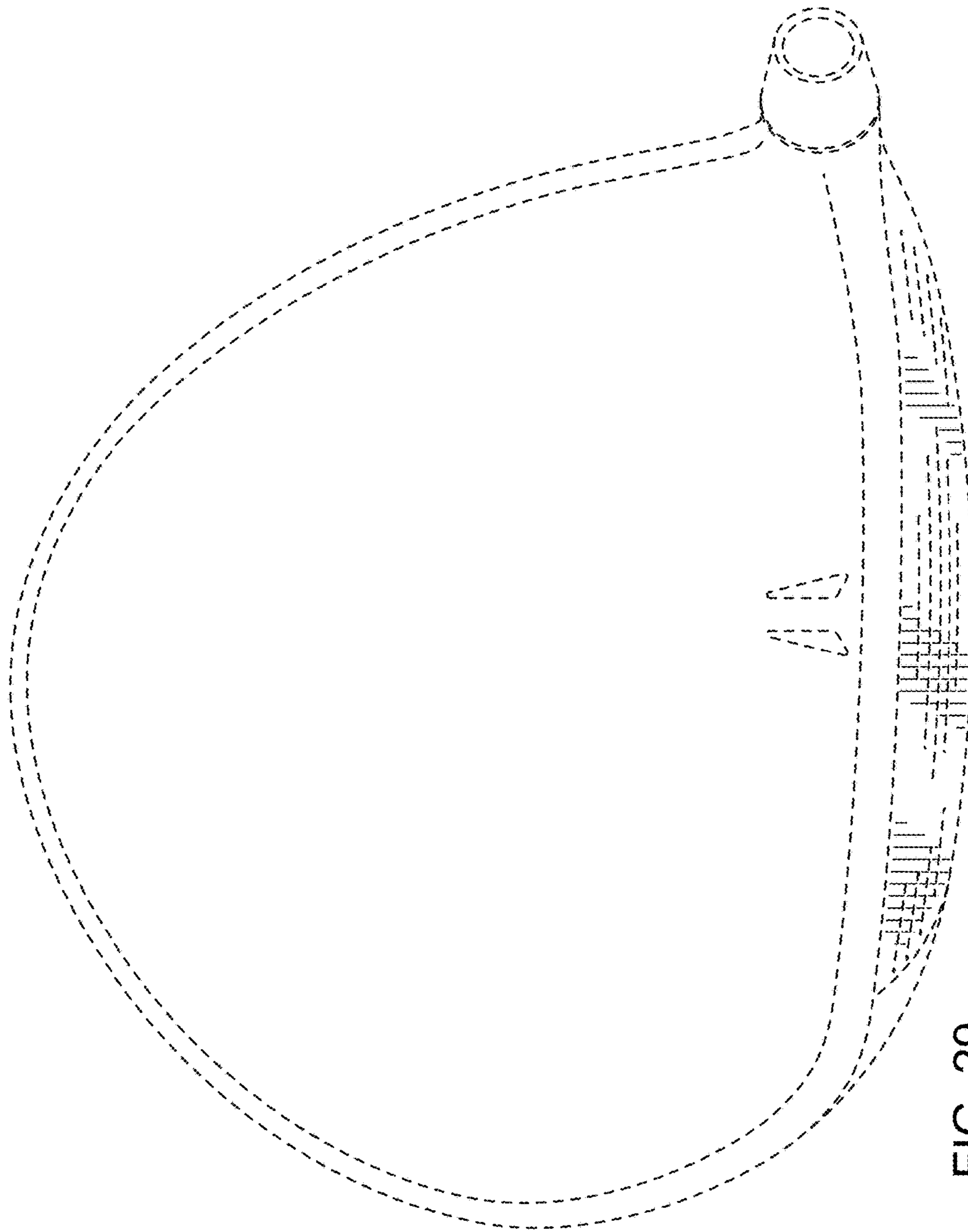

FIG. 29

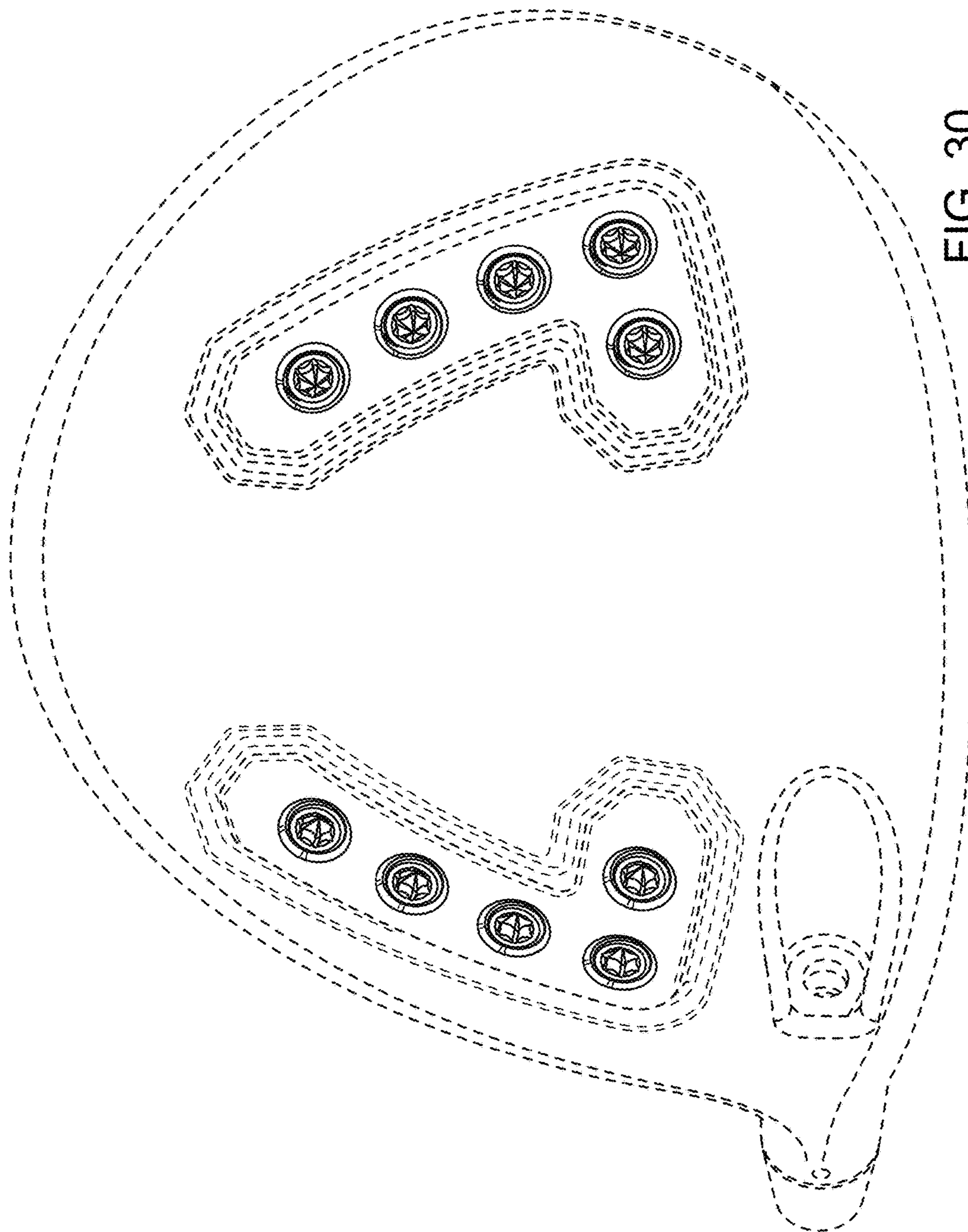

FIG. 30

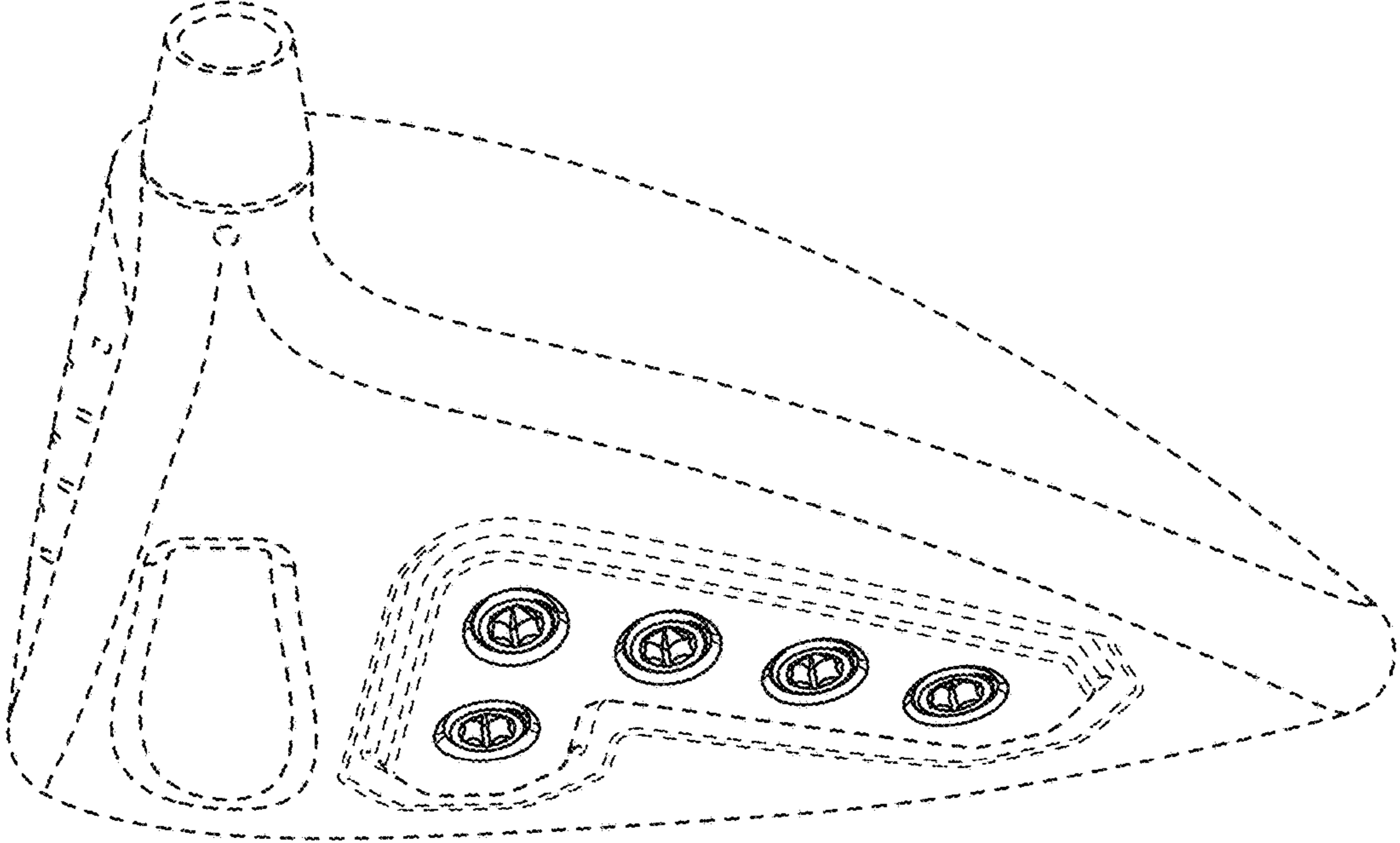

FIG. 31

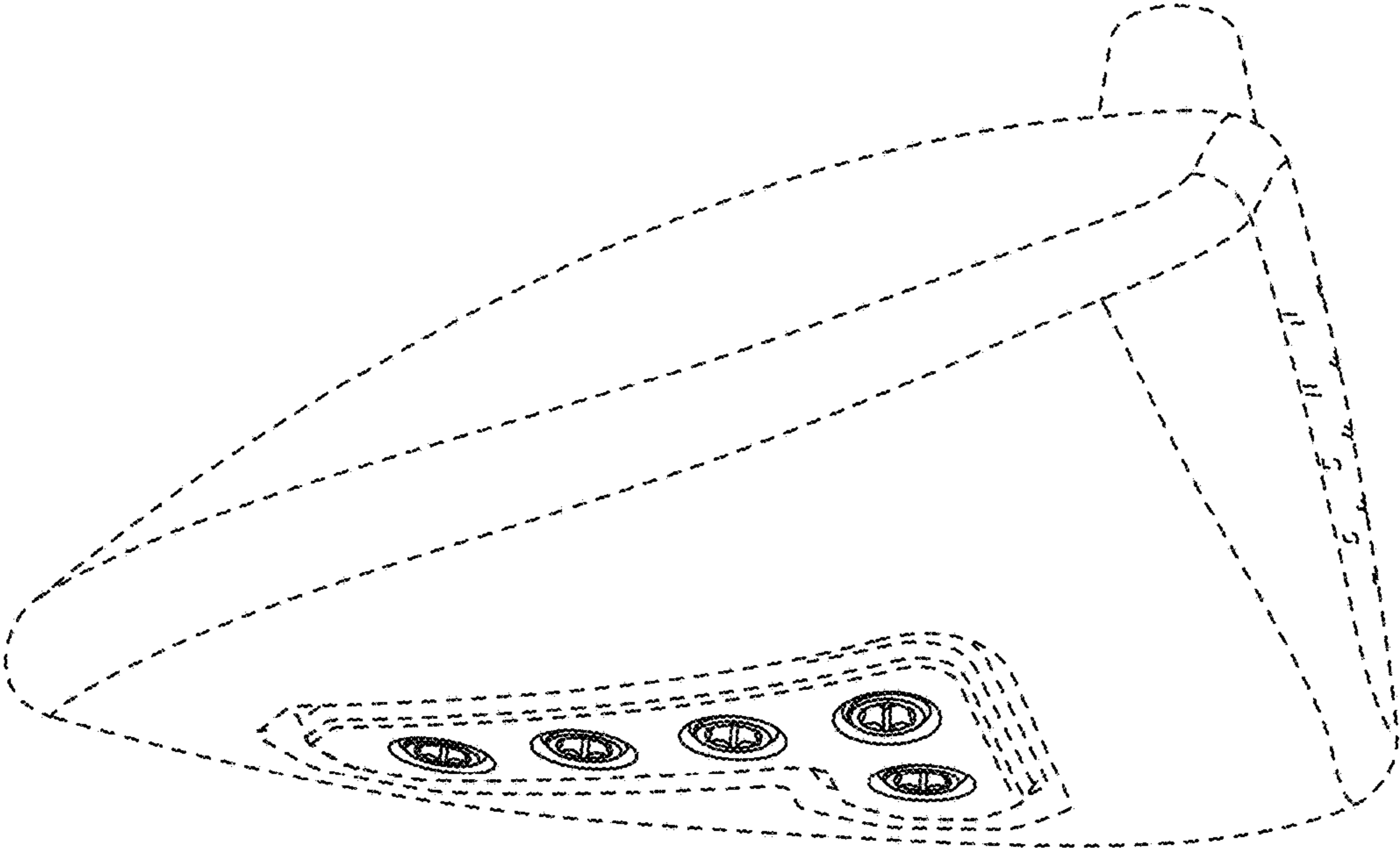

FIG. 32