



US00D823407S

(12) **United States Design Patent** (10) **Patent No.:** **US D823,407 S**
Song et al. (45) **Date of Patent:** **** Jul. 17, 2018**

- (54) **IRON GOLF CLUB HEAD**
- (71) Applicant: **Acushnet Company**, Fairhaven, MA (US)
- (72) Inventors: **Yu-Jin Song**, San Marcos, CA (US);
Ryan J. A. Ritchie, Carlsbad, CA (US)
- (73) Assignee: **Acushnet Company**, Fairhaven, MA (US)
- (**) Term: **15 Years**
- (21) Appl. No.: **29/601,053**
- (22) Filed: **Apr. 18, 2017**
- (51) **LOC (11) Cl.** **21-02**
- (52) **U.S. Cl.**
USPC **D21/747**
- (58) **Field of Classification Search**
USPC D21/747-751, 759
CPC A63B 53/00; A63B 53/02; A63B 53/04;
A63B 53/047; A63B 53/0475; A63B
2053/0479; A63B 2053/0483; A63B
2053/0445; A63B 60/00; A63B 60/46
See application file for complete search history.

- (56) **References Cited**
- U.S. PATENT DOCUMENTS
- | | | | | |
|---------------|---------|-----------|-------|-----------------------|
| D267,965 S * | 2/1983 | Kobayashi | | D21/748 |
| D318,703 S * | 7/1991 | Shearer | | D21/748 |
| D319,091 S * | 8/1991 | Antonious | | D21/749 |
| 5,074,563 A * | 12/1991 | Gorman | | A63B 53/04
473/350 |
| D336,672 S * | 6/1993 | Gorman | | D21/749 |
| D553,699 S * | 10/2007 | Nunez | | D21/747 |
| D554,212 S * | 10/2007 | Nunez | | D21/747 |
| D559,931 S * | 1/2008 | Roach | | D21/747 |

- | | | | | |
|--------------|---------|---------------|-------|---------|
| D598,060 S * | 8/2009 | Barez | | D21/747 |
| D618,293 S * | 6/2010 | Foster | | D21/747 |
| D649,211 S * | 11/2011 | Jertson | | D21/759 |
| D652,093 S * | 1/2012 | Foster | | D21/747 |
| D680,603 S * | 4/2013 | Nicolette | | D21/749 |
| D681,143 S * | 4/2013 | Nicolette | | D21/749 |
| D682,961 S * | 5/2013 | Llewellyn | | D21/747 |
| D725,732 S * | 3/2015 | Westrum | | D21/759 |
| D736,875 S * | 8/2015 | Llewellyn | | D21/759 |
| D737,391 S * | 8/2015 | Wieland | | D21/759 |
| D754,806 S * | 4/2016 | Bacon | | D21/747 |
| D767,695 S * | 9/2016 | Kitching, Jr. | | D21/747 |
| D768,249 S * | 10/2016 | Chun | | D21/747 |
| D788,238 S * | 5/2017 | Foster | | D21/759 |
| D795,370 S * | 8/2017 | Bacon | | D21/759 |
| D803,960 S * | 11/2017 | Hebreo | | D21/749 |
| D809,082 S * | 1/2018 | Kim | | D21/759 |
| D812,169 S * | 3/2018 | Kim | | D21/759 |

* cited by examiner

Primary Examiner — Mitchell I. Siegel
(74) *Attorney, Agent, or Firm* — Randy K. Chang

(57) **CLAIM**

The ornamental design for iron golf club head, as shown and described.

DESCRIPTION

FIG. 1 is a perspective back view of my new design for an iron golf club head;
FIG. 2 is a back view thereof;
FIG. 3 is a top view thereof;
FIG. 4 is a front view thereof;
FIG. 5 is a bottom sole view thereof;
FIG. 6 is a heel view thereof; and,
FIG. 7 is a toe view thereof.
The broken line showing is included for the purpose of illustrating and forms no part of the claimed design.

1 Claim, 3 Drawing Sheets

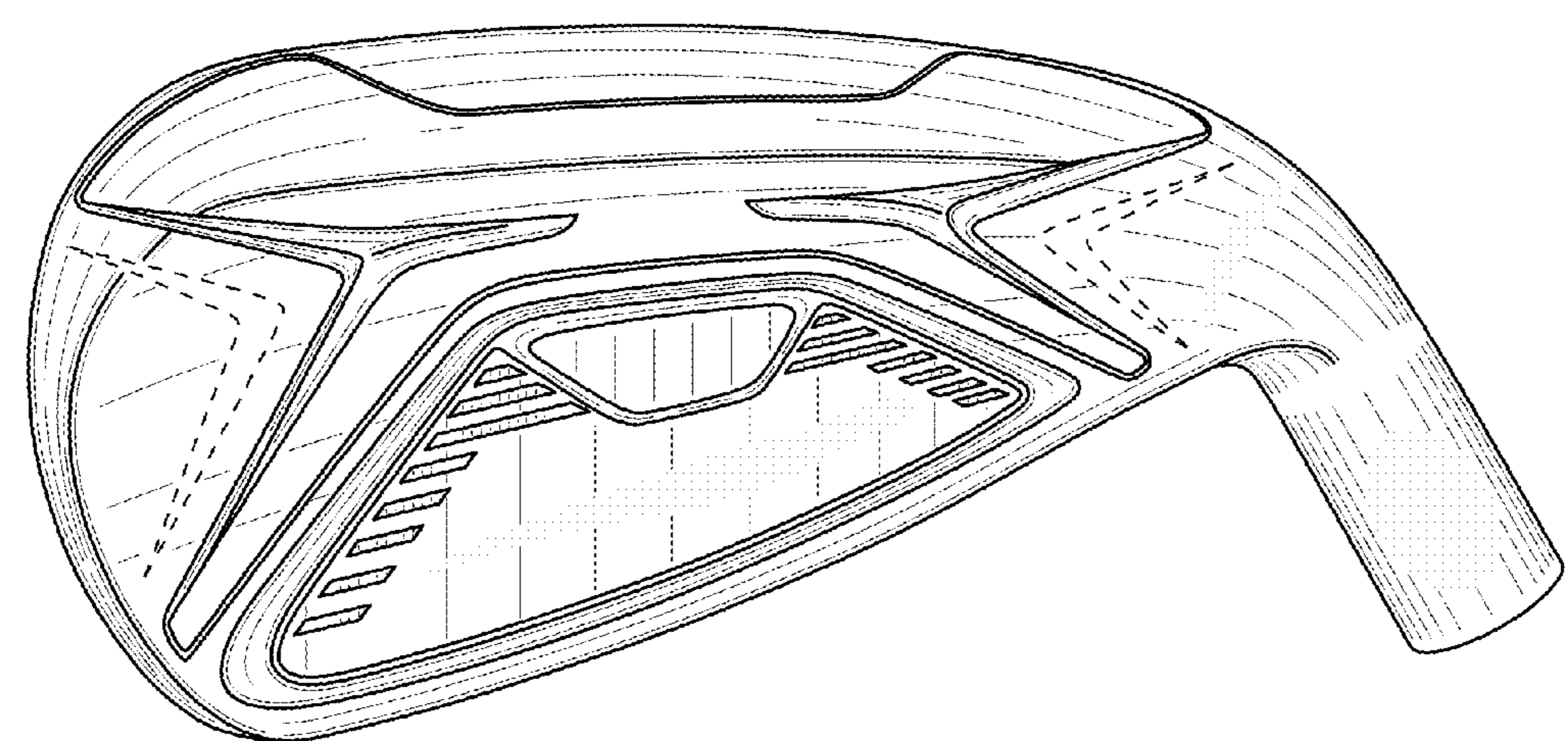

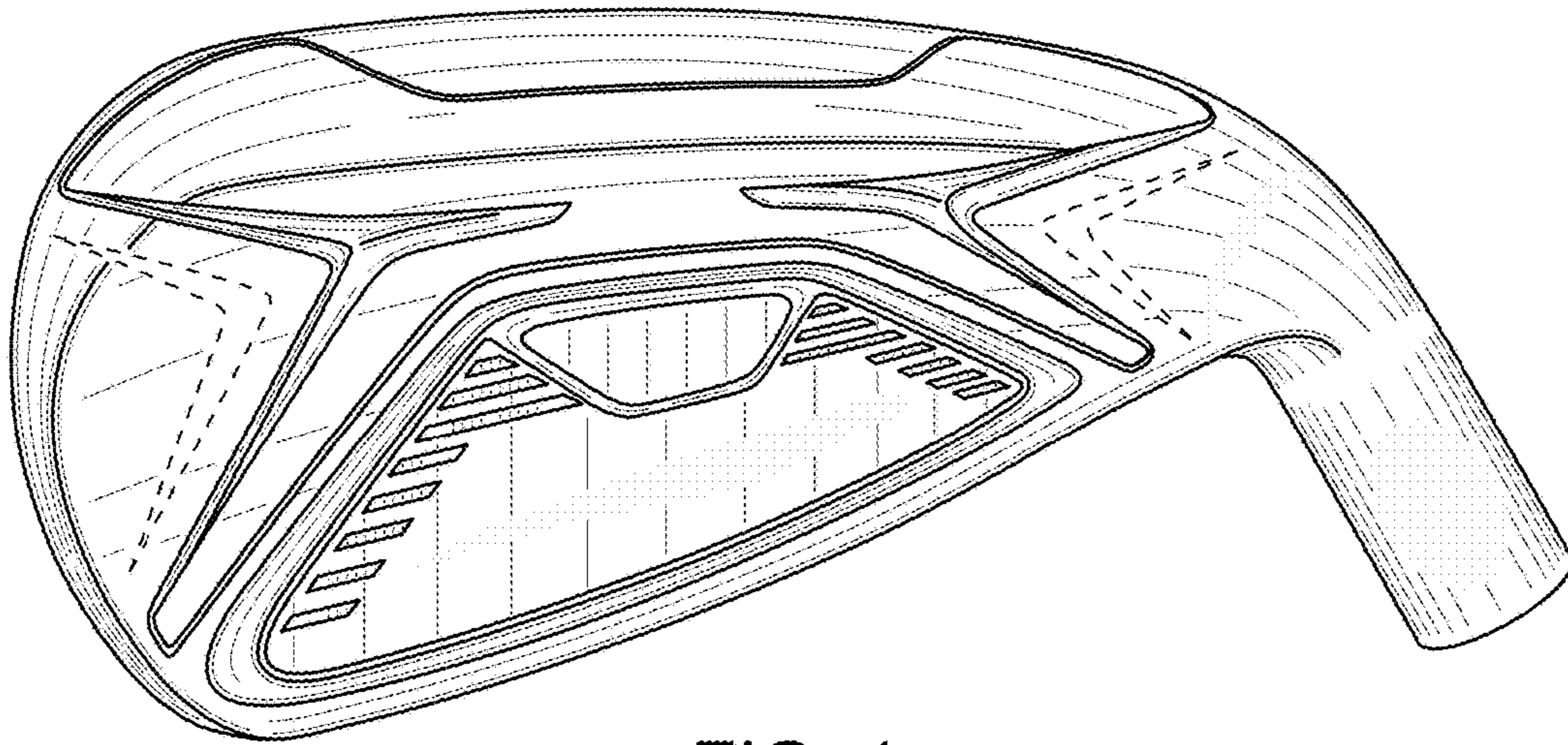

FIG. 1

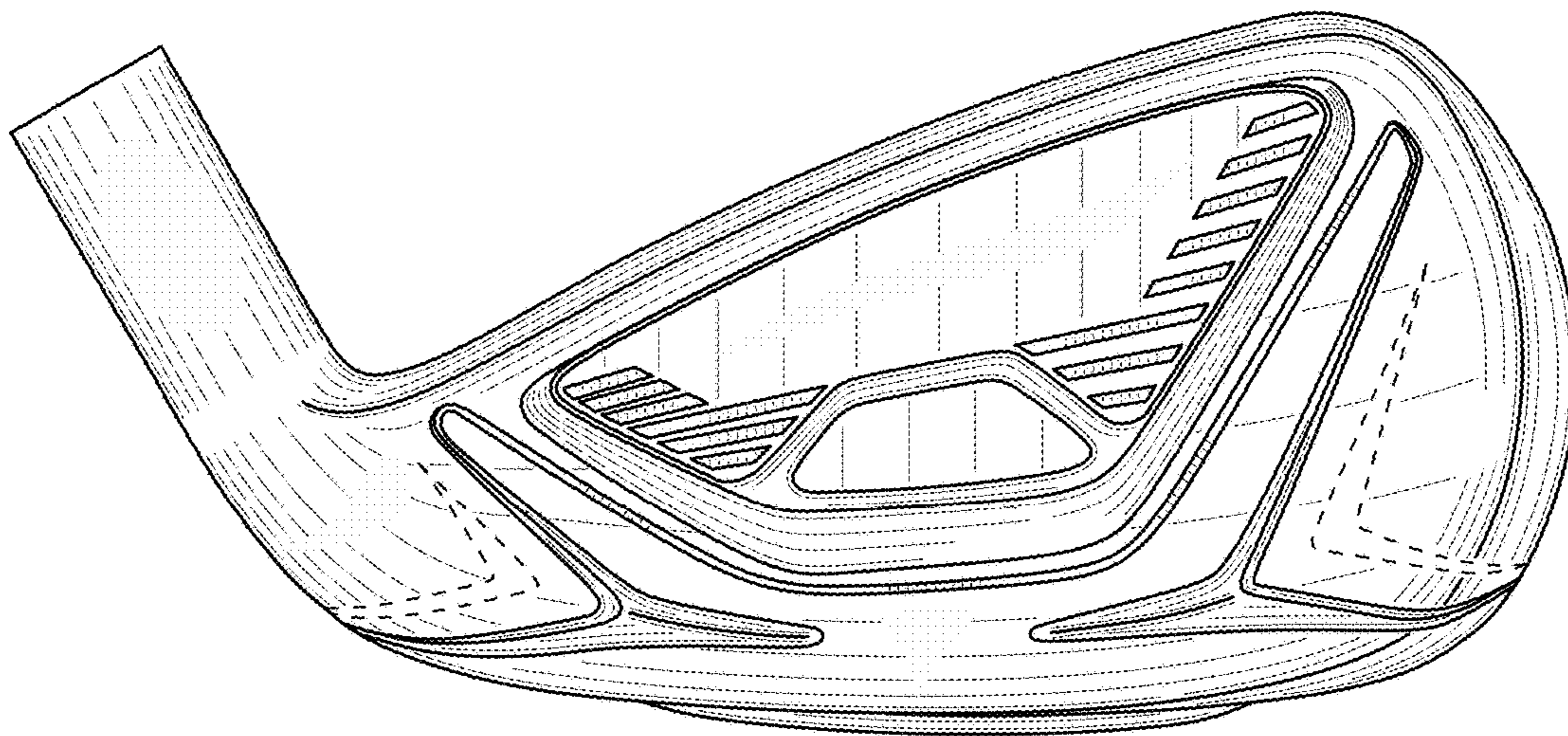

FIG. 2

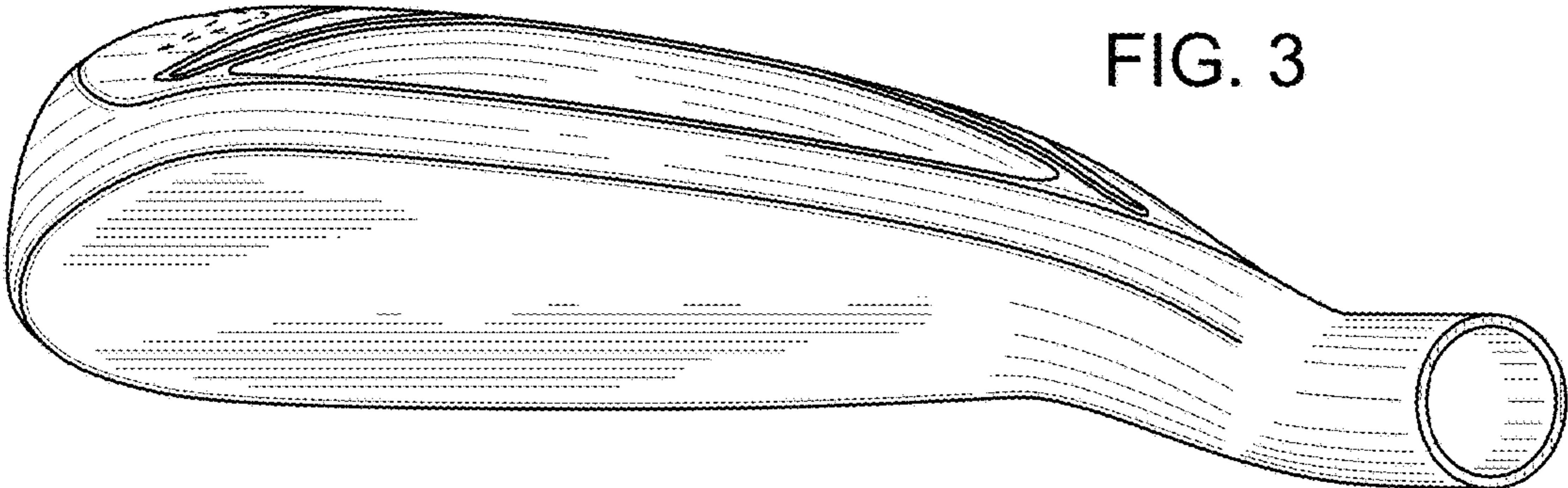

FIG. 3

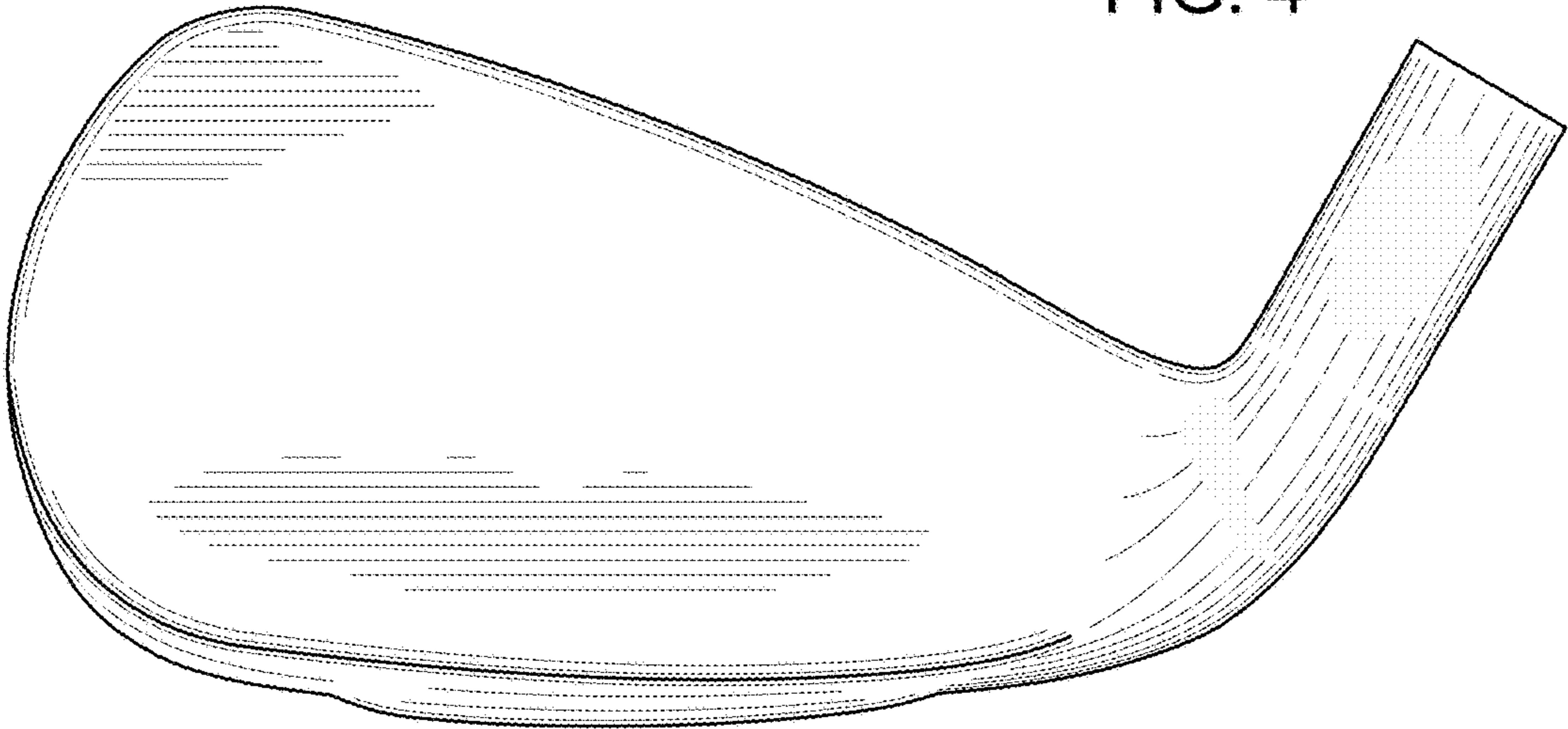

FIG. 4

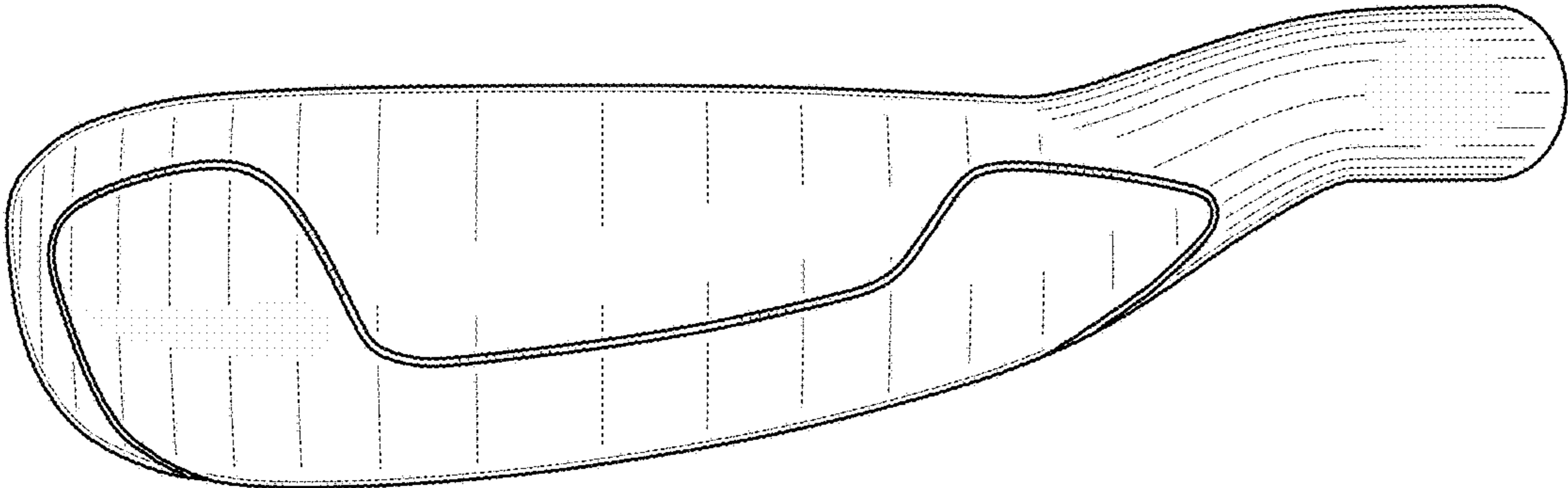

FIG. 5

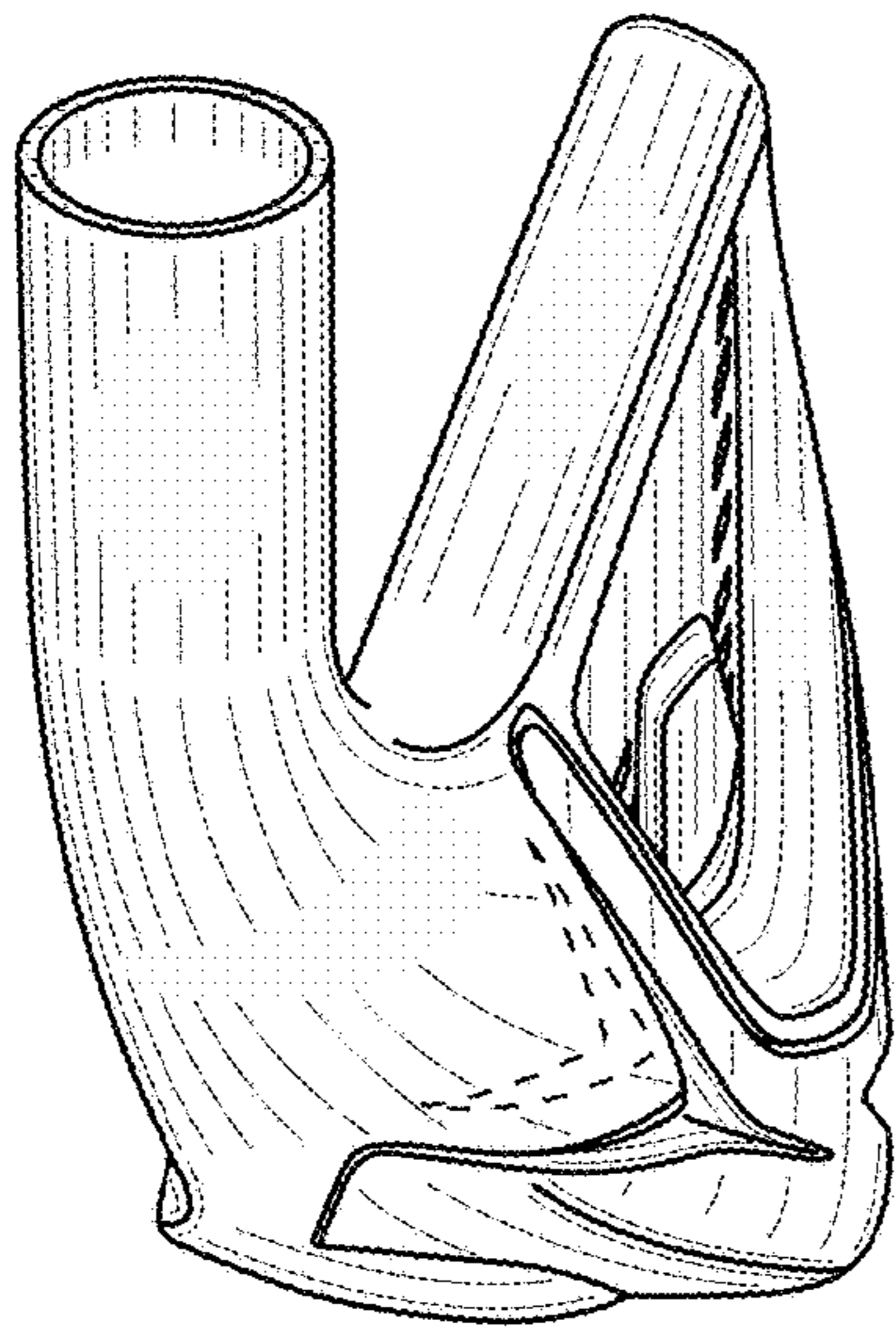

FIG. 6

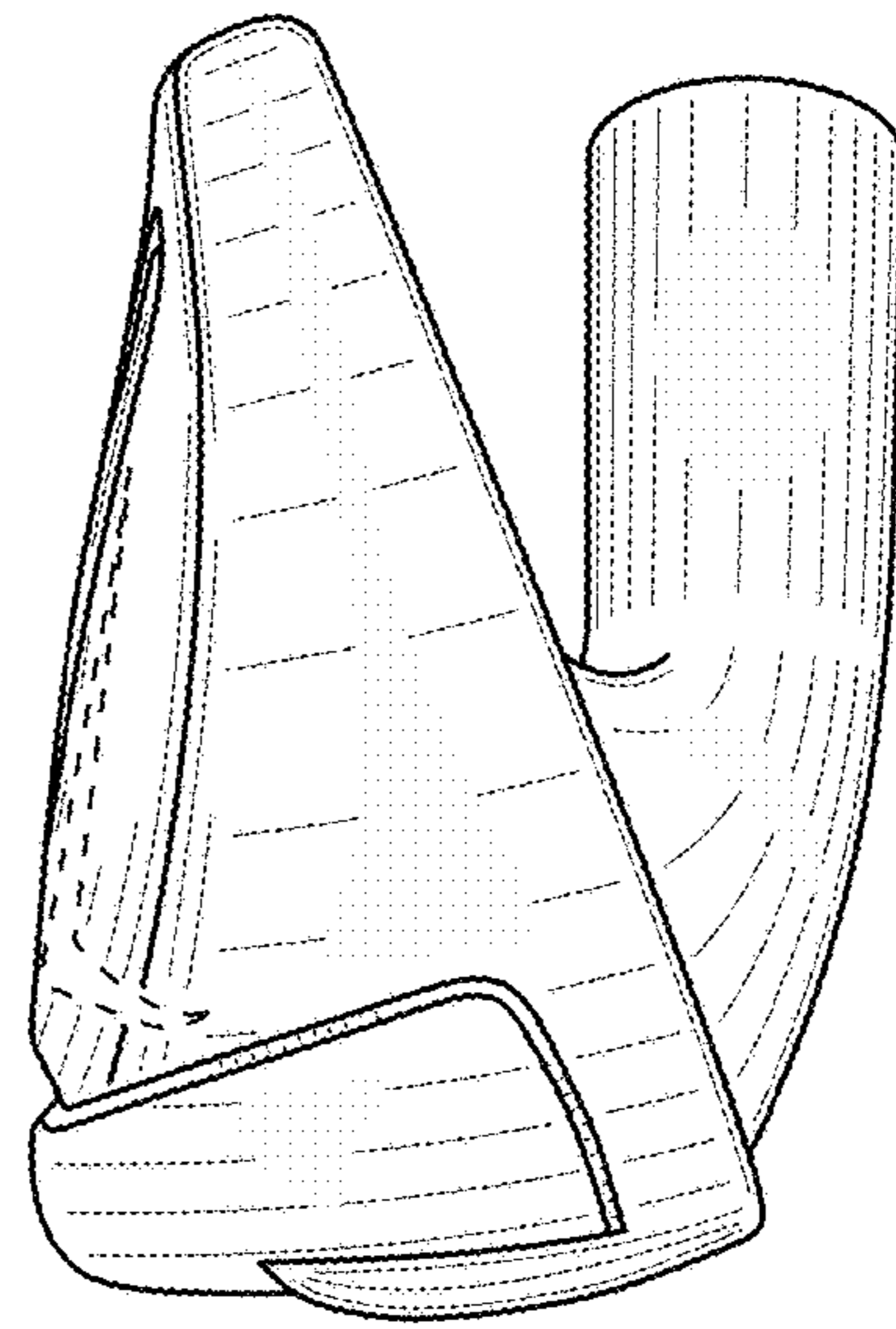

FIG. 7