



US00D823277S

(12) **United States Design Patent** (10) **Patent No.:** **US D823,277 S**
Hagenauer (45) **Date of Patent:** **** Jul. 17, 2018**

(54) **BABY MONITOR** D649,135 S * 11/2011 Hocherman D14/159
D656,478 S * 3/2012 Barley D14/159
(71) Applicant: **KONINKLIJKE PHILIPS N.V.**, D665,767 S * 8/2012 Hancock D14/159
Eindhoven (NL) D668,239 S * 10/2012 Marsh D14/159
D675,584 S * 2/2013 Sharp D14/126
(72) Inventor: **Georg Johann Hagenauer**, Amsterdam D681,600 S * 5/2013 Gebski D14/159
(NL) D681,601 S * 5/2013 Gebski D14/159
D735,690 S * 8/2015 Sharp D14/159
D740,781 S * 10/2015 Thomas D14/159
(73) Assignee: **KONINKLIJKE PHILIPS N.V.**, D740,782 S * 10/2015 Thomas D14/159
Eindhoven (NL) D745,167 S * 12/2015 Canas D10/78
D763,220 S * 8/2016 Deng D14/159
D763,817 S * 8/2016 Deng D14/159
(**) Term: **15 Years** 2007/0241911 A1 * 10/2007 Swan G08B 13/19621
340/573.1
(21) Appl. No.: **35/501,137** 2013/0278419 A1 * 10/2013 D'Antonio G08B 21/0202
340/539.15
(22) Filed: **Dec. 29, 2015**

* cited by examiner

(80) **Hague Agreement Data**

Int. Filing Date: **Dec. 29, 2015**
Int. Reg. No.: **DM/088838**
Int. Reg. Date: **Dec. 29, 2015**
Int. Reg. Pub. Date: **Jul. 1, 2016**

Primary Examiner — Melanie H Tung
Assistant Examiner — Bao-Yen T Nguyen

(51) **LOC (11) Cl.** **14-03**
(52) **U.S. Cl.**
USPC **D14/159**

(57) **CLAIM**

The ornamental design for baby monitor, as shown and described.

(58) **Field of Classification Search**
USPC D14/137, 154, 155, 156, 158, 159, 160,
D14/161, 162, 163, 164, 165, 167, 168,
D14/188, 192, 253, 496
CPC G08B 13/19621; G08B 13/19684; G08B
21/0208; G08B 21/0476; H04N 5/23216;
H04N 7/183
See application file for complete search history.

DESCRIPTION

1. Baby monitor
1.1 is a perspective view showing the baby monitor my design;
1.2 is a front elevational view thereof;
1.3 is a rear elevations view thereof;
1.4 is a left side elevational view thereof;
1.5 is a right side elevational view thereof;
1.6 is a top plan view thereof; and
1.7 is a bottom plan view thereof.

(56) **References Cited**

U.S. PATENT DOCUMENTS

D497,149 S * 10/2004 Daniels D10/104.1
D637,174 S * 5/2011 Elkerbout D14/159

1 Claim, 7 Drawing Sheets

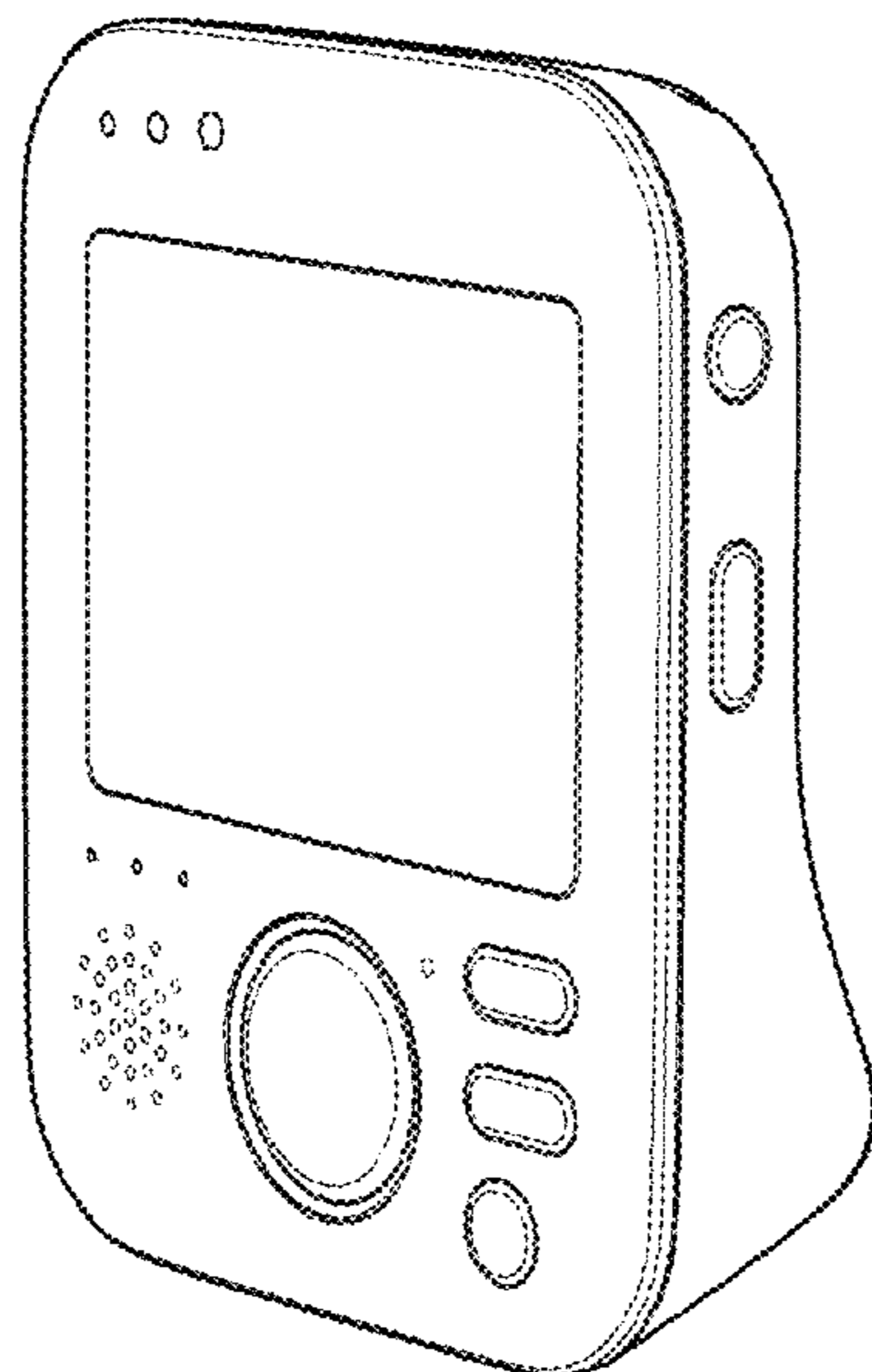

1.1

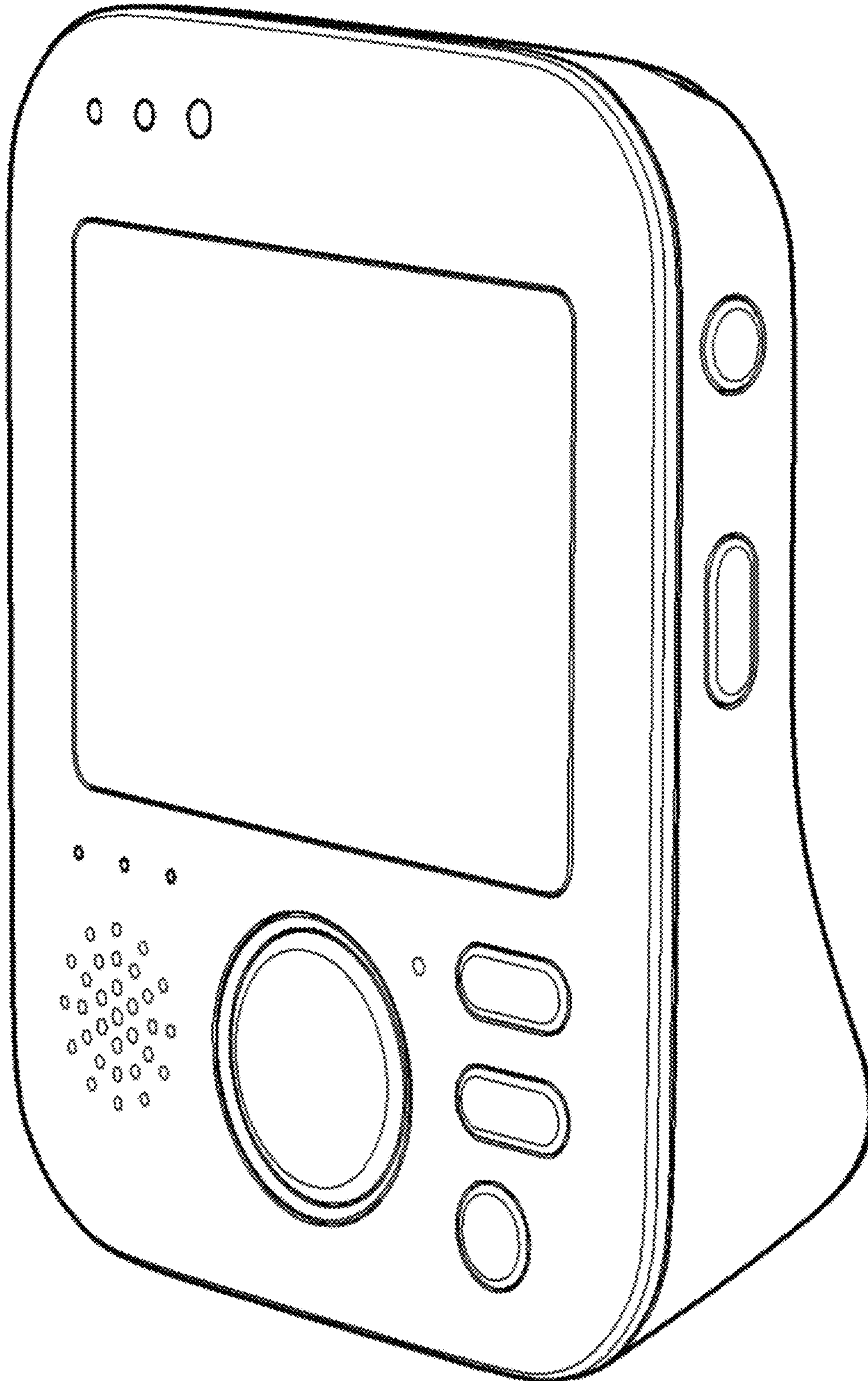

1.2

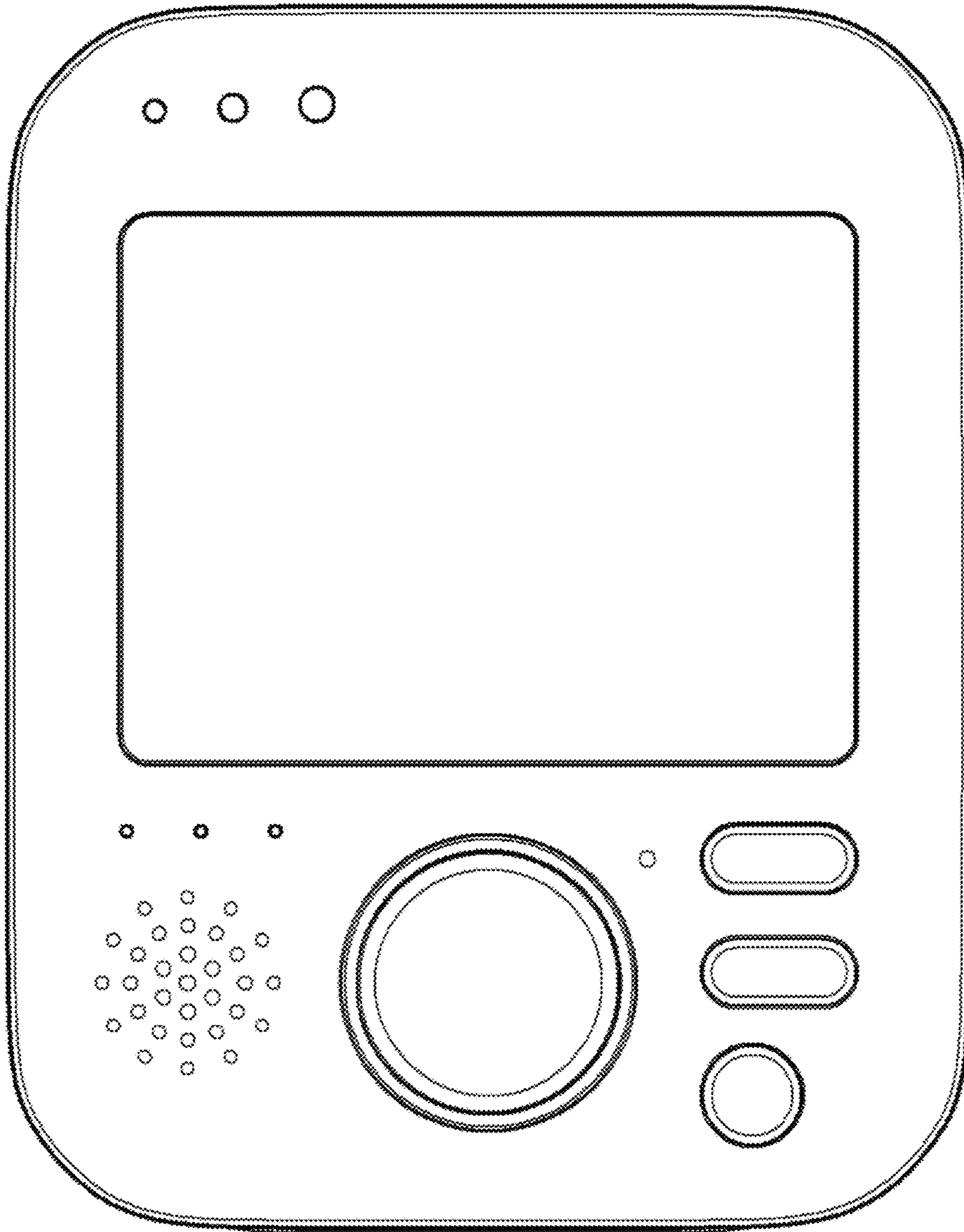

1.3

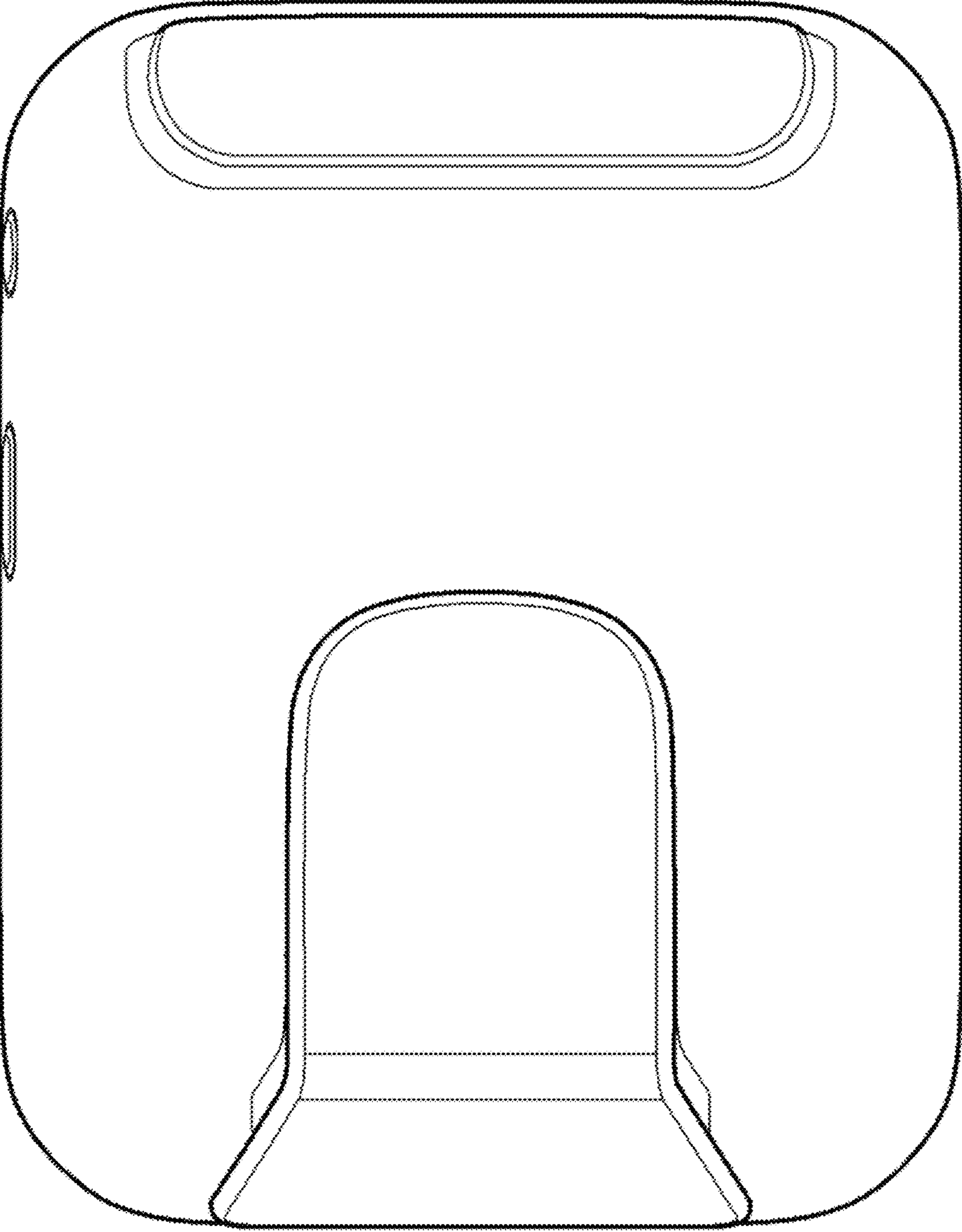

1.4

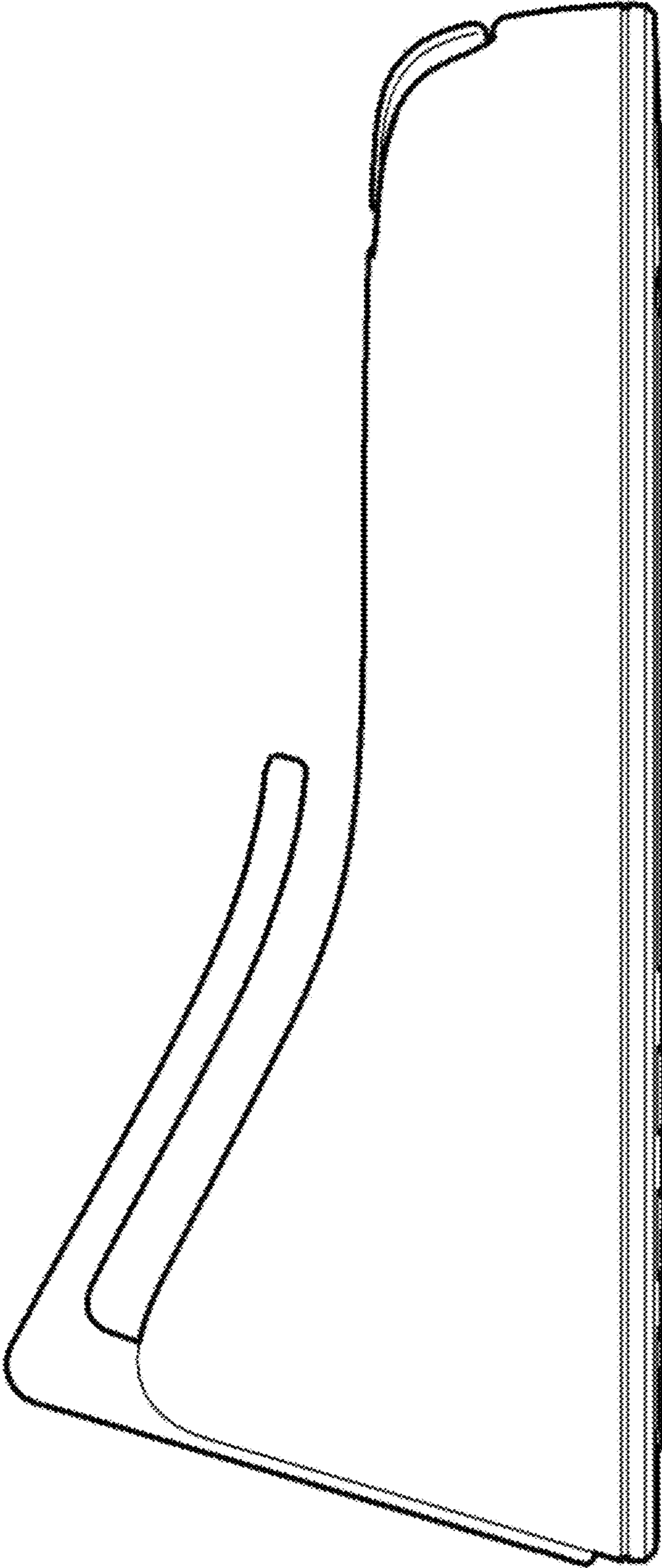

1.5

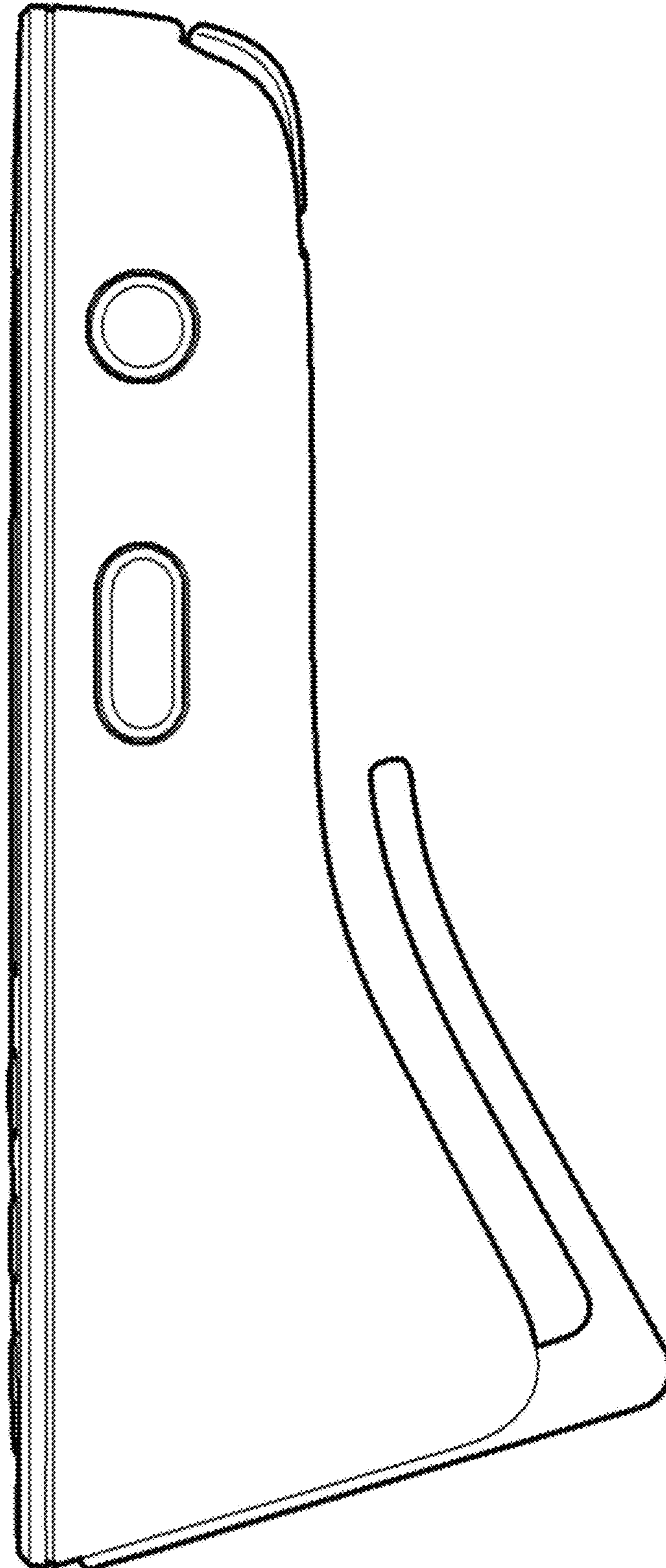

1.6

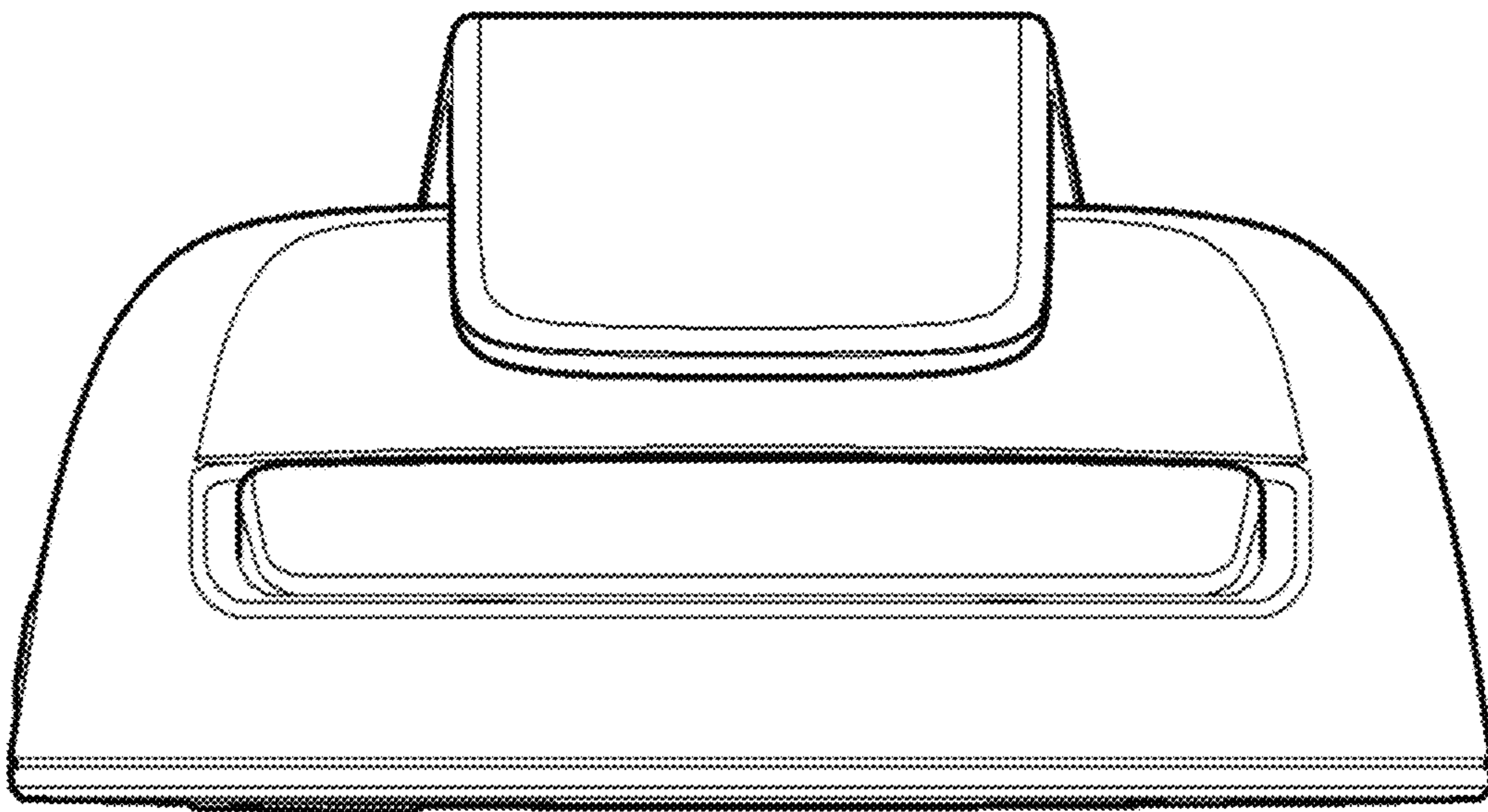

1.7

