



US00D823213S

(12) **United States Design Patent** (10) **Patent No.:** **US D823,213 S**  
**Snyder** (45) **Date of Patent:** **\*\* Jul. 17, 2018**

(54) **COMPOSITE WHEEL**

(71) Applicant: **EVE WHEELS LLC**, Lenexa, KS (US)

(72) Inventor: **Colin S. Snyder**, Lenexa, KS (US)

(73) Assignee: **Eve Wheels LLC**, Lenexa, KS (US)

(\*\*) Term: **15 Years**

(21) Appl. No.: **29/532,133**

(22) Filed: **Jul. 1, 2015**

(51) **LOC (11) Cl.** ..... **12-16**

(52) **U.S. Cl.**  
USPC ..... **D12/208**

(58) **Field of Classification Search**  
USPC ..... **D12/204–213**

(Continued)

(56) **References Cited**

U.S. PATENT DOCUMENTS

D25,425 S \* 4/1896 Lobdell ..... D12/208  
D173,664 S \* 12/1954 Lyon ..... D12/209

(Continued)

*Primary Examiner* — George D. Kirschbaum

(74) *Attorney, Agent, or Firm* — Kutak Rock LLP; Bryan P. Stanley

(57) **CLAIM**

The ornamental design for a composite wheel, as shown and described.

**DESCRIPTION**

FIG. 1 is an exploded front perspective view of a composite wheel of the instant invention, including a wheel center, the wheel being formed from composite material positioned and oriented in a vertical pattern on the front face of the wheel. The broken line showing of a wheel center is included for the purpose of illustrating one of many potential wheel

centers that can be used with the composite wheel and forms no part of the claimed design.

FIG. 2 is a front elevation view of the wheel of FIG. 1.

FIG. 3 is a right side elevation view of the wheel of FIG. 1, it being understood that all other side, top and bottom views are substantially mirror images of the same.

FIG. 4 is a rear elevation view of the wheel of FIG. 1.

FIG. 5 is a detailed partial view of FIG. 2, shown in an enlarged scale so as to more clearly show the vertical pattern on the front of the wheel of FIG. 1.

FIG. 6 is a front perspective view of the wheel of the instant invention, the wheel being formed from composite material positioned and oriented in a horizontal pattern on the front face of the wheel.

FIG. 7 is a front elevation view of the wheel of FIG. 6.

FIG. 8 is a detailed partial view of FIG. 7, shown in an enlarged scale so as to more clearly show the horizontal pattern on the front of the wheel of FIG. 6.

FIG. 9 is a front perspective view of the wheel of the instant invention, the wheel being formed from composite material positioned and oriented in a horizontal pattern on the front face of the wheel of FIG. 6.

FIG. 10 is a front elevation view of the wheel of FIG. 9.

FIG. 11 is a detailed partial view of FIG. 10, shown in an enlarged scale so as to more clearly show the horizontal pattern on the front face of the wheel of FIG. 9.

FIG. 12 is a front perspective view of the wheel of the instant invention, the wheel being formed from composite material positioned and oriented in a horizontal pattern on the front face of the wheel.

FIG. 13 is a front elevation view of the wheel of FIG. 12.

FIG. 14 is a detailed partial view of FIG. 13, shown in an enlarged scale so as to more clearly show the horizontal pattern on the front face of the wheel of FIG. 12.

FIG. 15 is a front perspective view of the wheel of the instant invention, the wheel being formed from composite material positioned and oriented in a vertical pattern on the front face of the wheel.

FIG. 16 is a front elevation view of the wheel of FIG. 15.

FIG. 17 is a detailed partial view of FIG. 16, shown in an enlarged scale so as to more clearly show the vertical pattern on the front face of the wheel of FIG. 15.

(Continued)

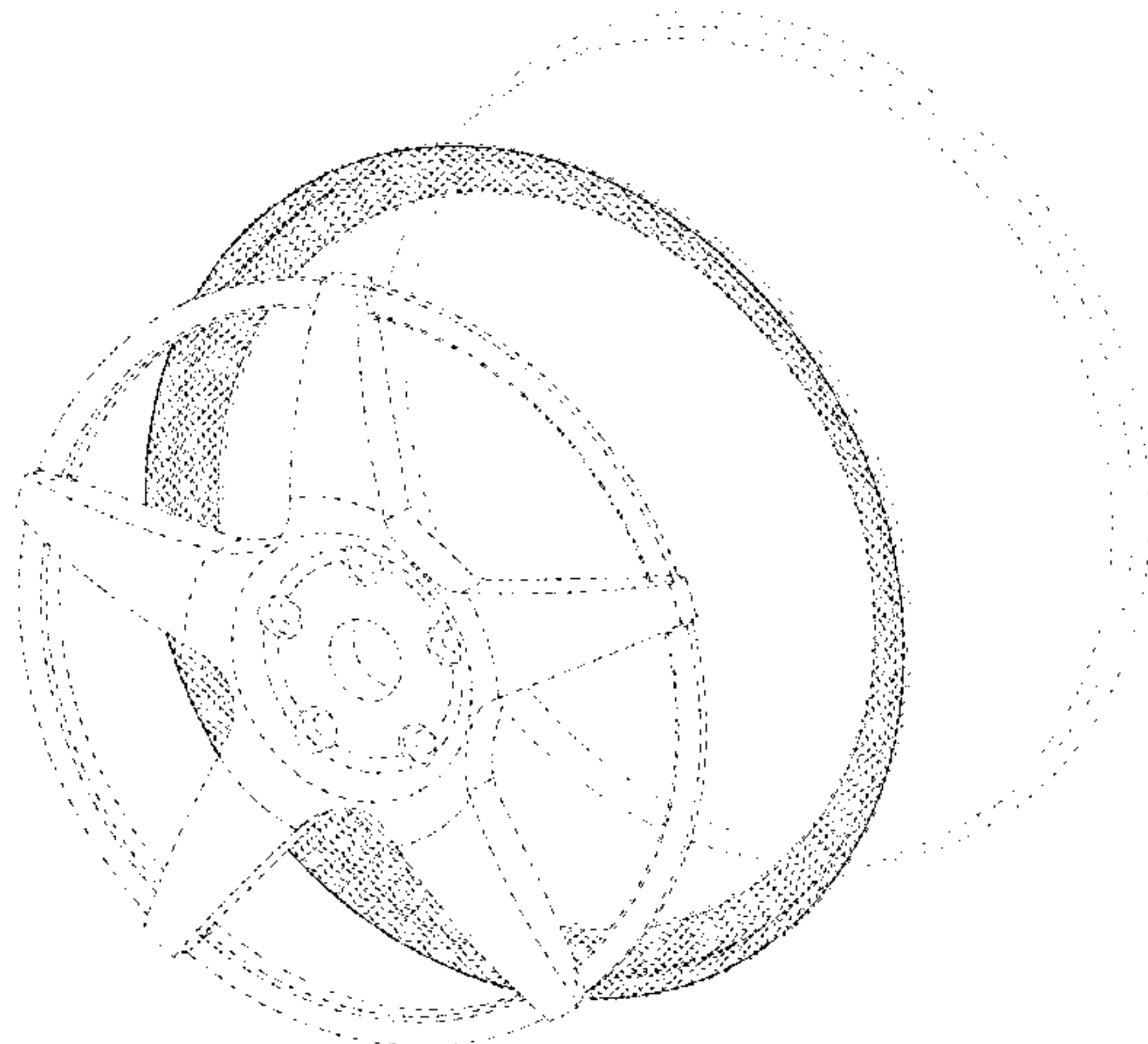

FIG. 18 is a front perspective view of the wheel of the instant invention, the wheel being formed from composite material positioned and oriented in a vertical pattern on the front face of the wheel.

FIG. 19 is a front elevation view of the wheel of FIG. 18.

FIG. 20 is a detailed partial view of FIG. 19, shown in an enlarged scale so as to more clearly show the vertical pattern on the front face of the wheel of FIG. 18.

FIG. 21 is a front perspective view of the wheel of the instant invention, the wheel being formed from composite material positioned and oriented in a vertical pattern on the front face of the wheel.

FIG. 22 is a front elevation view of the wheel of FIG. 21.

FIG. 23 is a detailed partial view of FIG. 22, shown in an enlarged scale so as to more clearly show the vertical pattern on the front face of the wheel of FIG. 21.

FIG. 24 is a front perspective view of the wheel of the instant invention, the wheel being formed from composite material positioned and oriented in a vertical pattern on the front face of the wheel.

FIG. 25 is a front elevation view of the wheel of FIG. 24.

FIG. 26 is a detailed partial view of FIG. 25, shown in an enlarged scale so as to more clearly show the vertical pattern on the front face of the wheel of FIG. 24.

FIG. 27 is a front perspective view of the wheel of the instant invention, the wheel being formed from composite material positioned and oriented in a vertical pattern on the front face of the wheel.

FIG. 28 is a front elevation view of the wheel of FIG. 27.

FIG. 29 is a detailed partial view of FIG. 28, shown in an enlarged scale so as to more clearly show the vertical pattern on the front face of the wheel of FIG. 27.

FIG. 30 is a front perspective view of the wheel of the instant invention, the wheel being formed from composite material positioned and oriented in a vertical pattern on the front face of the wheel.

FIG. 31 is a front elevation view of the wheel of FIG. 30; and,

FIG. 32 is a detailed partial view of FIG. 31, shown in an enlarged scale so as to more clearly show the vertical pattern on the front face of the wheel of FIG. 30.

The broken line showing of portions of the wheel are included for the purpose of illustrating elements of the wheel that form no art of the claimed design. The dash dot dash lines define the bounds of the claimed design and form no part thereof.

**1 Claim, 32 Drawing Sheets**

(58) **Field of Classification Search**

CPC .... B60B 7/00; B60B 7/02; B60B 7/04; B60B 7/01; B60B 7/06; B60B 3/02; B60B 3/04; B60B 3/06; B60B 3/10; B60B 1/00; B60B 1/08; B60B 1/10; B60B 1/12

See application file for complete search history.

(56) **References Cited**

U.S. PATENT DOCUMENTS

D398,894	S	*	9/1998	Kelley	.....	D12/208
D415,089	S	*	10/1999	Schardt	.....	D12/208
D433,369	S	*	11/2000	Chung	.....	D12/208
D438,153	S	*	2/2001	Schardt	.....	D12/208
D438,499	S	*	3/2001	Schardt	.....	D12/208
D438,830	S	*	3/2001	Schardt	.....	D12/208
D508,005	S	*	8/2005	Ikeda	.....	D12/208
D513,486	S	*	1/2006	Rivera	.....	D12/208

\* cited by examiner



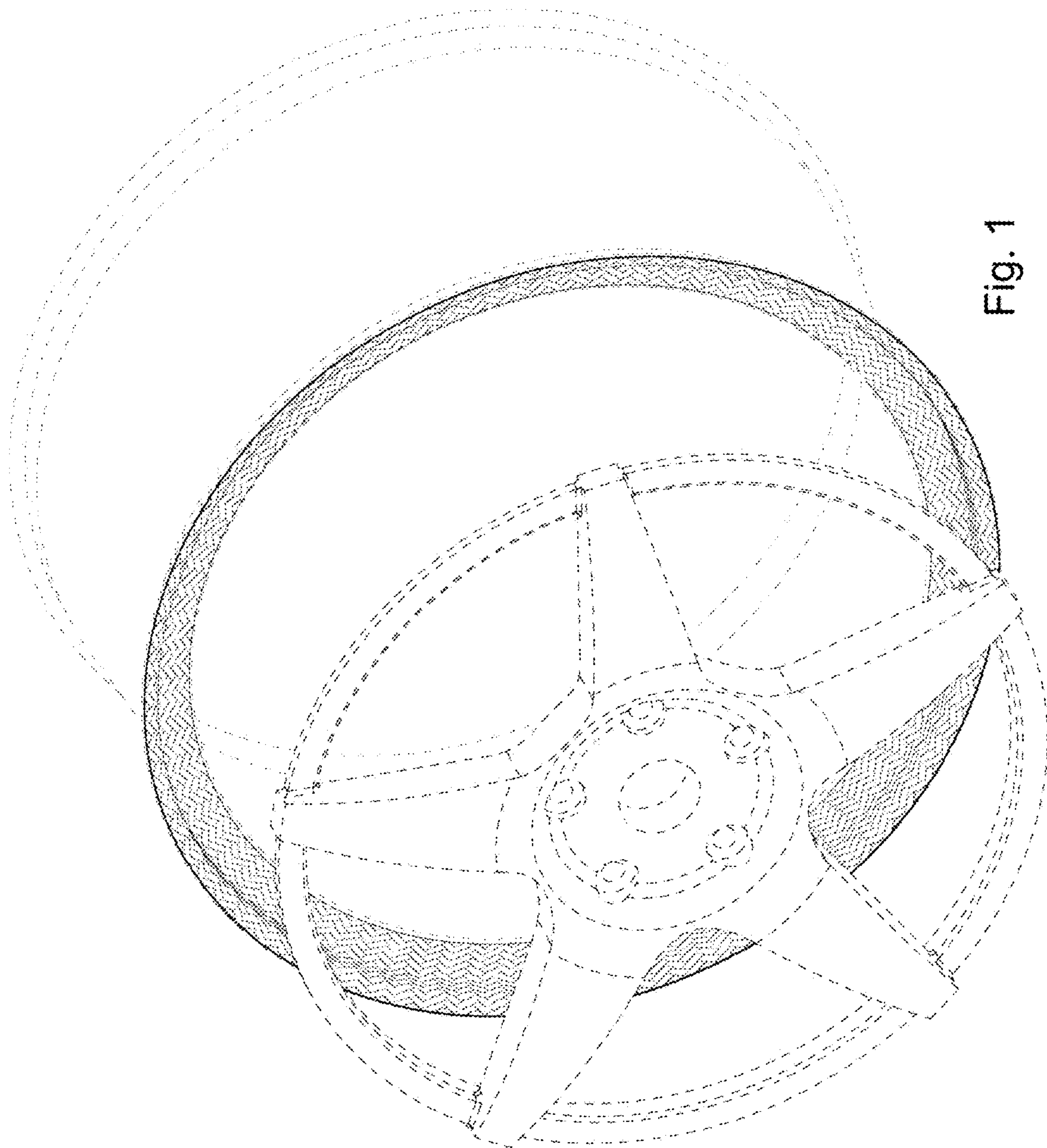
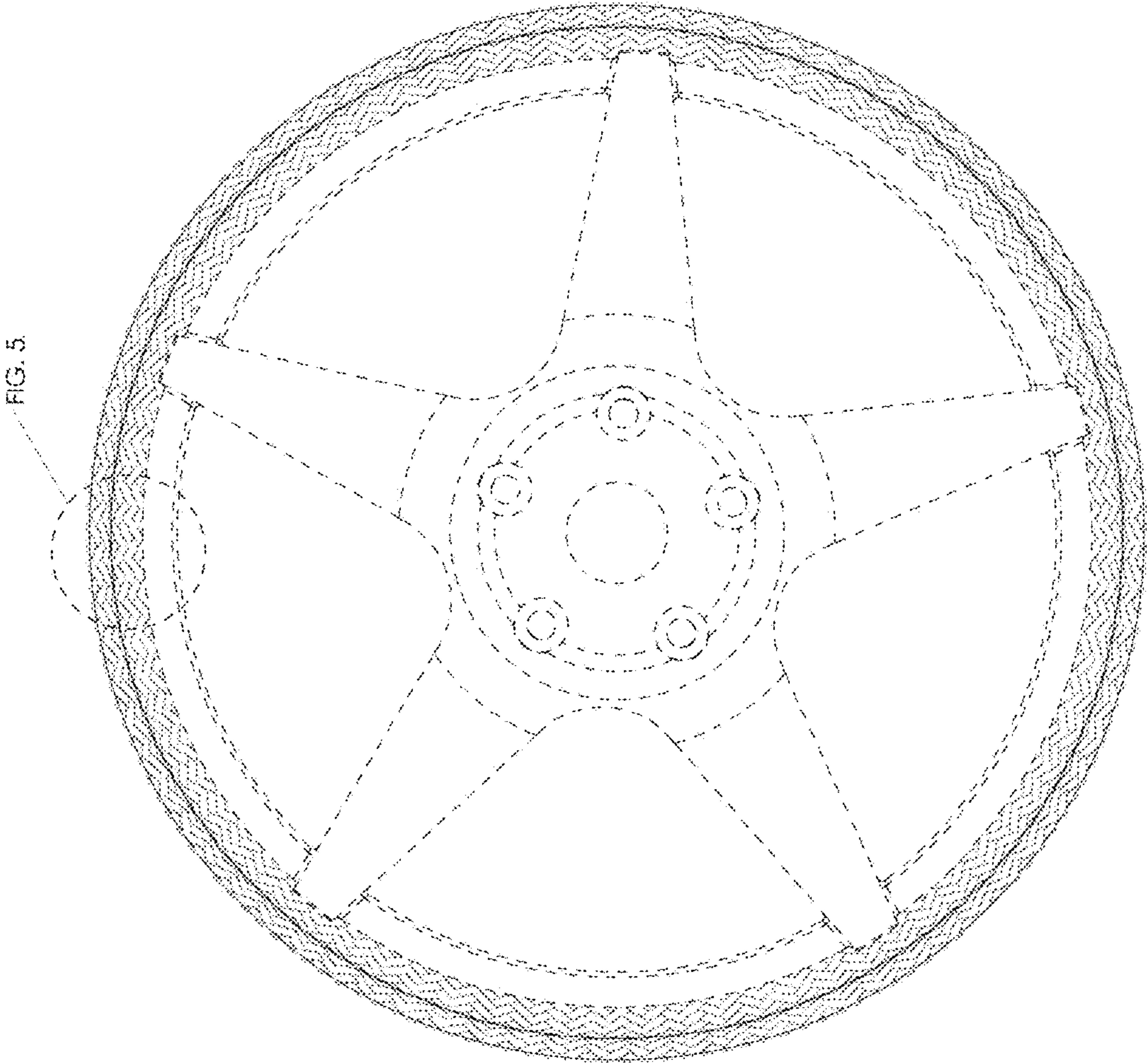

Fig. 1



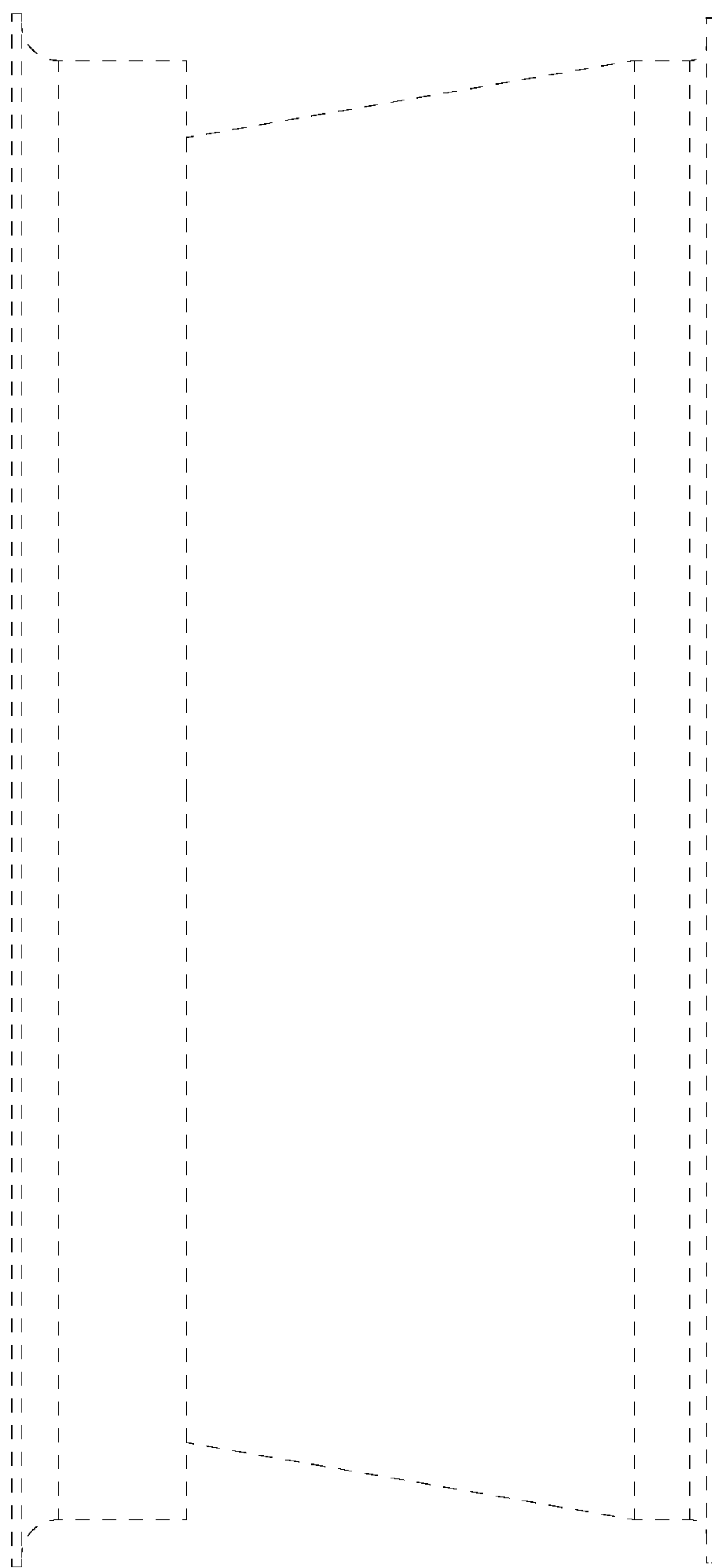

Figure 3

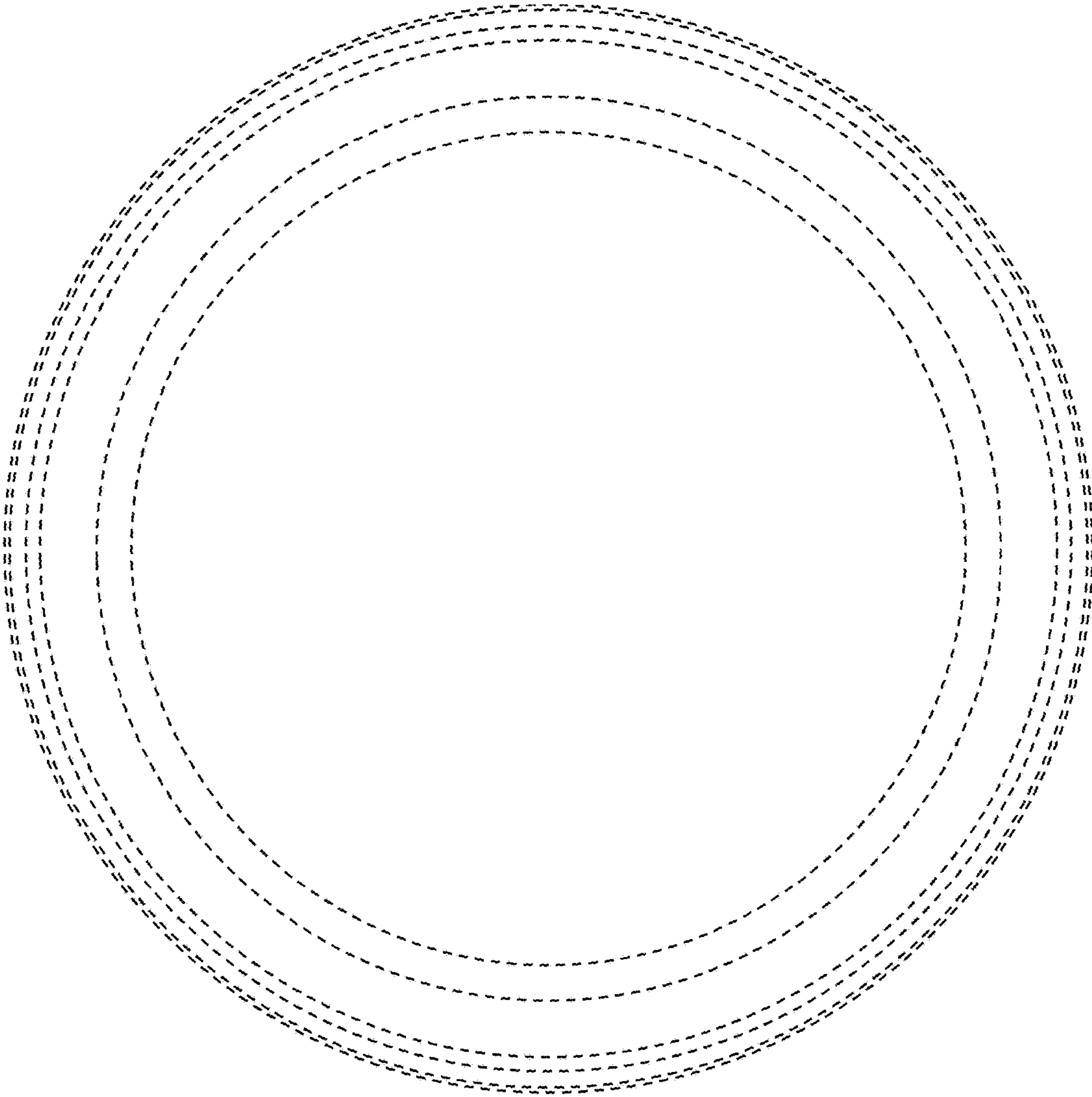

Figure 4

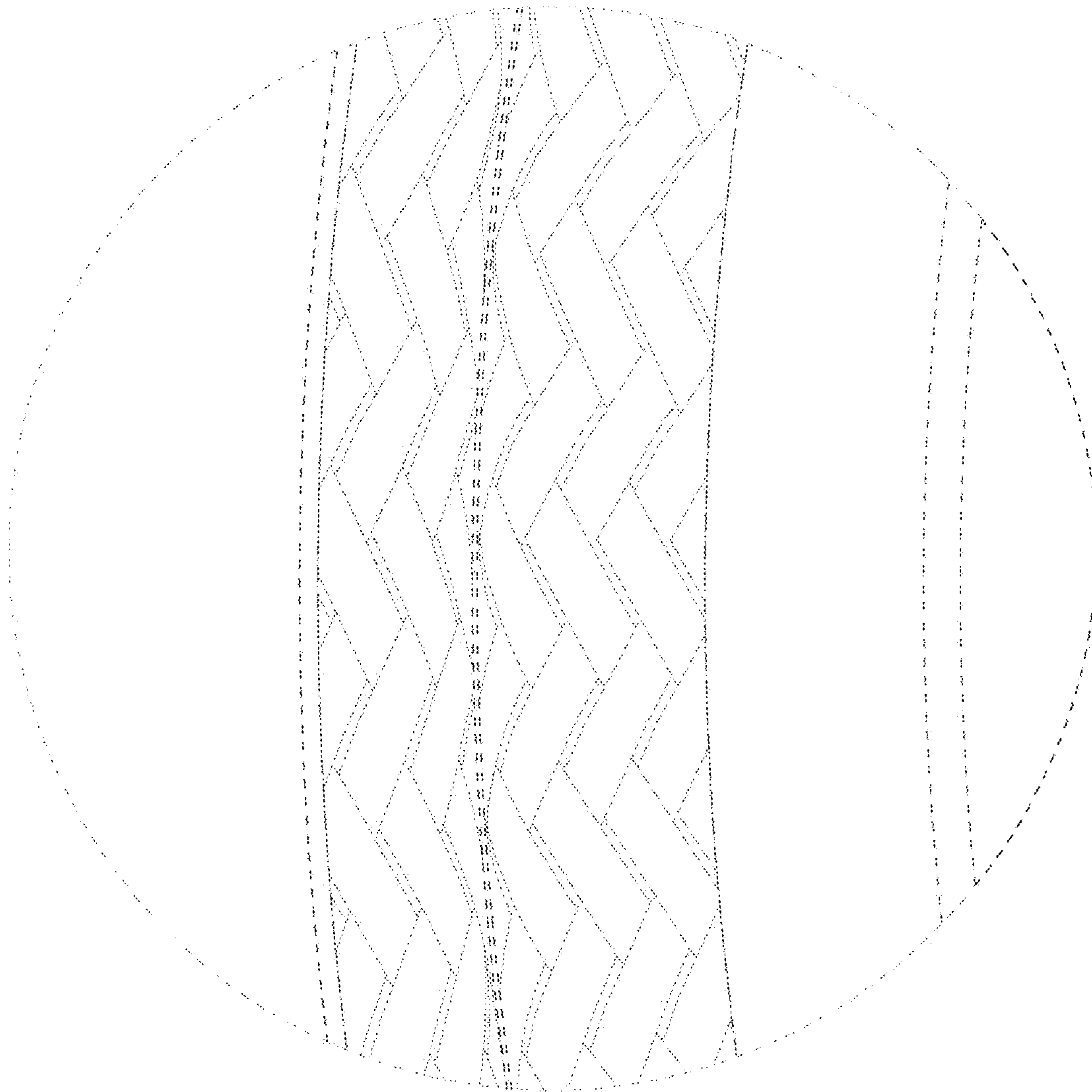

Fig. 5



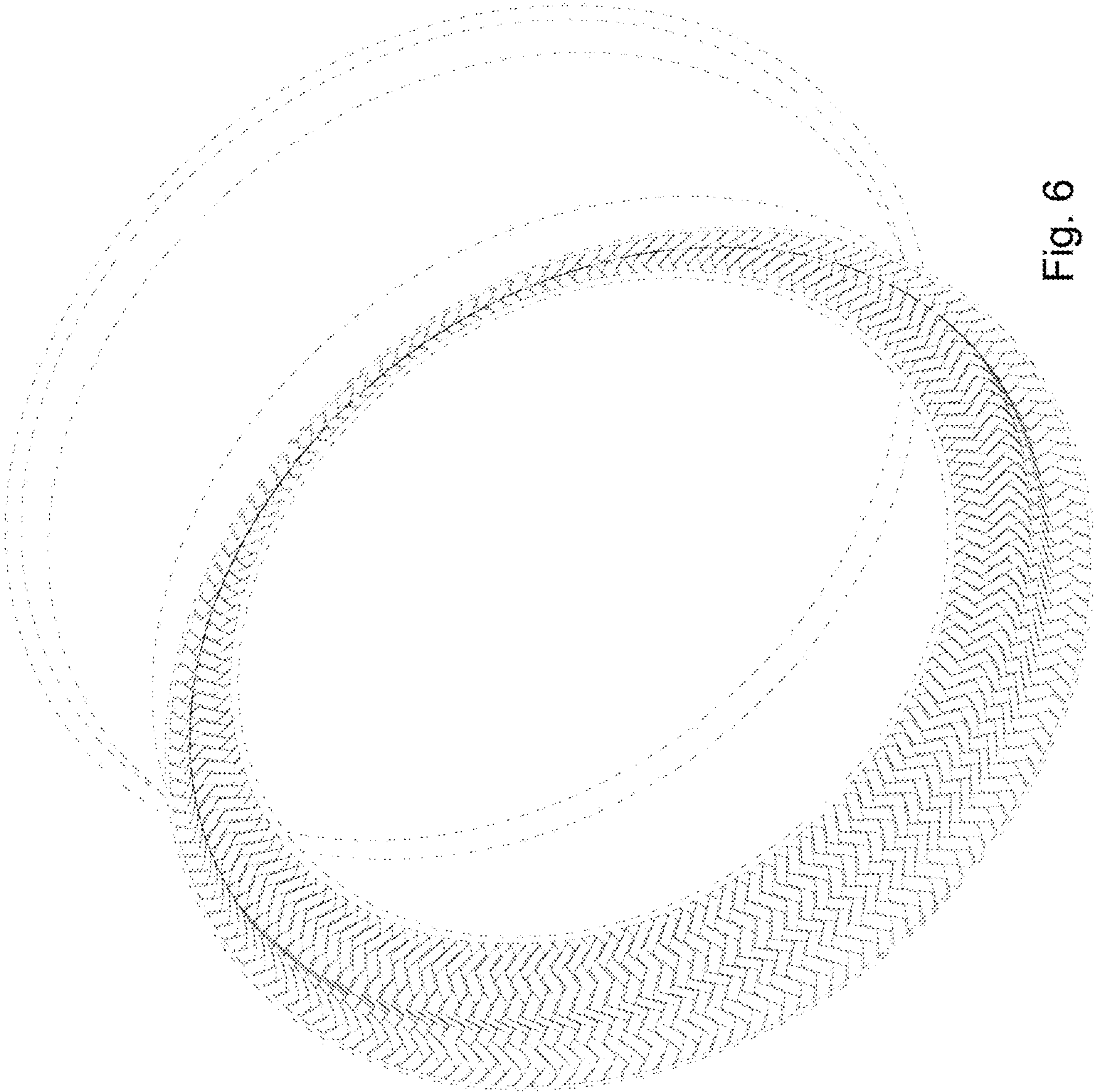

Fig. 6



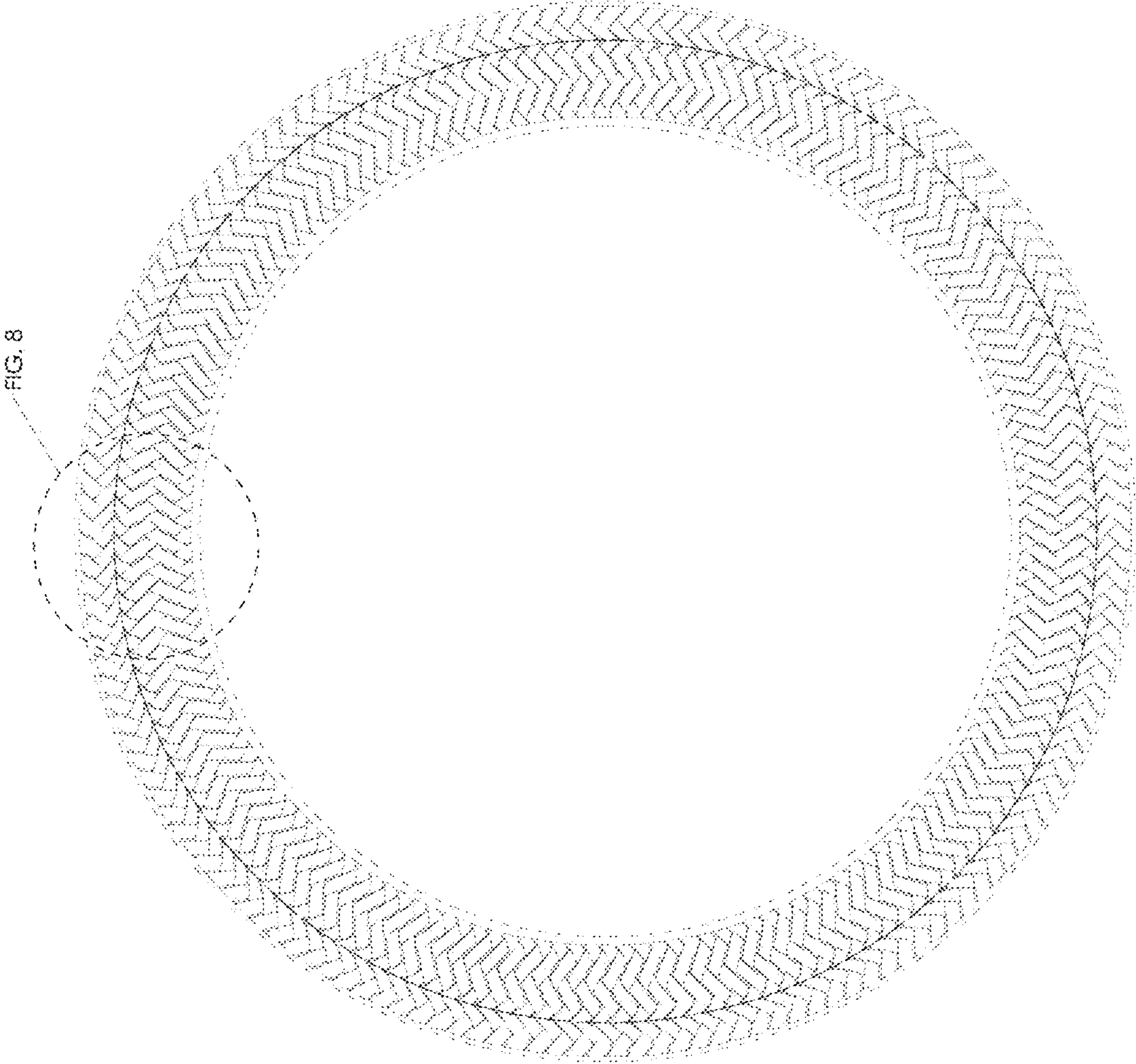

FIG. 8

Fig. 7

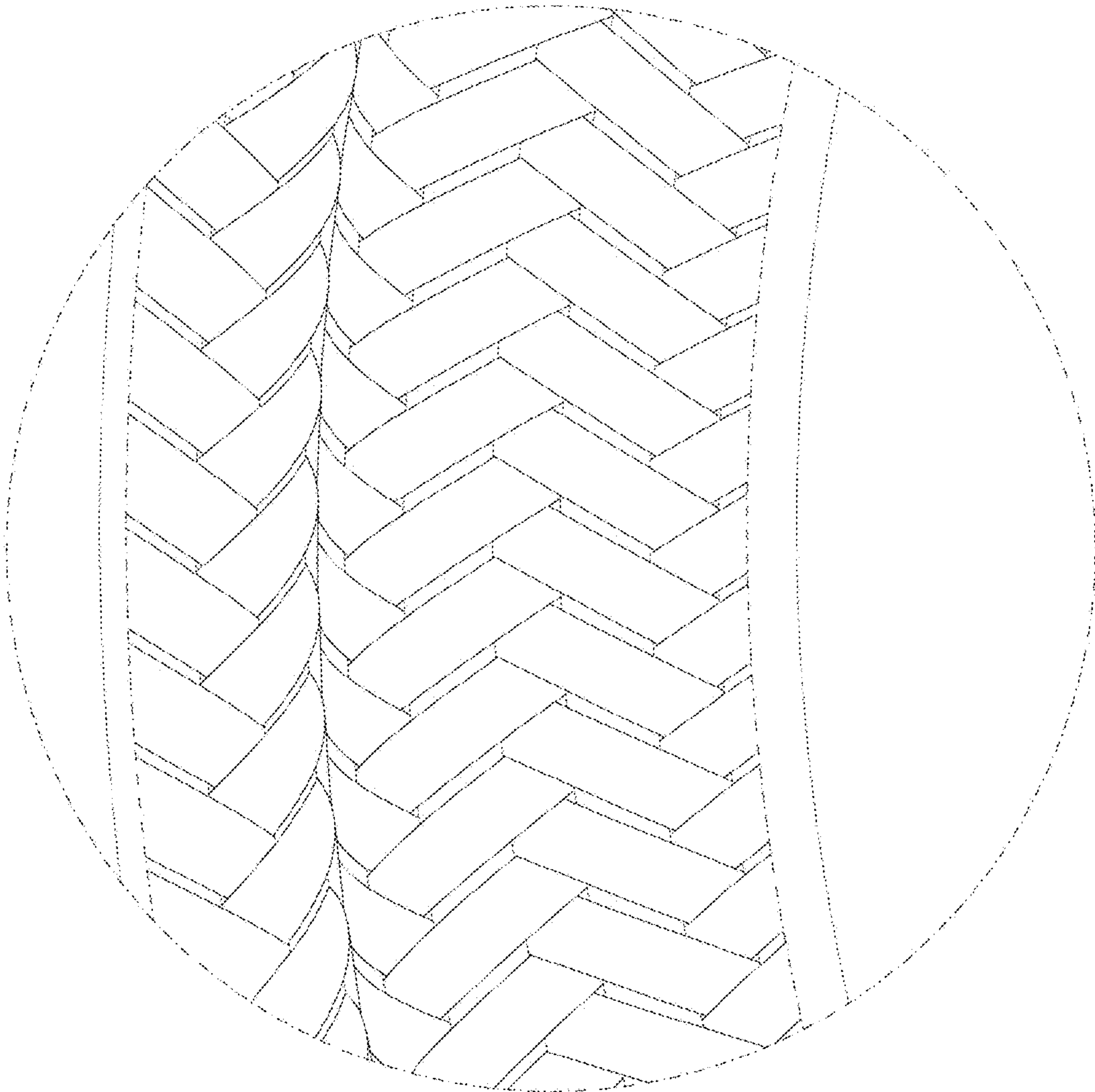

Fig. 8

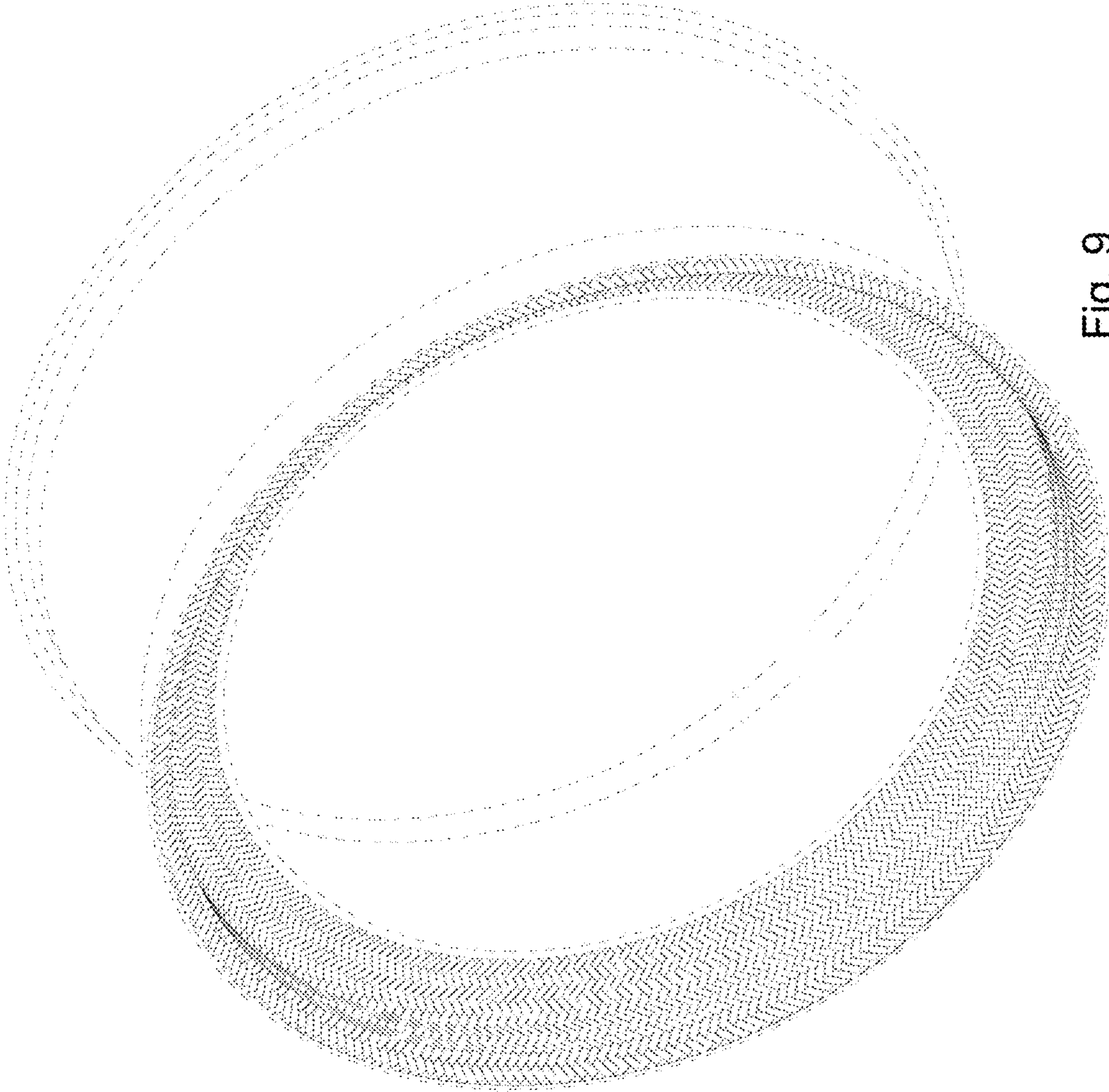

Fig. 9



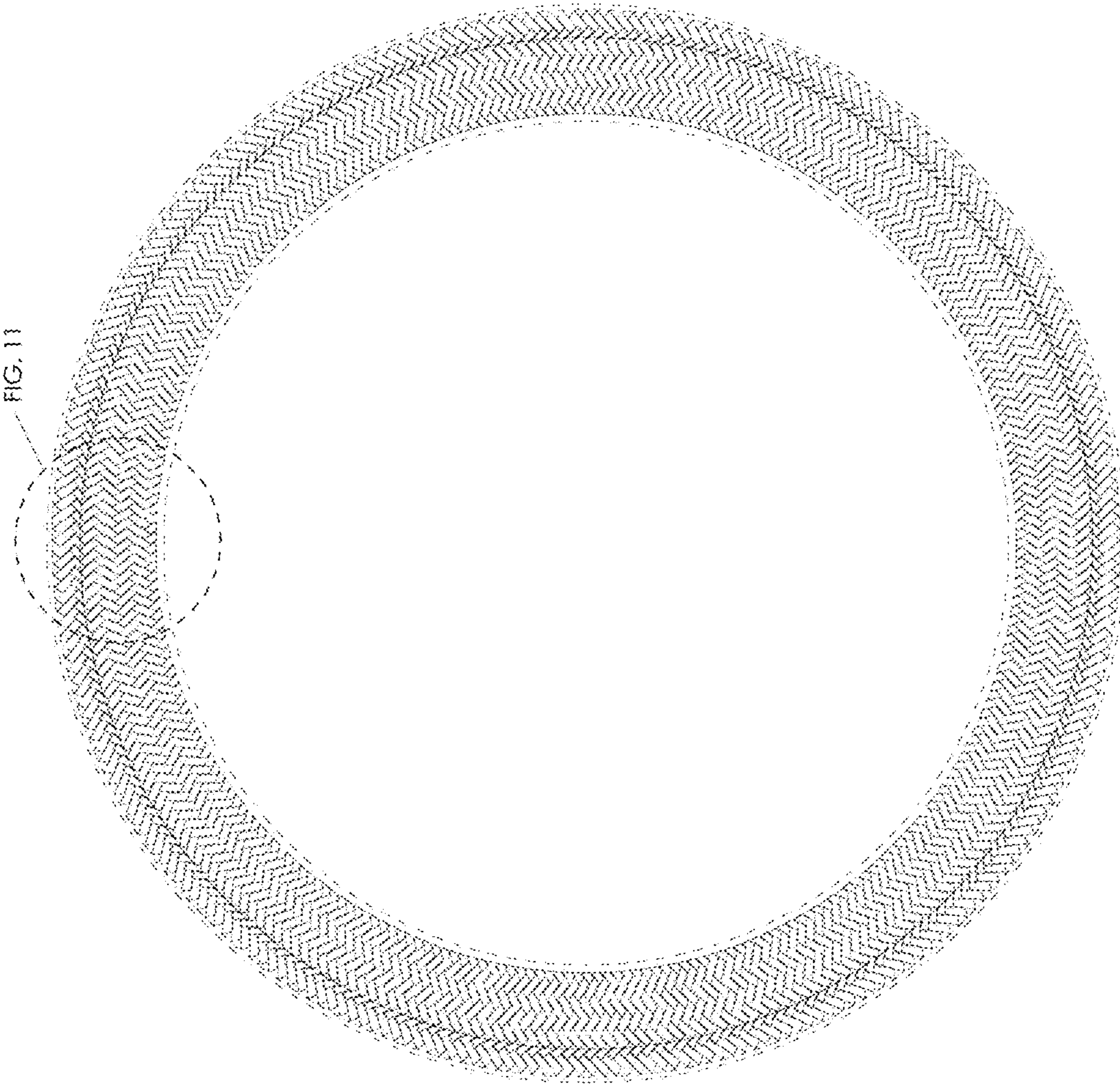

FIG. 11

Fig. 10



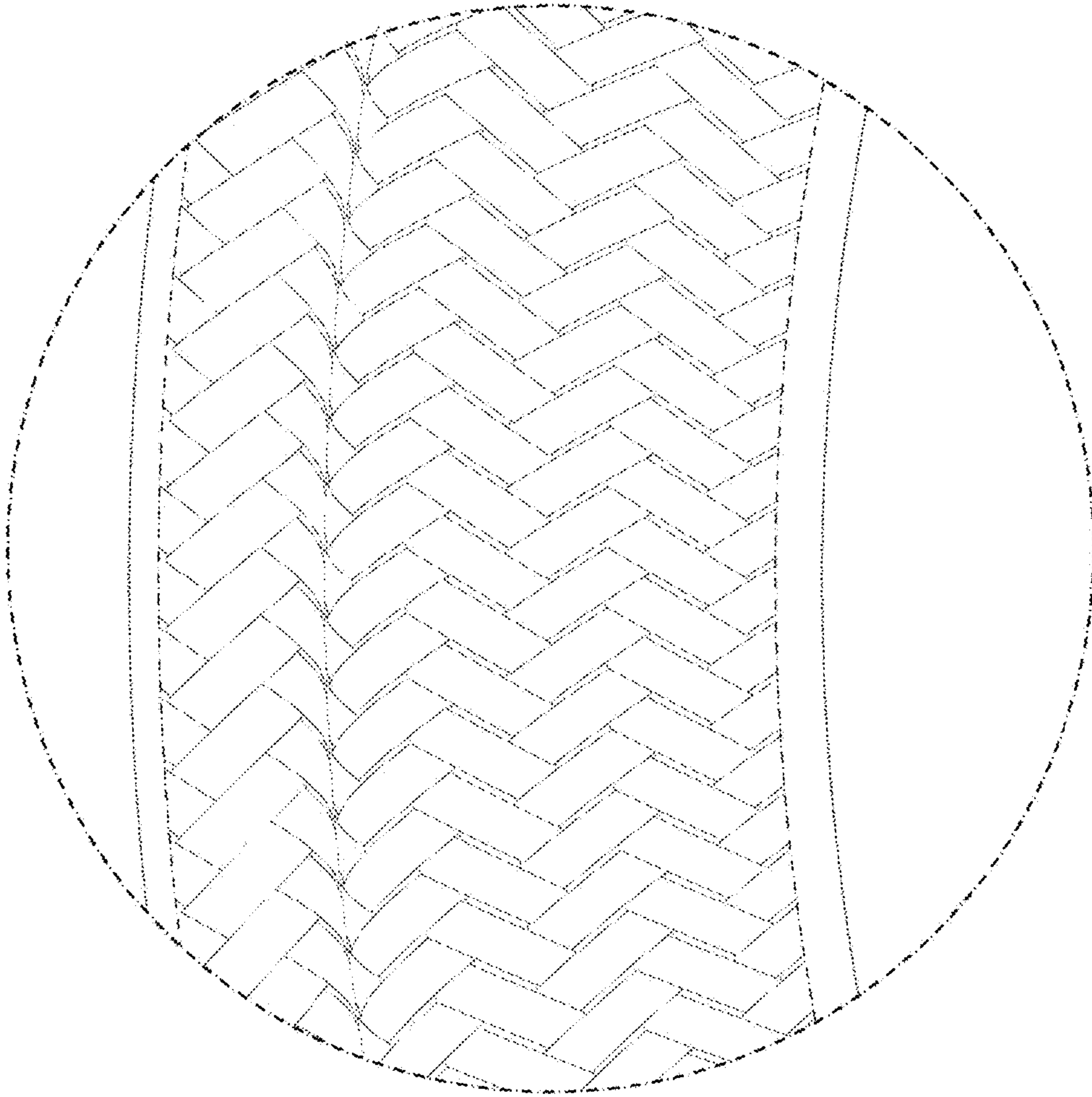

Fig. 11

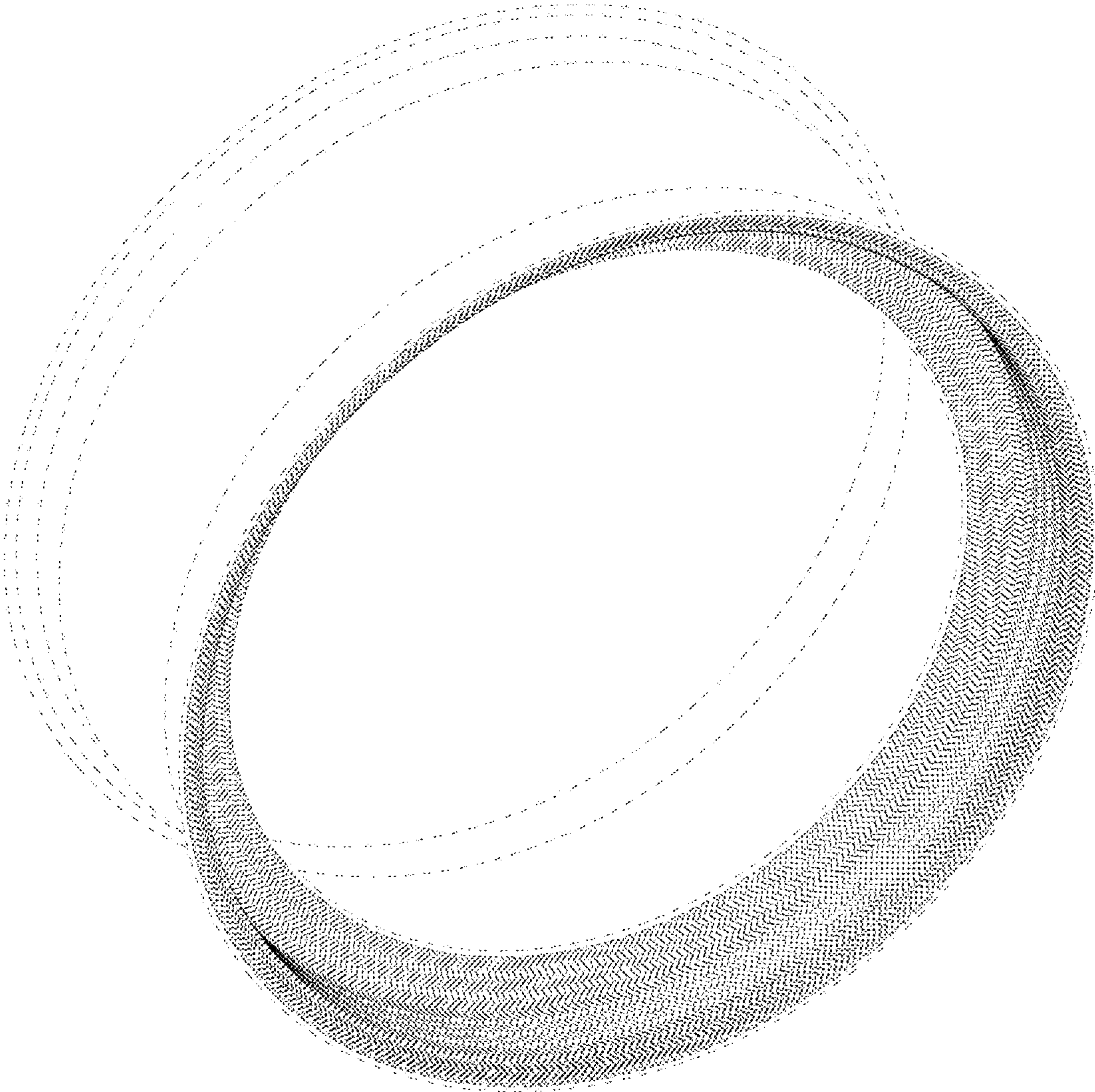

Fig. 12



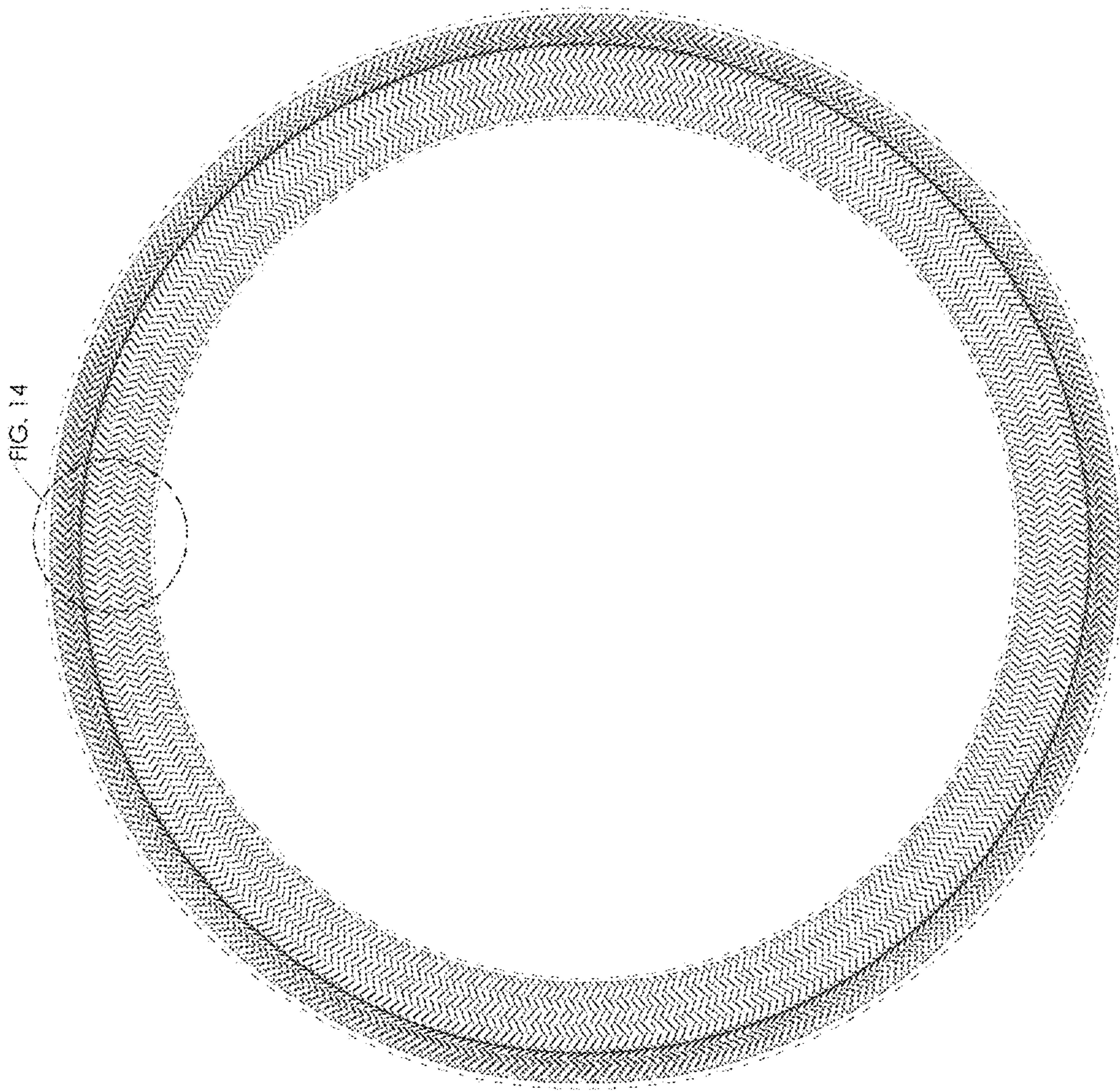

FIG. 14

Fig. 13

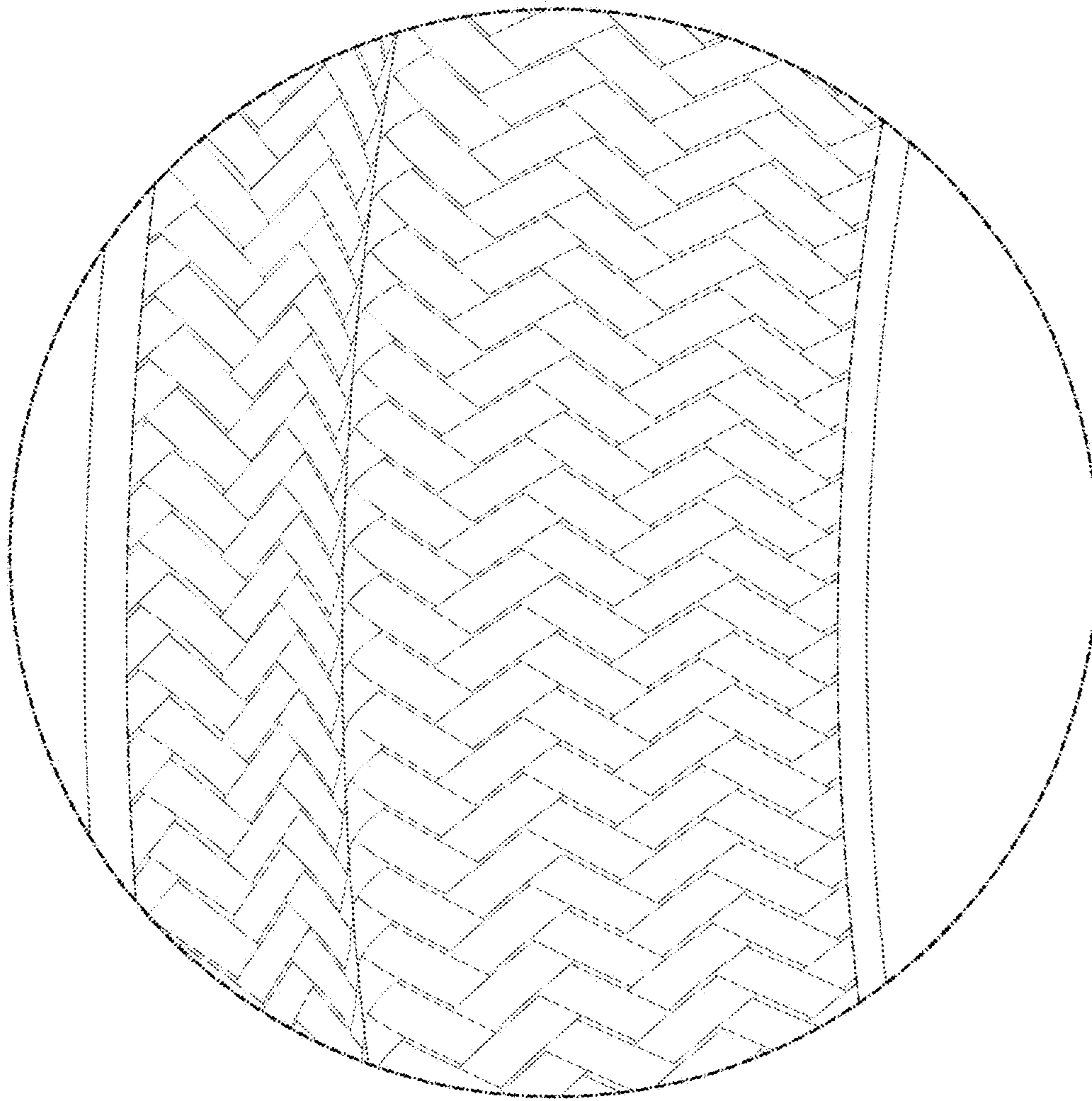

Fig. 14



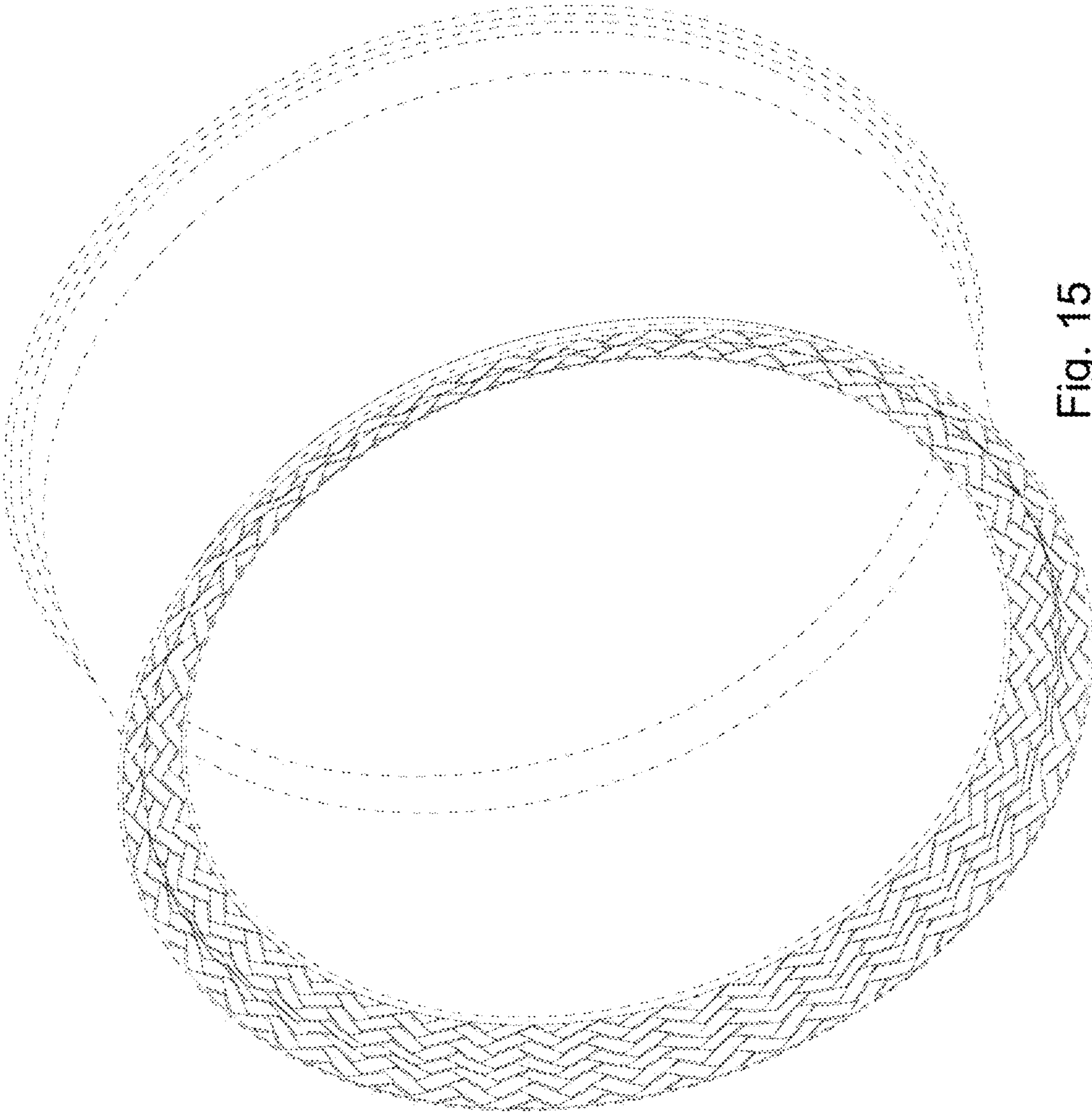

Fig. 15

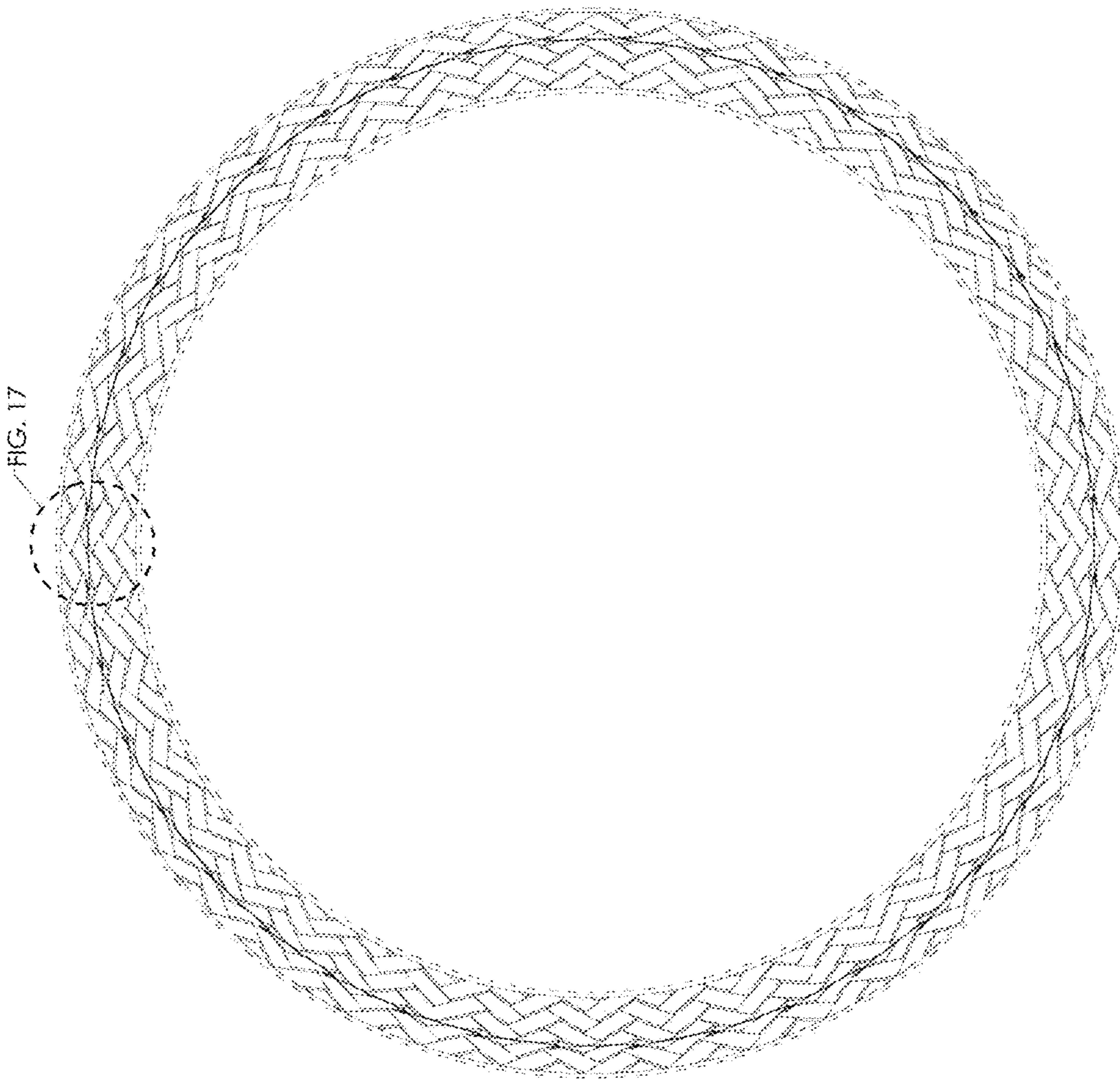

Fig. 16

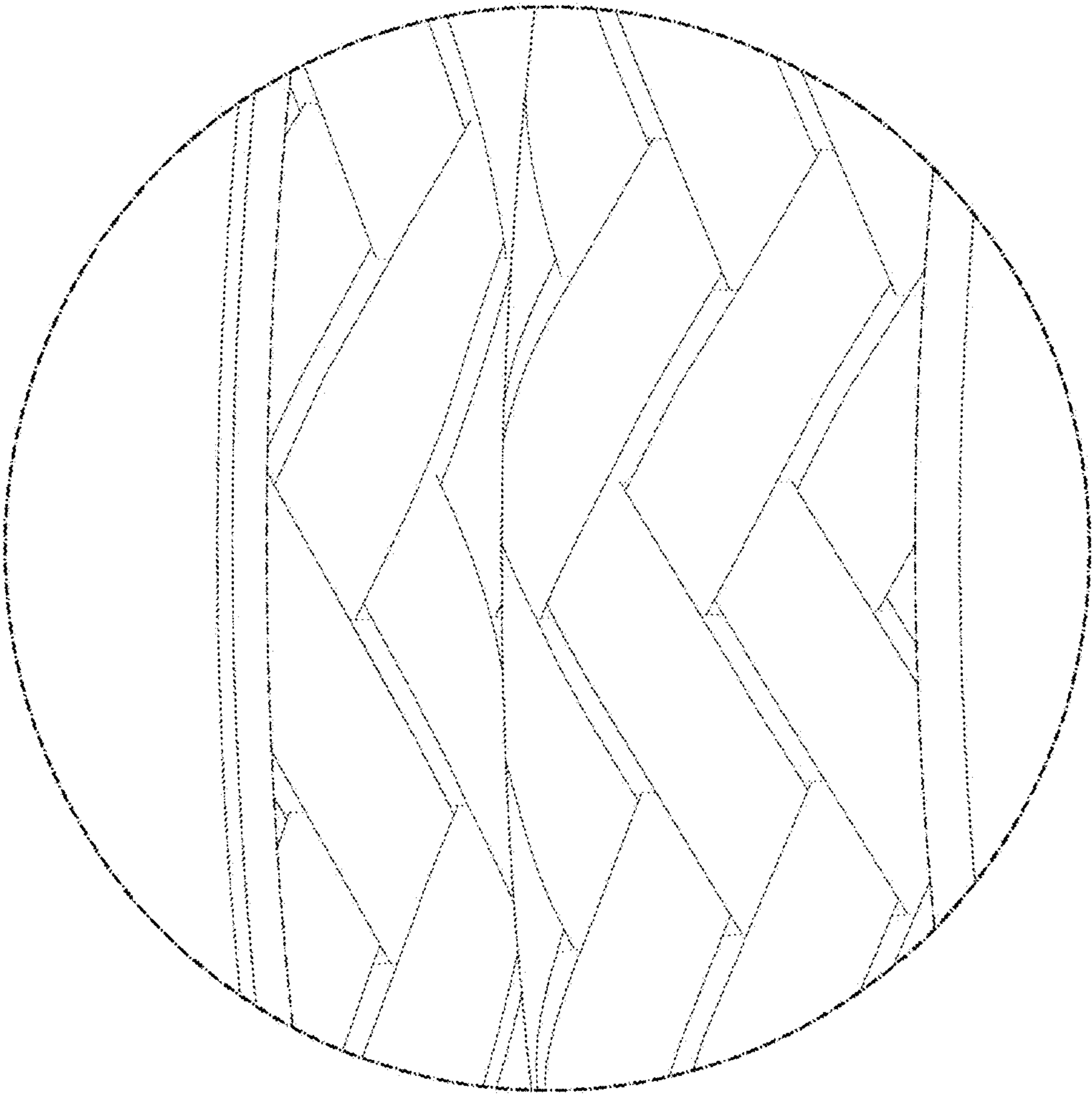

Fig. 17

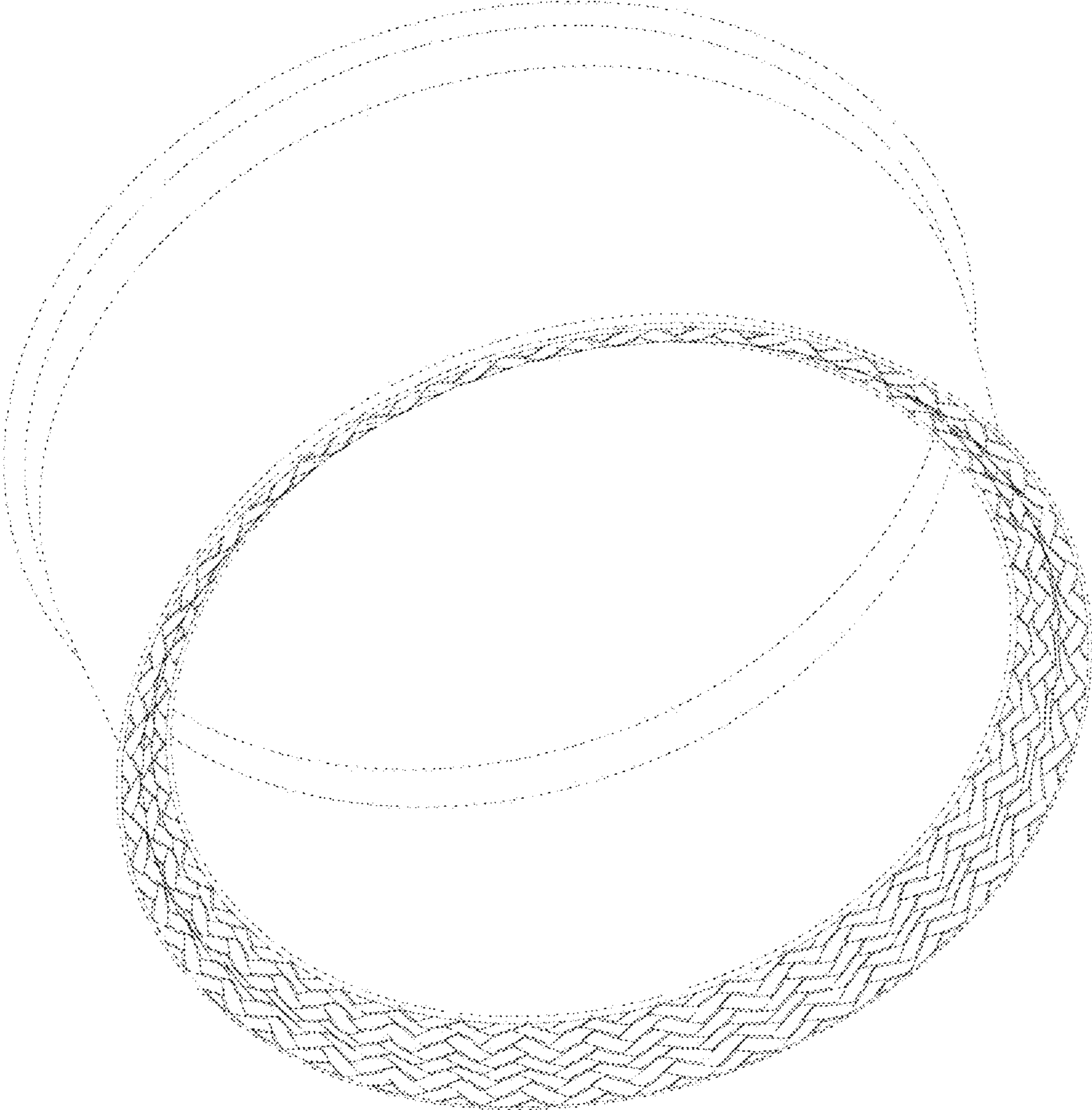

Fig. 18



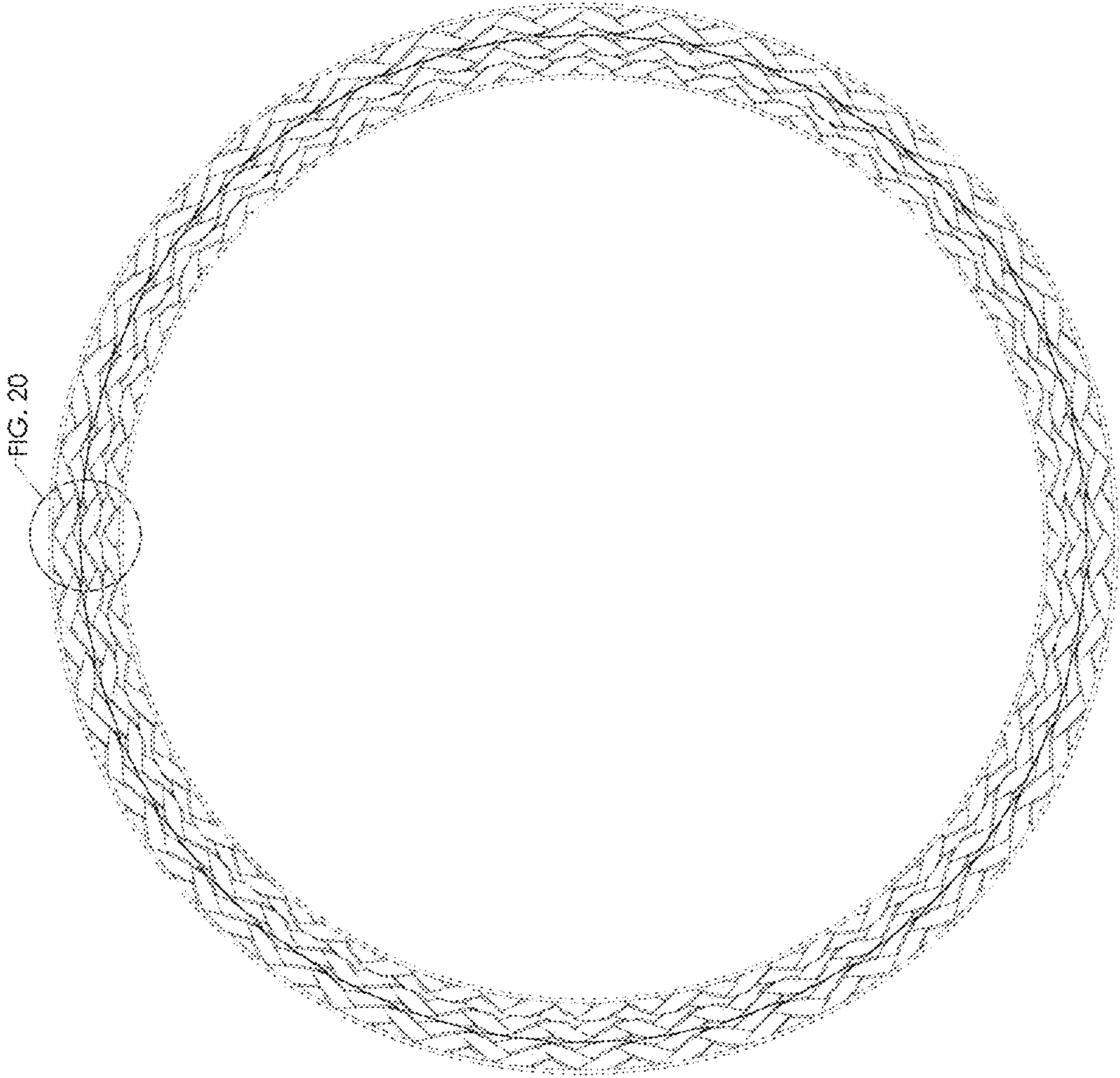

FIG. 20

Fig. 19

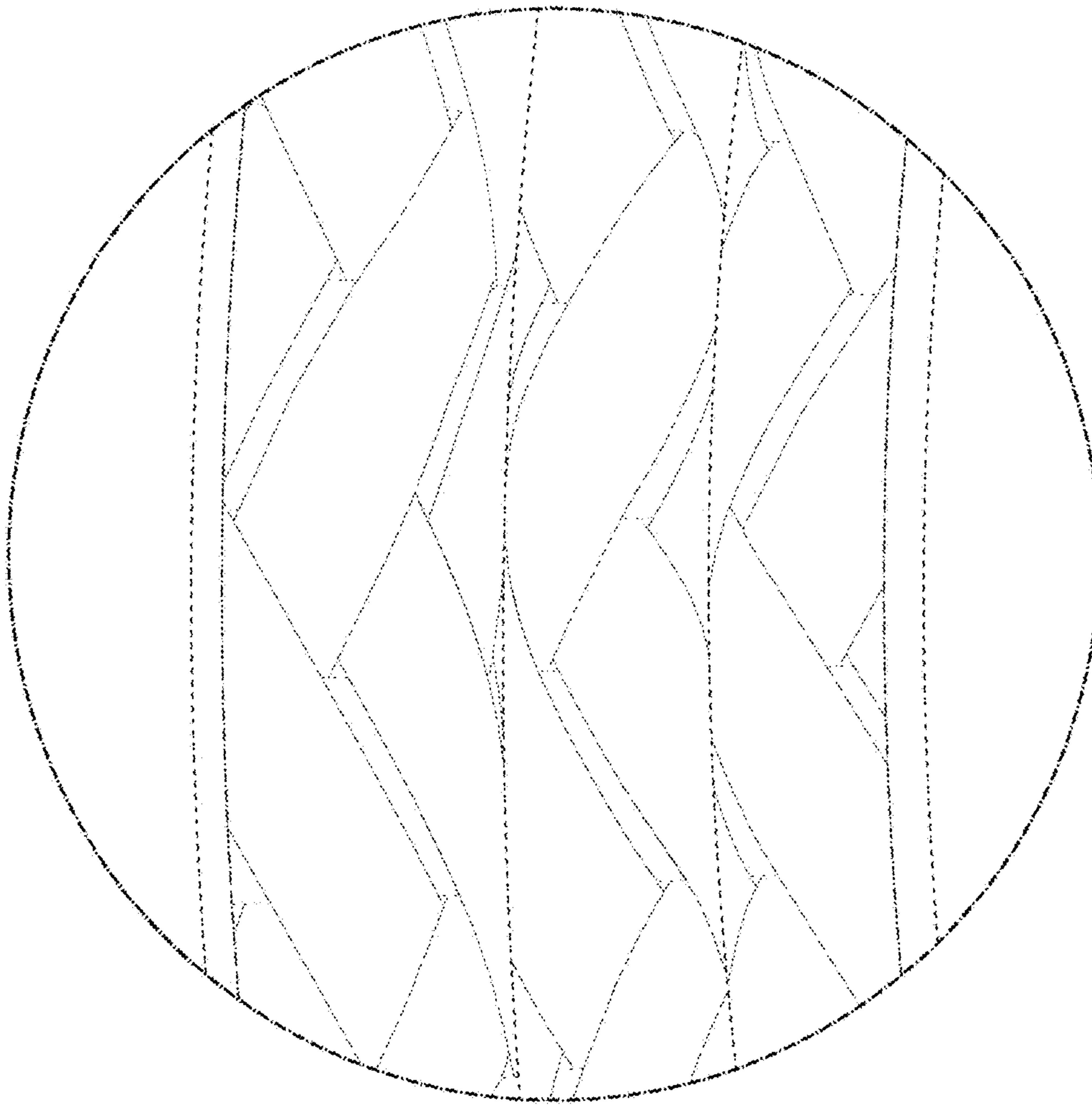

Fig. 20

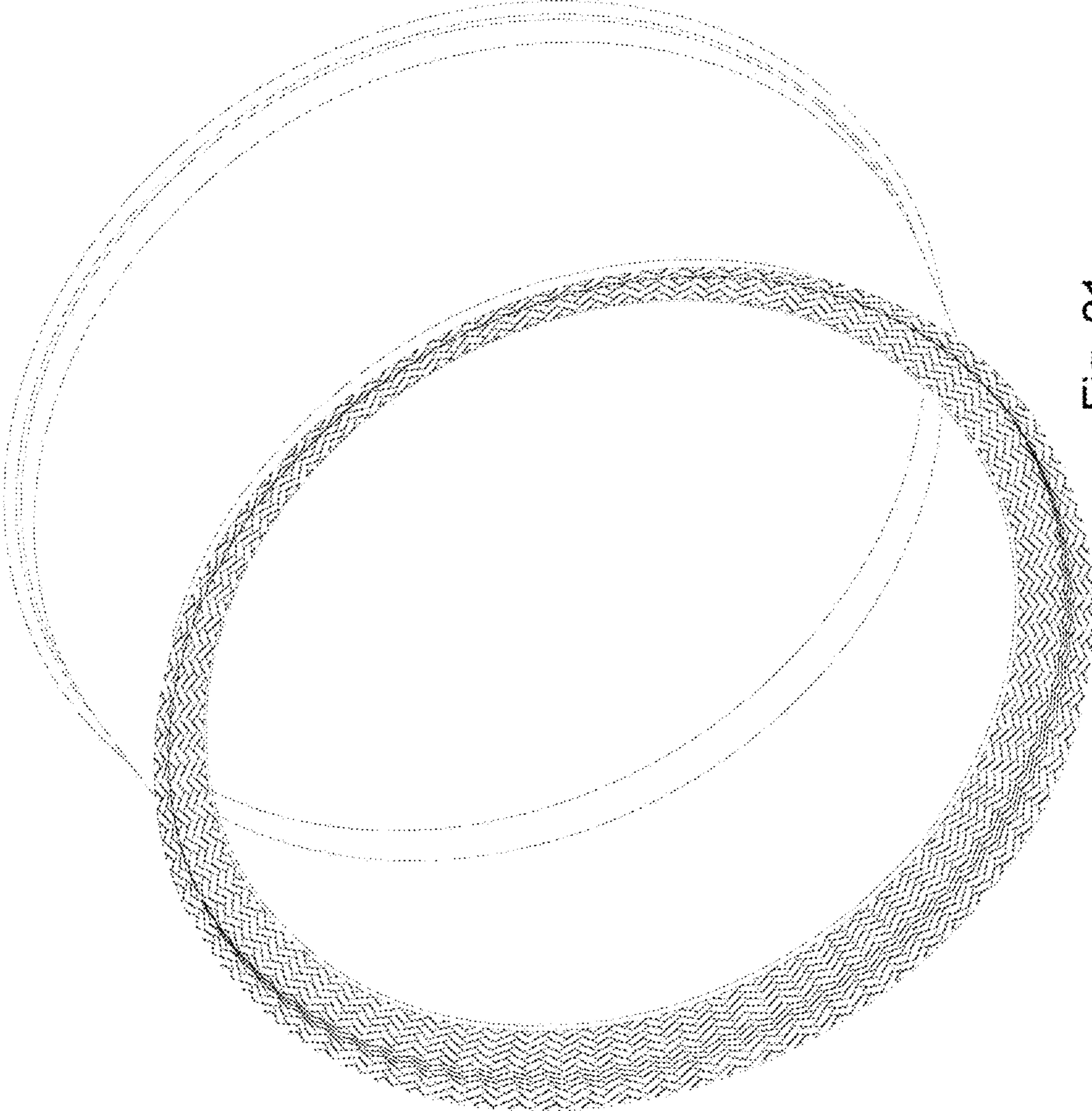

Fig. 21

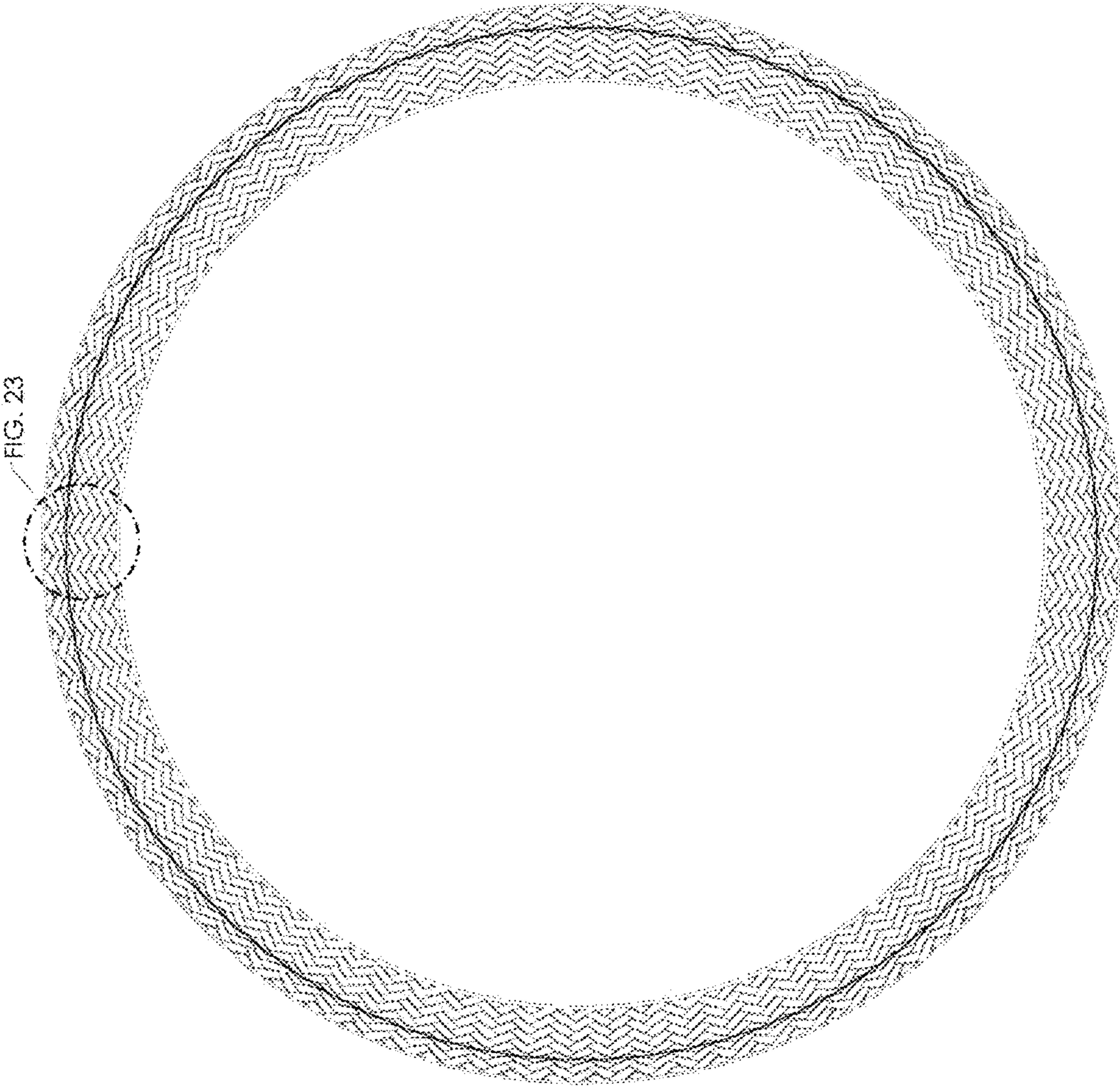

FIG. 23

Fig. 22



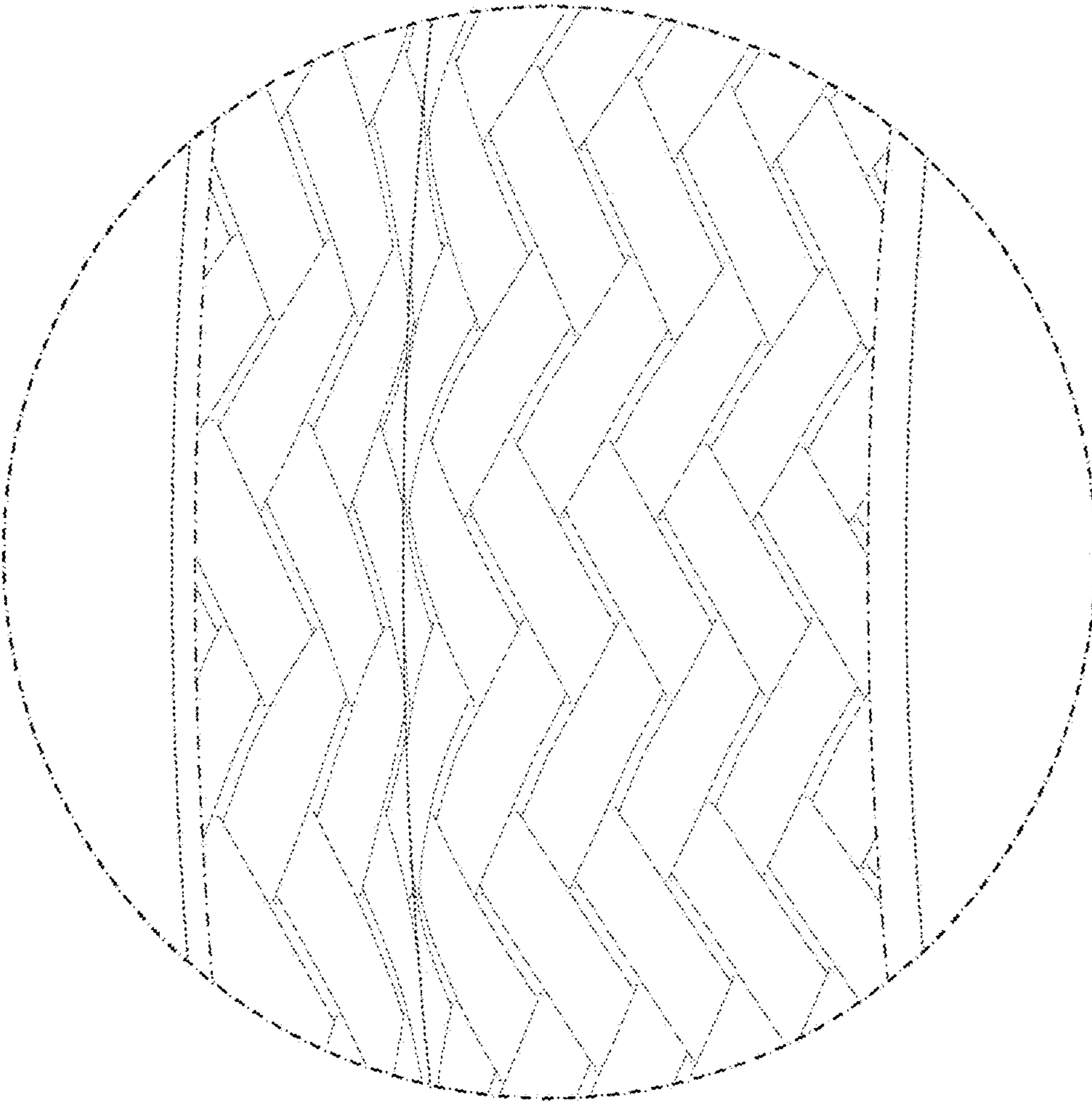

Fig. 23

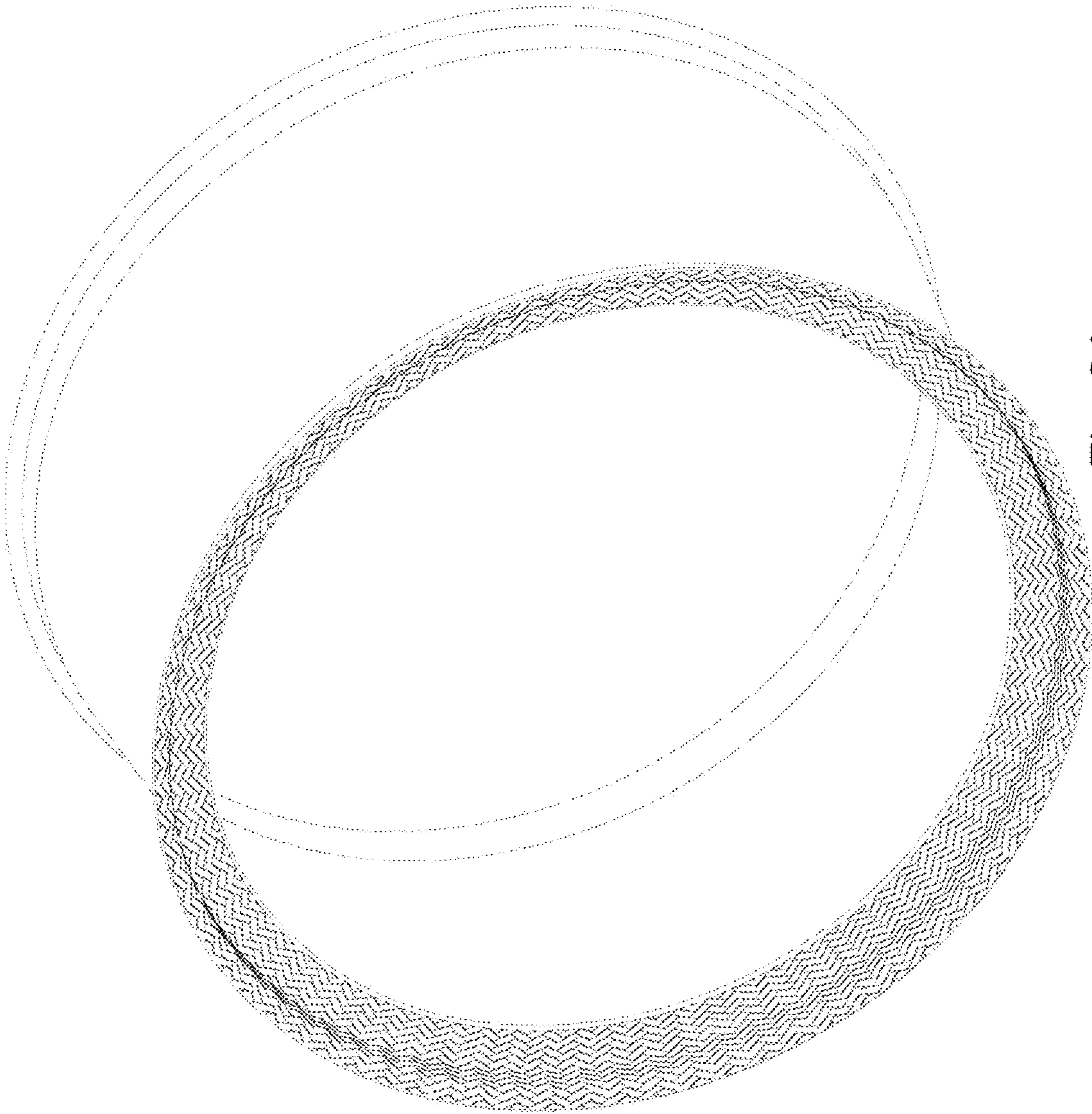

Fig. 24

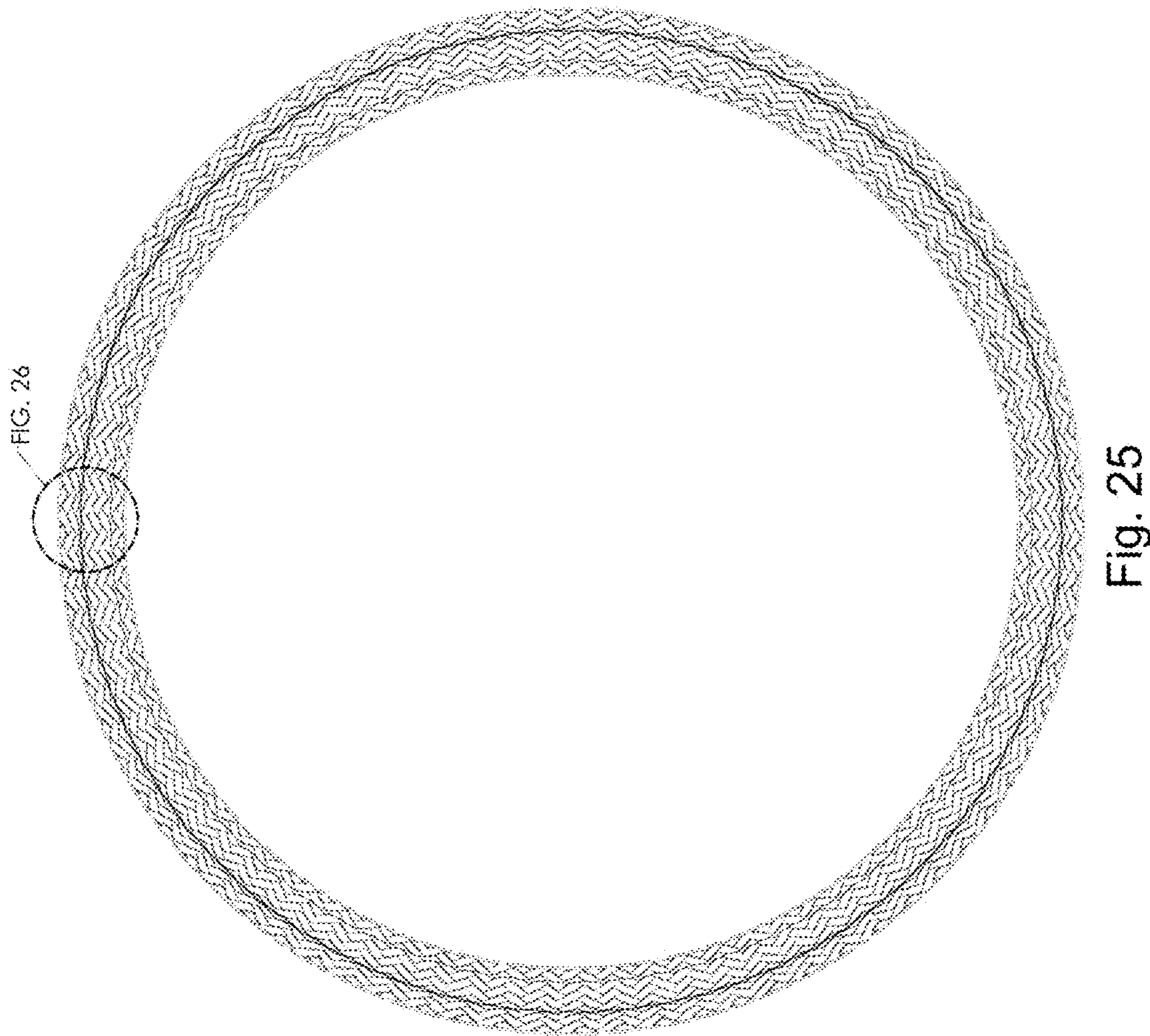

Fig. 25

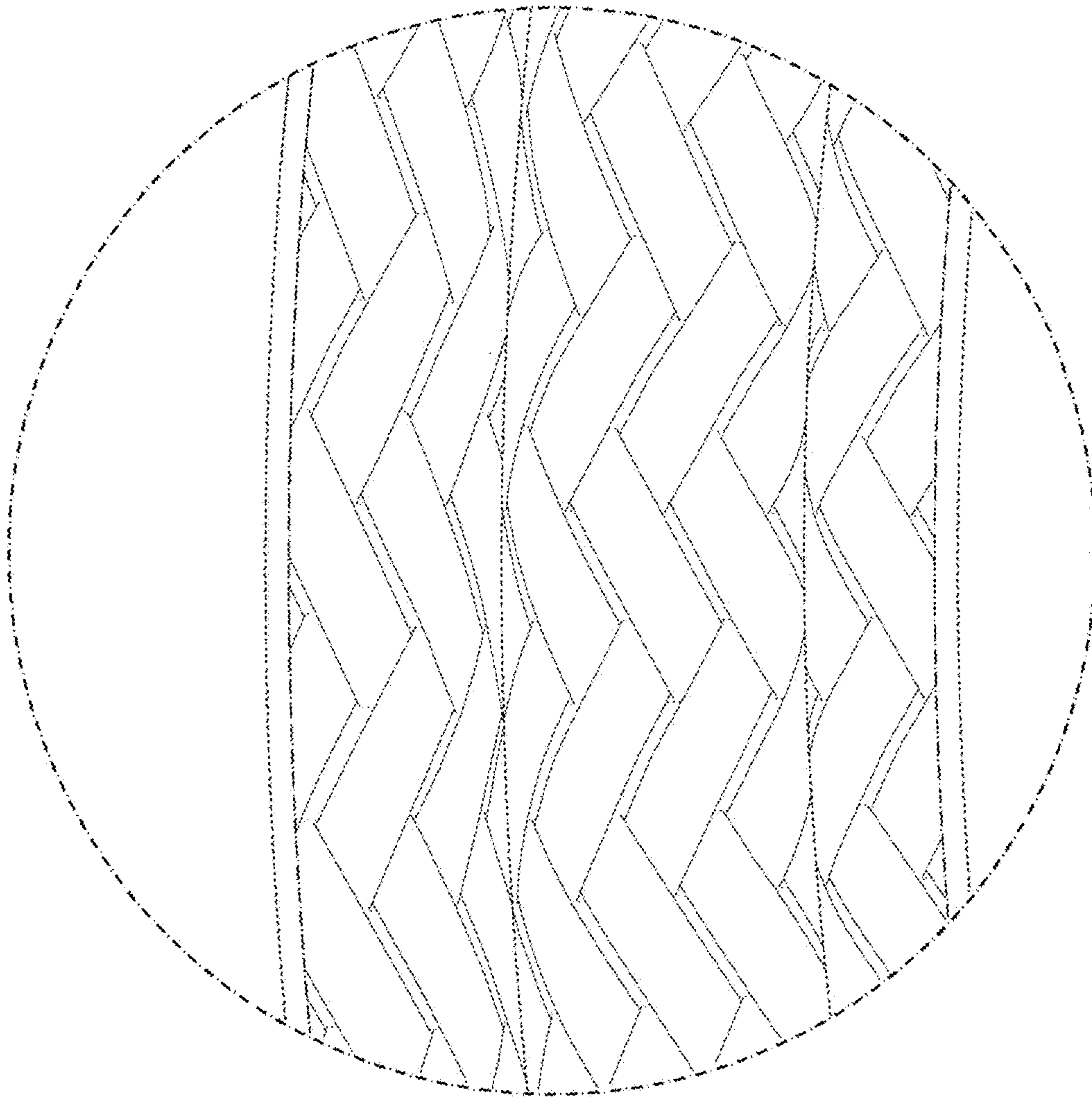

Fig. 26



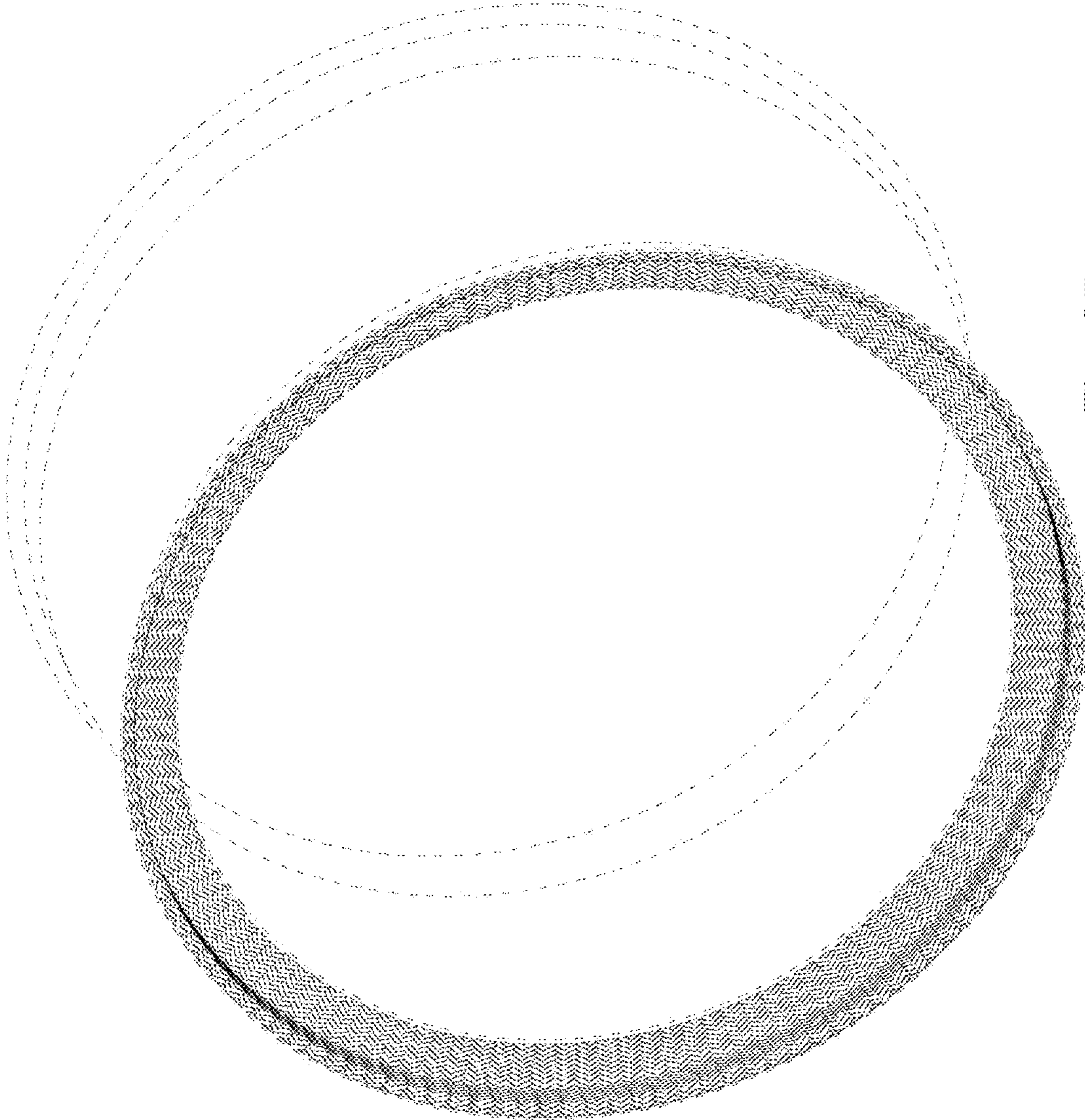

Fig. 27



Fig. 28

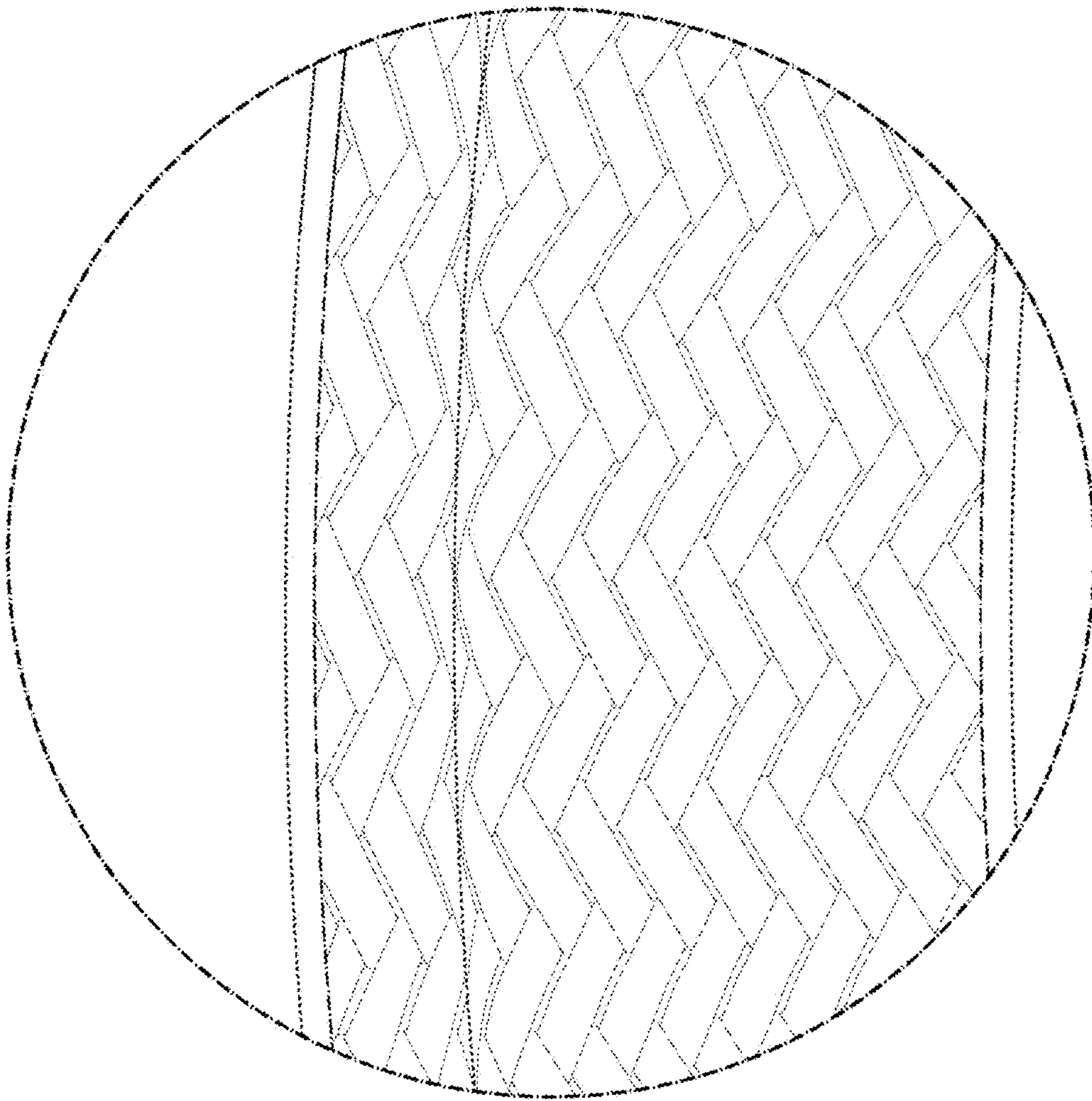

Fig. 29



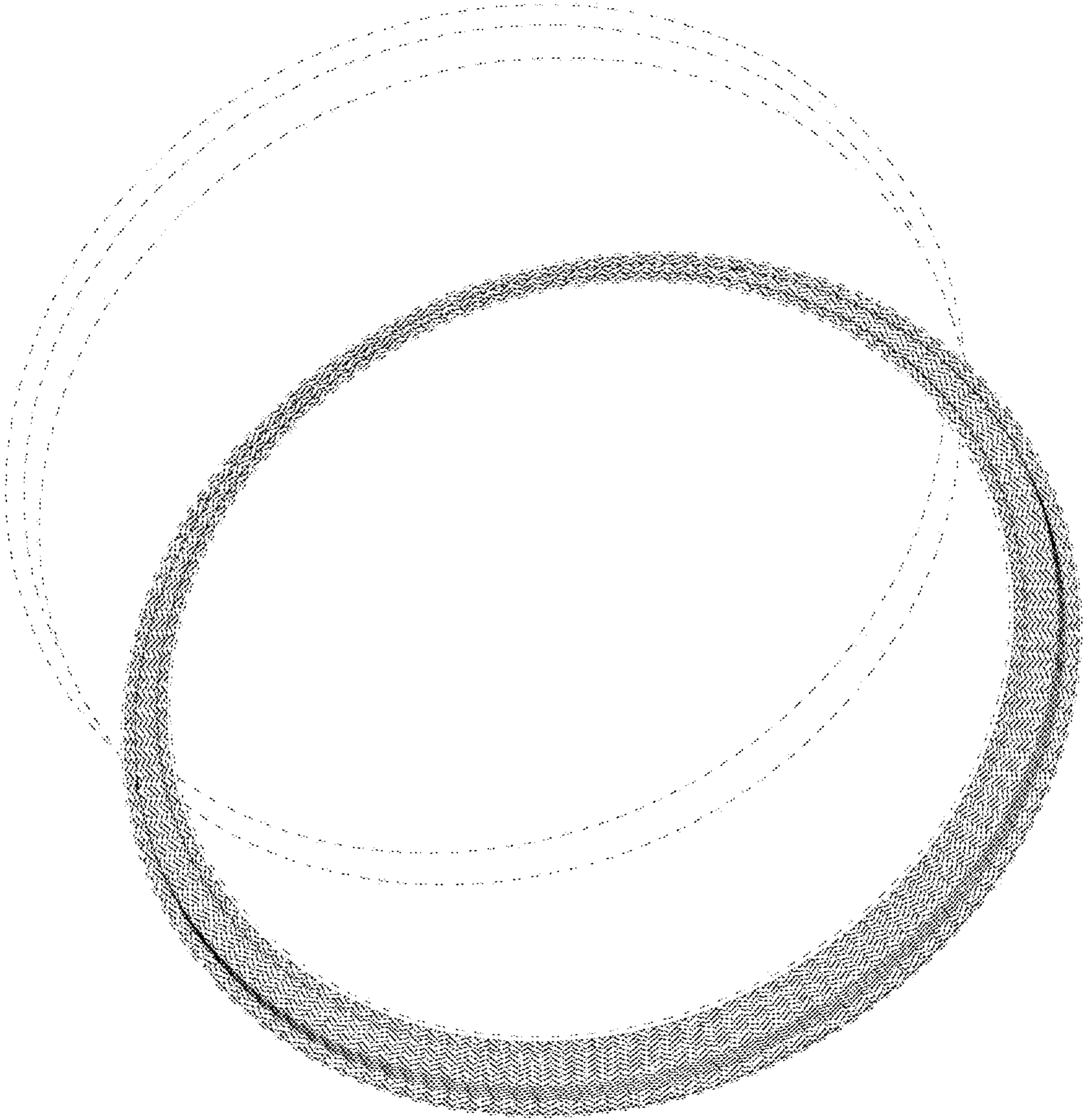

Fig. 30



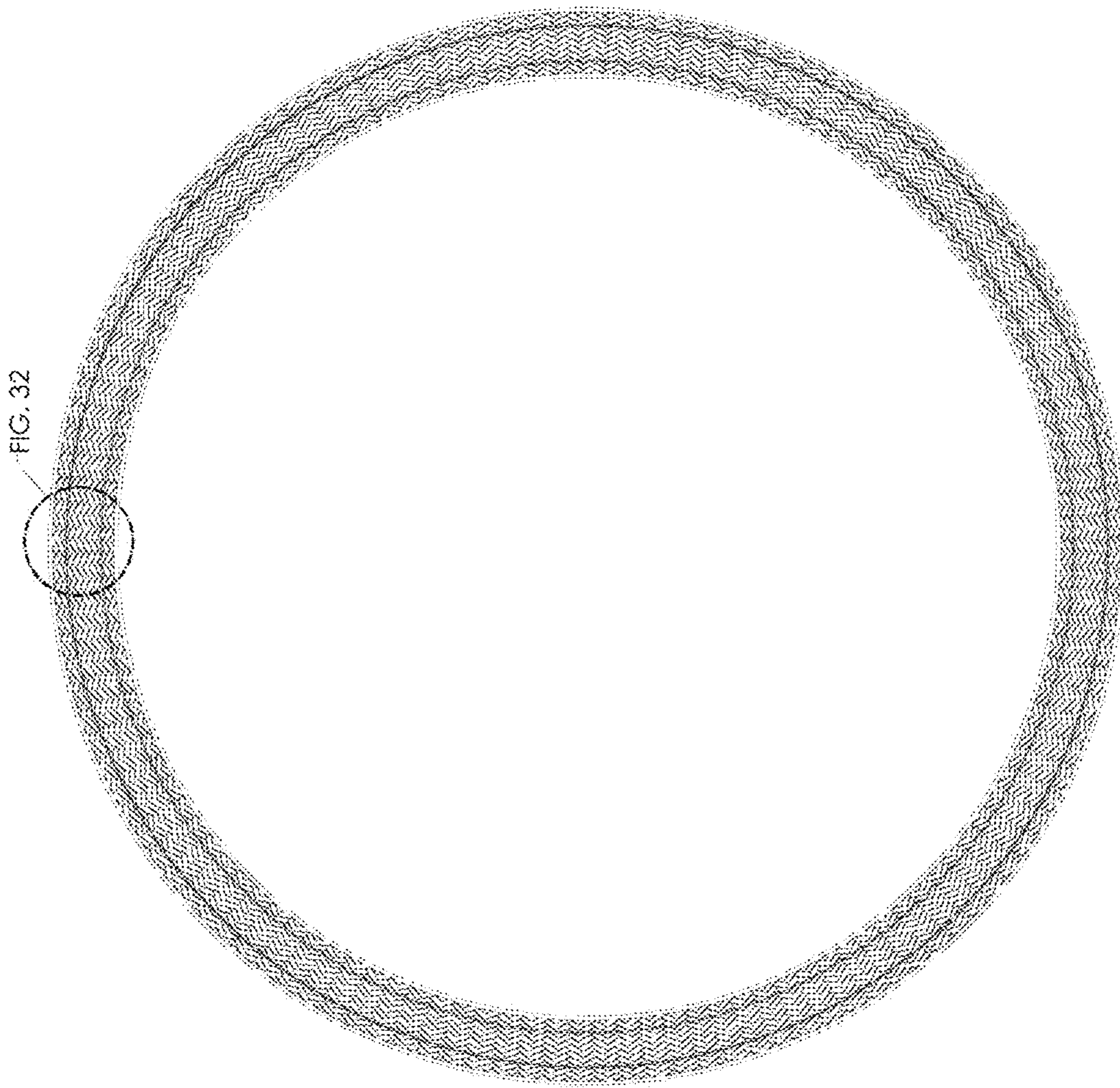

FIG. 32

Fig. 31

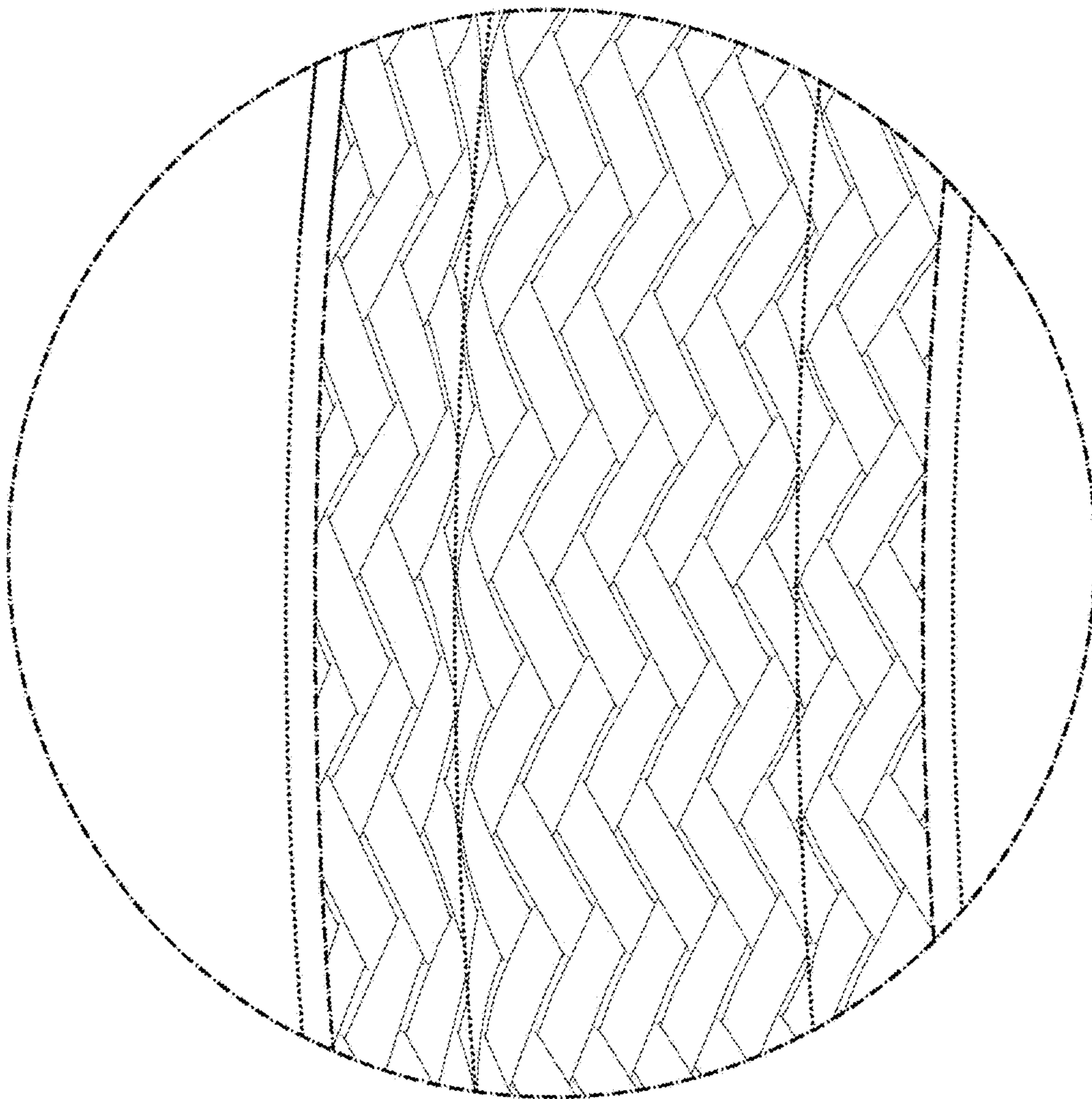

Fig. 32