



US00D823208S

(12) **United States Design Patent** (10) **Patent No.:** **US D823,208 S**
Boyes et al. (45) **Date of Patent:** **** Jul. 17, 2018**

(54) **FRONT DOOR CASING AND REAR DOOR CASING**

(71) Applicant: **Jaguar Land Rover Limited**, Whitley, Coventry (GB)

(72) Inventors: **Sandy Boyes**, Coventry (GB); **Andy Webber**, Coventry (GB)

(73) Assignee: **Jaguar Land Rover Limited**, Whitley, Coventry (GB)

(**) Term: **15 Years**

(21) Appl. No.: **29/600,287**

(22) Filed: **Apr. 11, 2017**

(30) **Foreign Application Priority Data**

Oct. 17, 2016 (EM) 003421965-0005

Oct. 17, 2016 (EM) 003421965-0006

(51) **LOC (11) Cl.** **12-16**

(52) **U.S. Cl.**
USPC **D12/195**

(58) **Field of Classification Search**
USPC D12/195.193, 414, 190, 196; D15/28,
D15/196, 17; D10/46, 98, 102–103;
D8/302–303

(Continued)

(56) **References Cited**

U.S. PATENT DOCUMENTS

D720,267 S * 12/2014 Norman D12/195

D721,023 S * 1/2015 Wiedeman D12/195

D722,933 S * 2/2015 Ishikawa D12/195

D743,863 S * 11/2015 Finney D12/195

(Continued)

Primary Examiner — Katrina A Betton

(74) *Attorney, Agent, or Firm* — Wood Herron & Evans LLP

(57) **CLAIM**

The ornamental design for a front door casing and rear door casing, as shown and described.

DESCRIPTION

FIG. 1 is a front left perspective view of a front door casing for a vehicle according to the present invention.

FIG. 2 is a front right perspective view of the front door casing shown in FIG. 1.

FIG. 3 is a rear right perspective view thereof.

FIG. 4 is a rear left perspective view thereof.

FIG. 5 is a front view thereof.

FIG. 6 is a rear view thereof.

FIG. 7 is a left side view thereof.

FIG. 8 is a right side view thereof.

FIG. 9 is a top view thereof.

FIG. 10 is a front left perspective view of a front door casing for a vehicle according to a second embodiment of the present invention.

FIG. 11 is a front right perspective view of the front door casing for a vehicle shown in FIG. 10.

FIG. 12 is a front left perspective view of a rear door casing for a vehicle according to another embodiment of the present invention.

FIG. 13 is a front right perspective view of the rear door casing shown in FIG. 12.

FIG. 14 is a rear right perspective view thereof.

FIG. 15 is a rear left perspective view thereof.

FIG. 16 is a front view thereof.

FIG. 17 is a rear view thereof.

FIG. 18 is a left side view thereof.

FIG. 19 is a right side view thereof.

FIG. 20 is a top view thereof.

FIG. 21 is a front left perspective view of a rear door casing for a vehicle according to a second embodiment of the present invention; and,

FIG. 22 is a front right perspective view of the rear door casing for a vehicle shown in FIG. 21.

The broken dash lines comprise claim boundaries and neither the portions inside the broken dash lines nor the broken dash lines themselves form any part of the claimed invention.

1 Claim, 20 Drawing Sheets

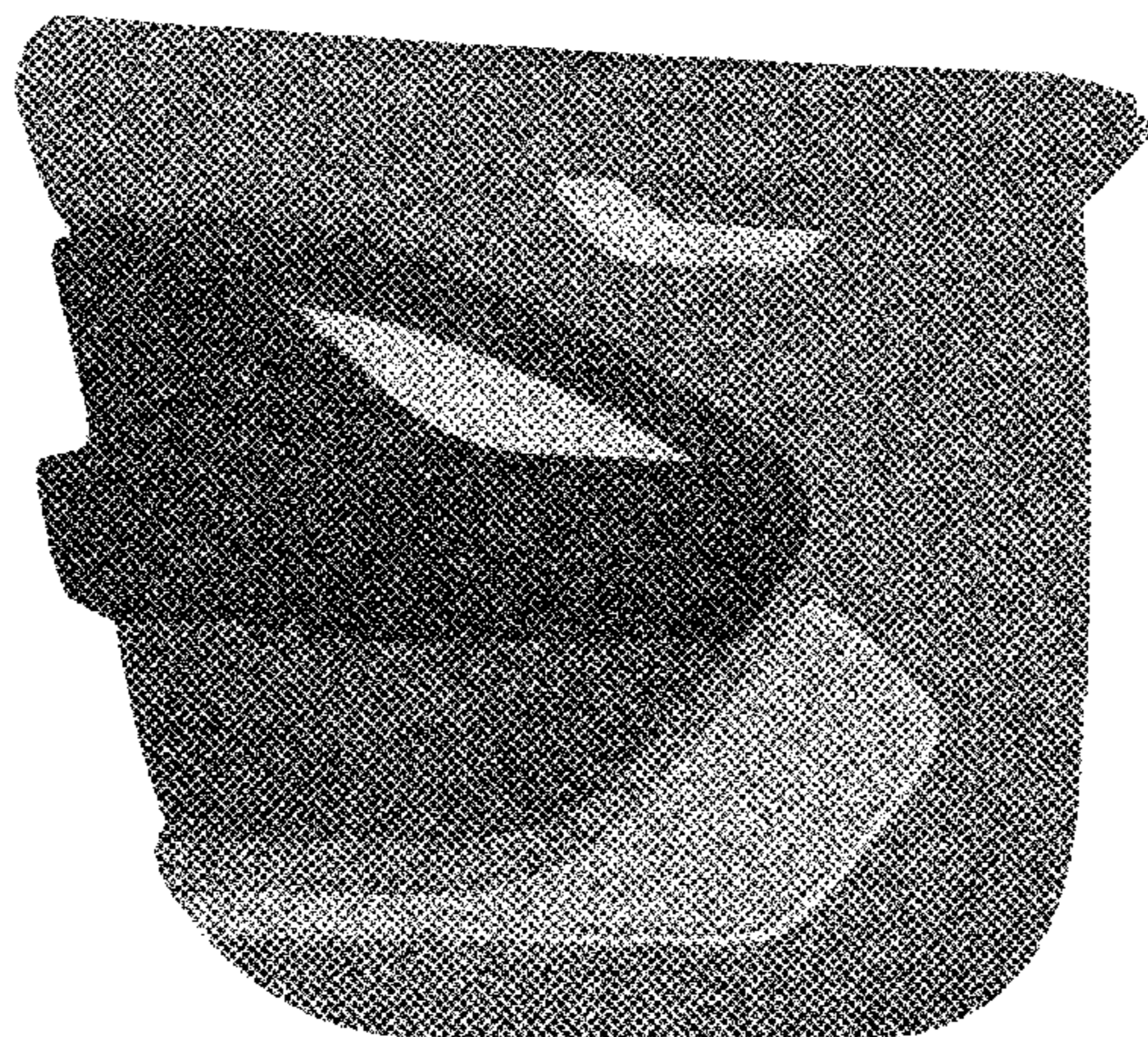

(58) **Field of Classification Search**

CPC B60J 5/04; B60N 2/466; B60N 2/4693;
B60R 13/0243

See application file for complete search history.

(56) **References Cited**

U.S. PATENT DOCUMENTS

D761,176 S *	7/2016	Sandys	D12/195
D763,757 S *	8/2016	Buffery	D12/195
D768,042 S *	10/2016	Lee	D12/195
D783,481 S *	4/2017	Yamamoto	D12/195
D784,882 S *	4/2017	Lee	D12/195
D784,883 S *	4/2017	Lee	D12/195
D801,899 S *	11/2017	Watkin	D12/195
D807,267 S *	1/2018	Higashimori	D12/195

* cited by examiner

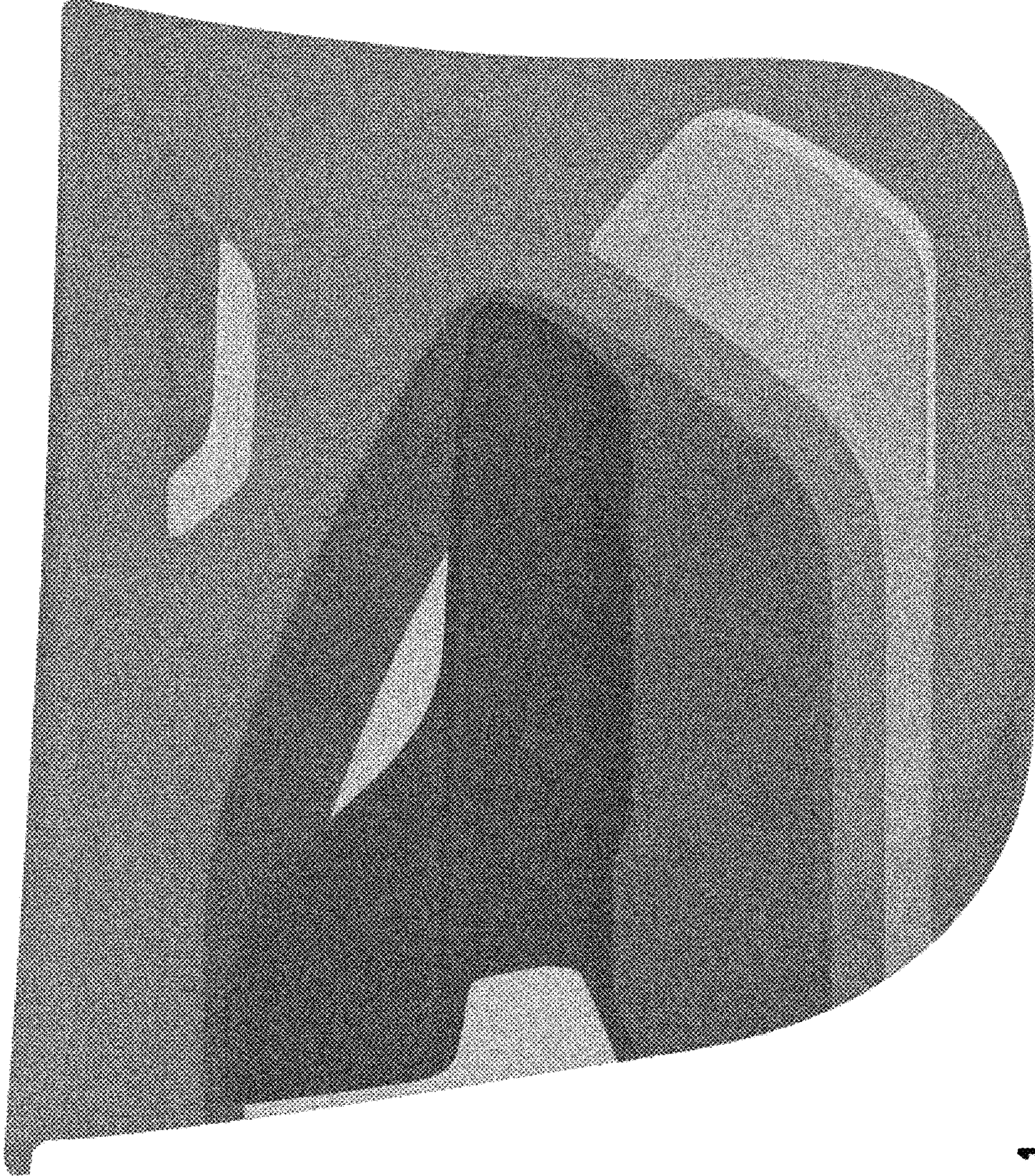

FIG. 1

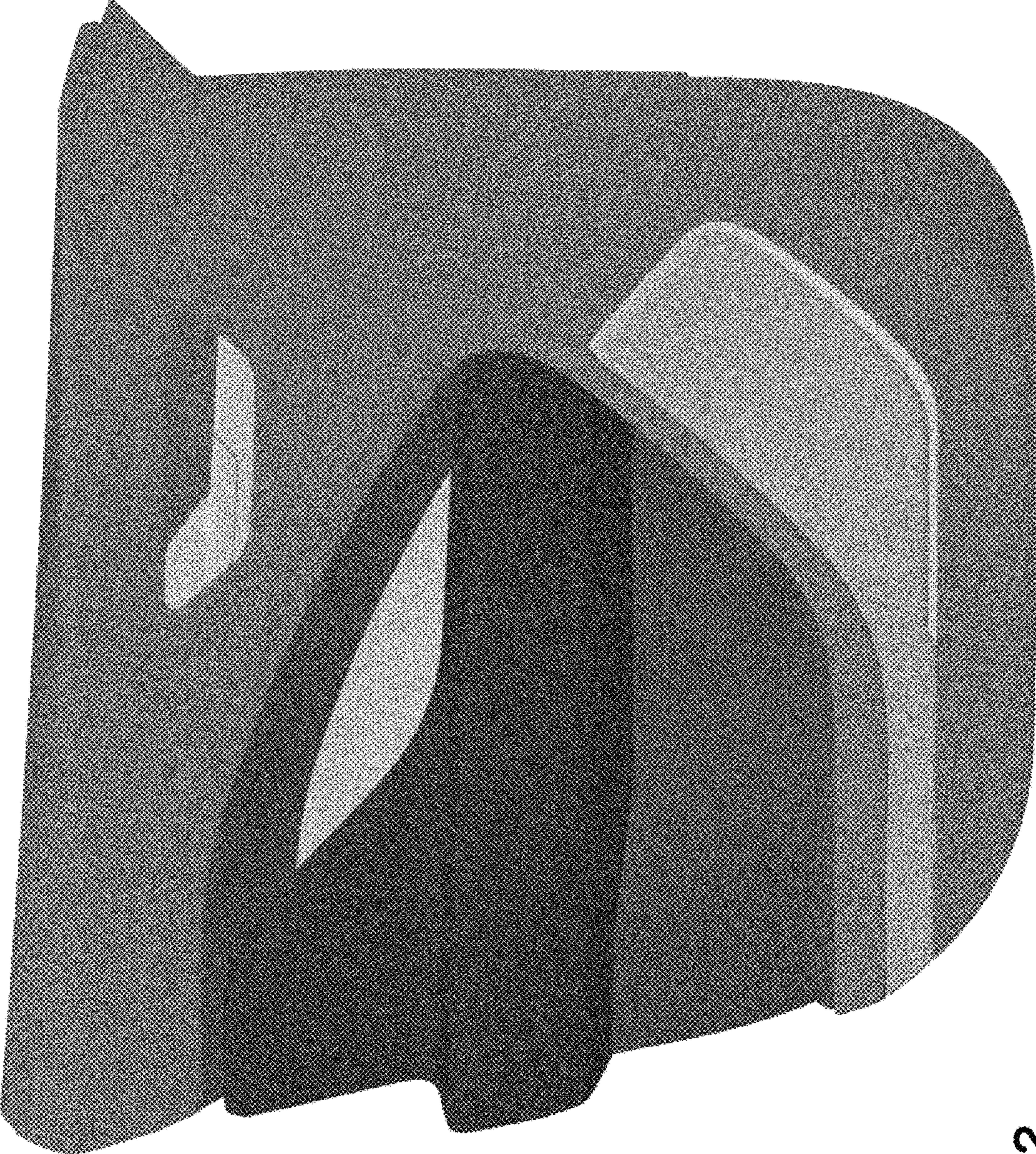

FIG. 2

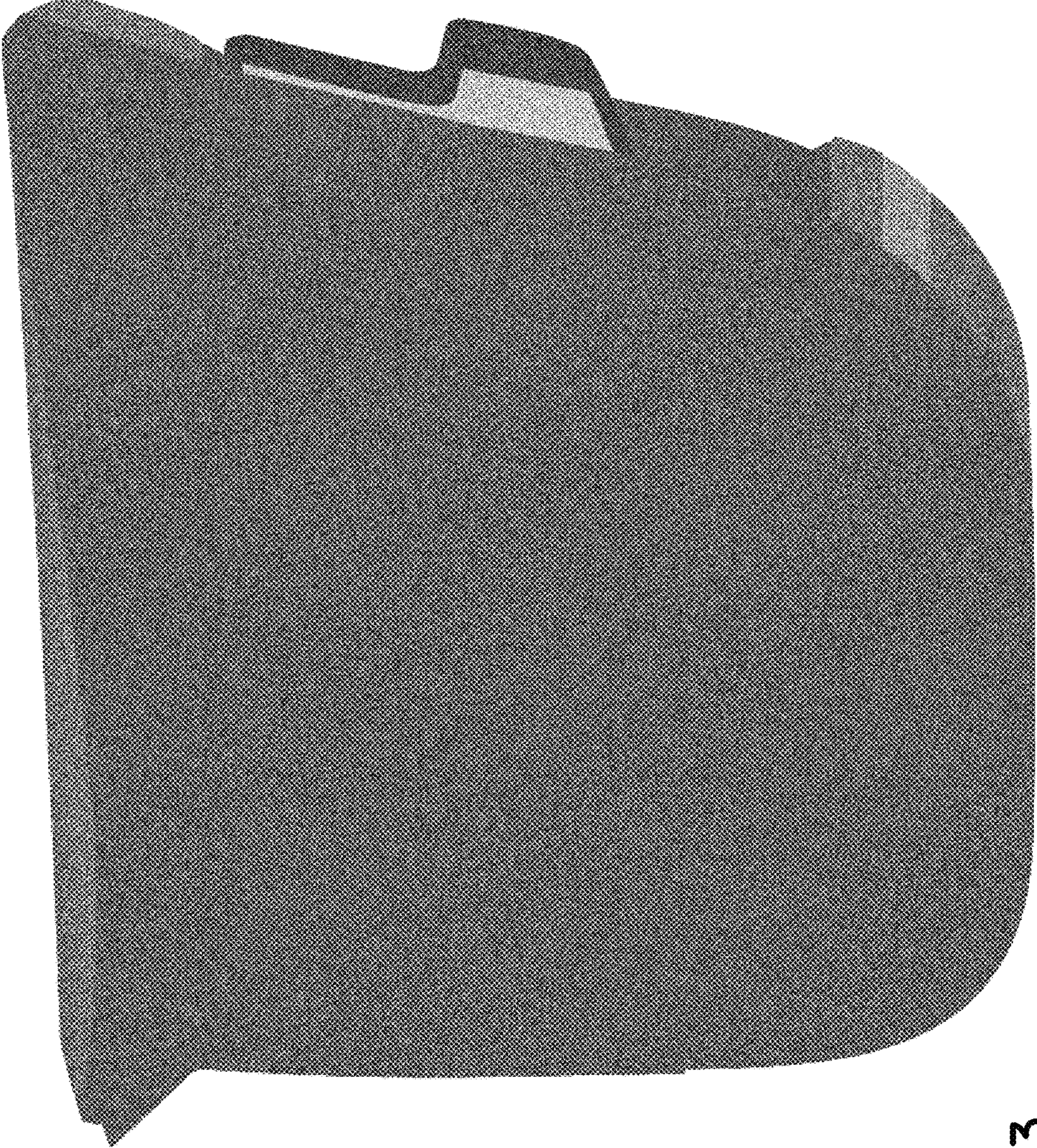

FIG. 3

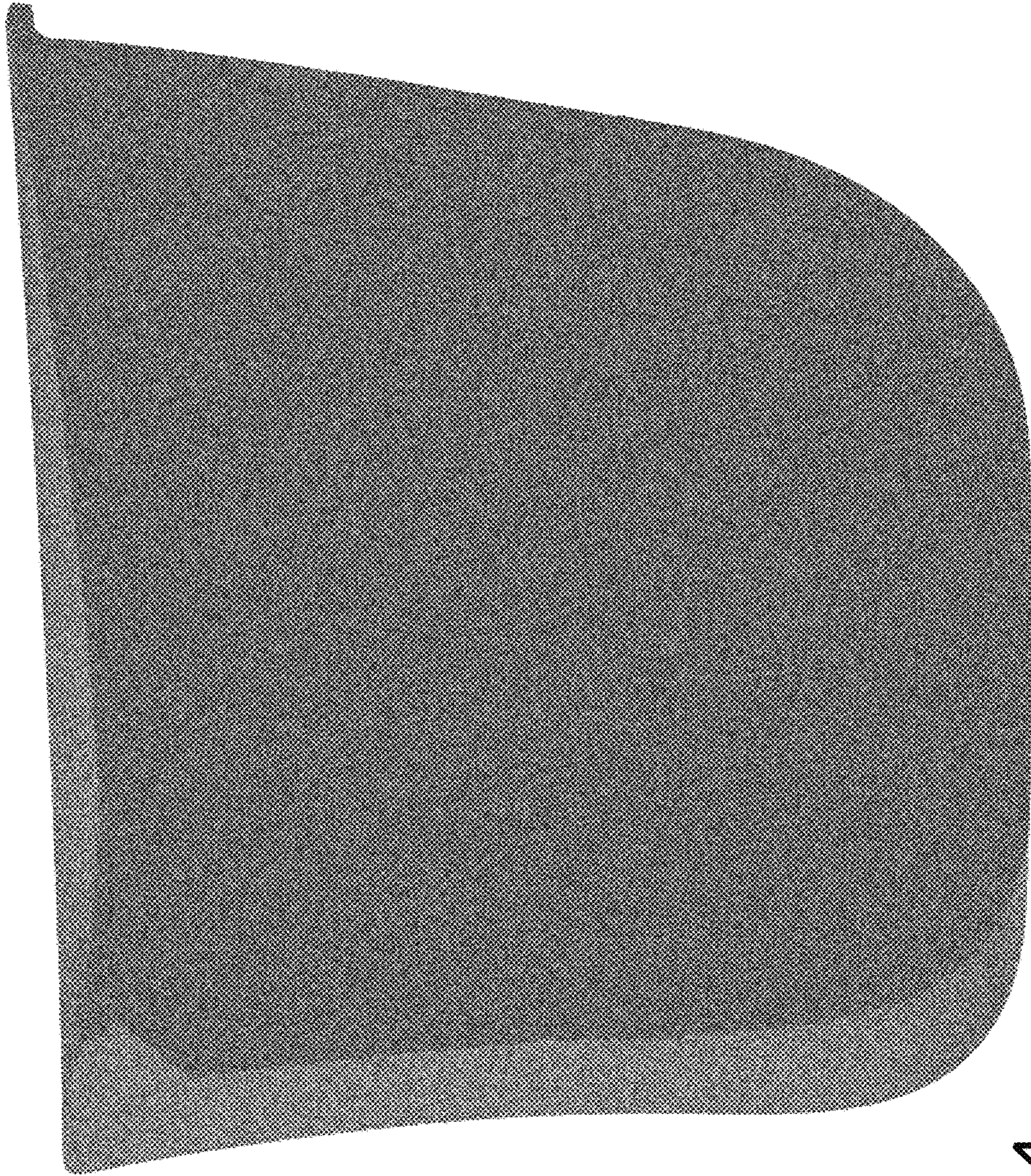

FIG. 4

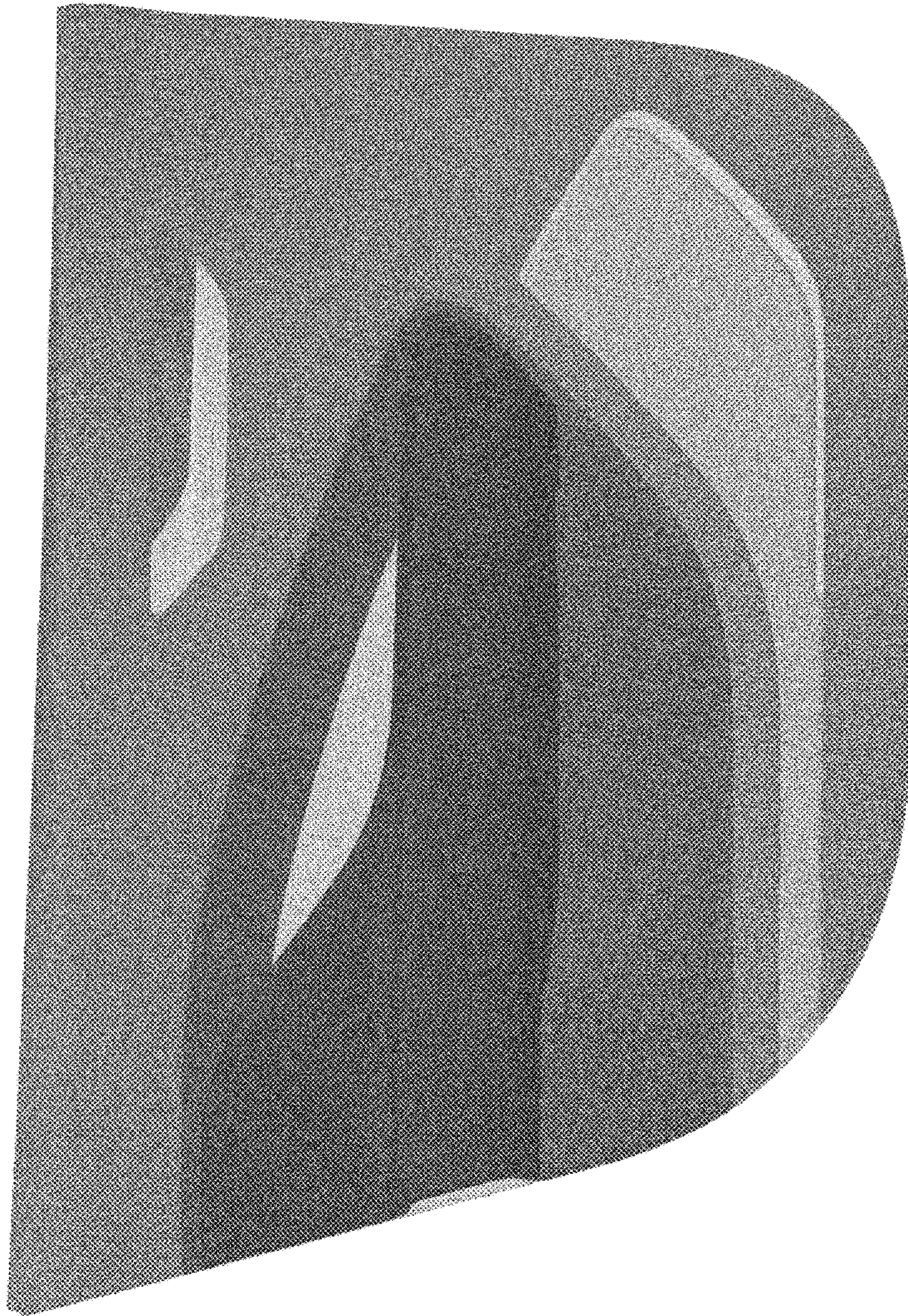

FIG. 5

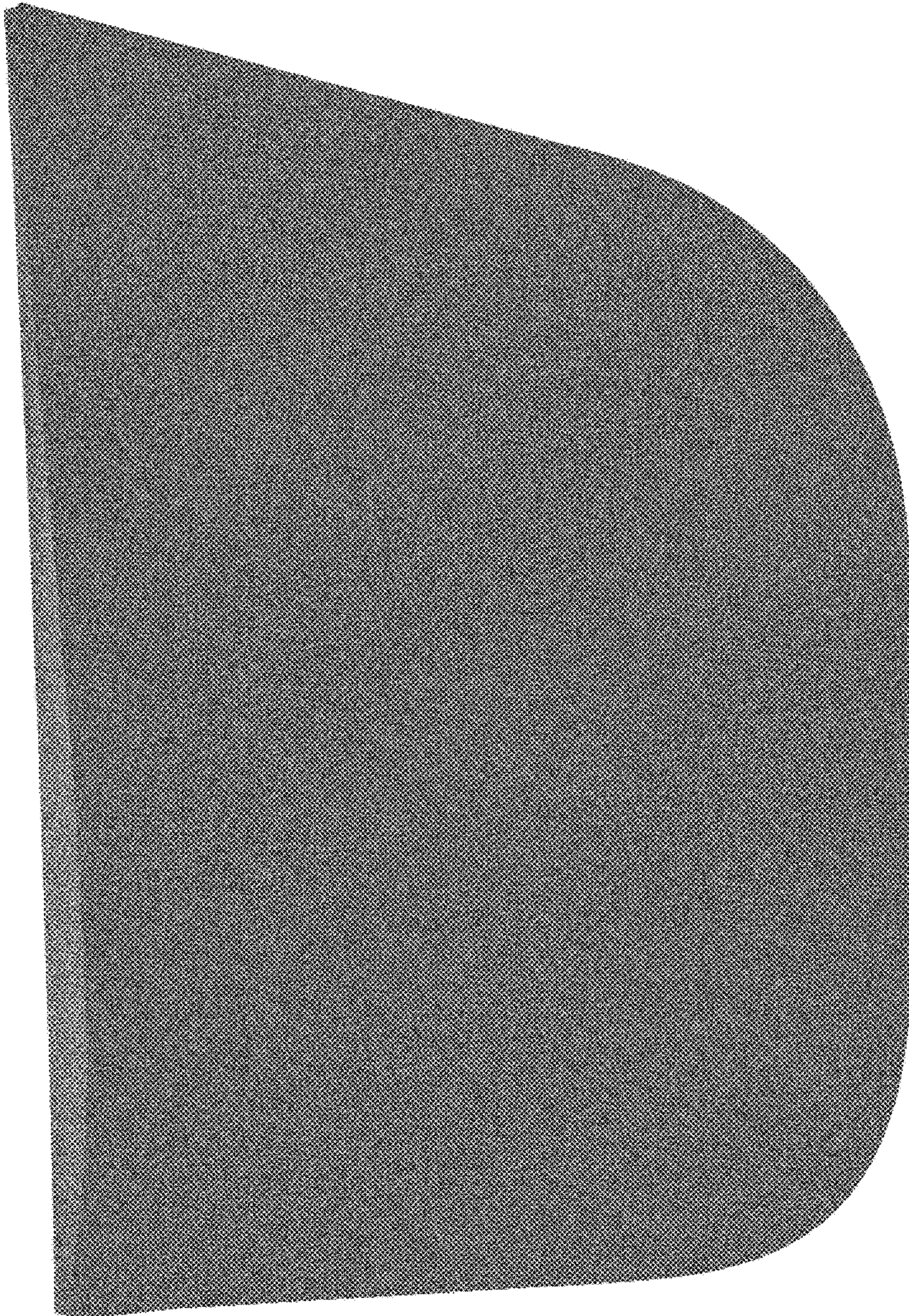

FIG. 6

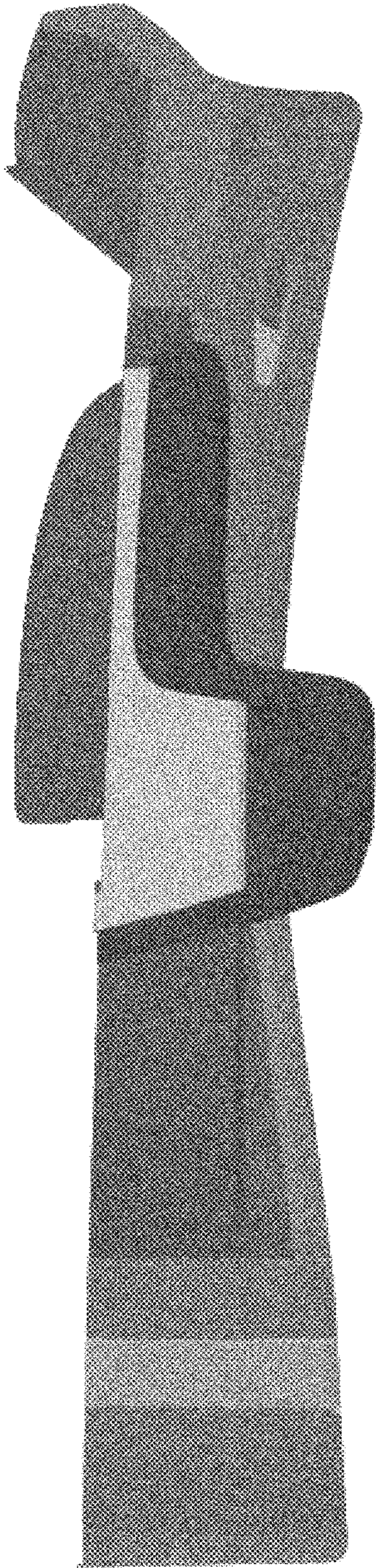

FIG. 7

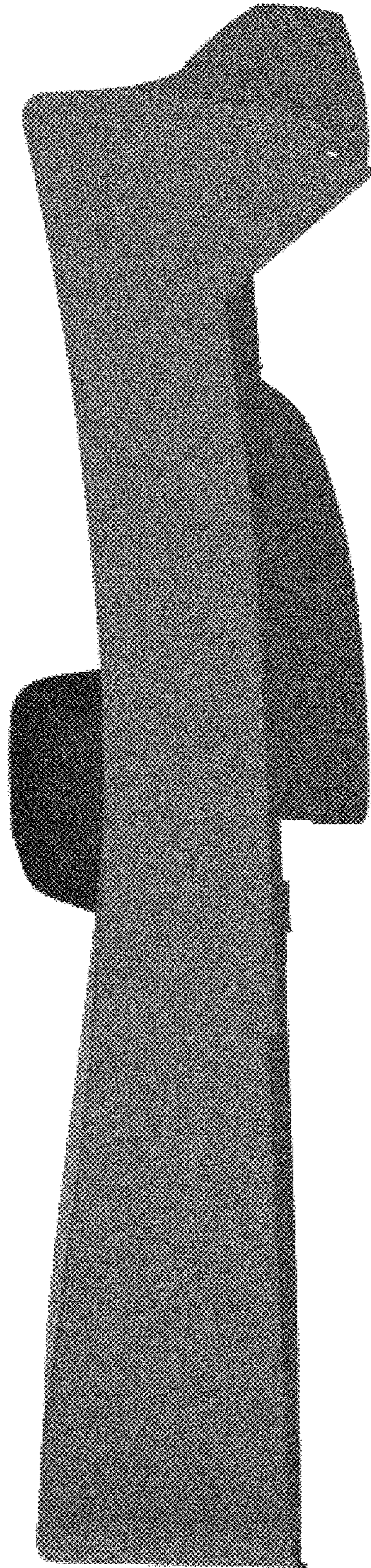

FIG. 8

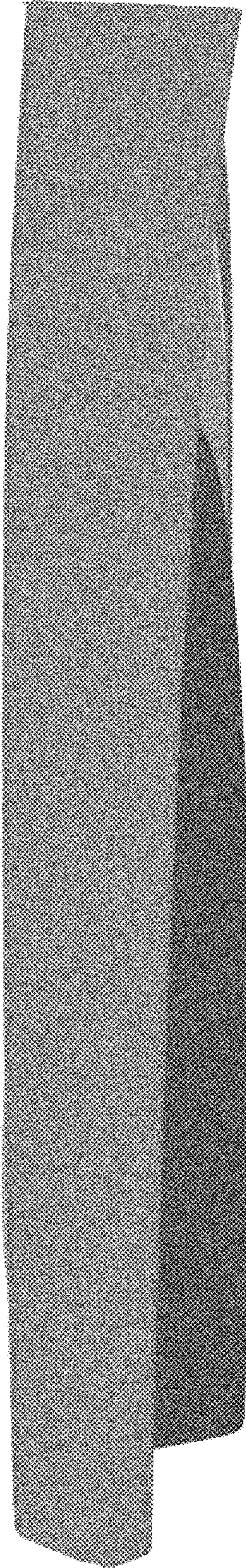

FIG. 9

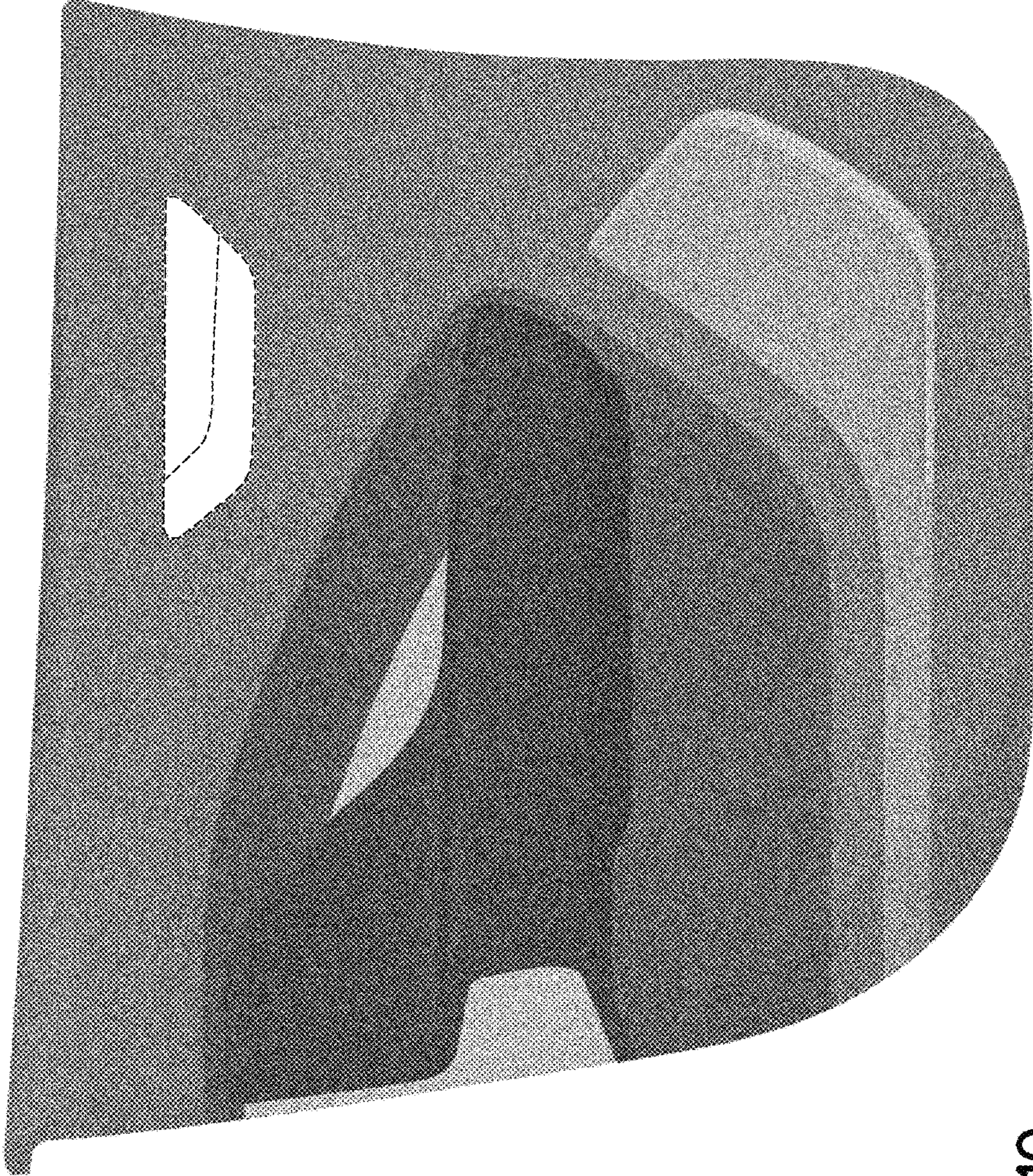

FIG. 10

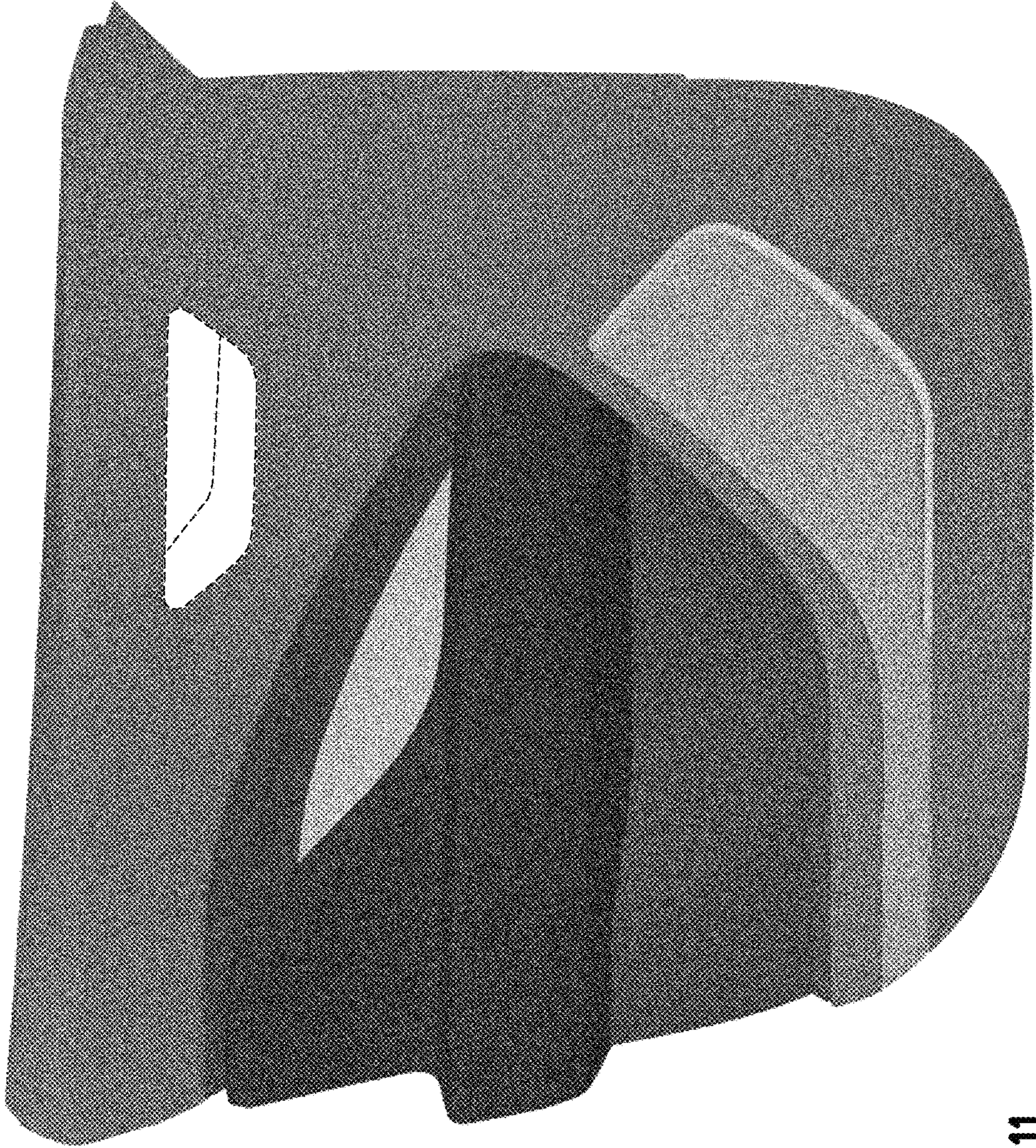

FIG. 11

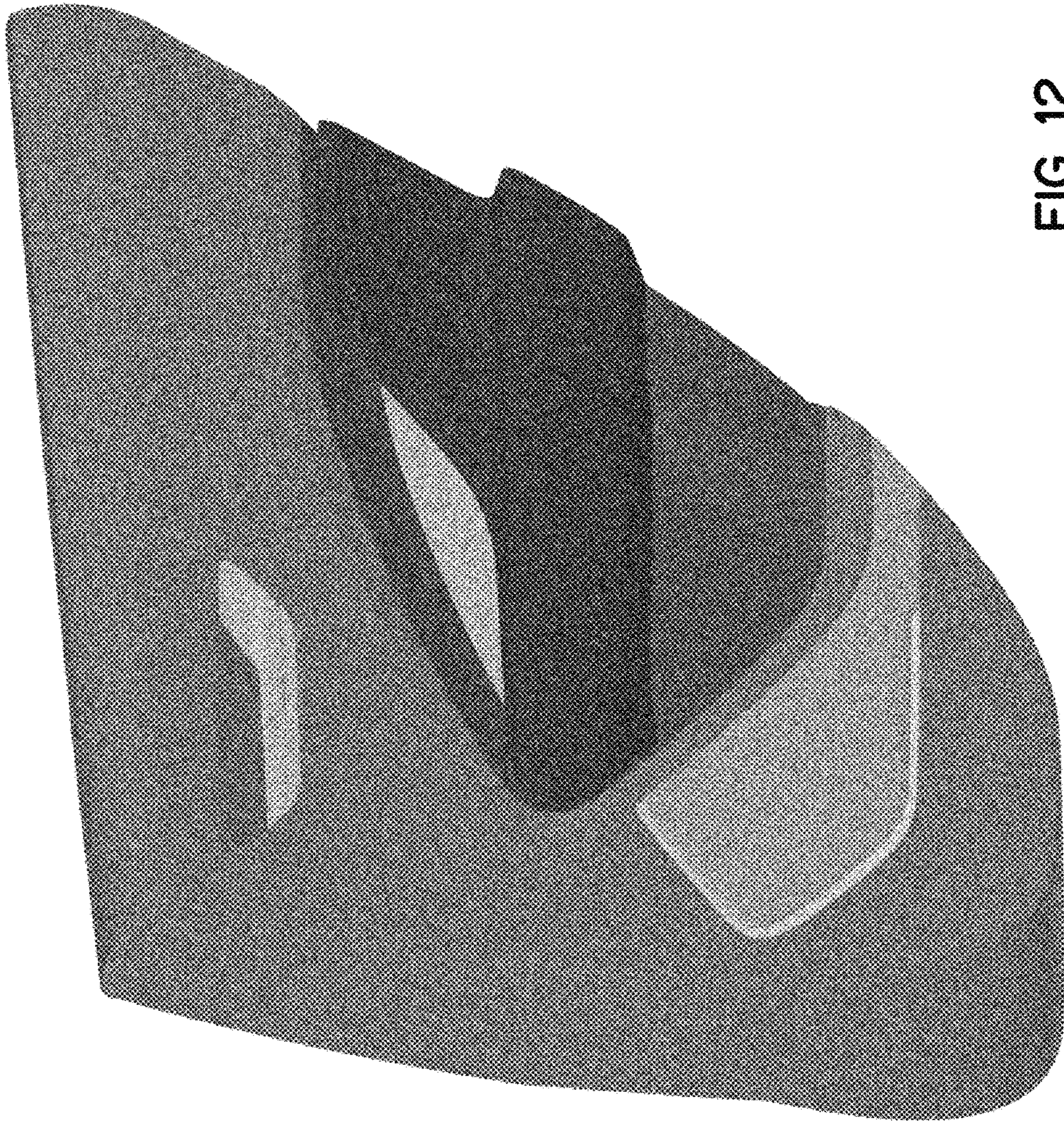

FIG. 12

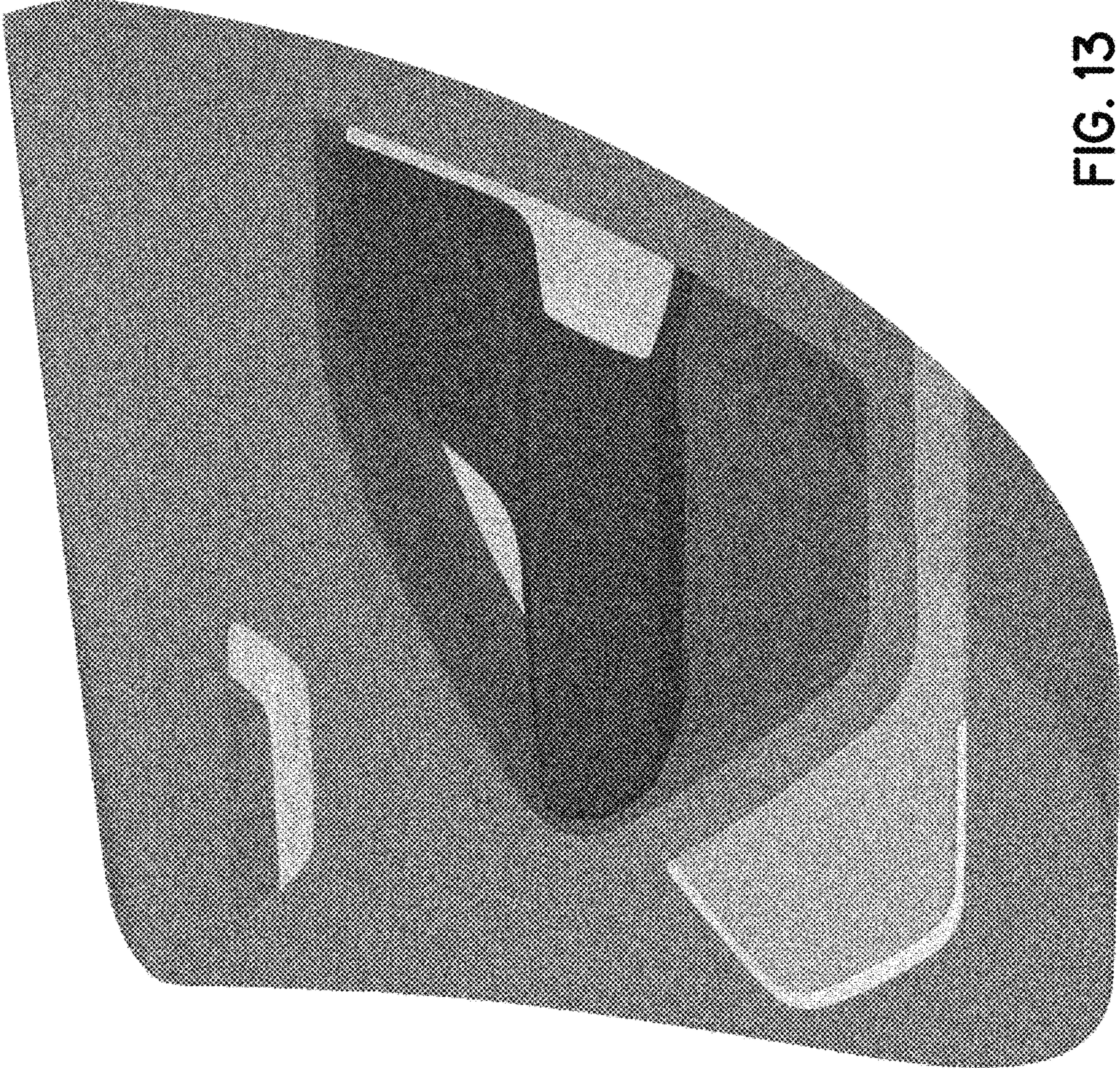

FIG. 13

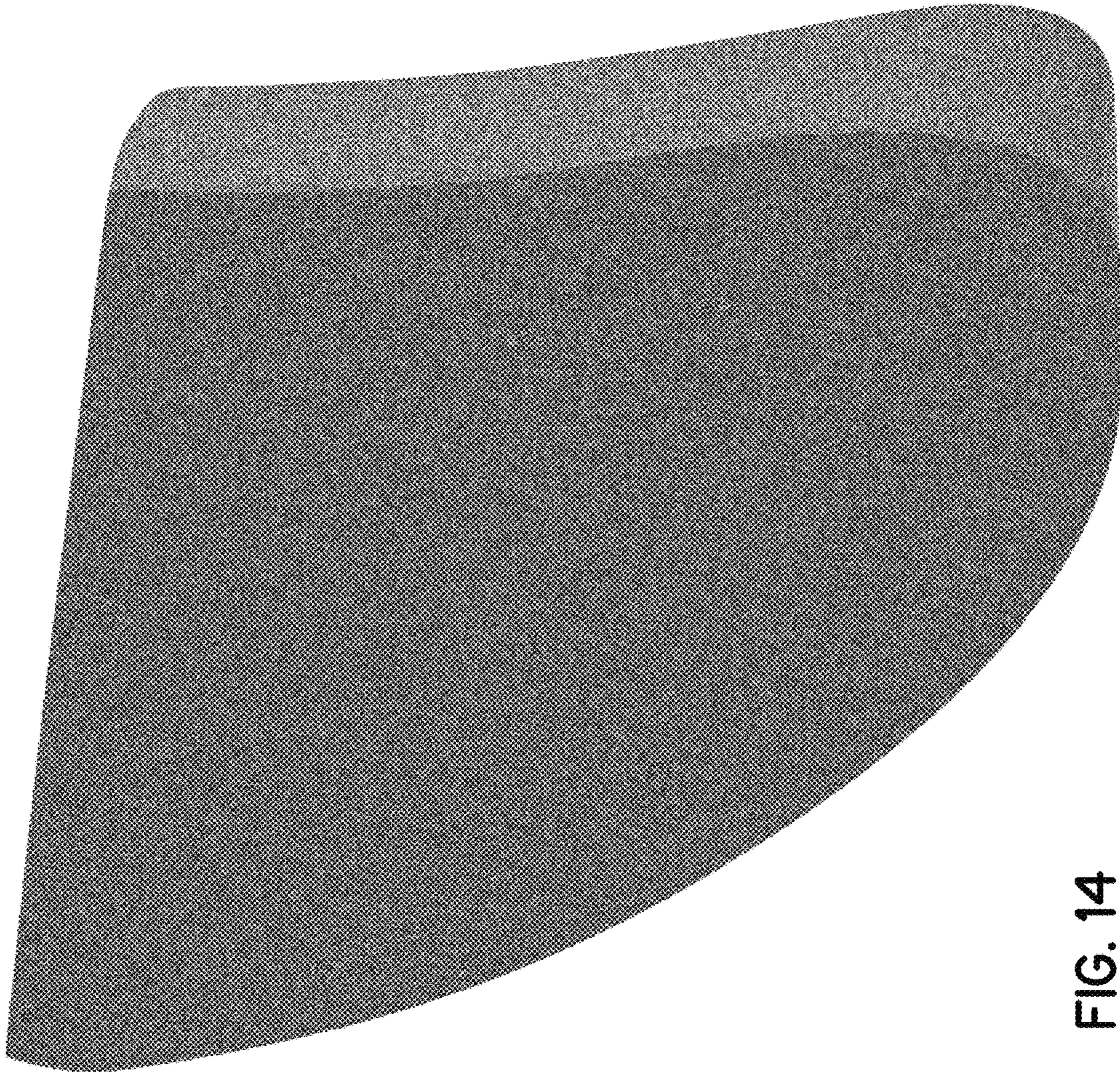

FIG. 14

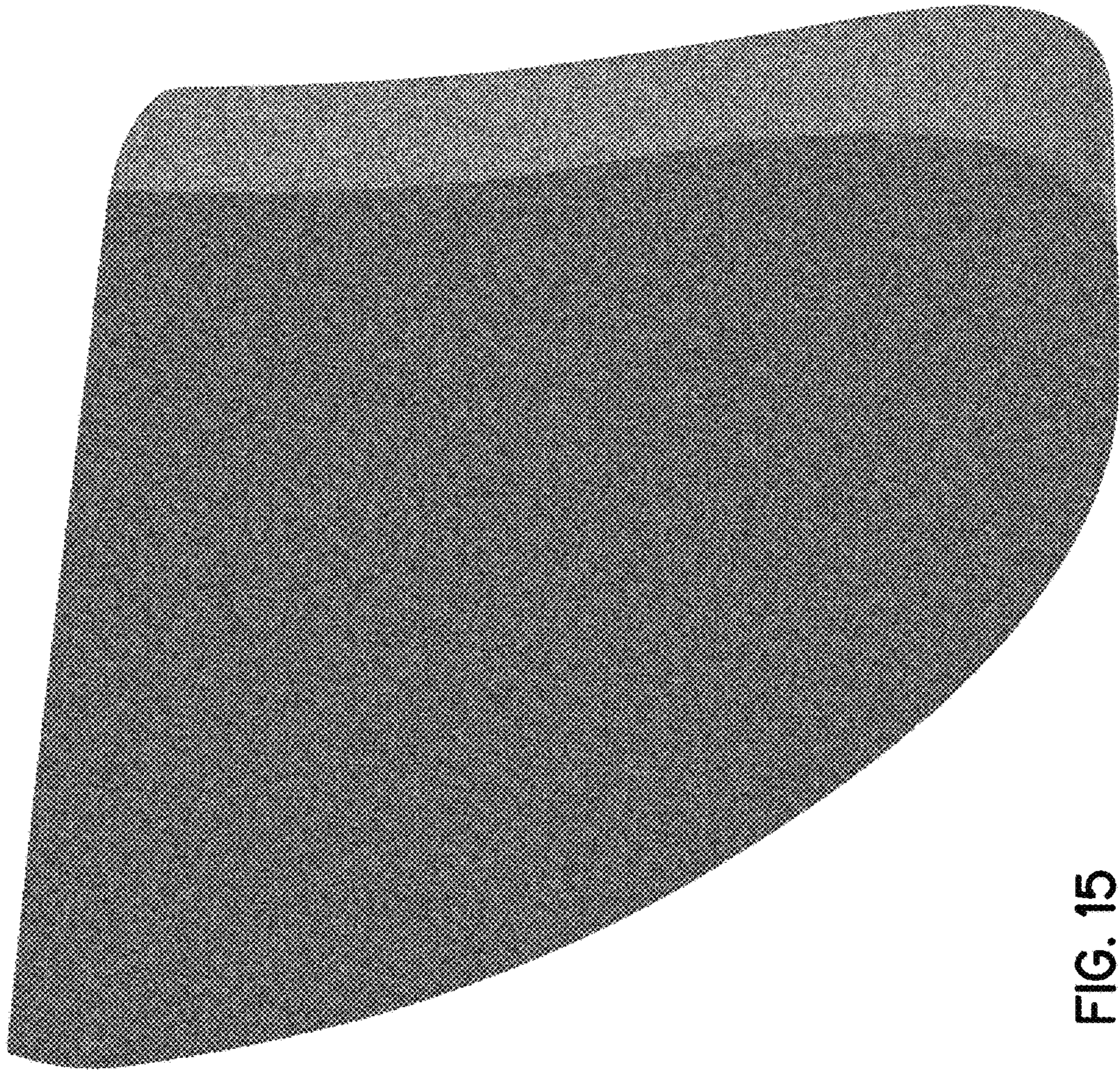

FIG. 15

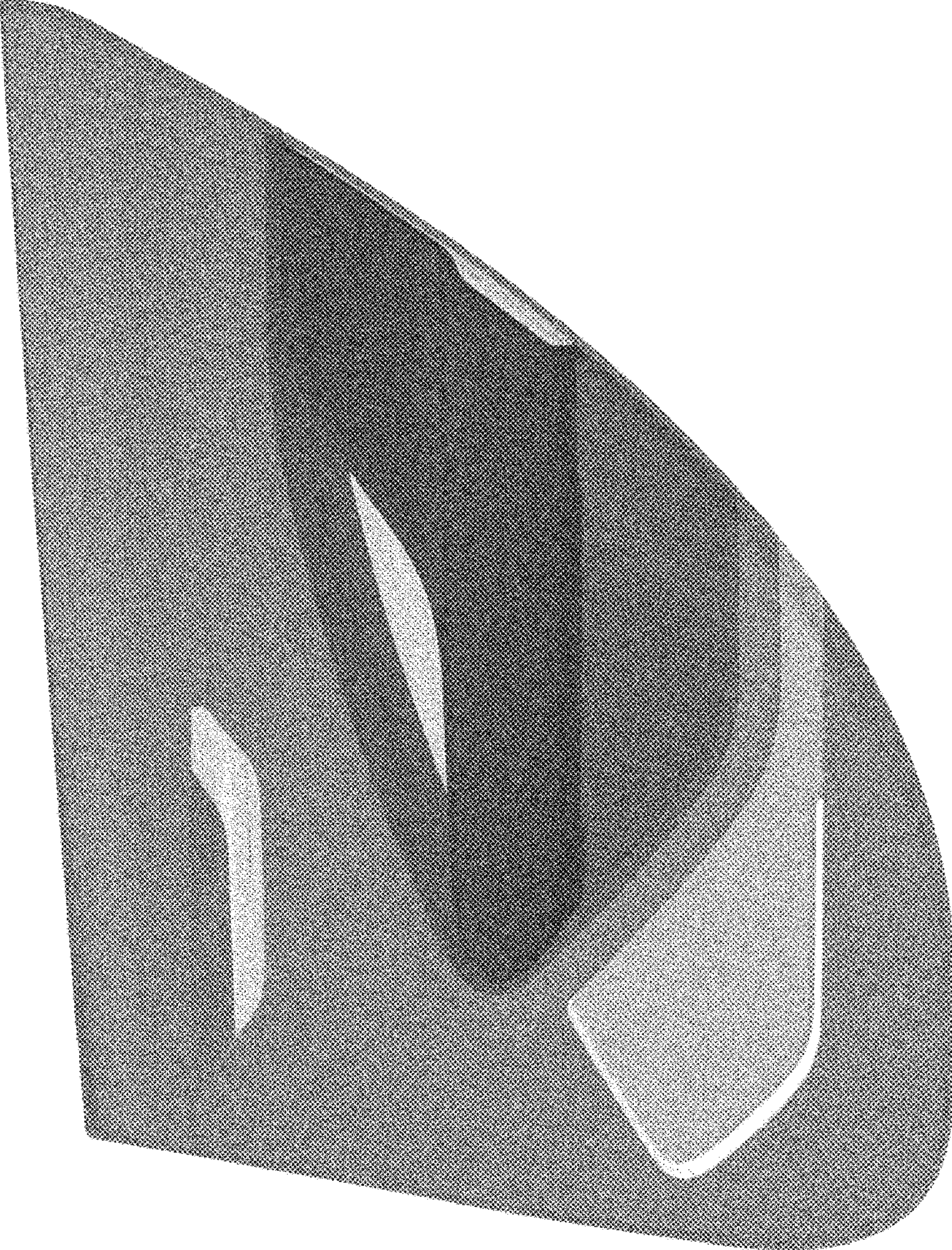

FIG. 16

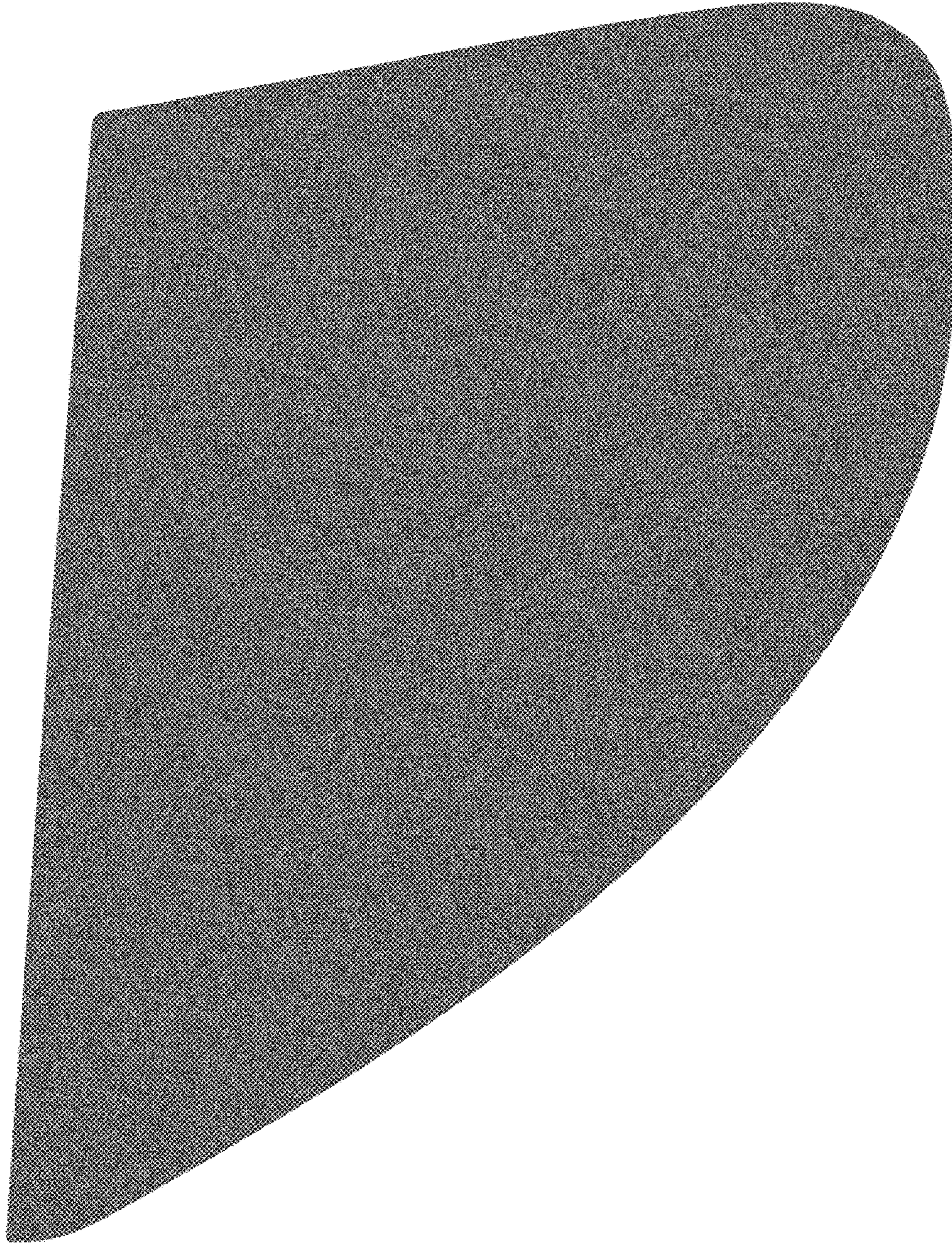

FIG. 17

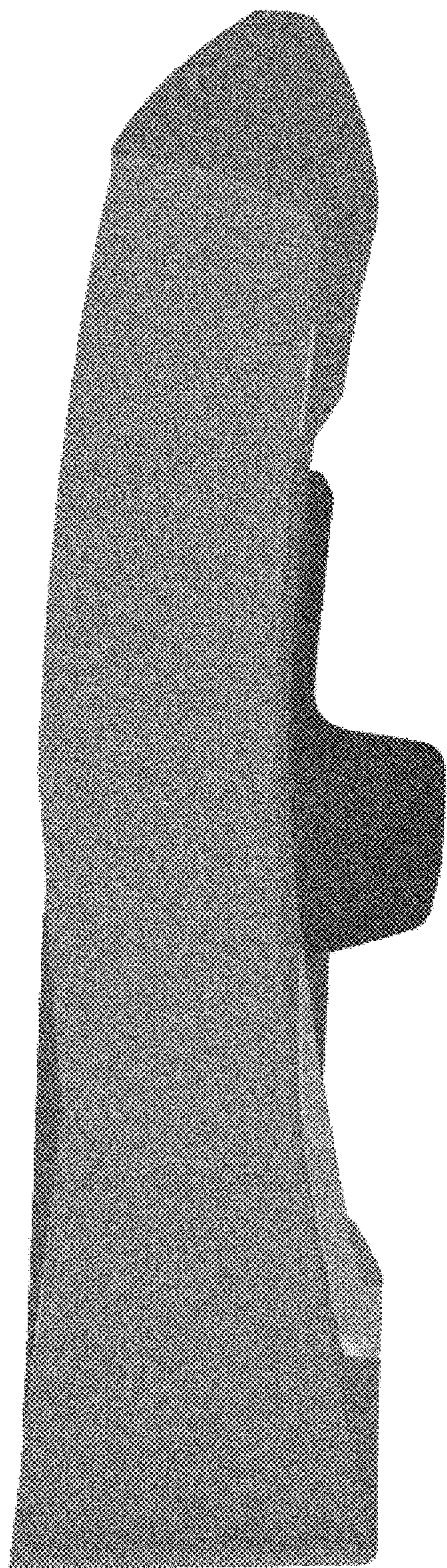

FIG. 18

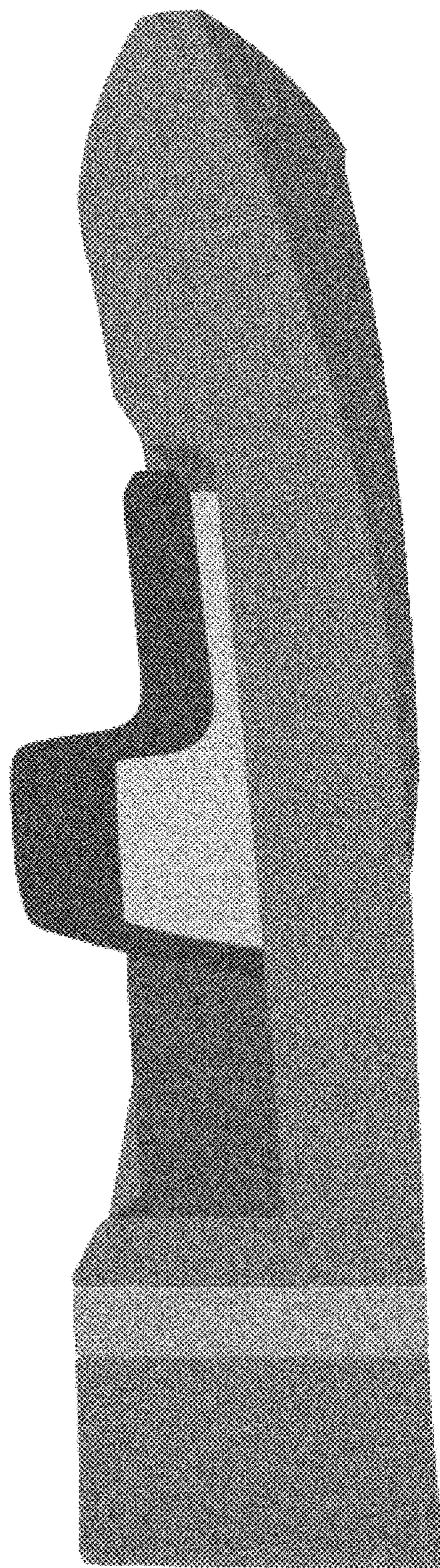

FIG. 19

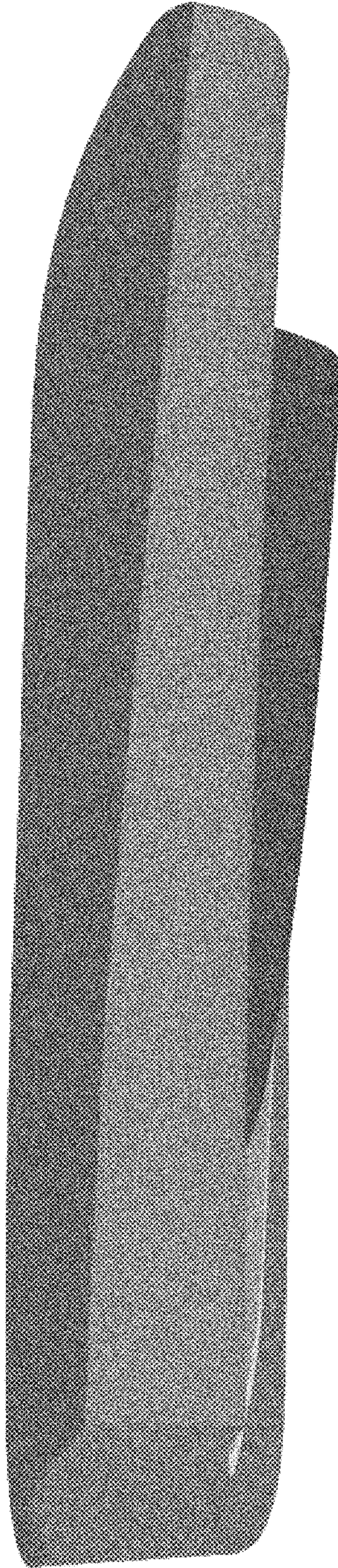

FIG. 20

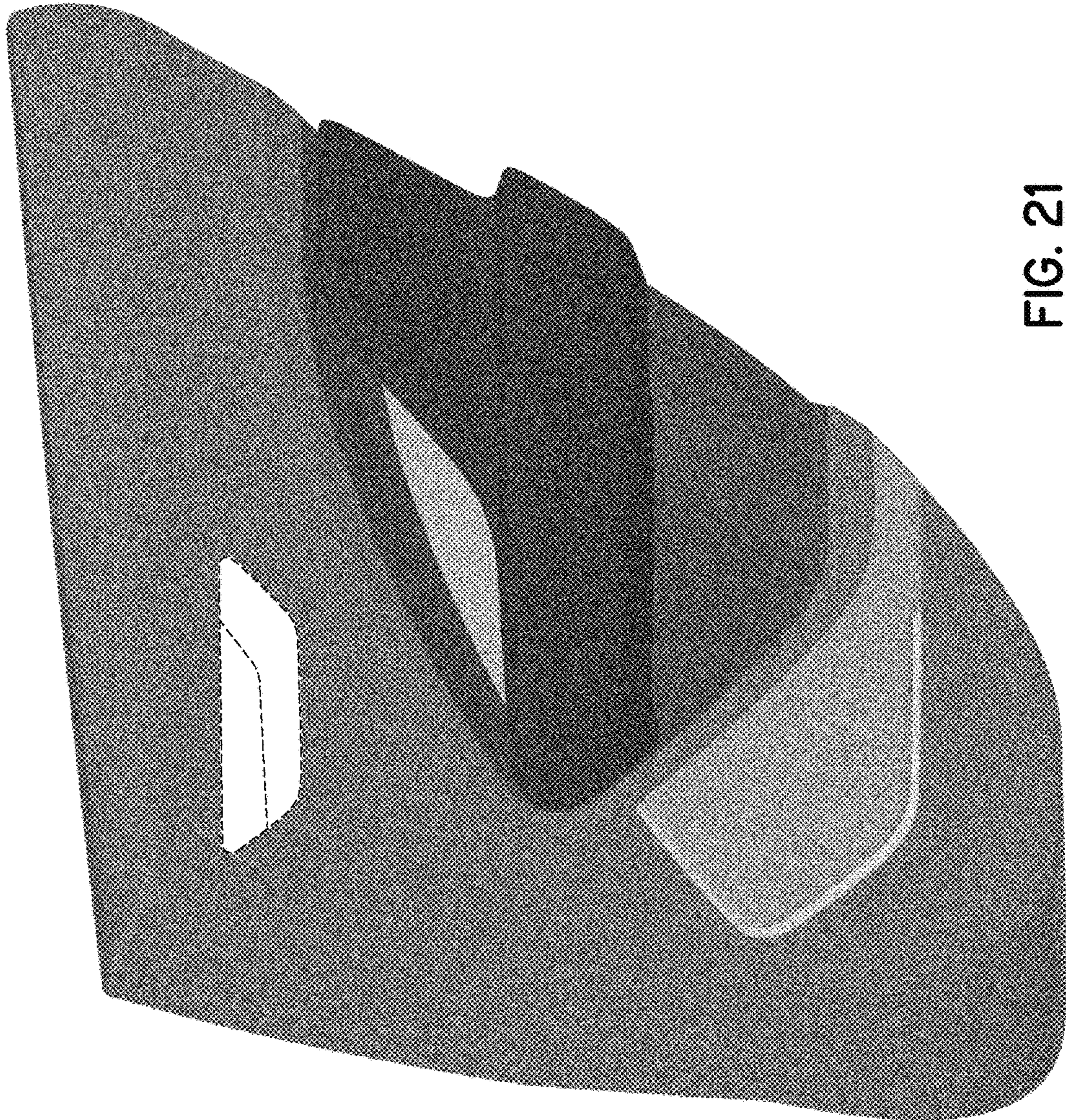

FIG. 21

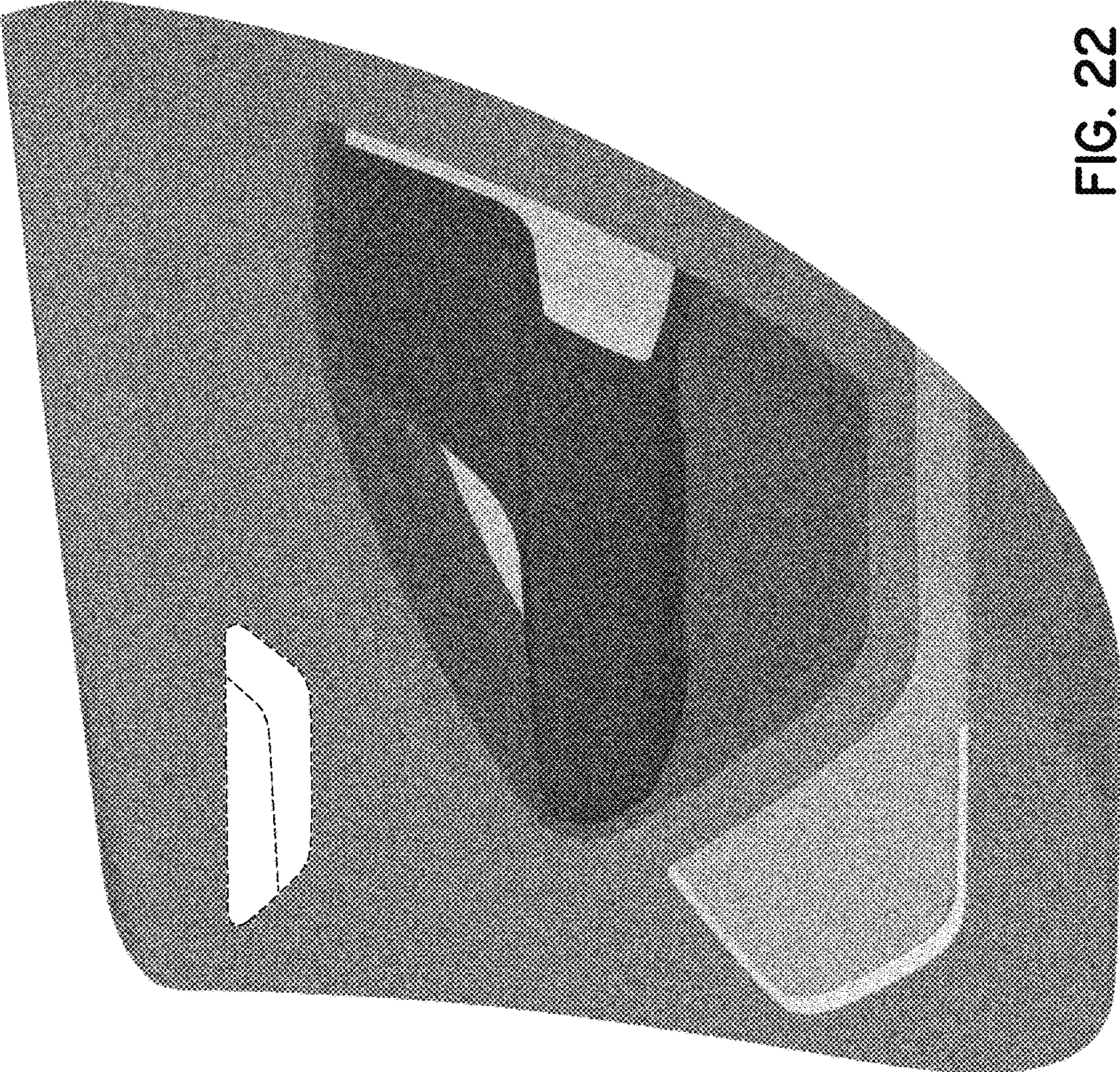

FIG. 22