



US00D823137S

(12) **United States Design Patent**  
**Monachon**

(10) **Patent No.:** **US D823,137 S**  
(45) **Date of Patent:** **\*\* Jul. 17, 2018**

- (54) **WATCH**
- (71) Applicant: **OMEGA LTD.**, Biel/Bienne (CH)
- (72) Inventor: **Jean-Claude Monachon**, Bevaix (CH)
- (73) Assignee: **OMEGA LTD**, Bile/Bienne (CH)
- (\*\*) Term: **15 Years**
- (21) Appl. No.: **29/602,109**
- (22) Filed: **Apr. 28, 2017**

D720,998 S *	1/2015	Galli .....	D10/39
D730,751 S *	6/2015	Belamich .....	D10/126
D736,655 S *	8/2015	Monachon .....	D10/126
D759,511 S *	6/2016	Belamich .....	D10/126

\* cited by examiner

*Primary Examiner* — Sheryl L Lane

*Assistant Examiner* — Samantha N Wood

(74) *Attorney, Agent, or Firm* — Abelman, Frayne & Schwab

(30) **Foreign Application Priority Data**

Nov. 2, 2016 (WO) ..... DM/093 292

(51) **LOC (11) Cl.** ..... **10-02**

(52) **U.S. Cl.**  
USPC ..... **D10/38**

(58) **Field of Classification Search**  
USPC ..... D10/1–29, 30, 31, 33, 34, 37, 38, 39,  
D10/122, 123, 124, 126, 127; D11/1, 2,  
D11/3  
CPC ..... G04B 3/04; G04B 3/048; G04B 19/00;  
G04B 19/02; G04B 19/04; G04B 19/044;  
G04B 19/048; G04B 19/06; G04B 19/10;  
G04B 19/065; G04B 5/005; G04B 5/20;  
G04B 19/08

See application file for complete search history.

(56) **References Cited**

**U.S. PATENT DOCUMENTS**

D11,689 S *	3/1880	Hunziker .....	D10/131
D504,830 S *	5/2005	Sugisawa .....	D10/39
D697,435 S *	1/2014	Duport .....	D10/39
D711,750 S *	8/2014	Monachon .....	D10/39

(57) **CLAIM**

The ornamental design for a watch, as shown.

**DESCRIPTION**

FIG. 1 is a front right perspective view of a watch showing my new design;

FIG. 2 is a rear left perspective view thereof;

FIG. 3 is a front view thereof;

FIG. 4 is a rear view thereof;

FIG. 5 is a left side view thereof;

FIG. 6 is a right side view thereof;

FIG. 7 is a bottom view thereof; and,

FIG. 8 is a top view thereof.

**1 Claim, 6 Drawing Sheets**

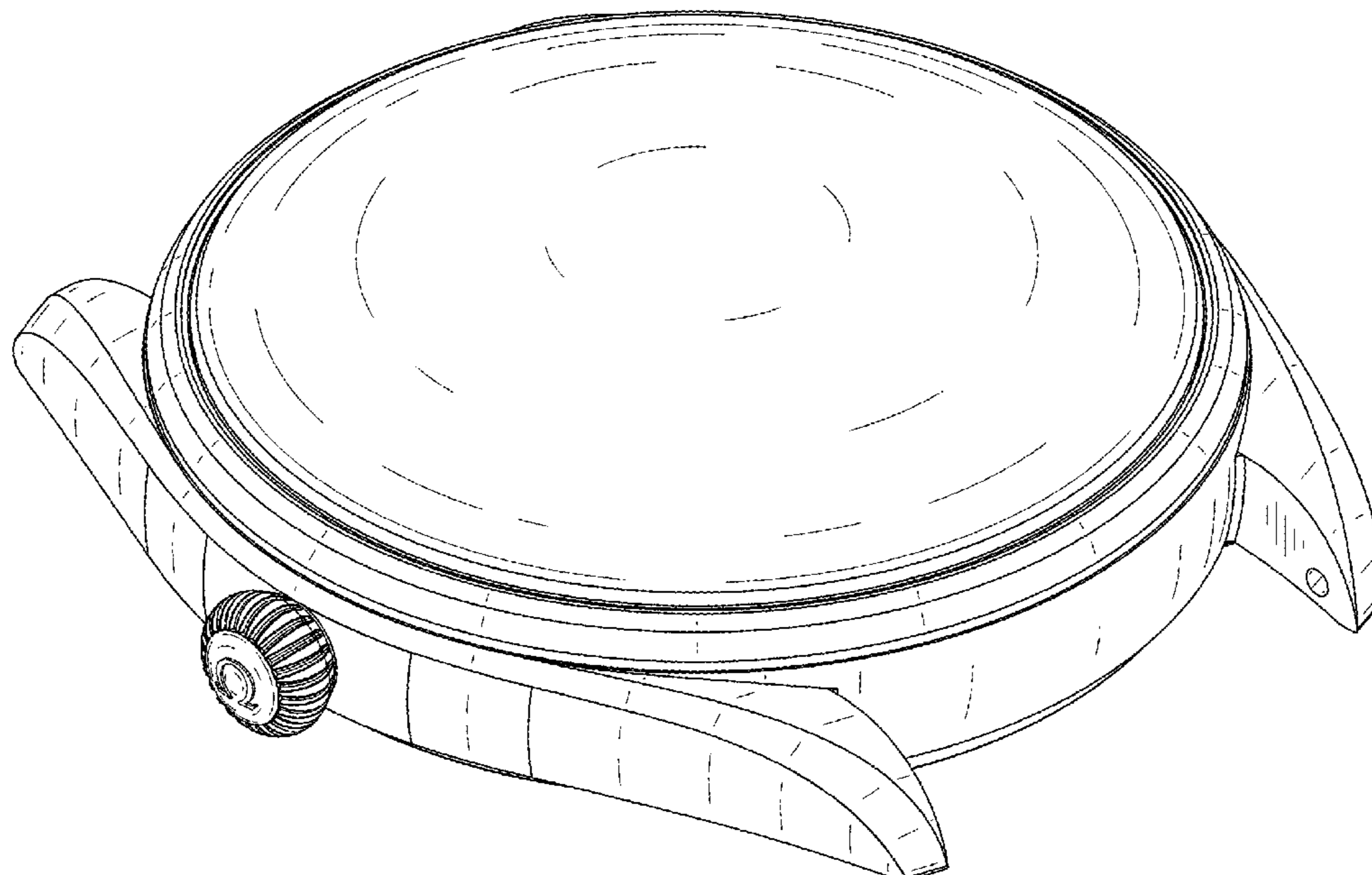

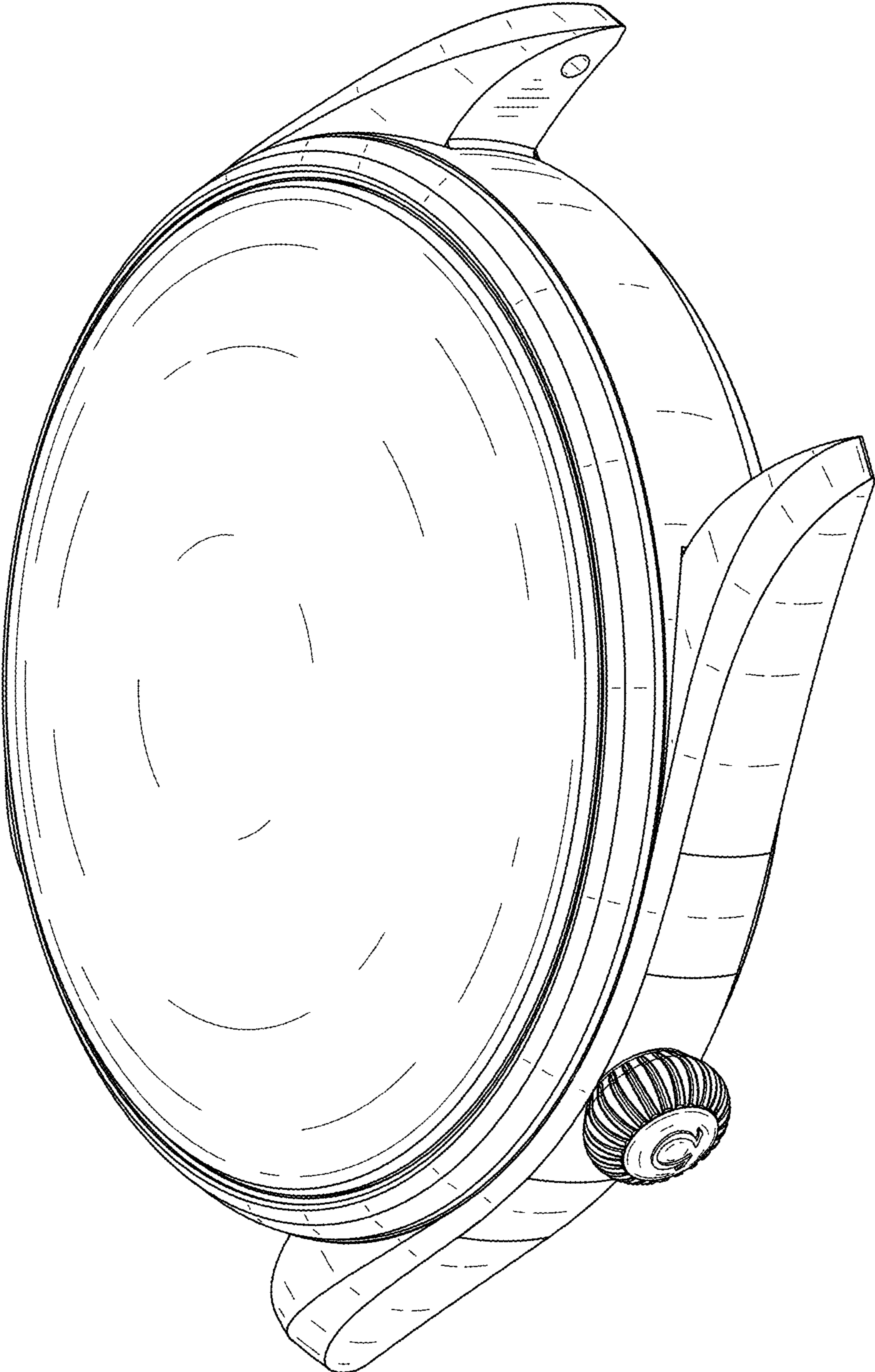

FIG. 1

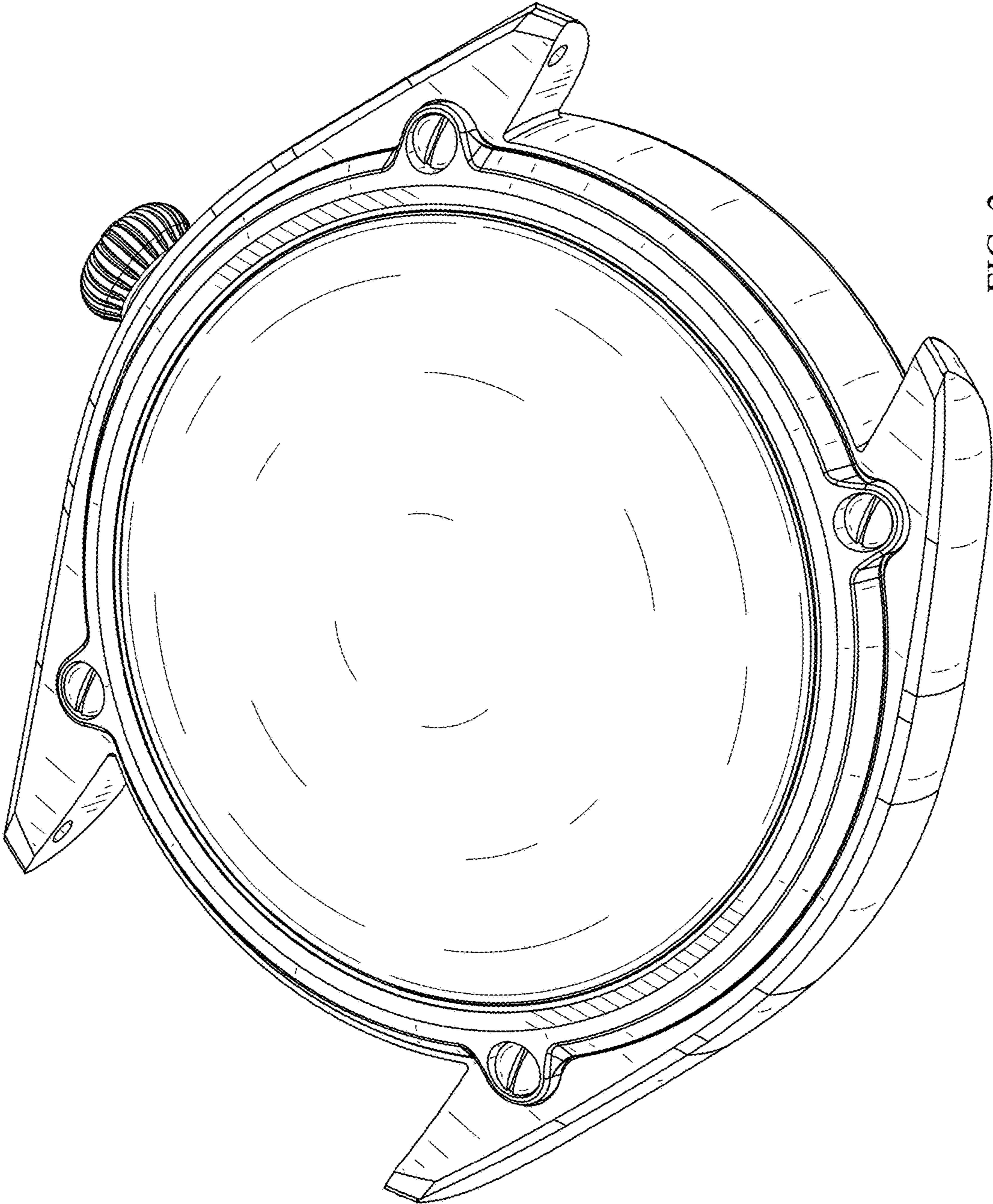

FIG. 2

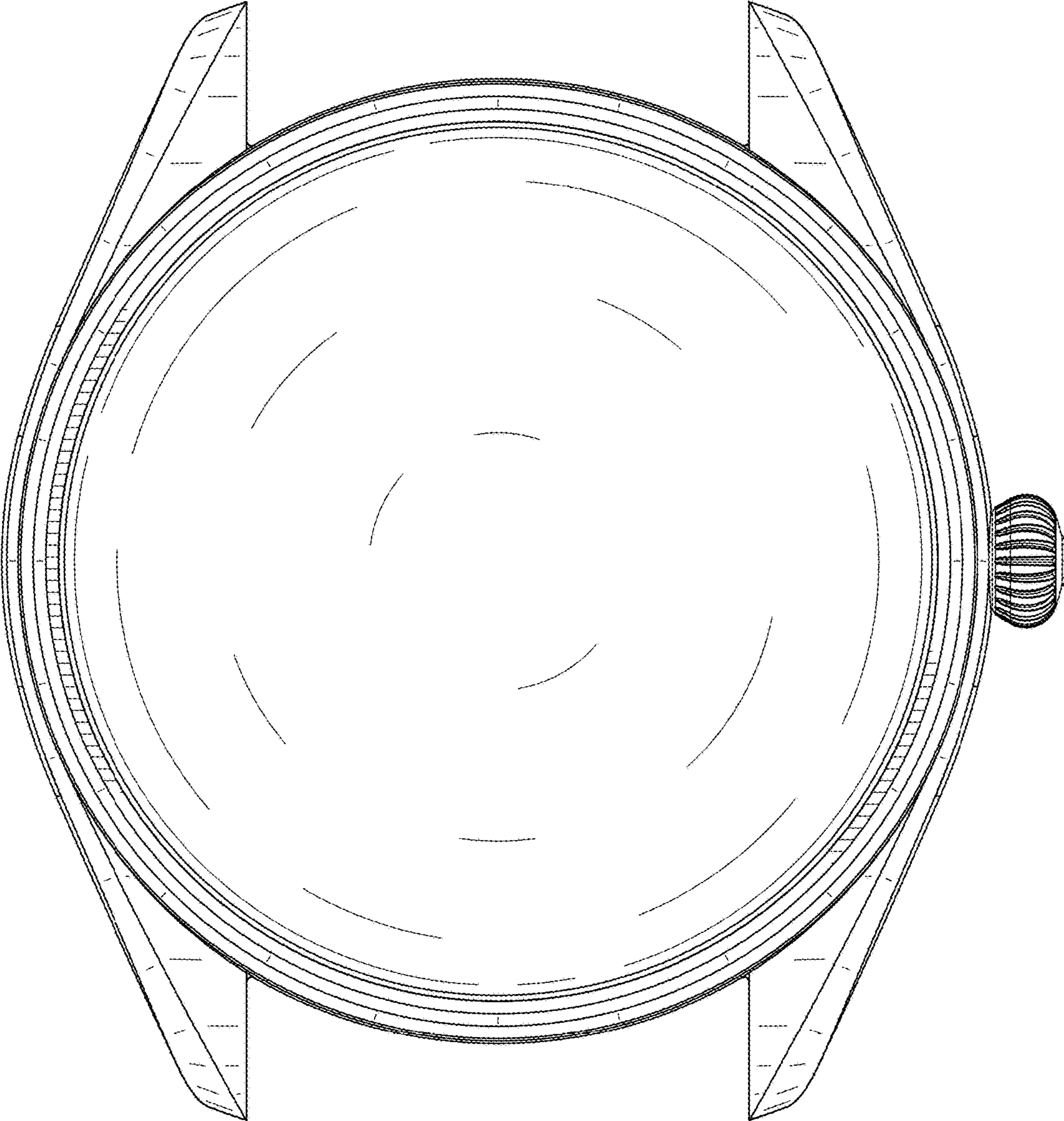

FIG. 3

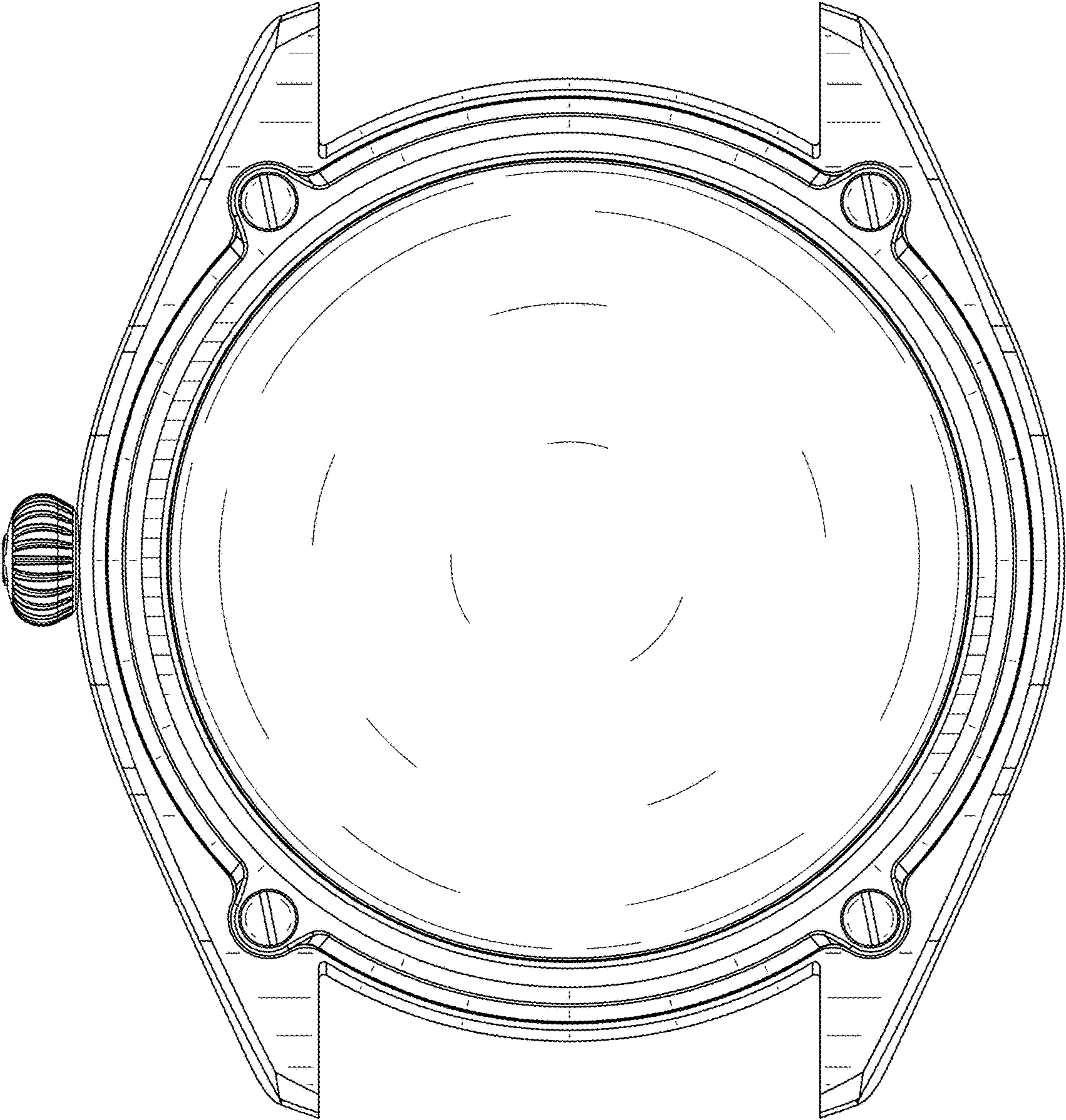

FIG. 4

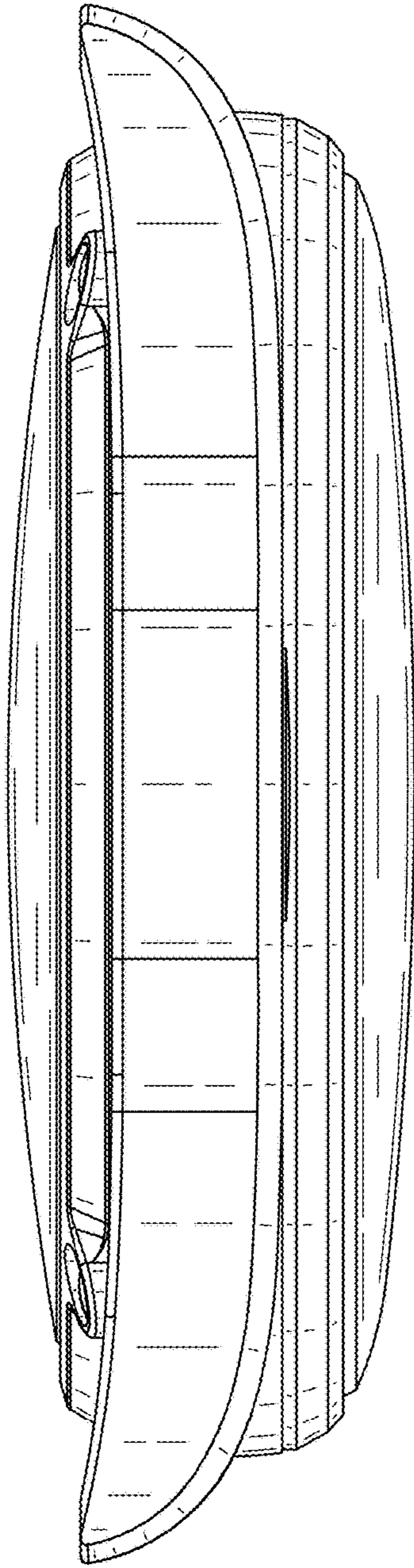

FIG. 5

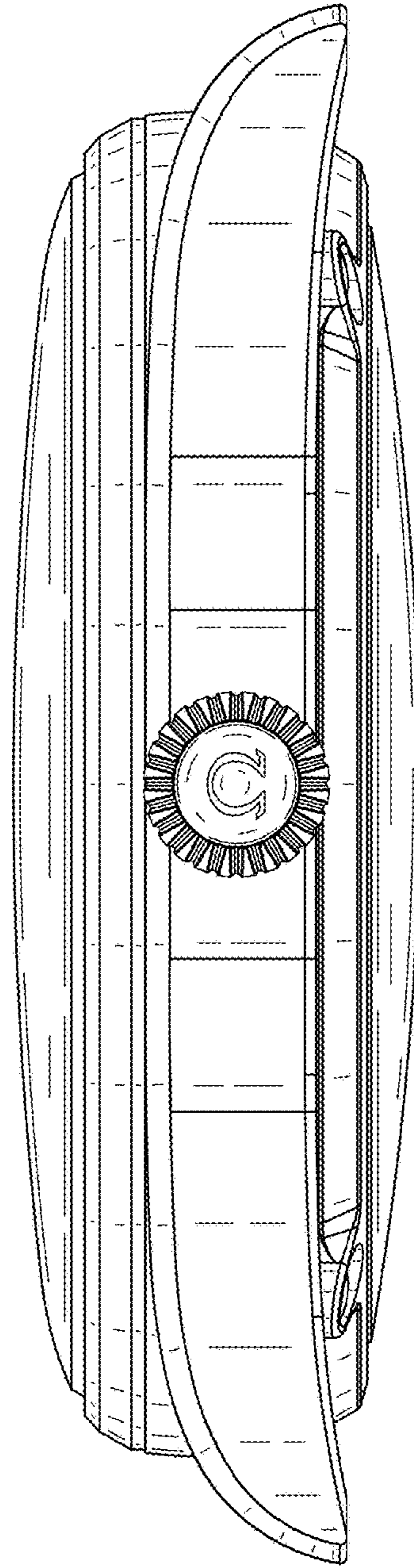

FIG. 6

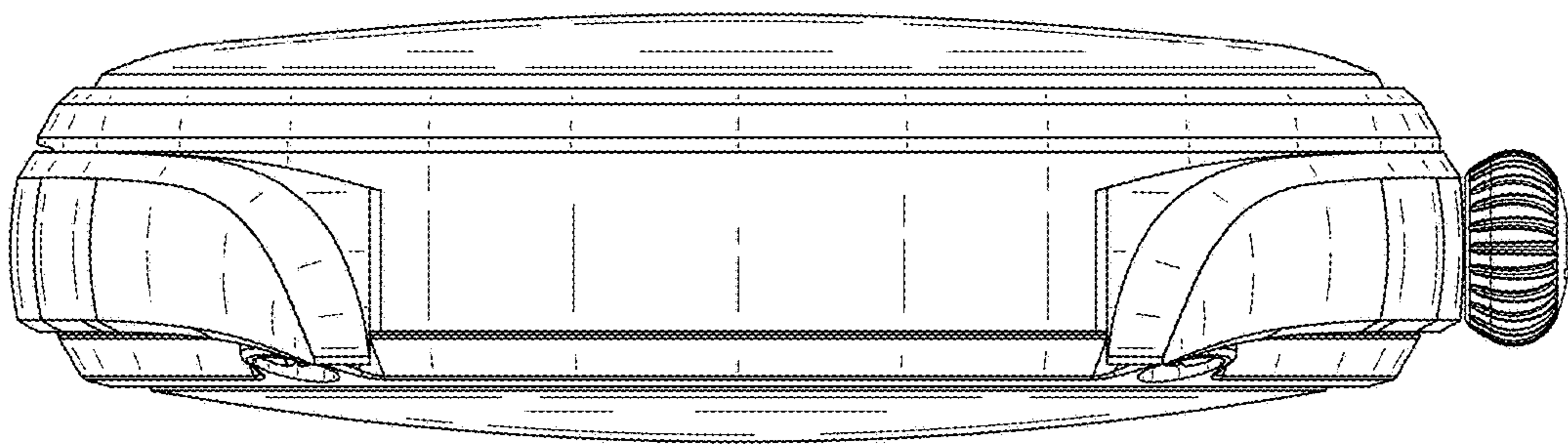

FIG. 7

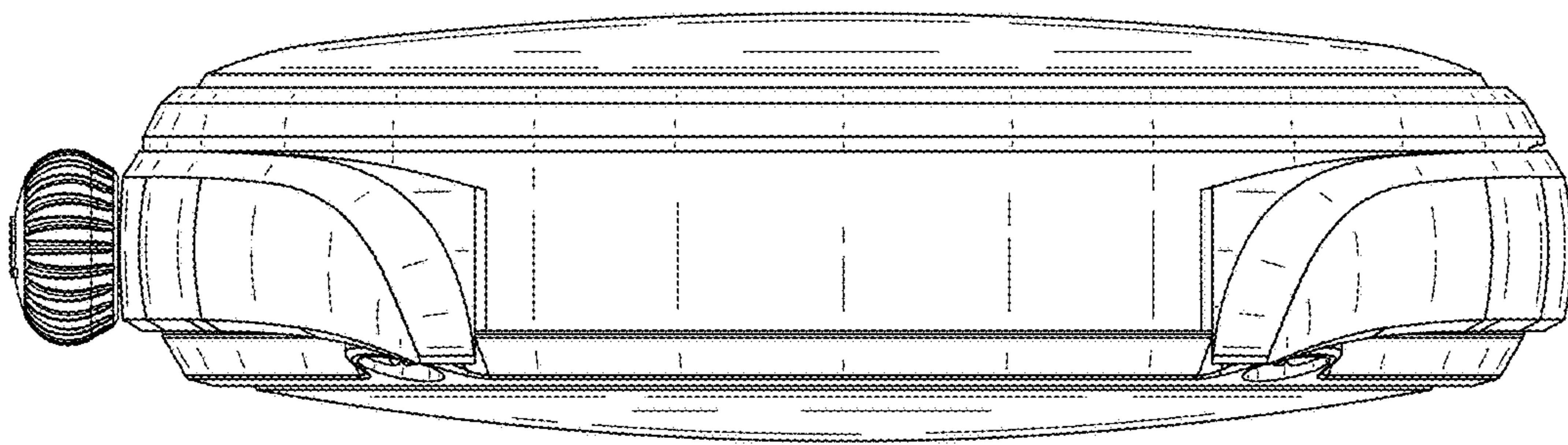

FIG. 8