



US00D823128S

(12) **United States Design Patent** (10) **Patent No.:** **US D823,128 S**
Desdoigts (45) **Date of Patent:** **** *Jul. 17, 2018**

(54) **COSMETICS FLASK**

2034/002; A45D 2034/005; A45D
2034/007

(71) Applicant: **CLARINS S.A.**, Neuilly sur Seine (FR)

See application file for complete search history.

(72) Inventor: **Olivier Desdoigts**, Paris (FR)

(56) **References Cited**

(73) Assignee: **CLARINS S.A.**, Neuilly sur Seine (FR)

U.S. PATENT DOCUMENTS

(*) Notice: This patent is subject to a terminal disclaimer.

842,097	A *	1/1907	Jahn	B05B 11/06 128/200.14
D79,381	S *	9/1929	Norton et al.	D28/91.1
D121,961	S *	8/1940	Martin	D9/453
2,266,767	A *	12/1941	Linden	B05B 11/06 239/349
3,091,367	A *	5/1963	Fredrickson	B65D 83/206 222/182
3,680,738	A *	8/1972	Vos	B65D 83/207 222/136
D242,120	S *	11/1976	Berenstein	D9/688
5,037,006	A *	8/1991	Kock	A47K 5/14 222/190
D463,743	S *	10/2002	de Mourgues	D9/448
D463,746	S *	10/2002	de Baschmakoff	D9/500
D523,350	S *	6/2006	Ohmoto et al.	D9/690
D626,005	S *	10/2010	Duquet	D9/686

(**) Term: **15 Years**

(21) Appl. No.: **29/577,430**

(22) Filed: **Sep. 13, 2016**

(51) **LOC (11) Cl.** **09-01**

(52) **U.S. Cl.**
USPC **D9/692**; D9/690; D9/682

(58) **Field of Classification Search**

USPC D9/600-681, 682-694, 500-505,
D9/723-729, 516-575, 434-436, 439,
D9/440, 444, 445, 447-450;
D28/76-91.1

CPC ... B65D 1/00-1/09; B65D 1/40; B65D 11/04;
B65D 11/16; B65D 23/00; B65D
23/0885; B65D 39/0047; B65D 39/0094;
B65D 83/14; B65D 83/16; B65D 83/20;
B65D 83/201; B65D 83/205; B65D
83/206; B65D 83/207; B65D 83/22;
B65D 83/28; B65D 83/285; B65D 83/30;
B65D 83/32; B65D 83/36; B65D 83/38;
B65D 83/384; B65D 83/386; B65D
83/388; B65D 83/40; B65D 83/75; B65D
83/753; B65D 2501/00; B65D 2501/0009;
B65D 2501/0063; B65D 2501/0072;
B05B 11/00-11/3098; A45D 34/00; A45D
34/02; A45D 34/04; A45D 34/041; A45D

(Continued)

FOREIGN PATENT DOCUMENTS

CN 3280666 * 3/2003

Primary Examiner — Catherine A Tuttle
(74) *Attorney, Agent, or Firm* — Avery N. Goldstein;
Blue Filament Law, PLLC

(57) **CLAIM**

The ornamental design for a cosmetics flask, as shown and described.

DESCRIPTION

FIG. 1 is a front view of a cosmetics flask showing my new design;
FIG. 2 is a rear view thereof;
FIG. 3 is a top view thereof;
FIG. 4 is a bottom view thereof;
FIG. 5 is an elevated first perspective view thereof; and,
FIG. 6 is an elevated second perspective view thereof.

(Continued)

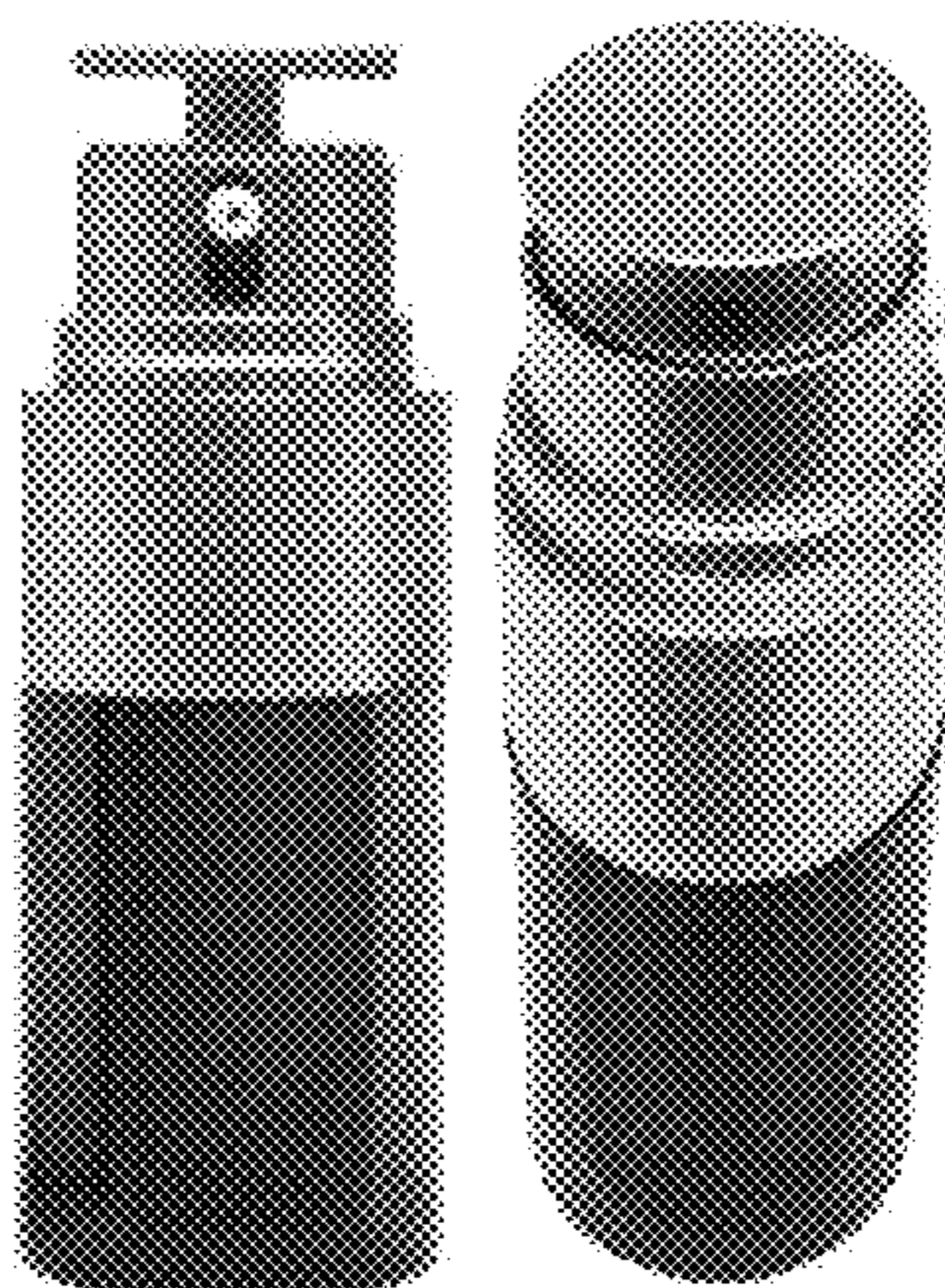

The appearance within the bottom outline shown in FIG. 4 forms no part of the claimed design.

1 Claim, 1 Drawing Sheet

(56) **References Cited**

U.S. PATENT DOCUMENTS

D633,389	S *	3/2011	Jorgensen	D9/454
D669,366	S *	10/2012	Baron	D9/692
D679,998	S *	4/2013	Kim	D9/447
D695,131	S *	12/2013	Mansau	D9/690
D716,666	S *	11/2014	Park	D9/690
D717,664	S *	11/2014	Van Handel	D9/682
D720,627	S *	1/2015	Chen	D9/688
2001/0004091	A1 *	6/2001	Wintering	B05B 9/0426 239/333
2009/0120963	A1 *	5/2009	Bae	B05B 11/0032 222/153.13
2012/0111896	A1 *	5/2012	Lee	B05B 11/0032 222/321.3
2014/0116280	A1 *	5/2014	Berger	B65D 83/207 102/368
2015/0342411	A1 *	12/2015	Son	B05B 11/0081 366/130

* cited by examiner

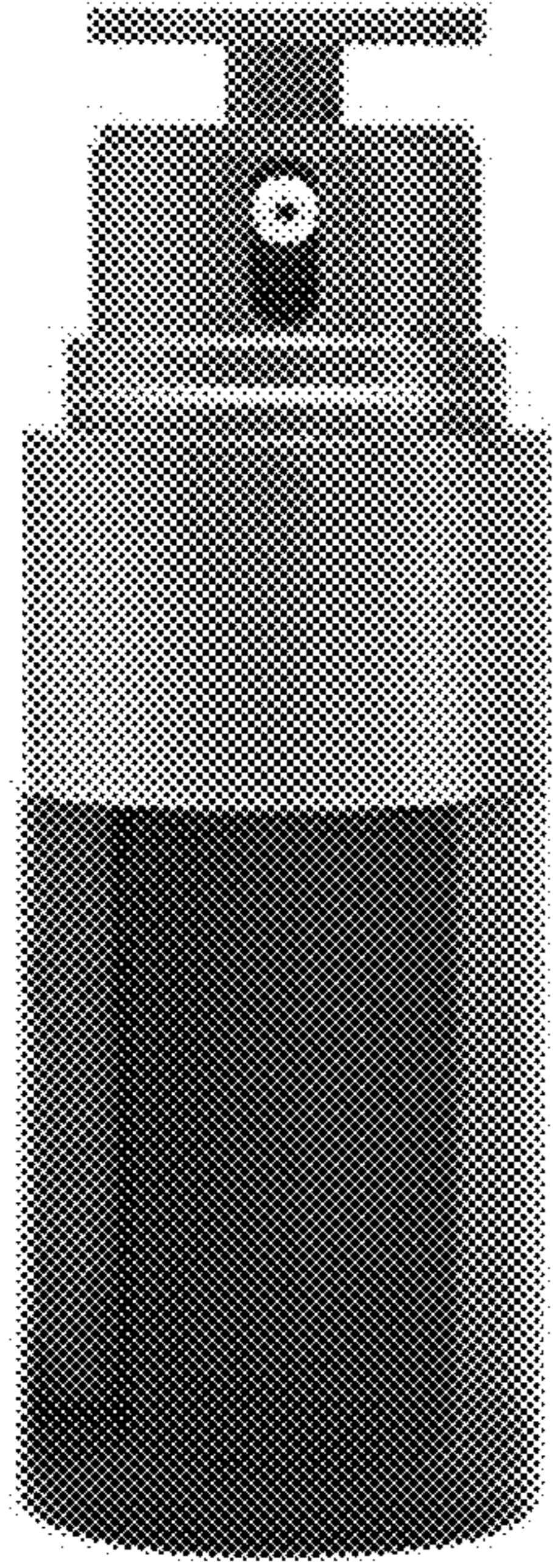

FIG. 1

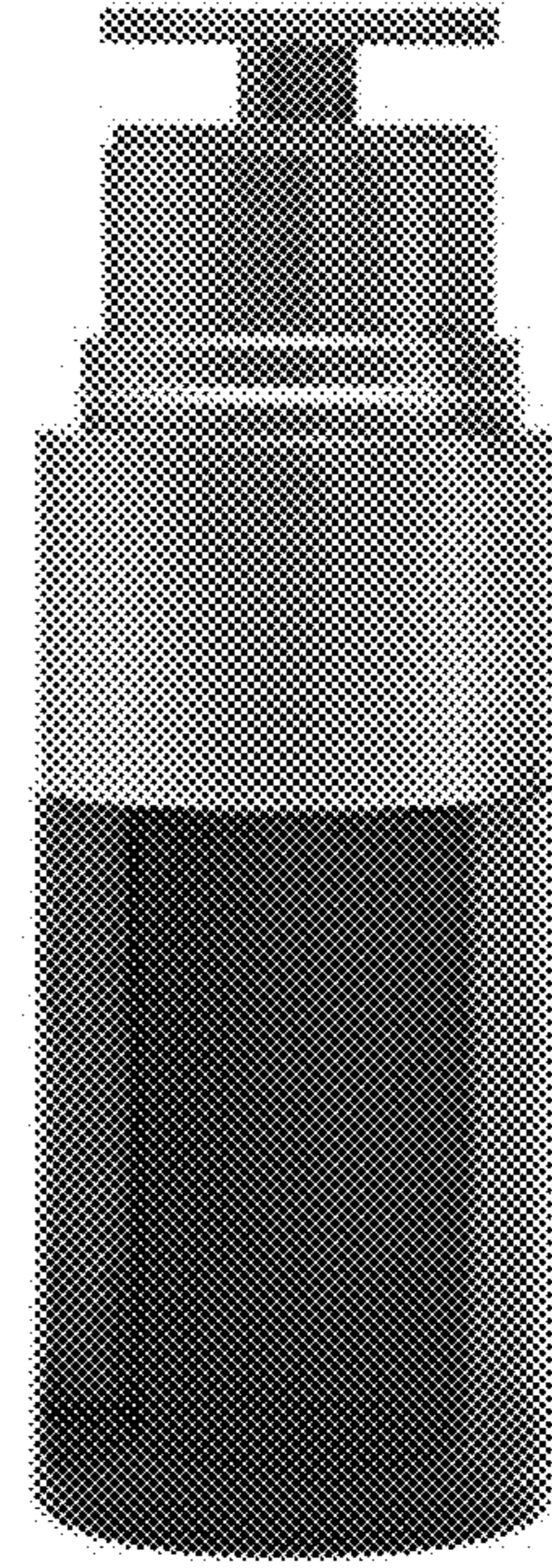

FIG. 2

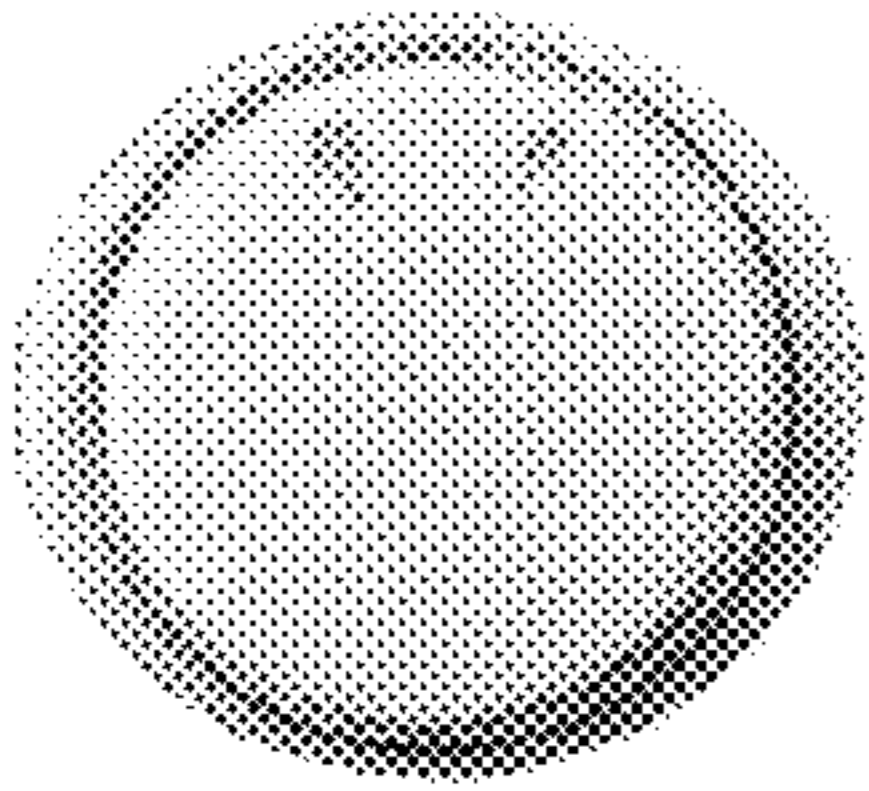

FIG. 3

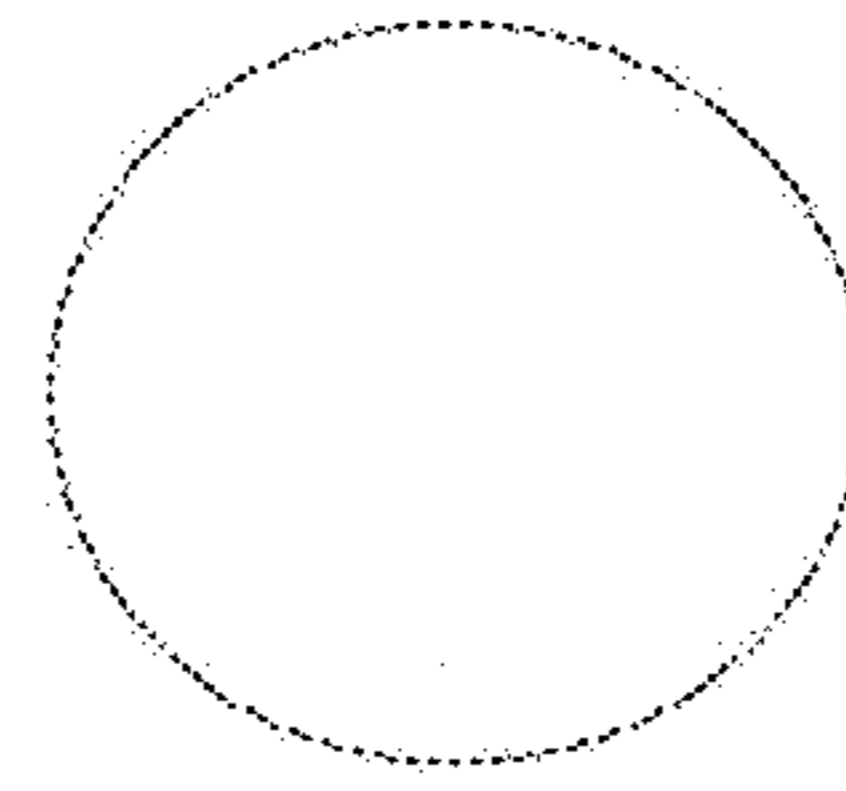

FIG. 4

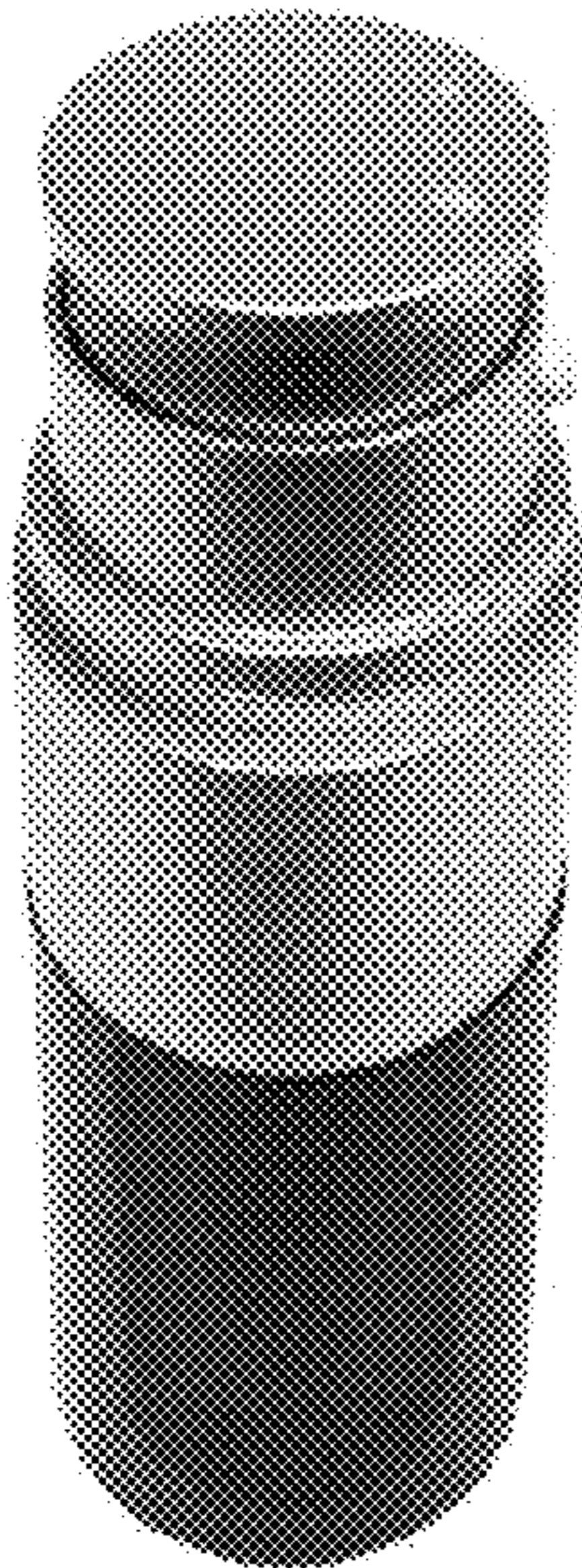

FIG. 5

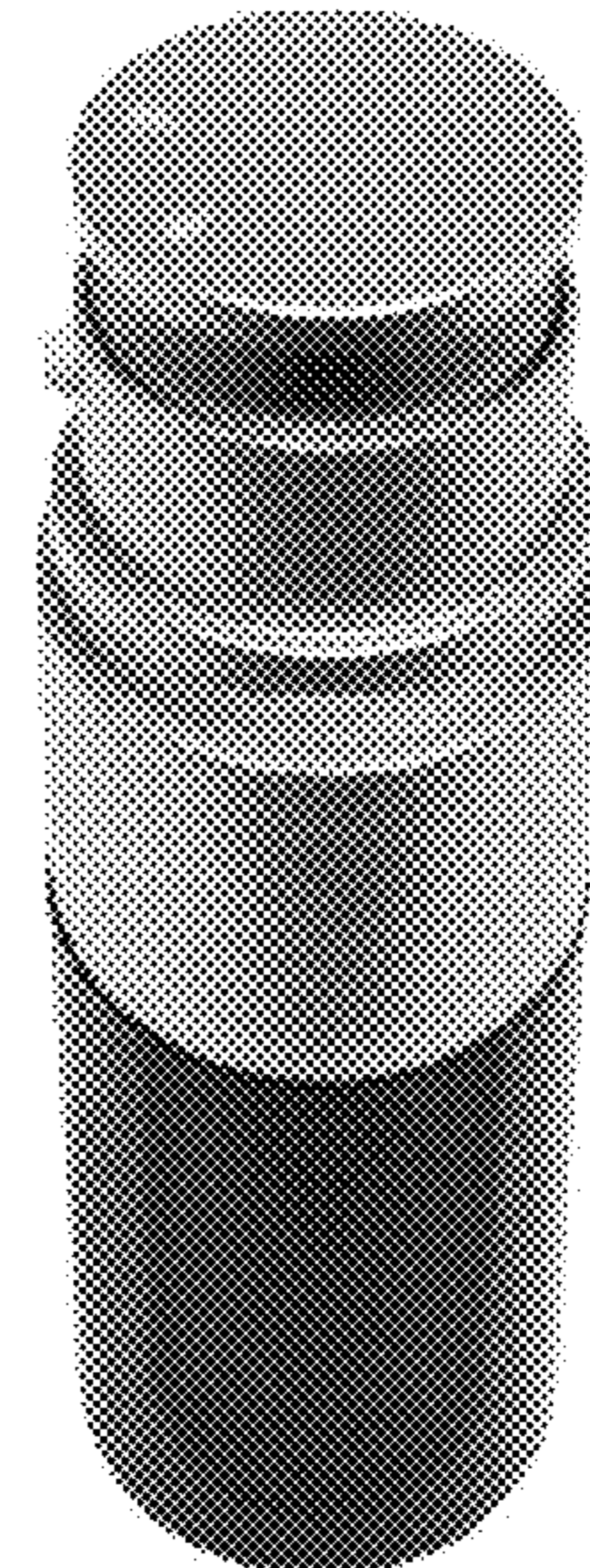

FIG. 6