



US00D823045S

(12) **United States Design Patent**  
**Barnard**

(10) **Patent No.:** **US D823,045 S**  
(45) **Date of Patent:** **\*\* Jul. 17, 2018**

(54) **MICROWAVE OVEN**

(71) Applicants: **GUANGDONG MIDEA KITCHEN APPLIANCES MANUFACTURING CO., LTD.**, Foshan (CN); **MIDEA GROUP CO., LTD.**, Foshan (CN)

(72) Inventor: **Pierce James Barnard**, Foshan (CN)

(73) Assignees: **GUANGDONG MIDEA KITCHEN APPLIANCES MANUFACTURING CO., LTD.**, Foshan (CN); **MIDEA GROUP CO., LTD.**, Foshan (CN)

(\*\*) Term: **15 Years**

(21) Appl. No.: **29/615,355**

(22) Filed: **Aug. 28, 2017**

(30) **Foreign Application Priority Data**

Jul. 21, 2017 (CN) ..... 2017 3 0325664

(51) **LOC (11) Cl.** ..... **07-02**

(52) **U.S. Cl.**  
USPC ..... **D7/351**

(58) **Field of Classification Search**  
USPC ..... D7/323, 339, 340, 341, 347, 348, 349,  
D7/351, 350.1, 350.2, 350.3, 350.4, 402,  
D7/403, 405  
CPC .. A21B 2/00; A21B 3/02; F24C 15/02; H05B  
1/0263; H05B 2206/044; H05B 6/763;  
H05B 6/76; H05B 6/802; H05B 6/808;  
H05B 6/64

See application file for complete search history.

(56) **References Cited**

**U.S. PATENT DOCUMENTS**

D535,141 S \* 1/2007 Lee ..... D7/351  
D535,516 S \* 1/2007 Lee ..... D7/351  
D540,108 S \* 4/2007 Kim ..... D7/351  
D615,804 S \* 5/2010 Baek ..... D7/351  
D626,370 S \* 11/2010 Baek ..... D7/351

D633,328 S \* 3/2011 Shin ..... D7/351  
D669,298 S \* 10/2012 Tonon ..... D7/350.1  
D708,469 S \* 7/2014 Kim ..... D7/351  
D712,694 S \* 9/2014 Kim ..... D7/351  
D717,580 S \* 11/2014 Bryant ..... D7/351  
D761,620 S \* 7/2016 Kim ..... D7/405  
D772,639 S \* 11/2016 Kim ..... D7/351  
D772,646 S \* 11/2016 Kim ..... D7/405

**OTHER PUBLICATIONS**

Amazon. <URL: [\\* cited by examiner](https://www.amazon.com/Dacor-DMW2420S-Distinctive-Microwave-Stainless/dp/B004RT4J16/ref=sr_1_27?s=kitchen&ie=UTF8&qid=1525353313&sr=1-27&keywords=microwave&refinements=p_36%3A1253527011.> https://www.amazon.com/Dacor-DMW2420S-Distinctive-Microwave-Stainless/dp/B004RT4J16/ref=sr_1_27?s=kitchen&ie=UTF8&qid=1525353313&sr=1-27&keywords=microwave&refinements=p_36%3A1253527011.> Jan. 27, 2011. Dacor DMW2420S Microwave.*</p></div>
<div data-bbox=)

*Primary Examiner* — Thomas Johannes

*Assistant Examiner* — Lauren McVey

(74) *Attorney, Agent, or Firm* — Kilpatrick Townsend & Stockton LLP

(57) **CLAIM**

The ornamental design for a microwave oven, as shown and described.

**DESCRIPTION**

FIG. 1 is a perspective view of a microwave oven, showing our new design;  
FIG. 2 is a front view thereof;  
FIG. 3 is a back view thereof;  
FIG. 4 is a right side view thereof;  
FIG. 5 is a left side view thereof;  
FIG. 6 is a top view thereof; and,  
FIG. 7 is a bottom view thereof.  
The broken lines immediately adjacent to the shaded areas represent the bounds of the claimed design while all other broken lines are directed to environment and are for illustrative purposes only; the broken lines form no part of the claimed design.

**1 Claim, 7 Drawing Sheets**

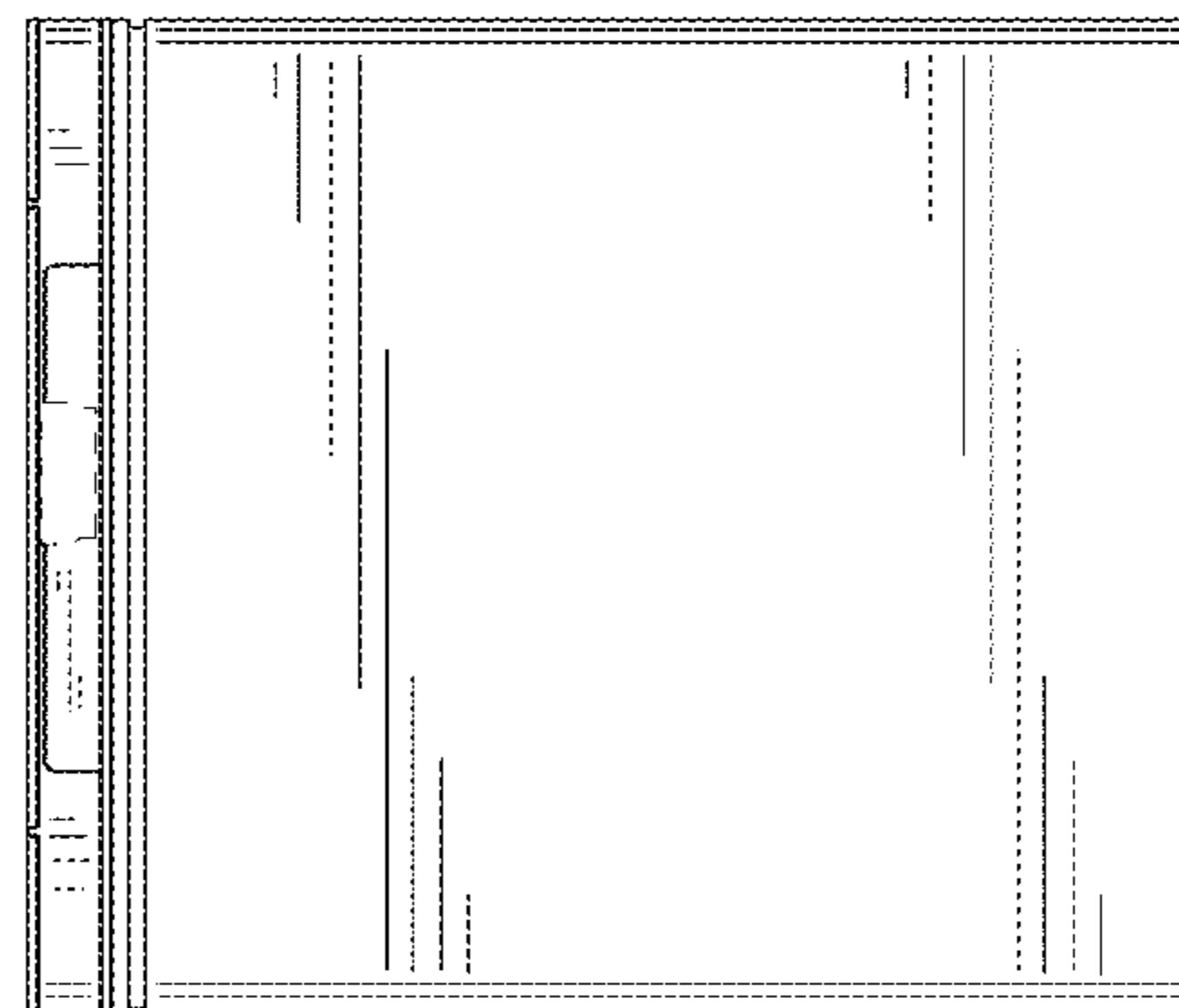
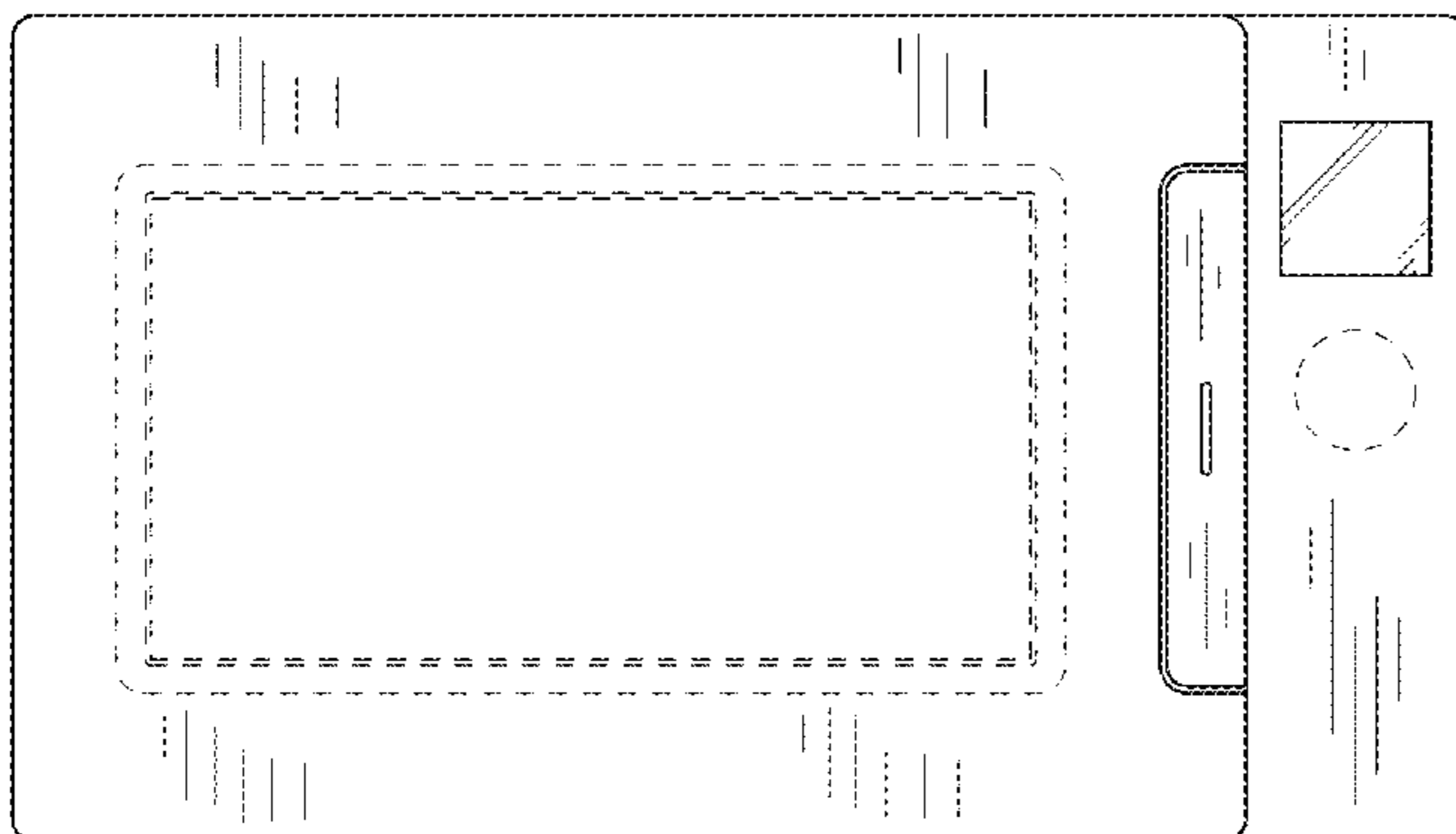

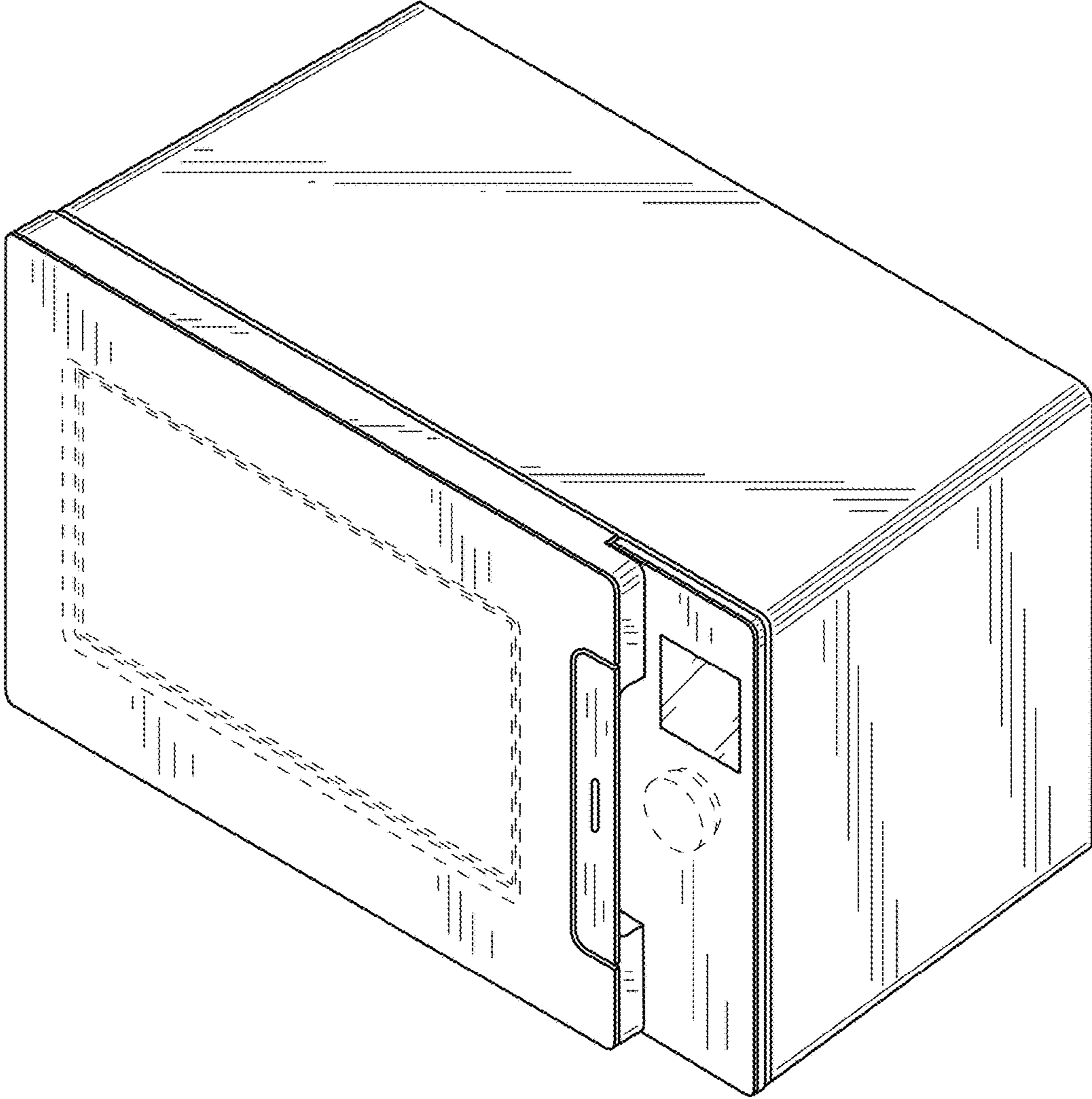

FIG.1

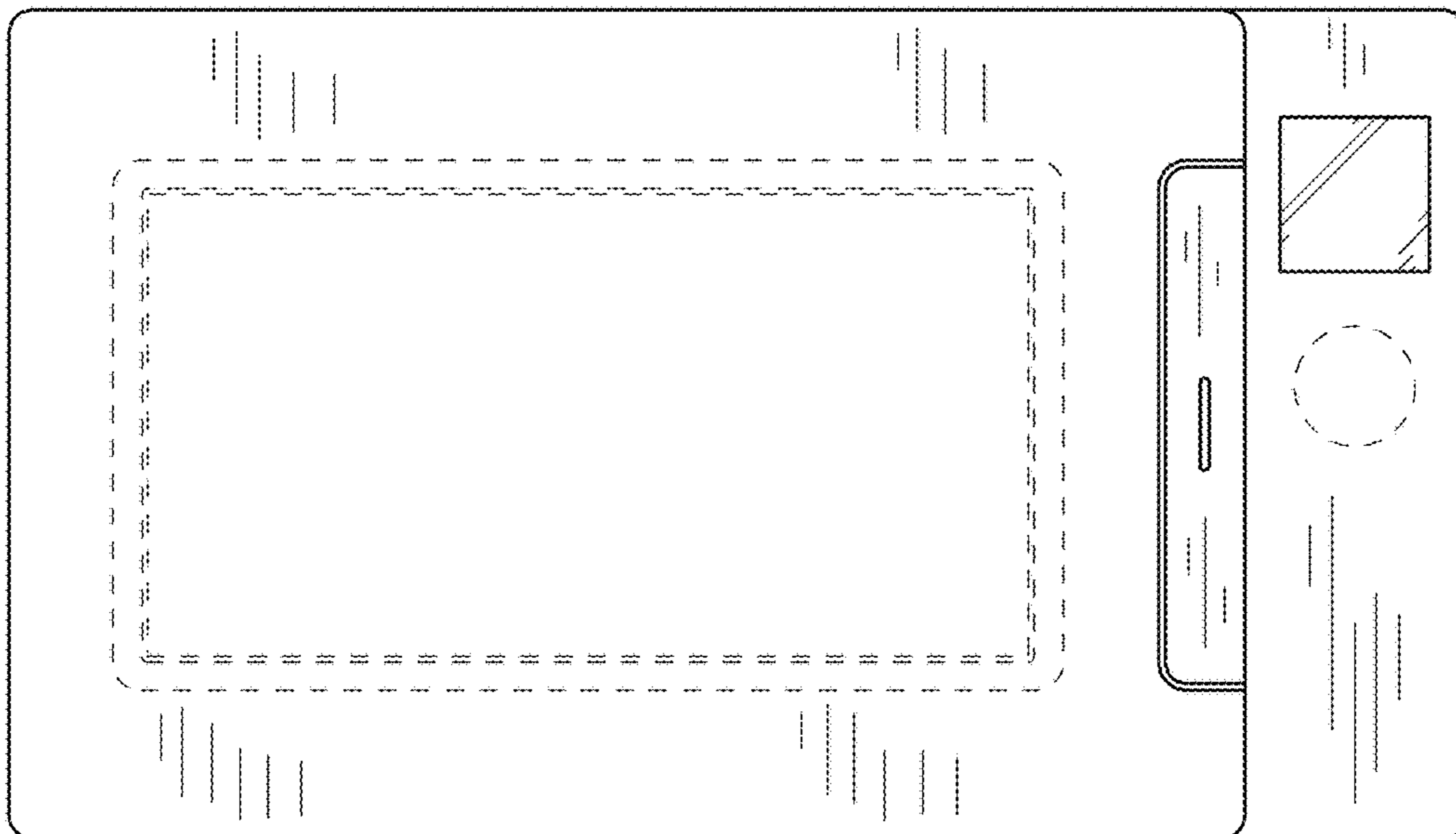

FIG.2

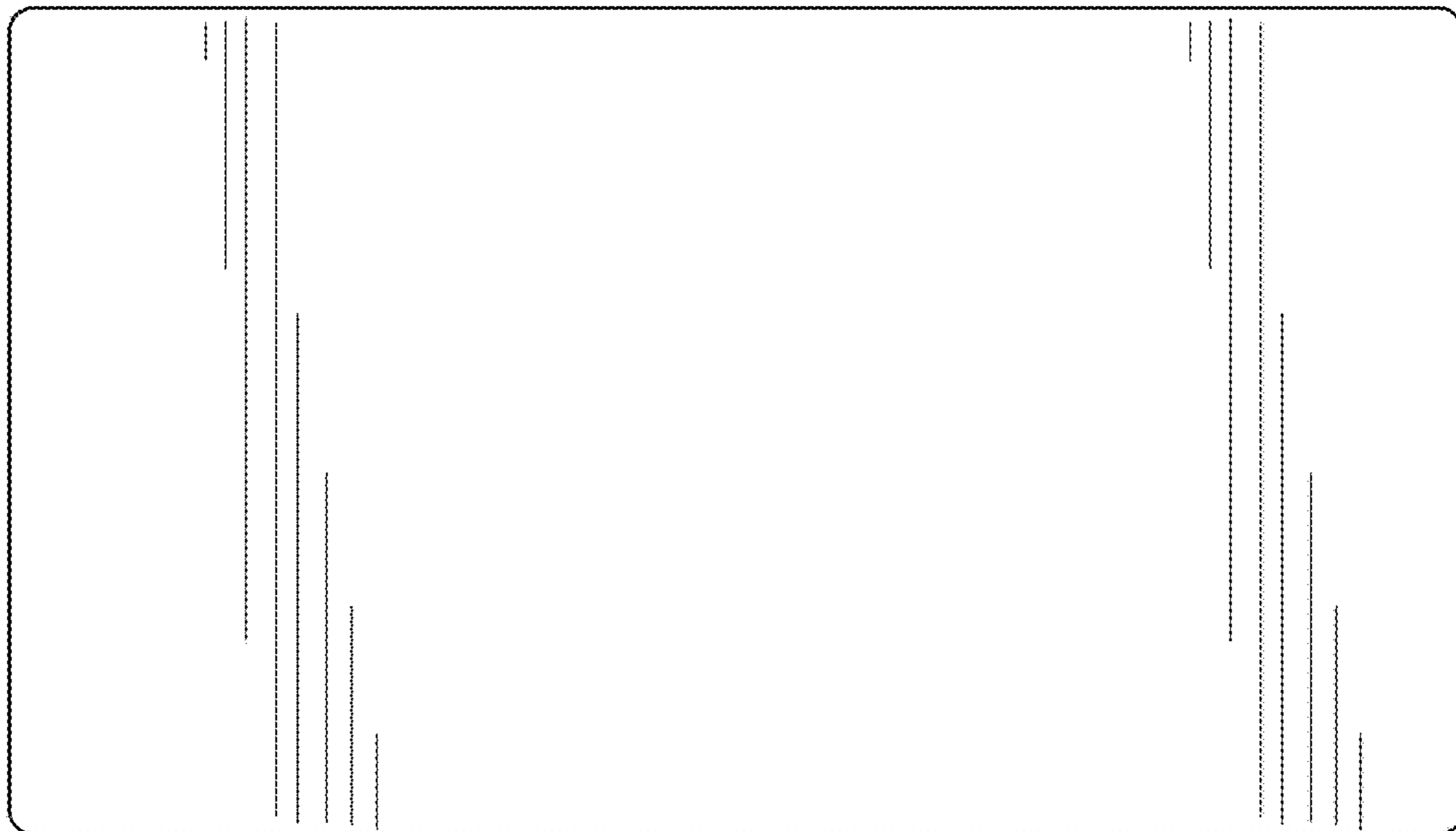

FIG.3

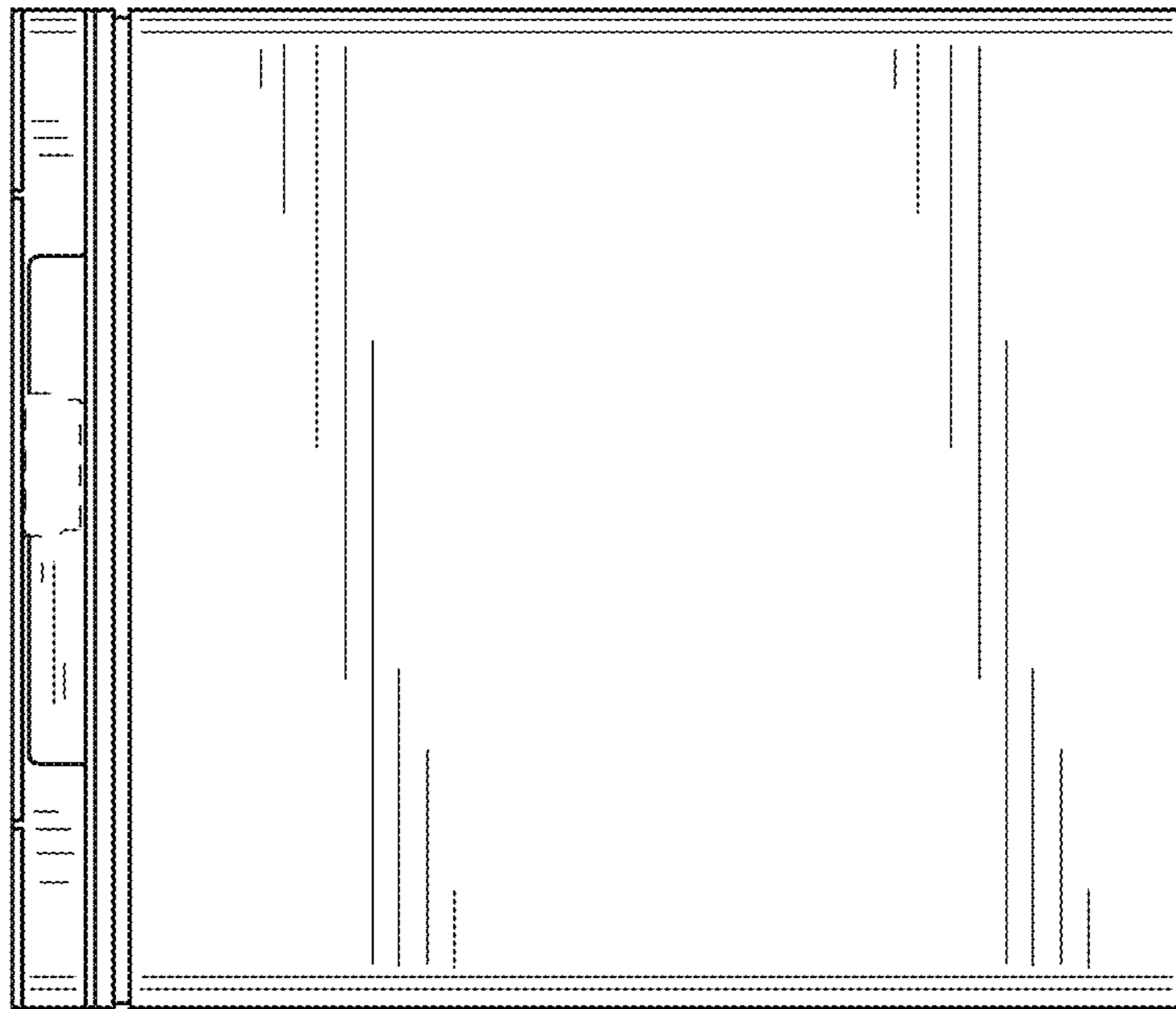

FIG.4

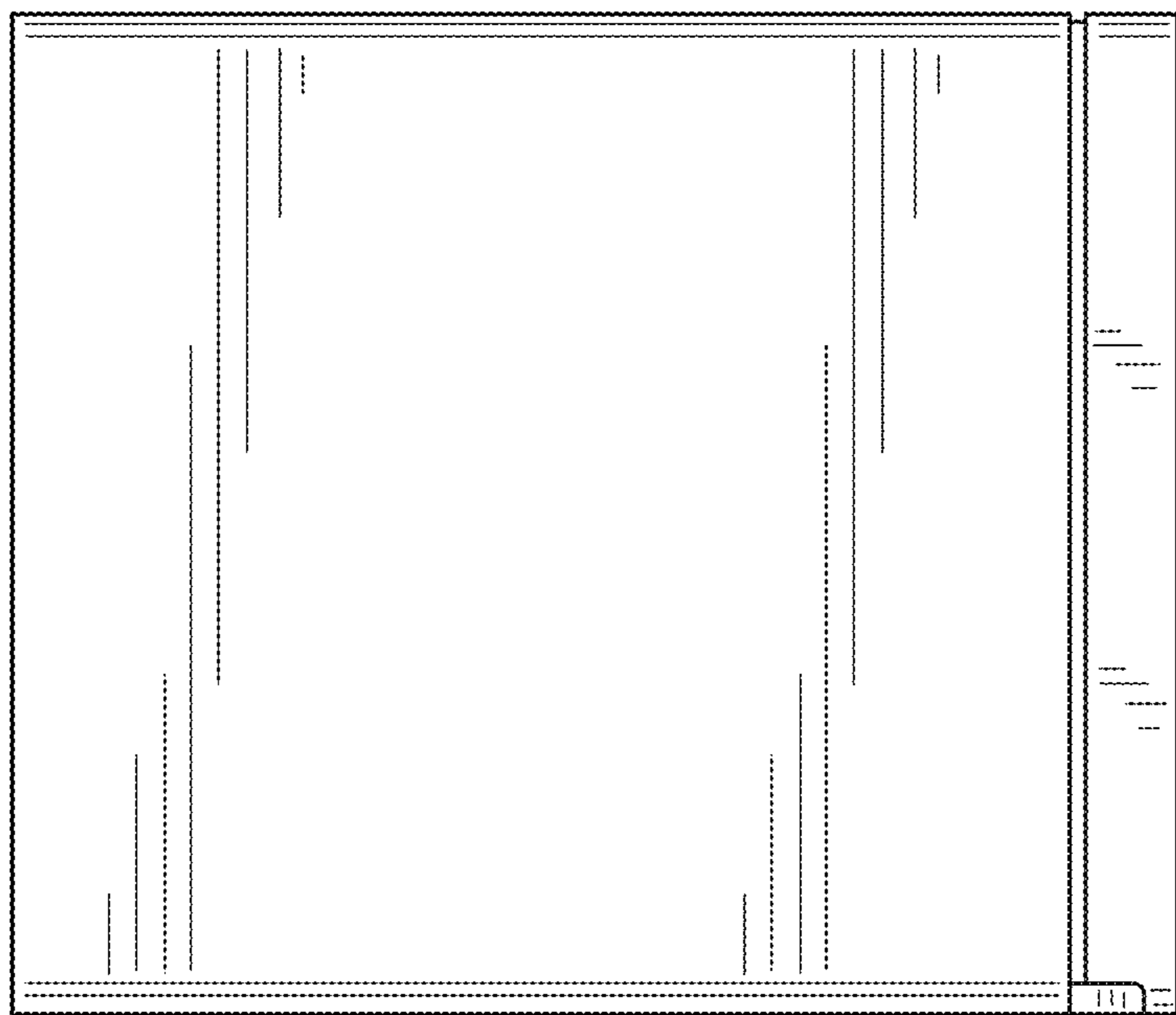

FIG.5

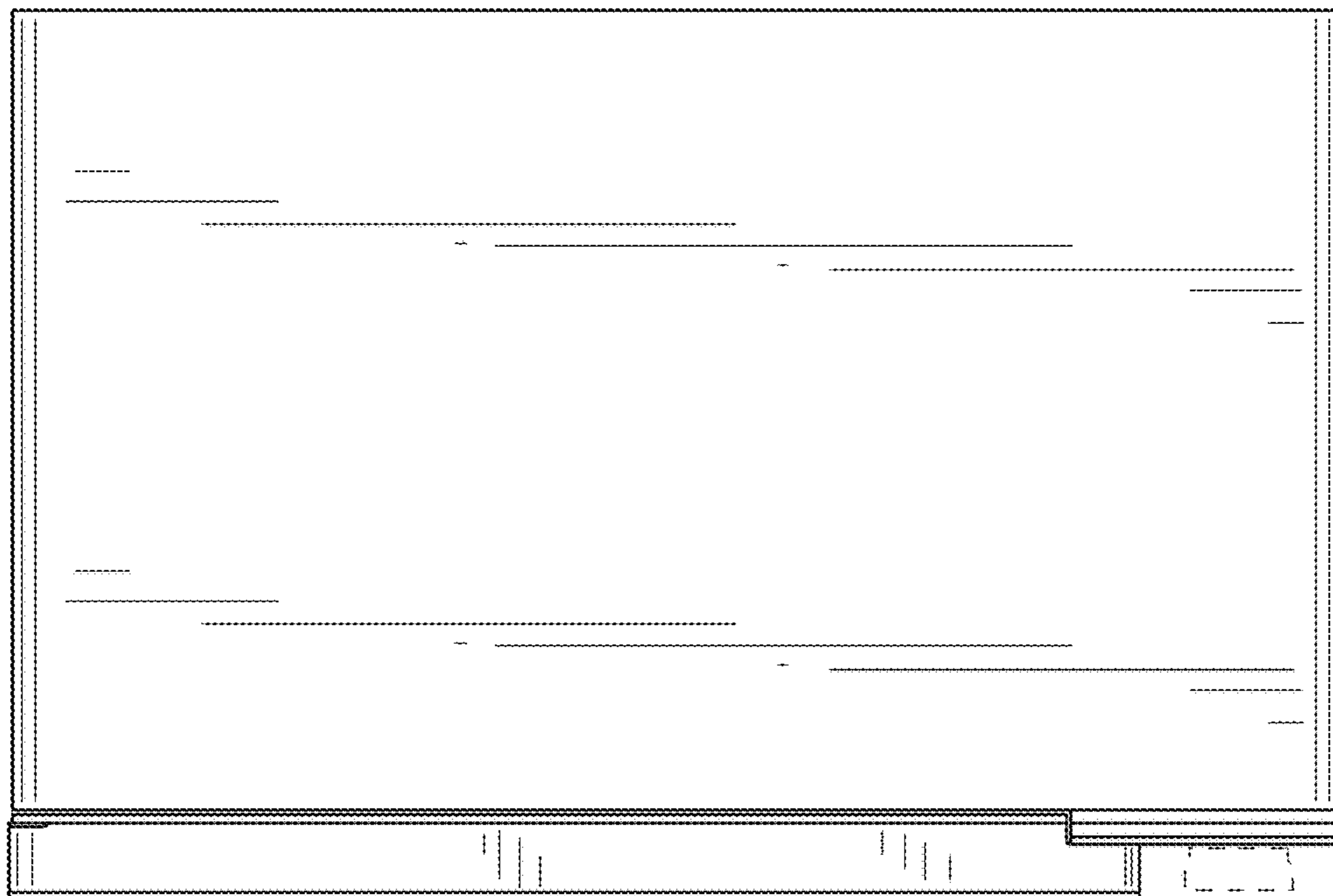

FIG. 6

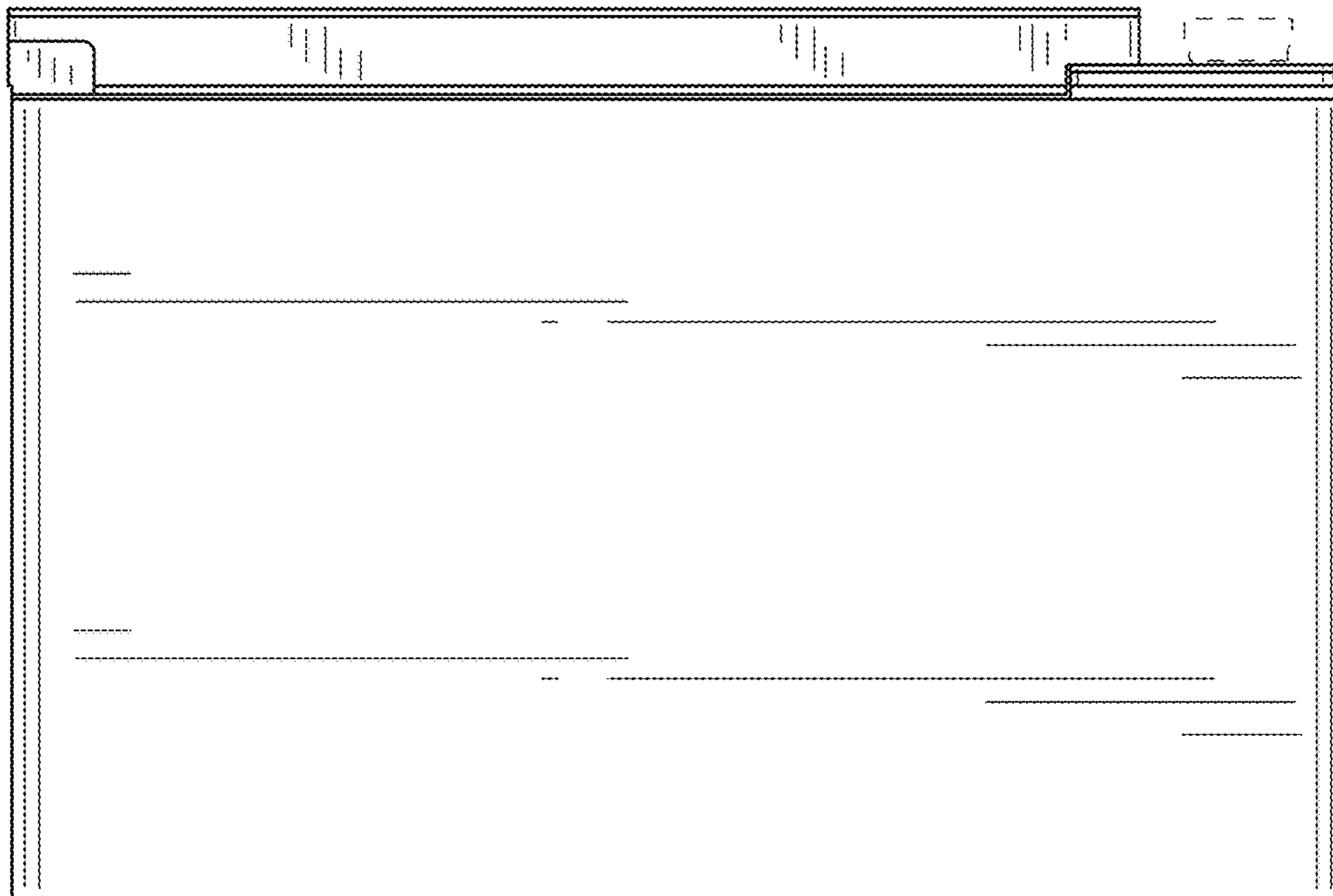

FIG.7