



US00D823044S

(12) **United States Design Patent**
Barnard

(10) **Patent No.:** **US D823,044 S**
(45) **Date of Patent:** **** Jul. 17, 2018**

(54) **MICROWAVE OVEN**

(71) Applicants: **GUANGDONG MIDEA KITCHEN APPLIANCES MANUFACTURING CO., LTD.**, Foshan (CN); **MIDEA GROUP CO., LTD.**, Foshan (CN)

(72) Inventor: **Pierce James Barnard**, Foshan (CN)

(73) Assignees: **GUANGDONG MIDEA KITCHEN APPLIANCES MANUFACTURING CO., LTD.**, Foshan (CN); **MIDEA GROUP CO., LTD.**, Foshan (CN)

(**) Term: **15 Years**

(21) Appl. No.: **29/615,353**

(22) Filed: **Aug. 28, 2017**

(30) **Foreign Application Priority Data**

Jul. 21, 2017 (CN) 2017 3 0325725

(51) **LOC (11) Cl.** **07-02**

(52) **U.S. Cl.**
USPC **D7/351**

(58) **Field of Classification Search**
USPC D7/323, 339, 340, 341, 347, 348, 349, D7/351, 350.1, 350.2, 350.3, 350.4, 402, D7/403, 405
CPC .. A21B 2/00; A21B 3/02; F24C 15/02; H05B 1/0263; H05B 2206/044; H05B 6/763; H05B 6/76; H05B 6/802; H05B 6/808; H05B 6/64

See application file for complete search history.

(56) **References Cited**

U.S. PATENT DOCUMENTS

D435,999 S * 1/2001 Noda D7/351
D561,529 S * 2/2008 Suh D7/351
D576,834 S * 9/2008 Shin D7/351
D576,835 S * 9/2008 Shin D7/351
D607,264 S * 1/2010 Lee D7/351
D657,607 S * 4/2012 Ohmae D7/351

D665,219 S * 8/2012 Ohmae D7/351
D707,074 S * 6/2014 Shin D7/351
D741,639 S * 10/2015 Kim D7/351
D769,669 S * 10/2016 Kim D7/351

(Continued)

FOREIGN PATENT DOCUMENTS

JP 10253063 A * 9/1998 H05B 6/745

OTHER PUBLICATIONS

Amazon. <URL: https://www.amazon.com/Sharp-Microwaves-ZSMC1655BS-Countertop-Microwave/dp/B01N31DJUU/ref=sr_1_1?ie=UTF8&qid=1525111590&sr=8-1&keywords=Sharp+ZSMC1655BS+1.6+Cu+Ft+Microwave%2C+Stainless+Steel.> Jan. 6, 2017. Sharp ZSMC1655BS 1.6 Cu Ft Microwave, Stainless Steel.*

Primary Examiner — Thomas Johannes

Assistant Examiner — Lauren McVey

(74) *Attorney, Agent, or Firm* — Kilpatrick Townsend & Stockton LLP

(57) **CLAIM**

The ornamental design for a microwave oven, as shown and described.

DESCRIPTION

FIG. 1 is a perspective view of a microwave oven, showing our new design;
FIG. 2 is a front elevation view thereof;
FIG. 3 is a rear elevation view thereof;
FIG. 4 is a right side elevation view thereof;
FIG. 5 is a left side elevation view thereof;
FIG. 6 is a top plan view thereof; and,
FIG. 7 is a bottom plan view thereof.
The broken lines immediately adjacent to the shaded areas represent the bounds of the claimed design while all other broken lines are directed to environment and are for illustrative purposes only; the broken lines form no part of the claimed design.

1 Claim, 7 Drawing Sheets

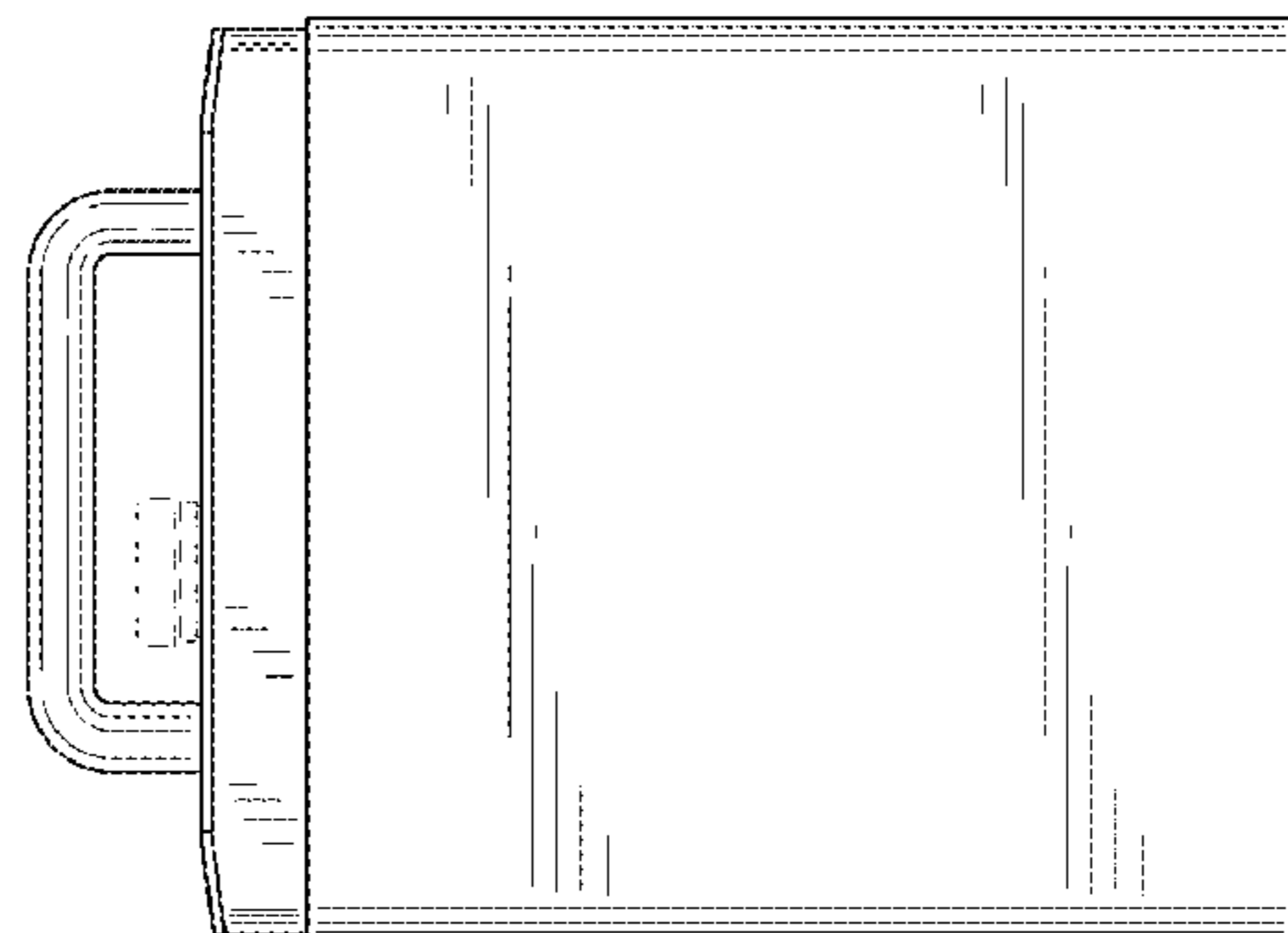
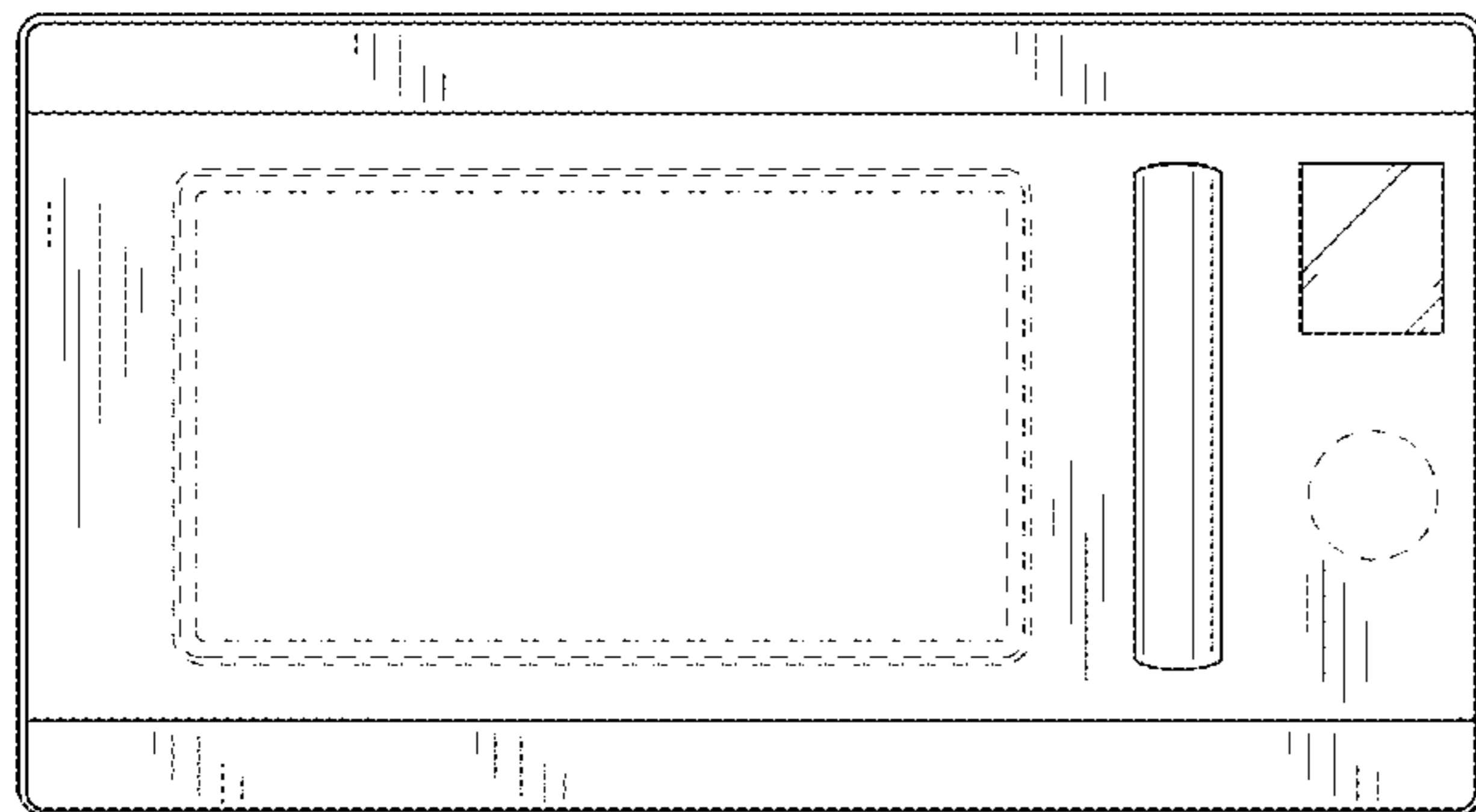

(56)

References Cited

U.S. PATENT DOCUMENTS

D773,235 S * 12/2016 Chung D7/351
D781,638 S * 3/2017 Chung D7/351
D813,592 S * 3/2018 Jeon D7/351

* cited by examiner

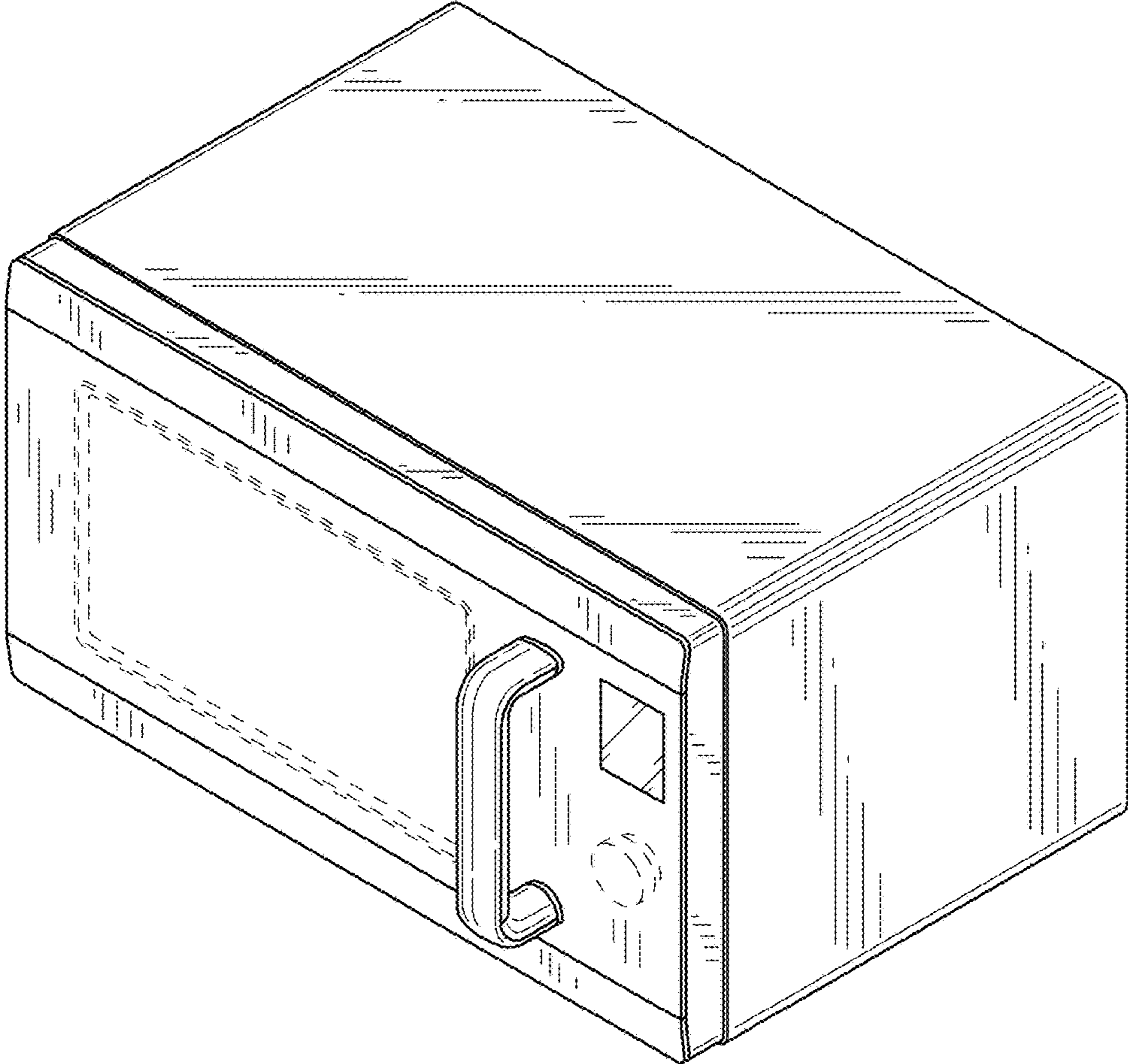

FIG.1

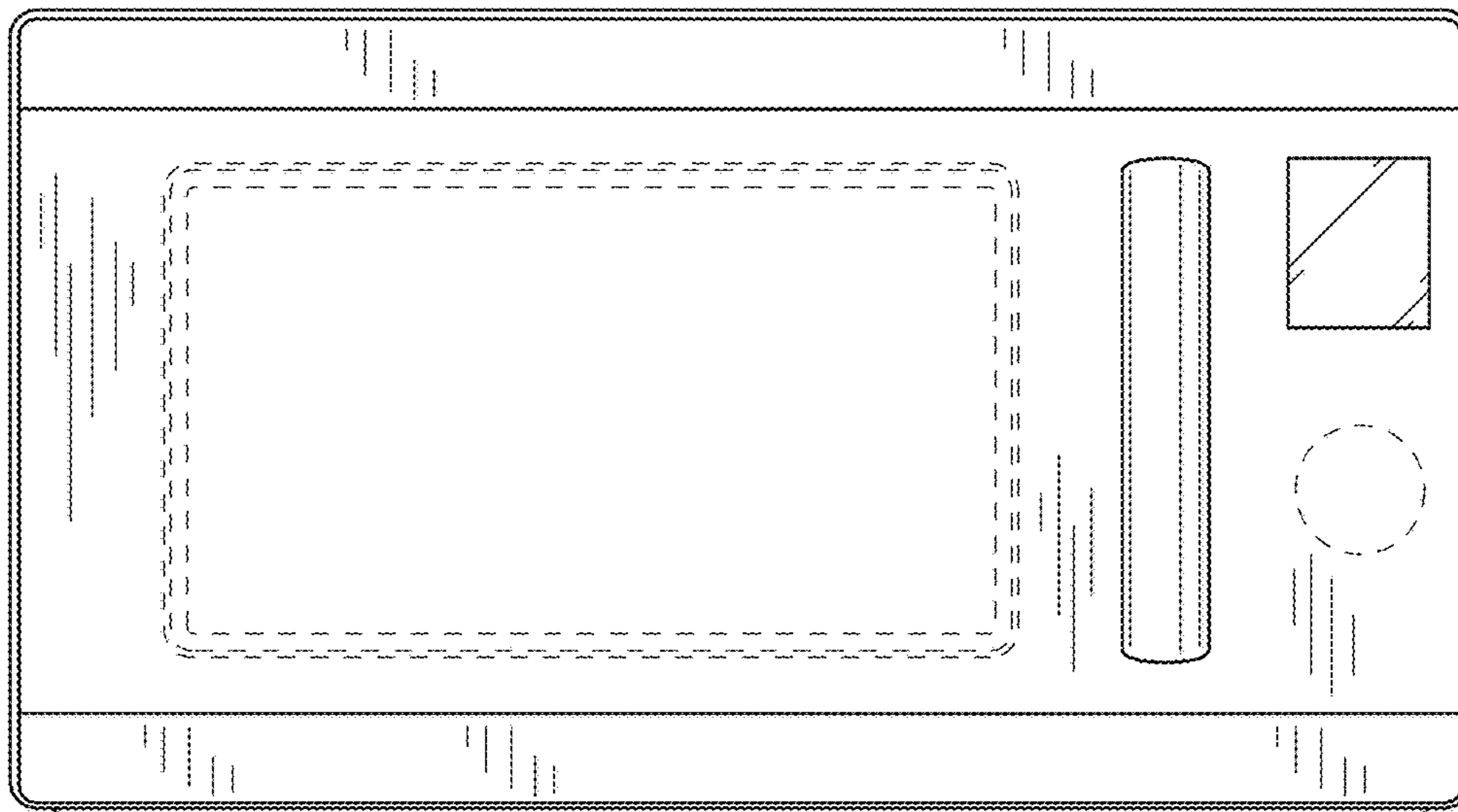

FIG.2

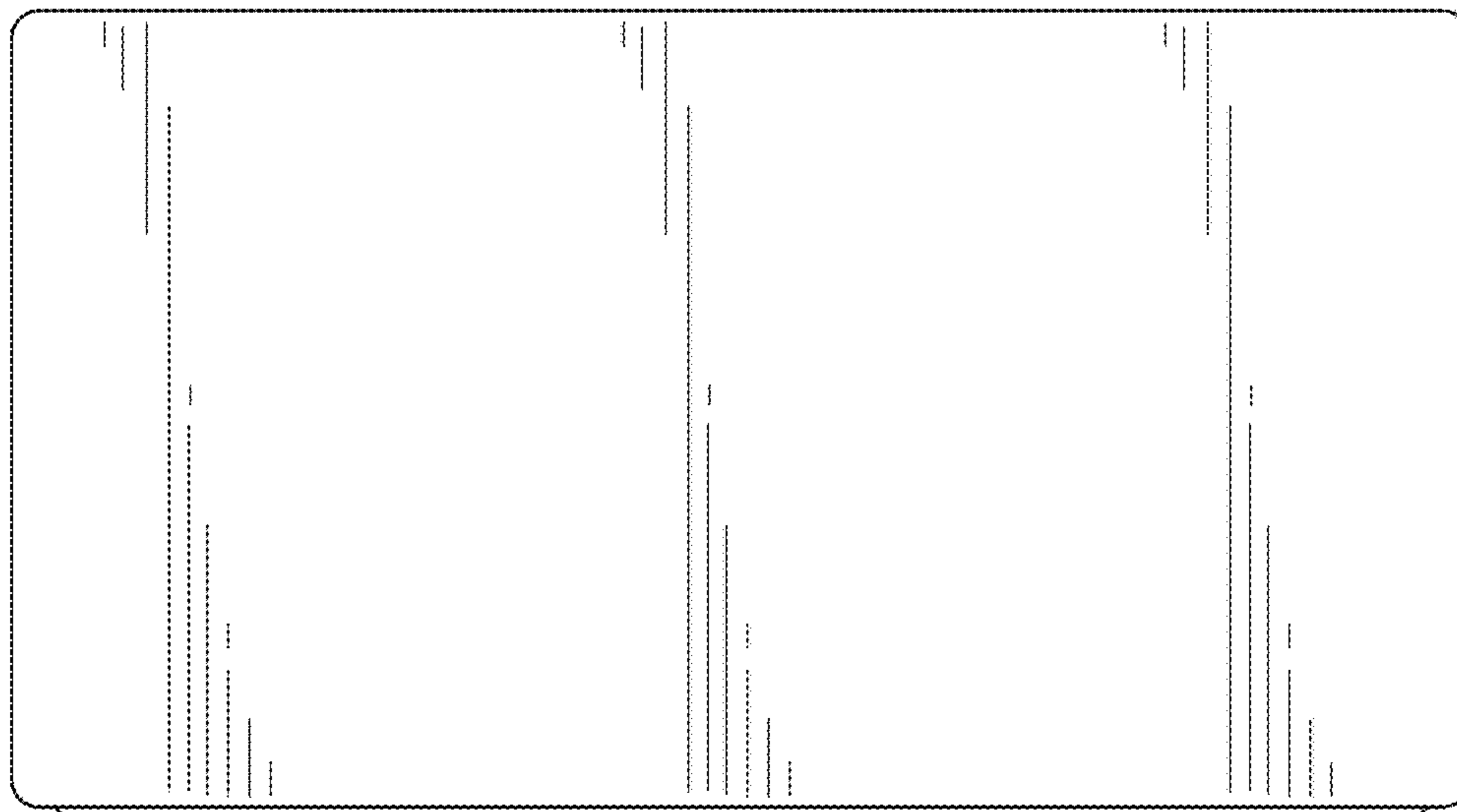

FIG.3

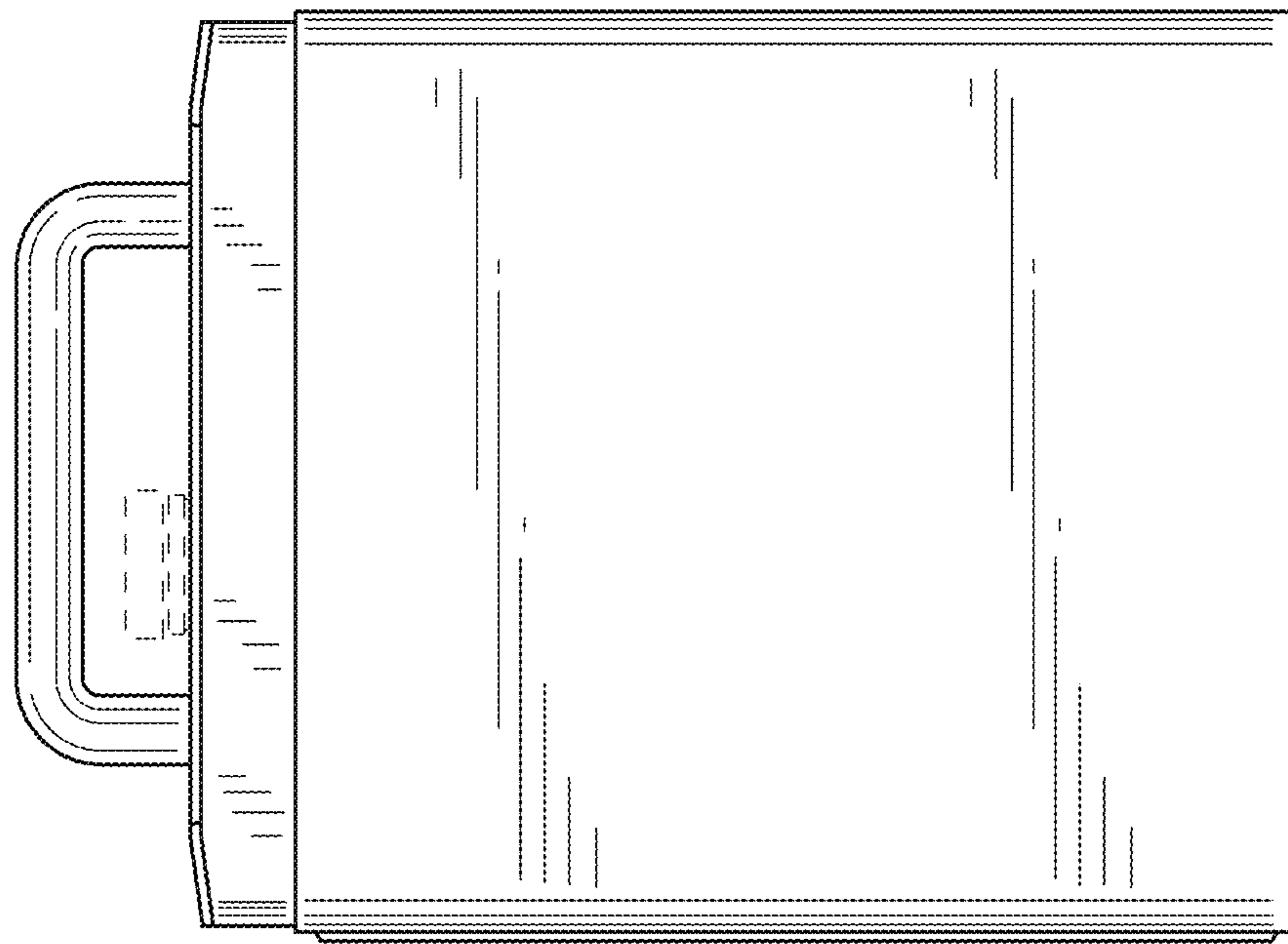

FIG. 4

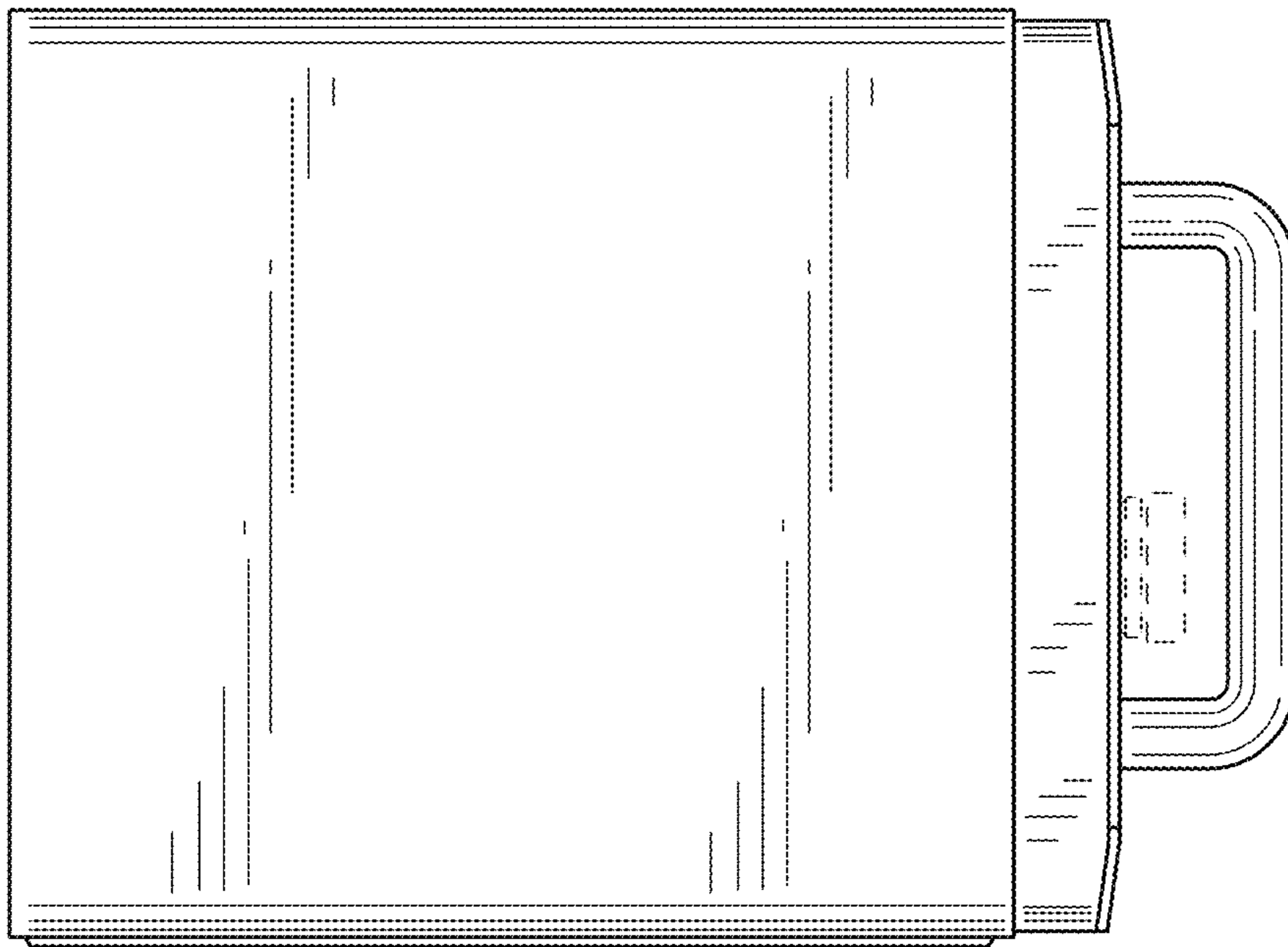

FIG. 5

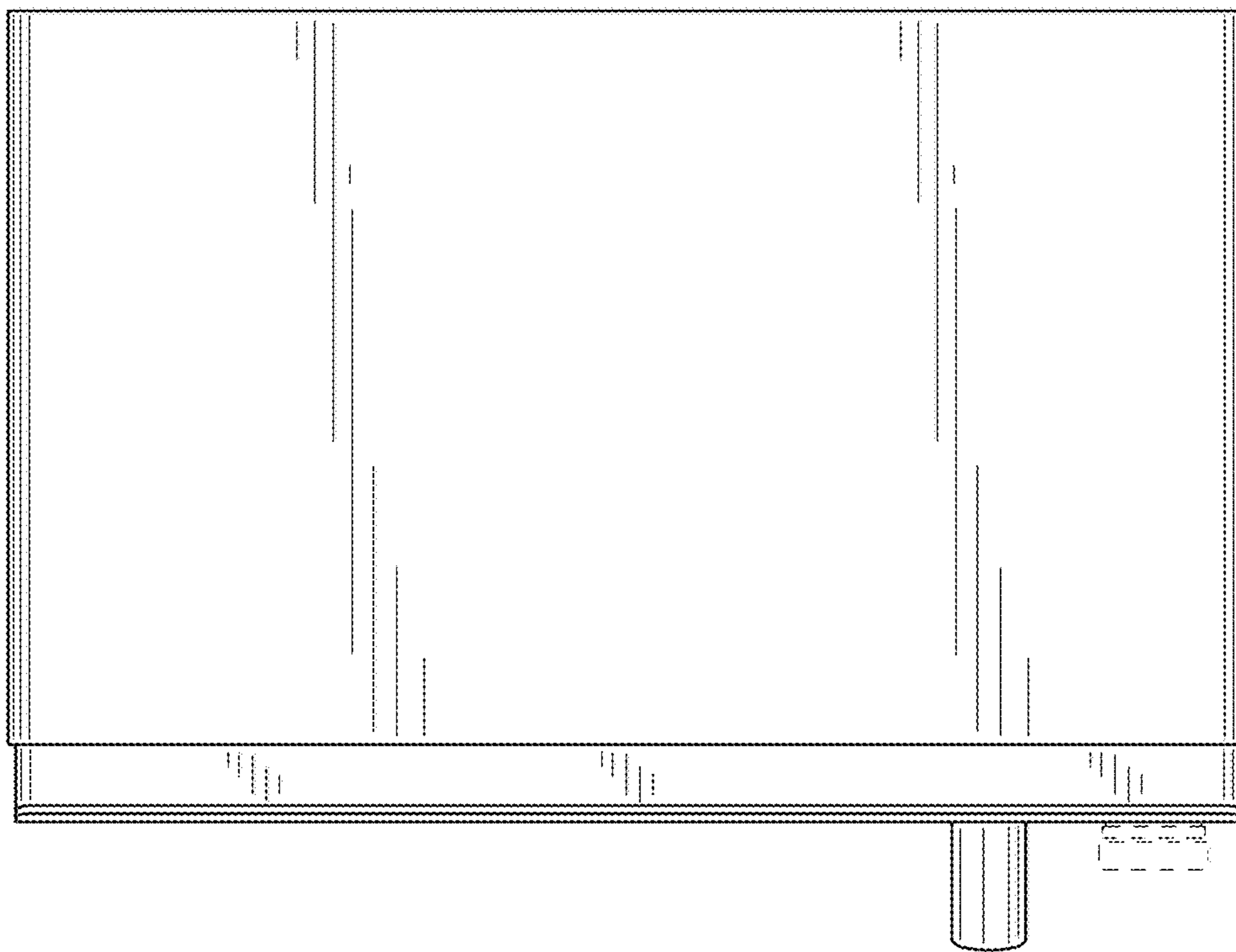

FIG.6

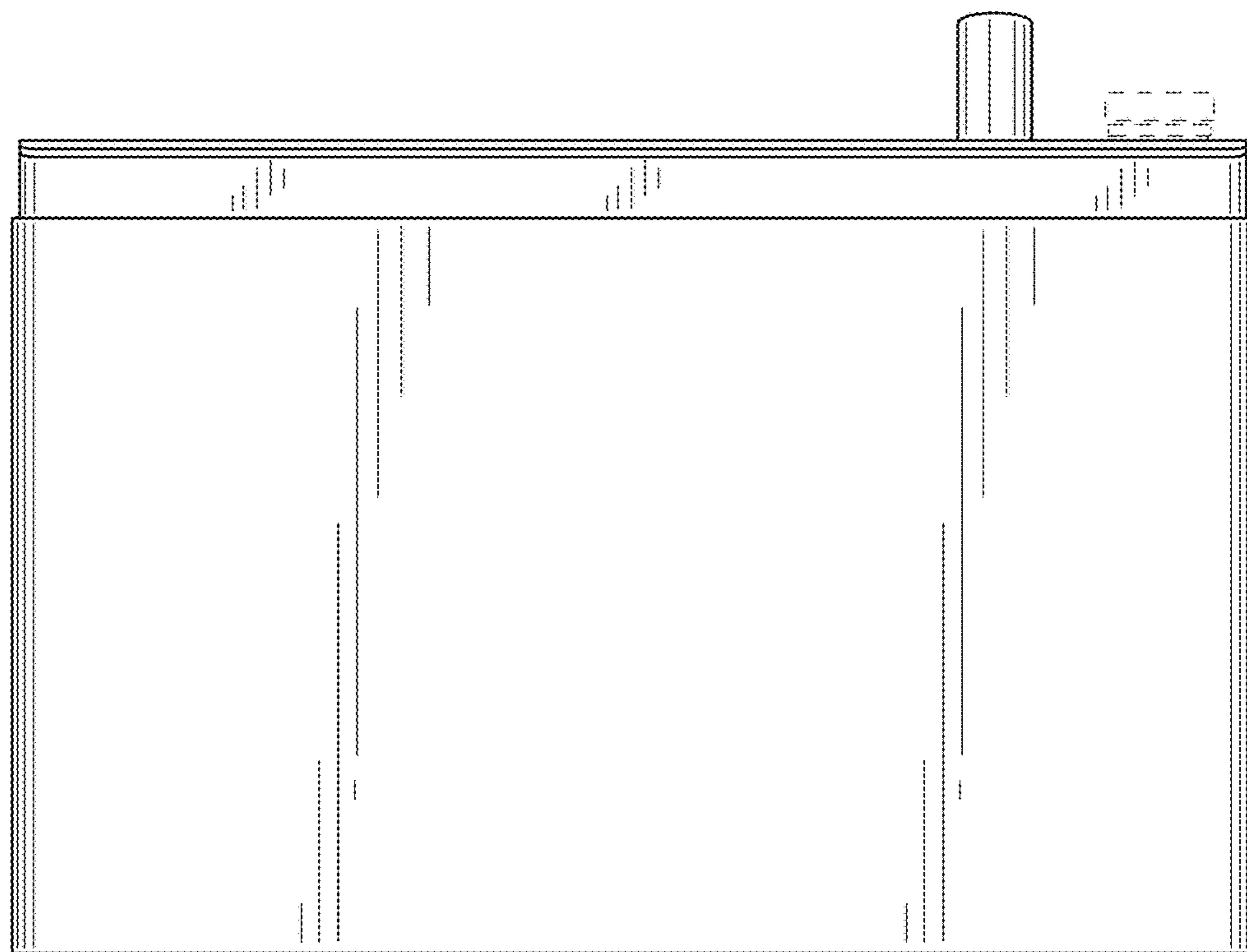

FIG.7