



US00D823025S

(12) **United States Design Patent** (10) **Patent No.:** **US D823,025 S**  
**Dennehy** (45) **Date of Patent:** **\*\* Jul. 17, 2018**

(54) **BOAT SEAT CUSHION**

FOREIGN PATENT DOCUMENTS

(71) Applicant: **Martin J. Dennehy**, Dedham, MA (US)

GB 2165623 A 9/1985  
GB 2502508 A 12/2013  
JP 2010221861 A 10/2010

(72) Inventor: **Martin J. Dennehy**, Dedham, MA (US)

OTHER PUBLICATIONS

(73) Assignee: **REGAL BOAT SEAT CUSHIONS INC.**, Wrentham, MA (US)

“Wise Deluxe Pontoon,” Restore Pontoon, restorepontoon.com, SKU: WD125-CO-xxxx, accessed: Jan. 15, 2016. <http://www.restorepontoon.com/pontoon/pc/viewPrd.asp?idproduct=3042>.

(Continued)

(\*\*) Term: **15 Years**

*Primary Examiner* — Michelle E Wilson

(21) Appl. No.: **29/563,731**

*Assistant Examiner* — Sanjeev Paul

(22) Filed: **May 6, 2016**

(74) *Attorney, Agent, or Firm* — Kriegsman & Kriegsman

(51) **LOC (11) Cl.** ..... **06-09**

(57) **CLAIM**

(52) **U.S. Cl.**

I claim the ornamental design for a boat seat cushion, as shown and described.

USPC ..... **D6/601**

(58) **Field of Classification Search**

**DESCRIPTION**

USPC ..... D6/333, 349, 355, 375, 388, 512, 563, D6/564, 595, 596, 601, 604, 611, 707, D6/715, 716, 716.1; D24/183–185, 234; D21/803, 804, 805, 809; 5/401, 420, 5/600, 630, 631, 632, 633, 635, 636, 638, 5/639, 646, 652, 652.1, 655, 703, 730; 297/1, 2, 4, 93, 180.11, 195.1, 195.11, 297/195.13, 393, 397, 452.12, 452.14, 297/452.15, 452.21, 452.24, 452.26, 297/452.48, 452.62, 482  
CPC .. A47G 9/1018; A47G 9/1009; A47G 9/1027; A47G 9/1045; A47G 9/1063; A47G 9/1072; A47G 9/1081  
See application file for complete search history.

FIG. 1 is a perspective view of a boat seat cushion, showing my new design;  
FIG. 2 is a top view thereof;  
FIG. 3 is a bottom view thereof;  
FIG. 4 is a right side view thereof;  
FIG. 5 is a left side view thereof;  
FIG. 6 is a front view thereof;  
FIG. 7 is a rear side view thereof; and,  
FIG. 8 is a right side view showing the boat seat cushion of FIG. 1 secured to a boat seat.

The broken lines shown in FIGS. 1-7 are directed to portions of the boat seat cushion that represent the bounds of the claimed design and are for illustrative purposes only. The broken lines shown in FIG. 8 are for illustrative purposes only and are directed to the environment in which the present invention is used or to portions of the boat seat cushion that represent the bounds of the claimed design. All broken lines in FIGS. 1-8 form no part of the design to be patented.

(56) **References Cited**

U.S. PATENT DOCUMENTS

2,782,840 A \* 2/1957 Ambrecht ..... A47C 1/10 297/228.11

3,369,262 A 2/1968 Judd

(Continued)

**1 Claim, 6 Drawing Sheets**

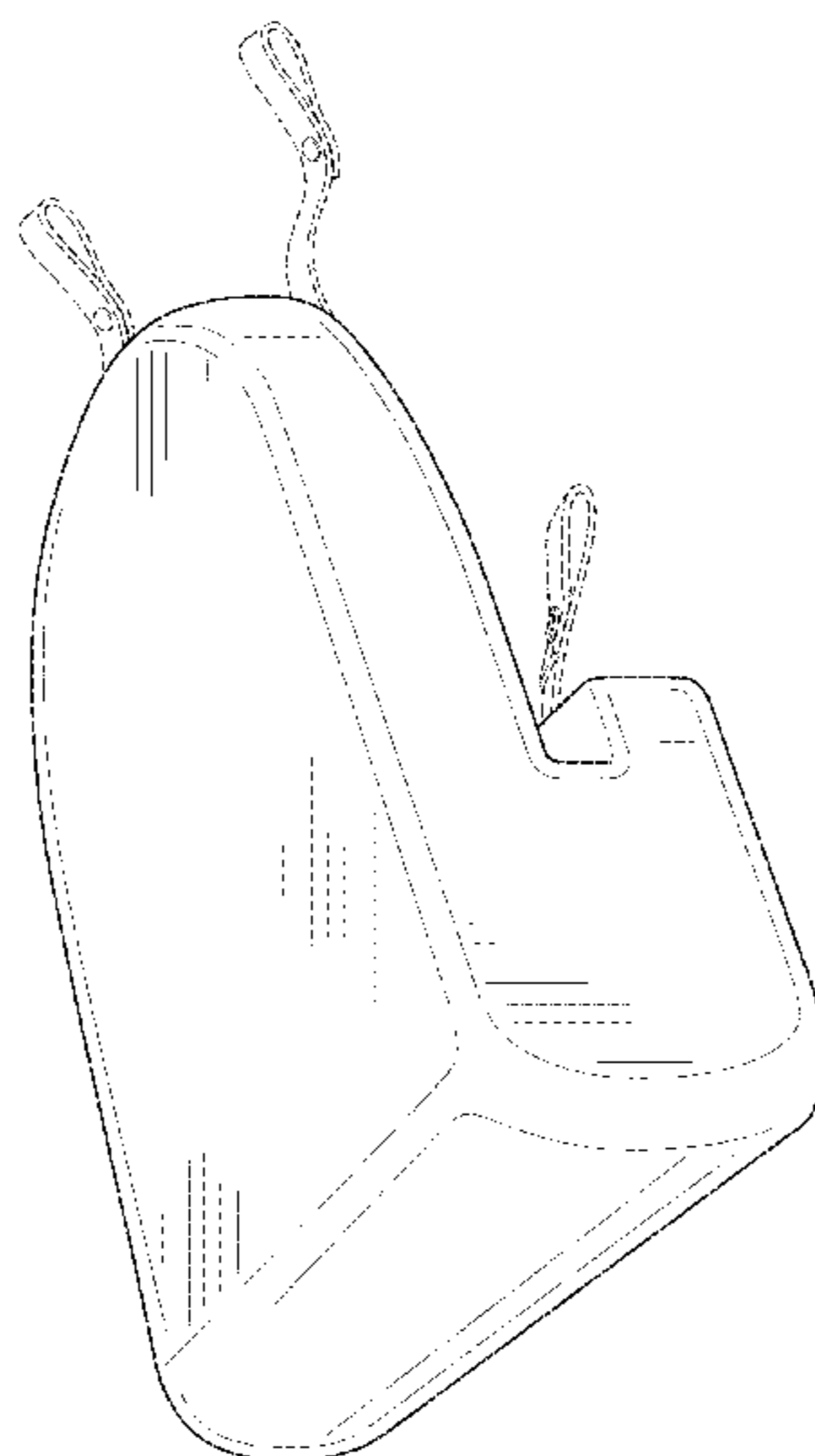

(56)

References Cited

U.S. PATENT DOCUMENTS

3,903,554 A 9/1975 Dodd  
 4,190,918 A 3/1980 Harvell  
 4,291,916 A 9/1981 Chardon  
 4,789,046 A 12/1988 McDowall  
 4,802,249 A 2/1989 Bills  
 4,926,783 A 5/1990 Lathers  
 D315,076 S 3/1991 Hanna  
 D315,993 S 4/1991 Wenderoth  
 5,029,928 A 7/1991 Huber  
 D324,769 S 3/1992 Hart  
 D324,970 S 3/1992 Kane  
 D328,001 S \* 7/1992 Kelly ..... D6/707  
 5,171,063 A 12/1992 Stidd  
 D336,791 S 6/1993 Stidd  
 D362,579 S 9/1995 Short  
 D366,383 S 1/1996 Briegleb  
 D366,800 S 2/1996 Moore, Jr.  
 5,491,851 A 2/1996 Alonso  
 D376,701 S 12/1996 Thompson  
 5,619,949 A 4/1997 Dick, Jr.  
 D379,047 S 5/1997 Richard  
 D381,855 S 8/1997 Galick  
 D382,756 S 8/1997 Ryan  
 5,857,423 A 1/1999 Imaeda et al.  
 5,950,263 A \* 9/1999 Hanson ..... A47C 1/023  
 297/452.21  
 6,042,093 A 3/2000 Garelick  
 6,325,456 B1 12/2001 Carnahan  
 D462,862 S \* 9/2002 Thayer, Jr. .... D6/601  
 D463,701 S \* 10/2002 Borcharding ..... D6/601  
 D474,934 S 5/2003 Ildstad et al.  
 D503,867 S 4/2005 Bennette et al.  
 D572,069 S 7/2008 McQueen  
 D575,536 S 8/2008 Bizzell et al.  
 7,523,988 B1 4/2009 Ratza et al.  
 D602,298 S 10/2009 Zwanzgleitner et al.  
 D634,951 S 3/2011 Dreiling  
 D635,265 S 3/2011 Coffey et al.  
 8,336,965 B2 12/2012 Kismarton et al.  
 D677,506 S 3/2013 Lai  
 D695,548 S 12/2013 Johnson  
 D696,532 S 12/2013 von Saher  
 D702,979 S \* 4/2014 Jannetides ..... D6/349  
 8,695,136 B2 4/2014 Pozzi  
 8,702,120 B2 4/2014 Kalisz et al.  
 8,782,835 B2 7/2014 Pozzi  
 D713,664 S \* 9/2014 Vetter ..... D6/716  
 8,910,330 B1 12/2014 Malik  
 D725,923 S \* 4/2015 Kaye ..... D6/349  
 D725,924 S \* 4/2015 Kaye ..... D6/349  
 D725,925 S 4/2015 Kaye  
 9,045,197 B2 6/2015 Chen  
 D737,073 S 8/2015 Hawkins  
 D740,043 S 10/2015 Lee

D747,117 S 1/2016 Lau  
 D749,873 S 2/2016 Latrofa  
 D769,028 S 10/2016 Little  
 D775,484 S \* 1/2017 Moore ..... D6/601  
 D790,235 S 6/2017 Chuah  
 2005/0138733 A1 6/2005 Riesberg et al.  
 2005/0177944 A1 8/2005 Kang et al.  
 2007/0001503 A1 \* 1/2007 Brady ..... A47C 16/02  
 297/423.4  
 2008/0315644 A1 12/2008 Briscoe  
 2010/0037814 A1 2/2010 Sahr et al.  
 2012/0256466 A1 10/2012 Lievestro et al.  
 2013/0263377 A1 10/2013 Wootten, Jr.  
 2015/0359353 A1 12/2015 Vainberg et al.  
 2016/0192794 A1 7/2016 Boyd  
 2016/0296031 A1 10/2016 Sramek  
 2016/0338514 A1 11/2016 Chan  
 2017/0320551 A1 11/2017 Dennehy

OTHER PUBLICATIONS

“Ladder Back Pilot Chair 1095 with Cushions, 15” Fixed Pedestal and Seat Slide—Wise Boat Seats,” *iboats™*, *iboats.com*, Part # WD1095-710, Jan. 15, 2016. [http://www.iboats.com/Ladder-Back-Pilot-Chair-1095-with-Cushions-15-Fixed-Pedestal-and-Seat-Slide-Wise-Boat-Seats/dm/cart\\_id.464238942--session\\_id.419910167--view\\_id.375626](http://www.iboats.com/Ladder-Back-Pilot-Chair-1095-with-Cushions-15-Fixed-Pedestal-and-Seat-Slide-Wise-Boat-Seats/dm/cart_id.464238942--session_id.419910167--view_id.375626).  
 “Deluxe Off White/Charcoal Vinyl Boat Bolster/Bucket/Drivers Seating Seat Chairs (Pair),” *Great Lakes Skipper™*, *greatlakesskipper.com*, GLS Stock #: 1045989, Part #: M2540BB00307, Jan. 15, 2016 <http://greatlakesskipper.com/deluxe-off-white-charcoal-vinyl-boat-bolster-bucket-drivers-seating-seat-chairs-pair>.  
 Jim Buoy Flotation Cushion, available at least on Aug. 27, 2013, [online], [site visited Aug. 2, 2017]. Available from Internet, <URL:<http://www.defender.com/category.jsp?path=-1%7C135%7C2290066&id=2290114>>.  
 U.S. Appl. No. 29/563,721, inventor Martin J. Dennehy, filed May 6, 2016.  
 U.S. Appl. No. 29/630,607, inventor Martin J. Dennehy, filed Dec. 21, 2017.  
 Millennium ComfortMax SW-200 Saltwater Casting Boat Seat, accessed Oct. 2, 2017, <http://www.basspro.com/shop/en/millennium-comfortmax-sw-200-saltwater-casting-boat-seat>.  
 Millennium ComfortMax SW-200 Saltwater Casting Boat Seat, accessed Dec. 22, 2017, <http://www.millenniummarine.com/sw-series/sw-200/sw-200-white/>.  
 Tempress Guide Series Casting Seat, accessed Oct. 2, 2017, <http://www.basspro.com/shop/en/tempress-guide-series-casting-seat>.  
 Tempress Guide Series Casting Seat, accessed Dec. 22, 2017, <https://tempress.com/storeTEMPRESS-Guide-Series-Casting-Seat-Blue-Gray-p36736269>.  
 U.S. Appl. No. 29/627,572, inventor Martin J. Dennehy, filed Nov. 28, 2017.

\* cited by examiner

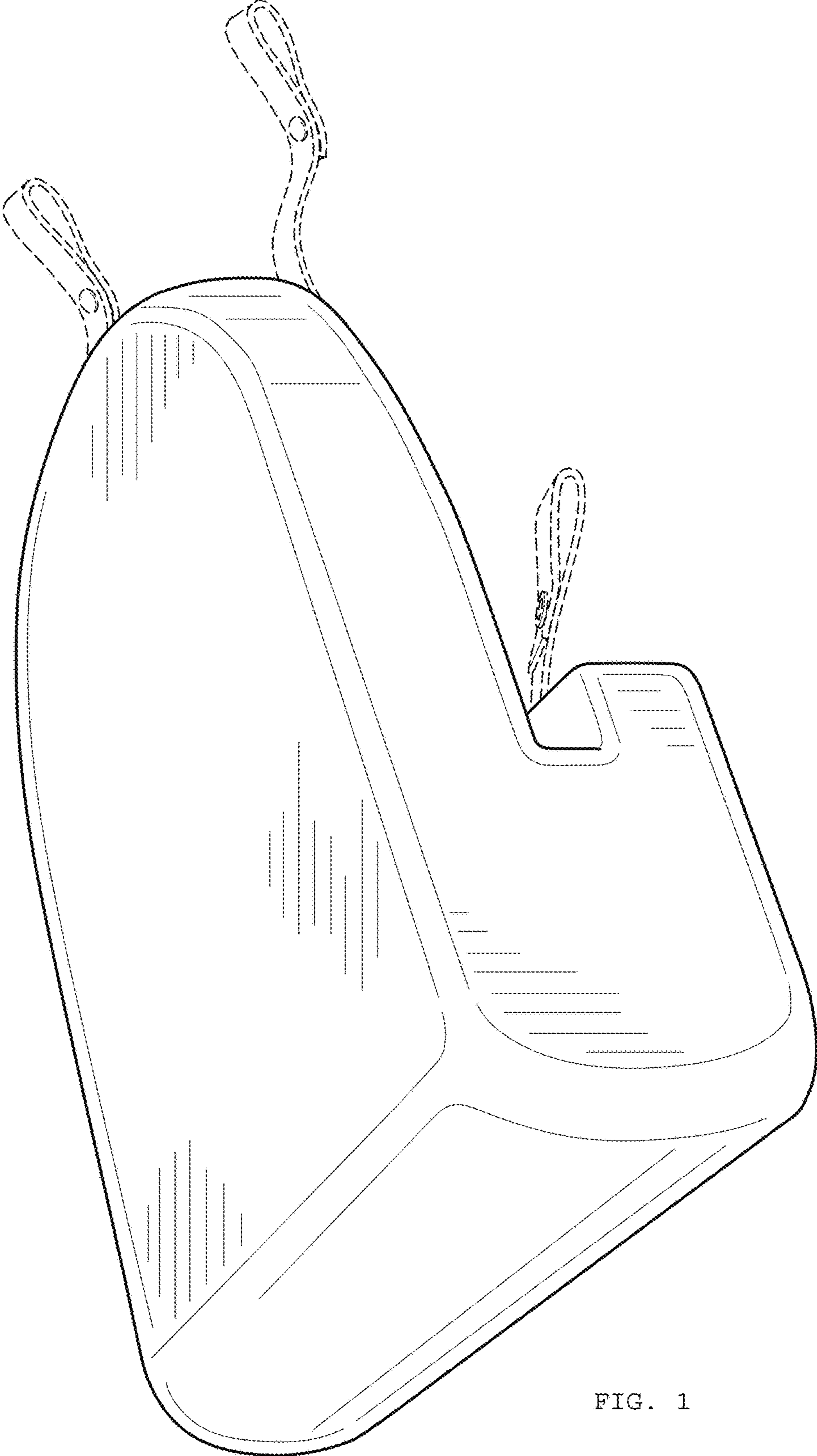

FIG. 1



FIG. 2

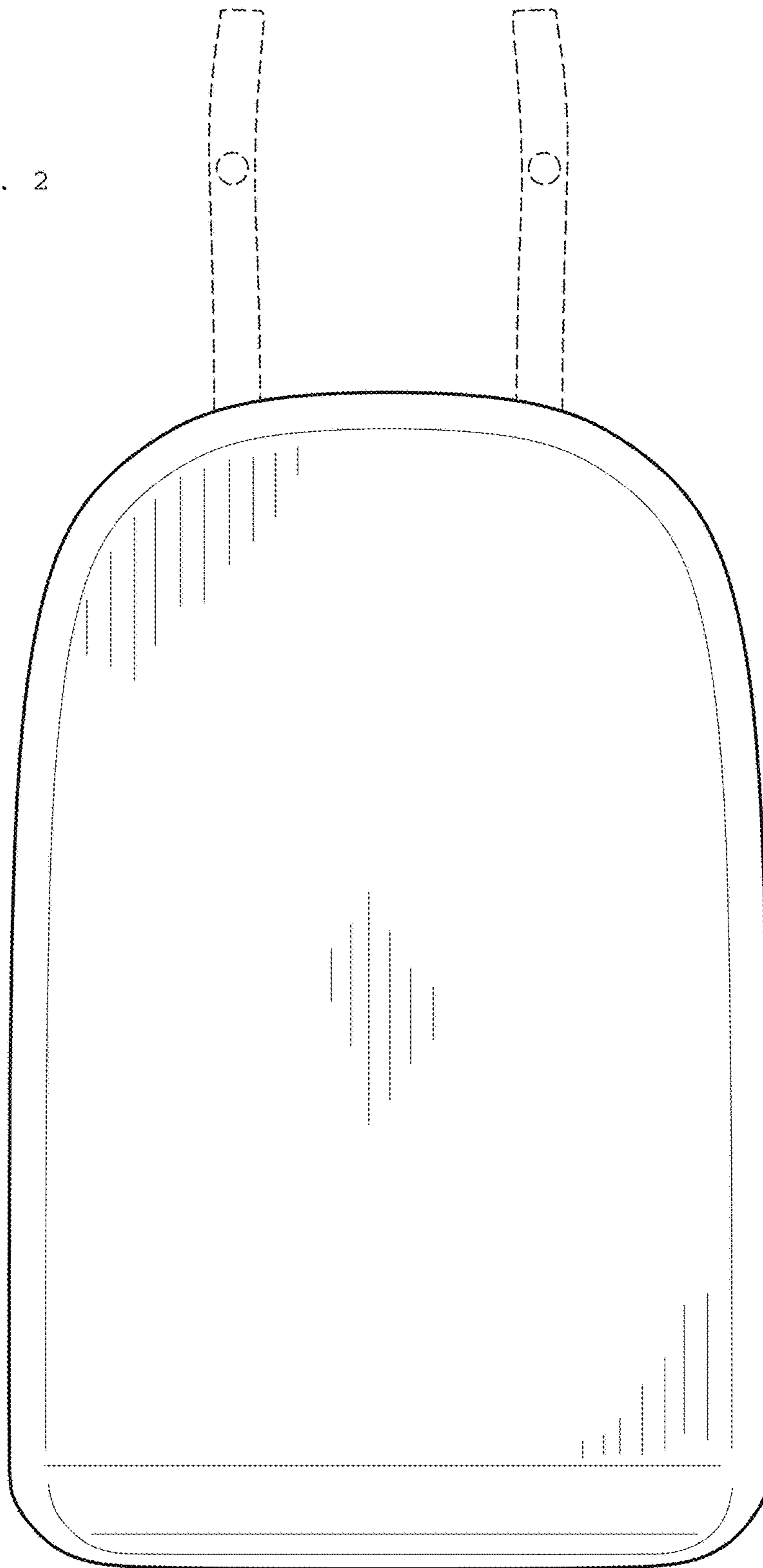

FIG. 3

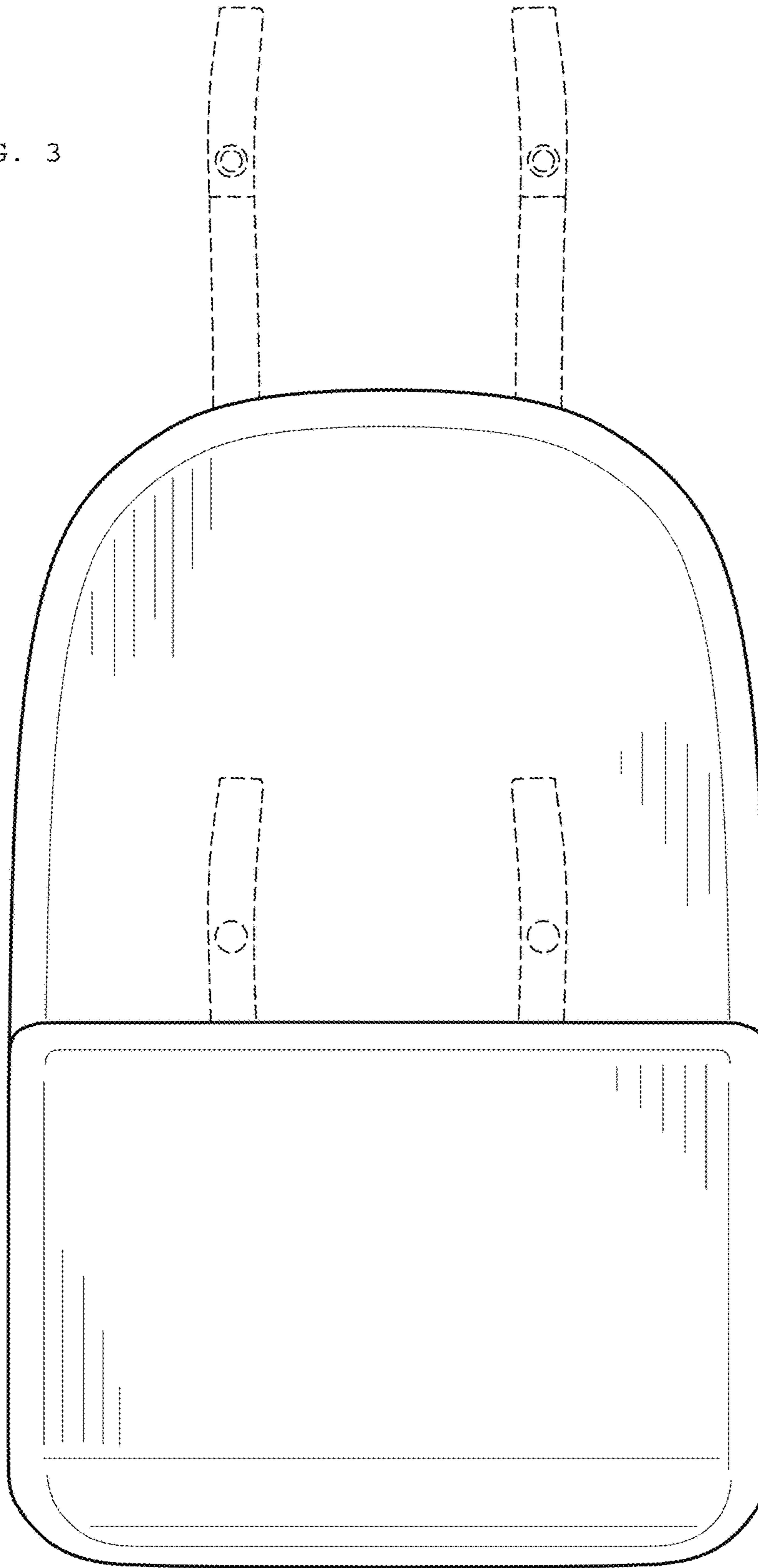

FIG. 4

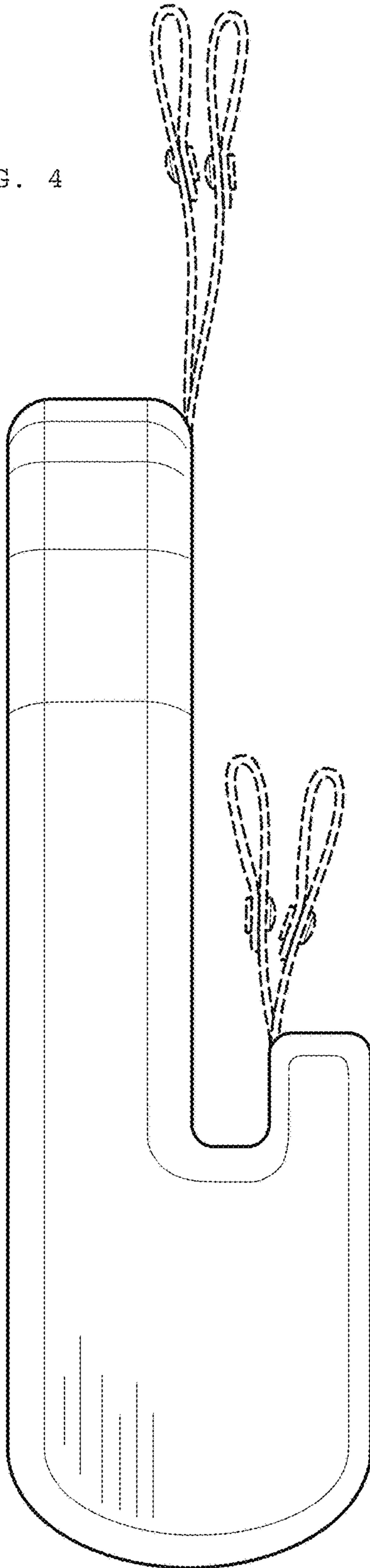
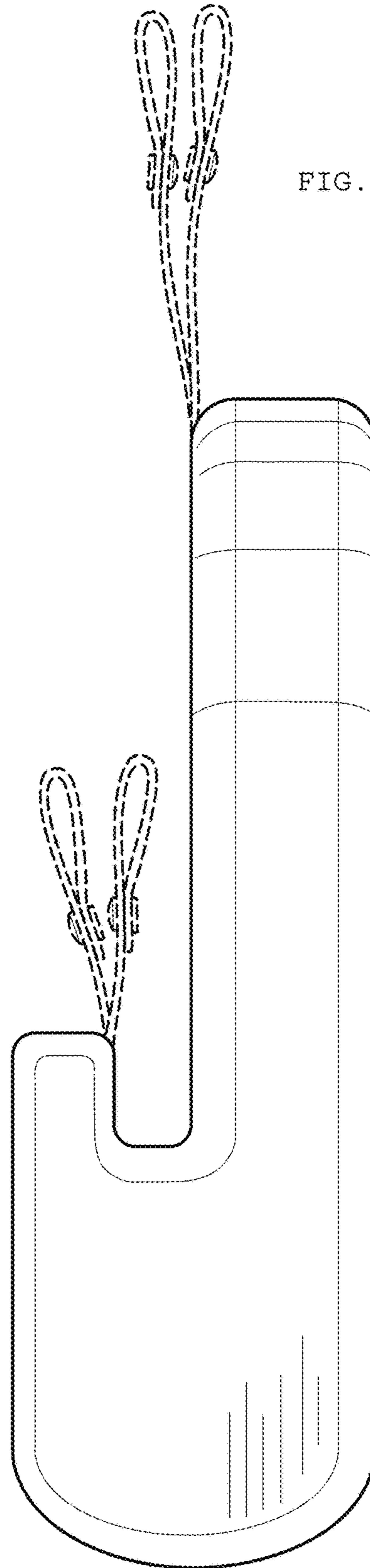

FIG. 5



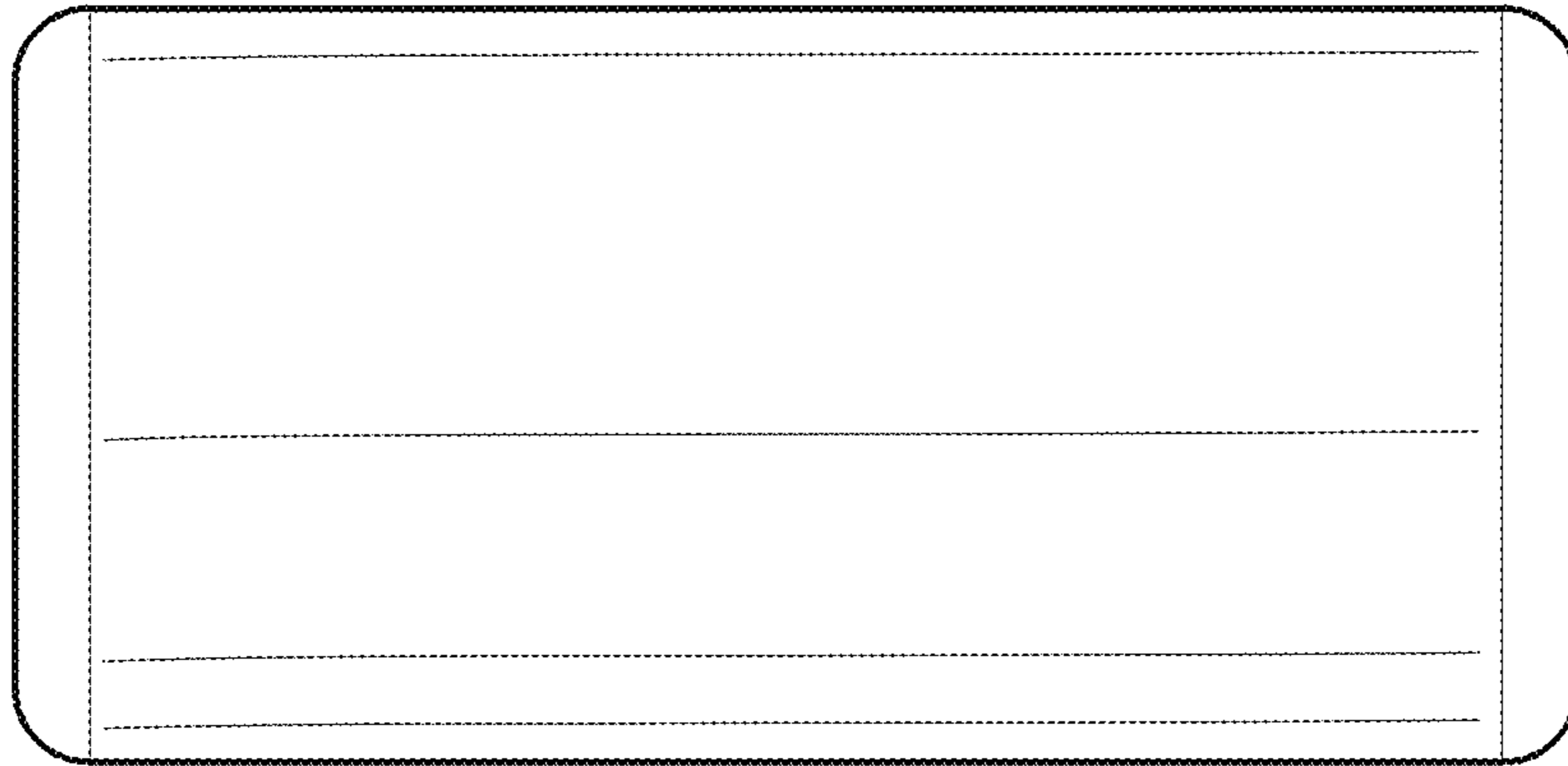

FIG. 6

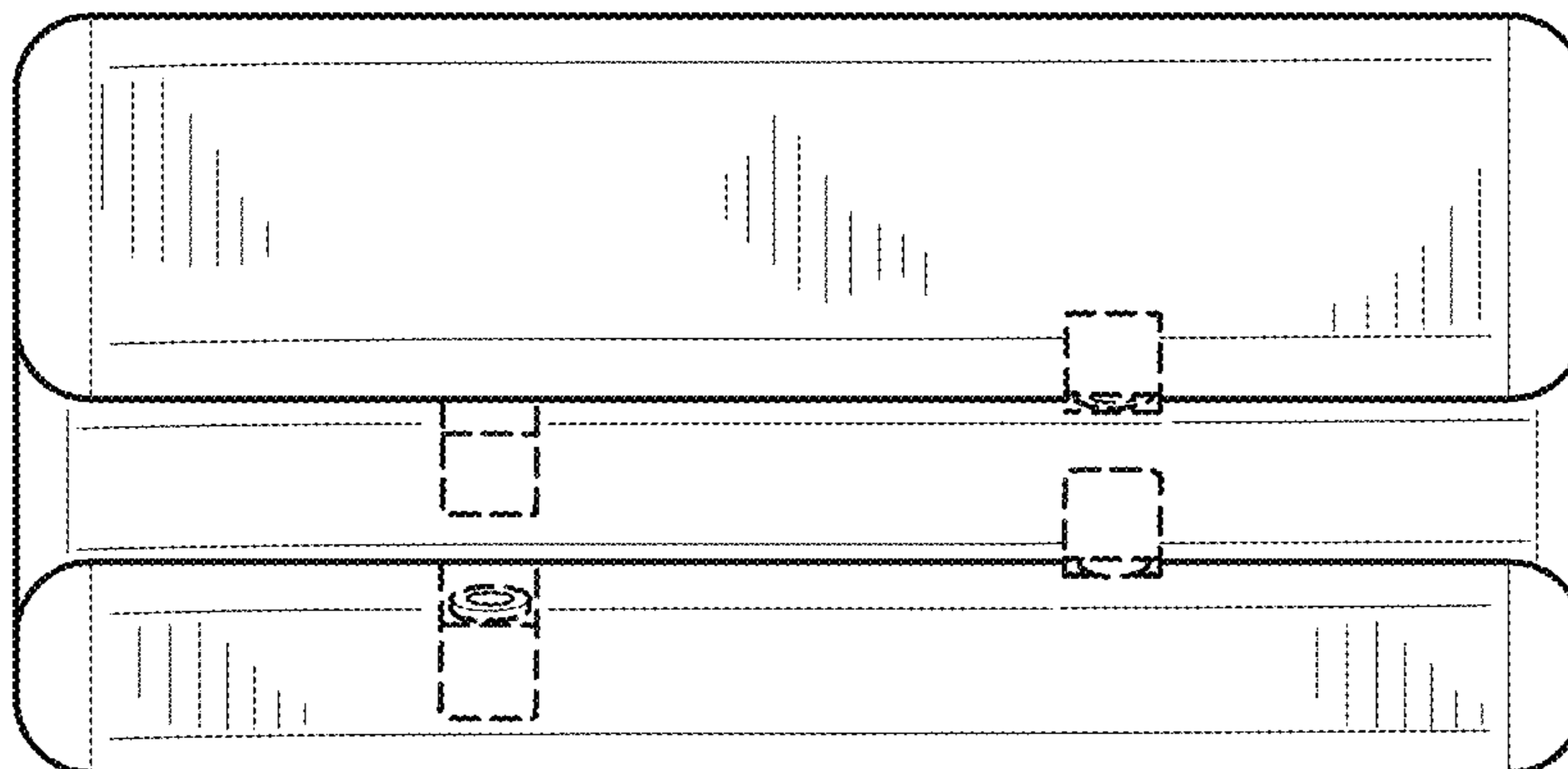

FIG. 7

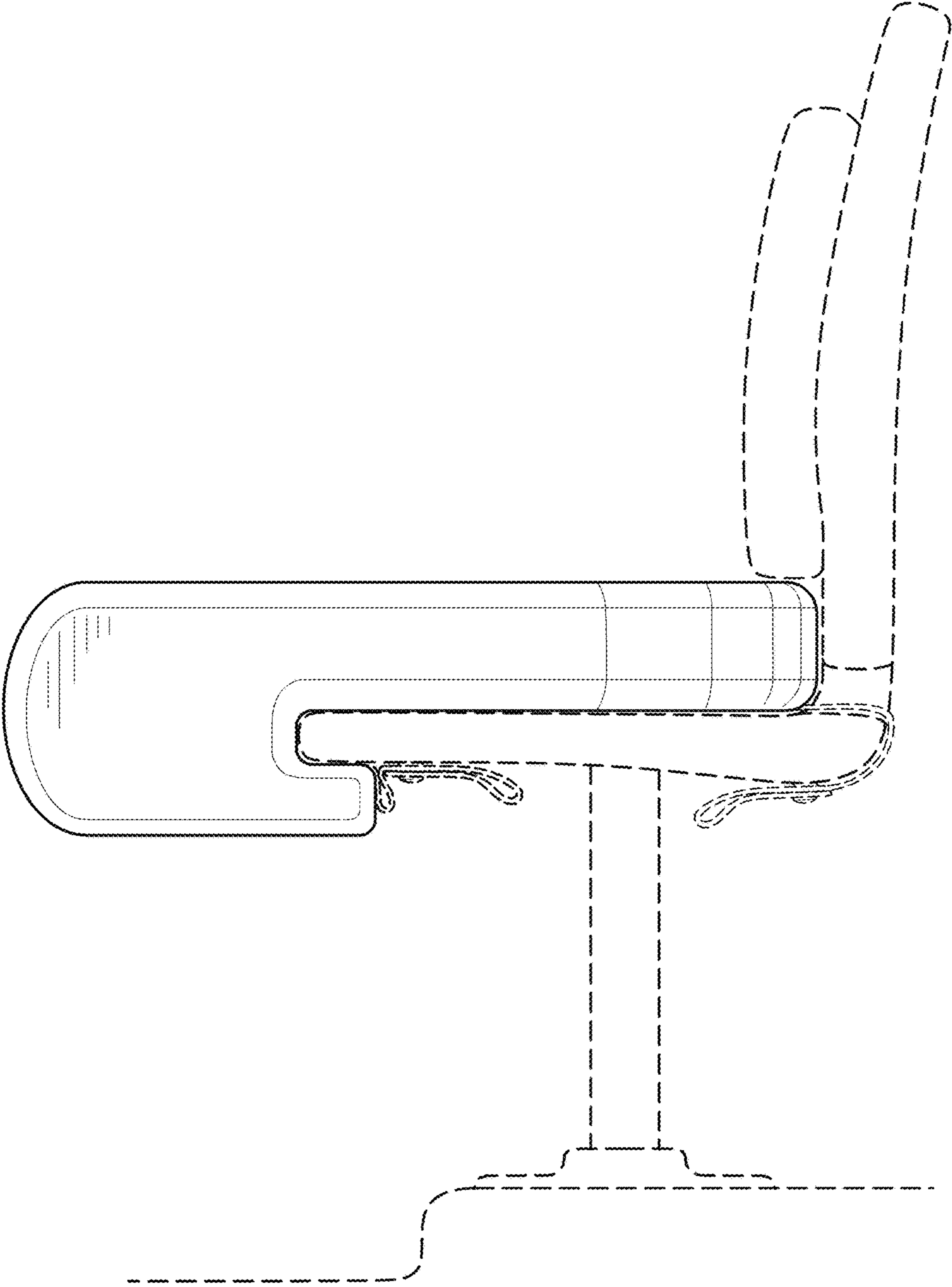

FIG. 8