



US00D822988S

(12) **United States Design Patent**
Taylor

(10) **Patent No.:** **US D822,988 S**

(45) **Date of Patent:** **** *Jul. 17, 2018**

(54) **WALLET**

(71) Applicant: **SlideBelts Inc.**, El Dorado Hills, CA (US)

(72) Inventor: **Brigham Thomas Taylor**, El Dorado Hills, CA (US)

(73) Assignee: **SLIDEBELTS INC.**, El Dorado Hills, CA (US)

(*) Notice: This patent is subject to a terminal disclaimer.

(**) Term: **15 Years**

(21) Appl. No.: **29/564,423**

(22) Filed: **May 12, 2016**

(51) **LOC (11) Cl.** **03-01**

(52) **U.S. Cl.**
USPC **D3/247**

(58) **Field of Classification Search**
USPC D3/247, 249-253
CPC A45C 1/06; A45C 3/08
See application file for complete search history.

(56) **References Cited**

U.S. PATENT DOCUMENTS

D720,530 S *	1/2015	Abramson	D3/247
D727,619 S *	4/2015	DeChant	D3/247
D730,646 S *	6/2015	DeChant	D3/247
D755,513 S *	5/2016	DeChant	D3/247
D756,643 S *	5/2016	DeChant	D3/247

OTHER PUBLICATIONS

webpage: triHOLD: The No-Compromise Compact Front Wallet by triHOLD Inc., retrieved from <https://web.archive.org/web/20130728183201/http://www.kickstarter.com/projects/weisberg/>

trihold-the-no-compromise-compact-front-pocket-wal?ref=live, archived on Jul. 28, 2013, accessed on Aug. 22, 2017, including with 4 screenshots from embedded videos, 10 pages.

* cited by examiner

Primary Examiner — Holly H Baynham

(74) *Attorney, Agent, or Firm* — Knobbe, Martens, Olson & Bear, LLP

(57) **CLAIM**

The ornamental design for a wallet, as shown and described.

DESCRIPTION

FIG. 1 is a front, top, and side perspective view of an embodiment of a wallet in a first open position;
 FIG. 2 is a rear view thereof;
 FIG. 3 is a front view thereof;
 FIG. 4 is a first side view thereof;
 FIG. 5 is a second side view thereof;
 FIG. 6 is a top view thereof;
 FIG. 7 is a bottom view thereof;
 FIG. 8 is a front, top, and side perspective view of an embodiment of a wallet in a second open position;
 FIG. 9 is a front, top, and side perspective view of an embodiment of a wallet in a closed position;
 FIG. 10 is a front, top and side perspective view of a second embodiment of a wallet in an opened position.
 FIG. 11 is a rear view thereof;
 FIG. 12 is a front view thereof;
 FIG. 13 is a first side view thereof;
 FIG. 14 is a second side view thereof;
 FIG. 15 is a top view thereof;
 FIG. 16 is a bottom view thereof;
 FIG. 17 is a front, top and side perspective in a second opened position; and,
 FIG. 18 is a front, top and side perspective view in a closed position.

Broken lines are used to illustrate features of the wallet that are disclaimed and form no part of the claimed design.

1 Claim, 16 Drawing Sheets

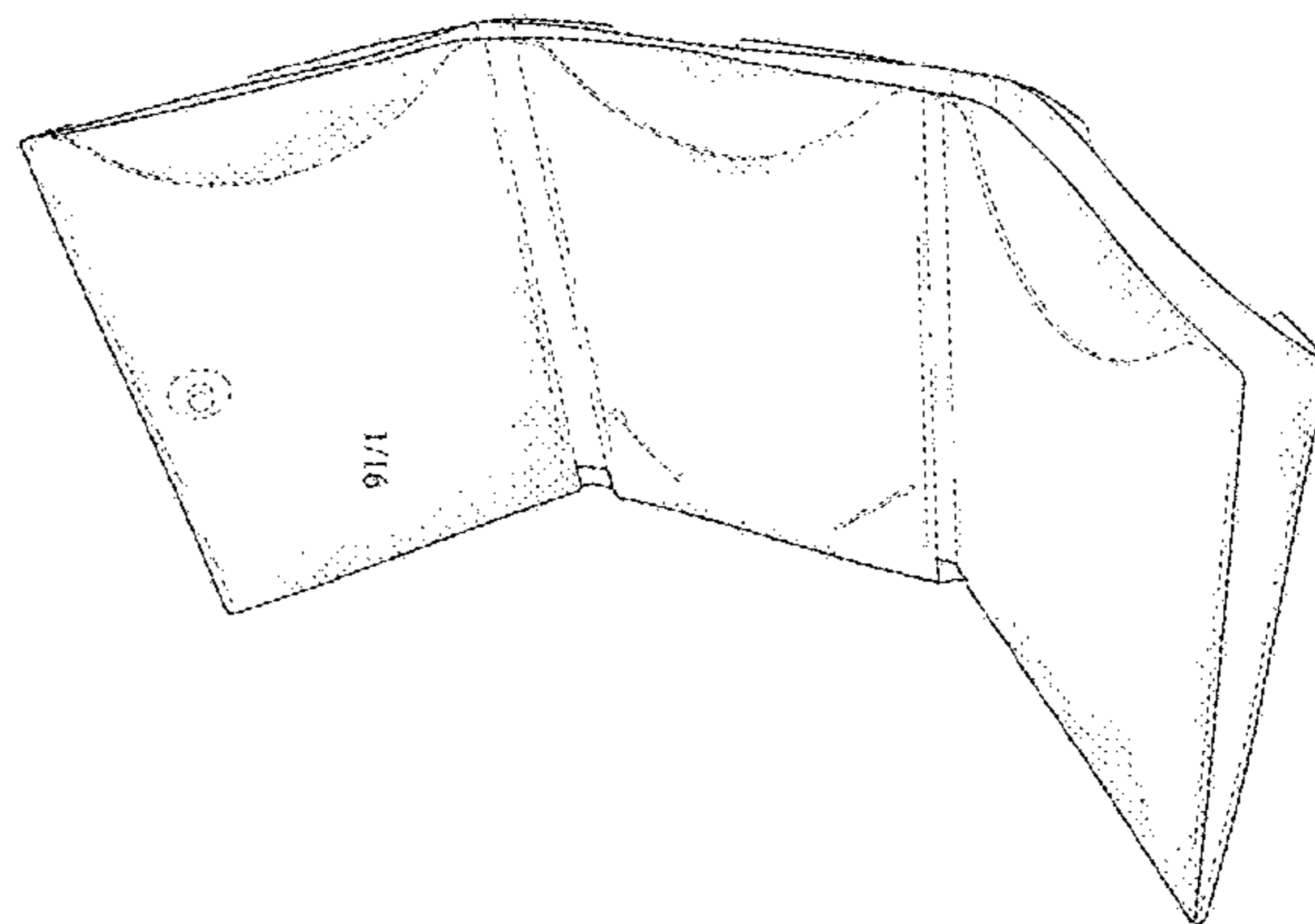
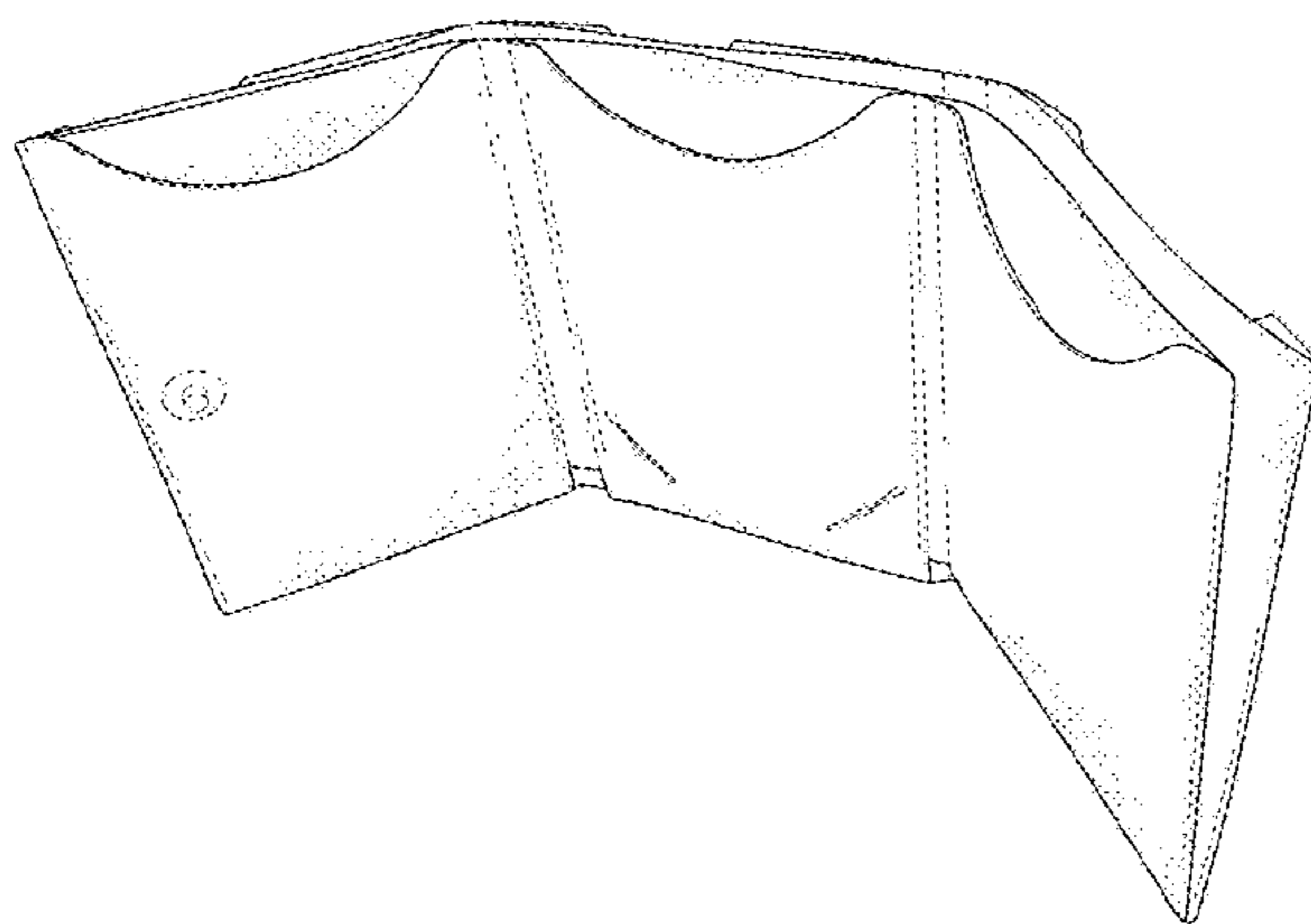

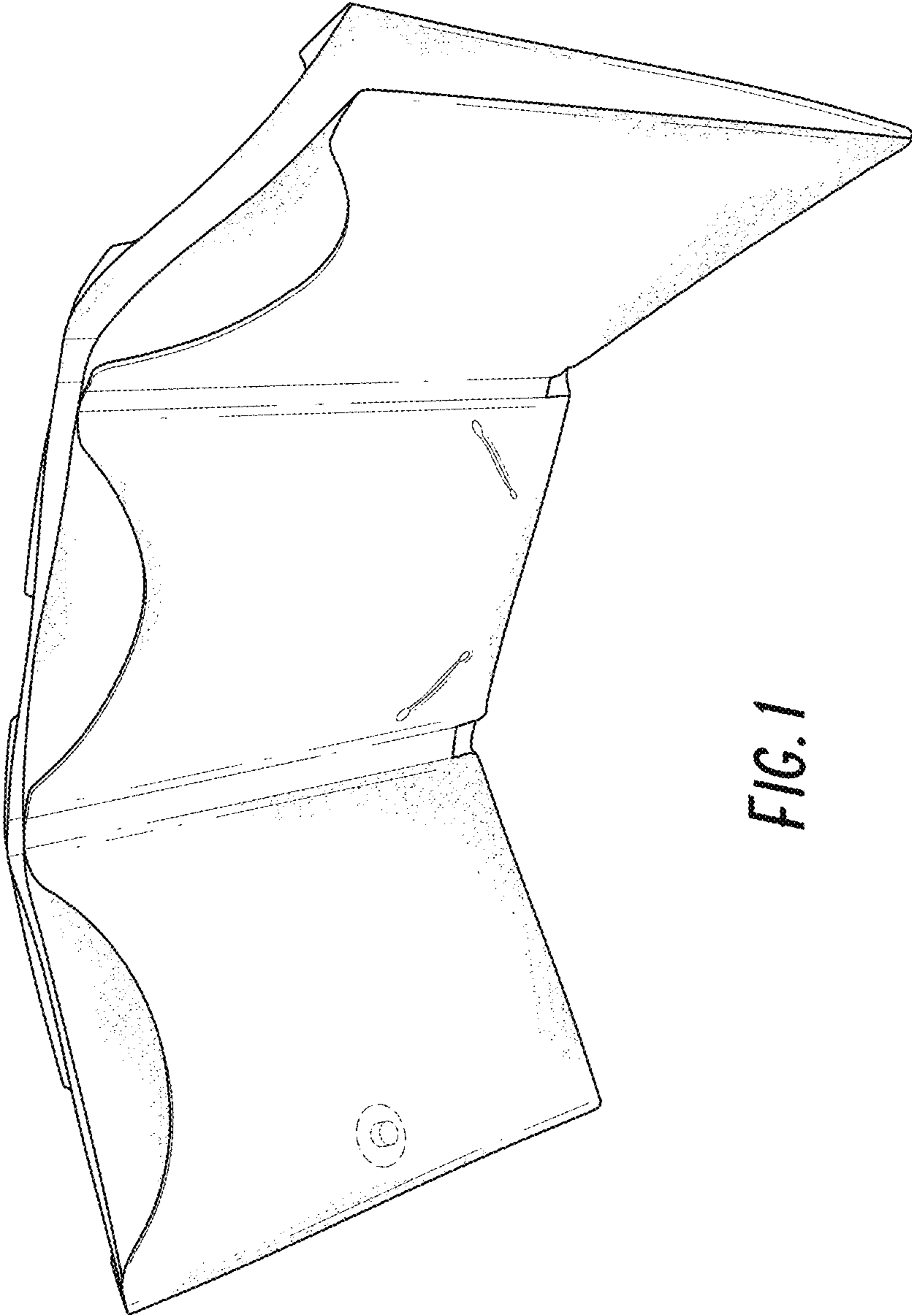

FIG. 1

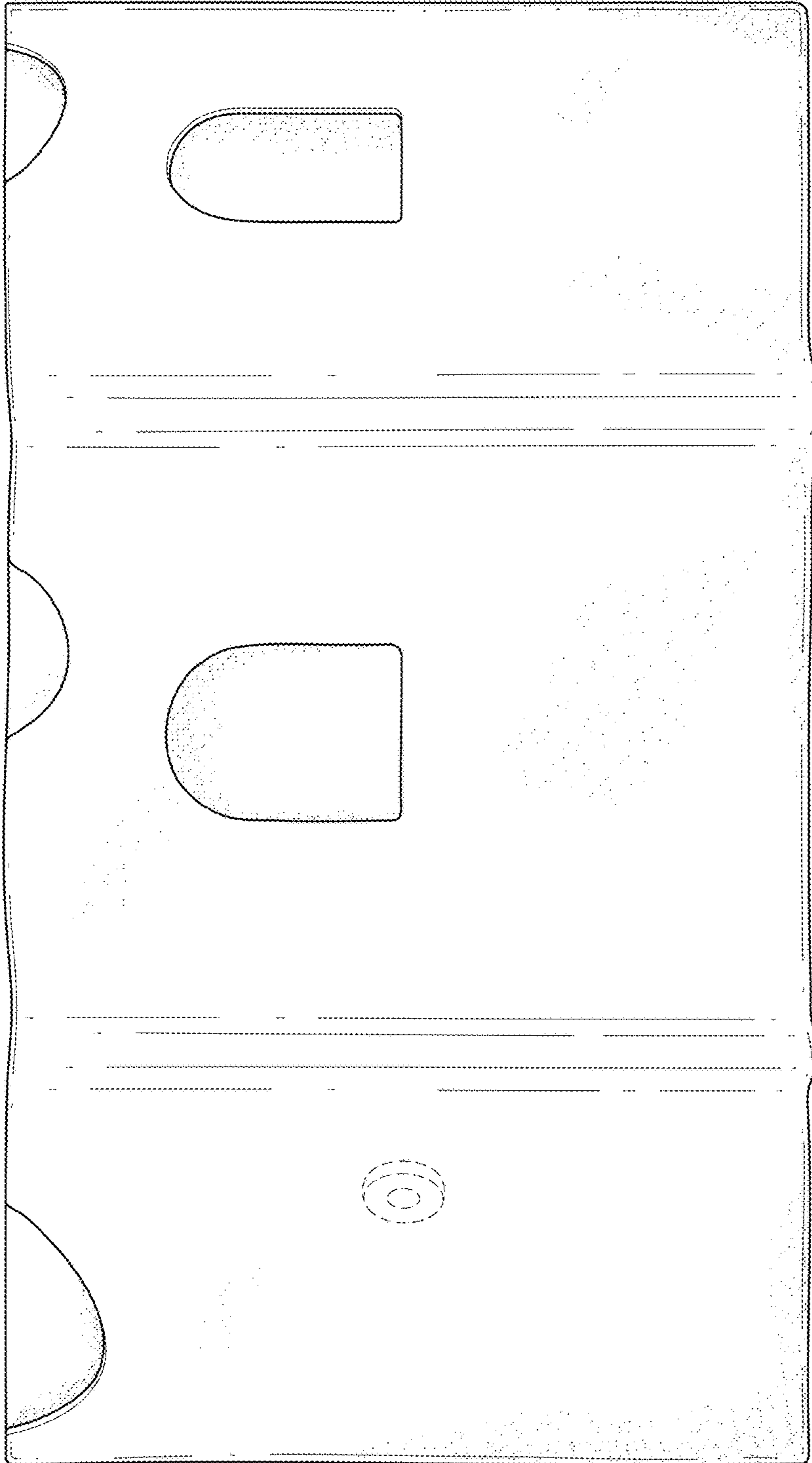

FIG. 2

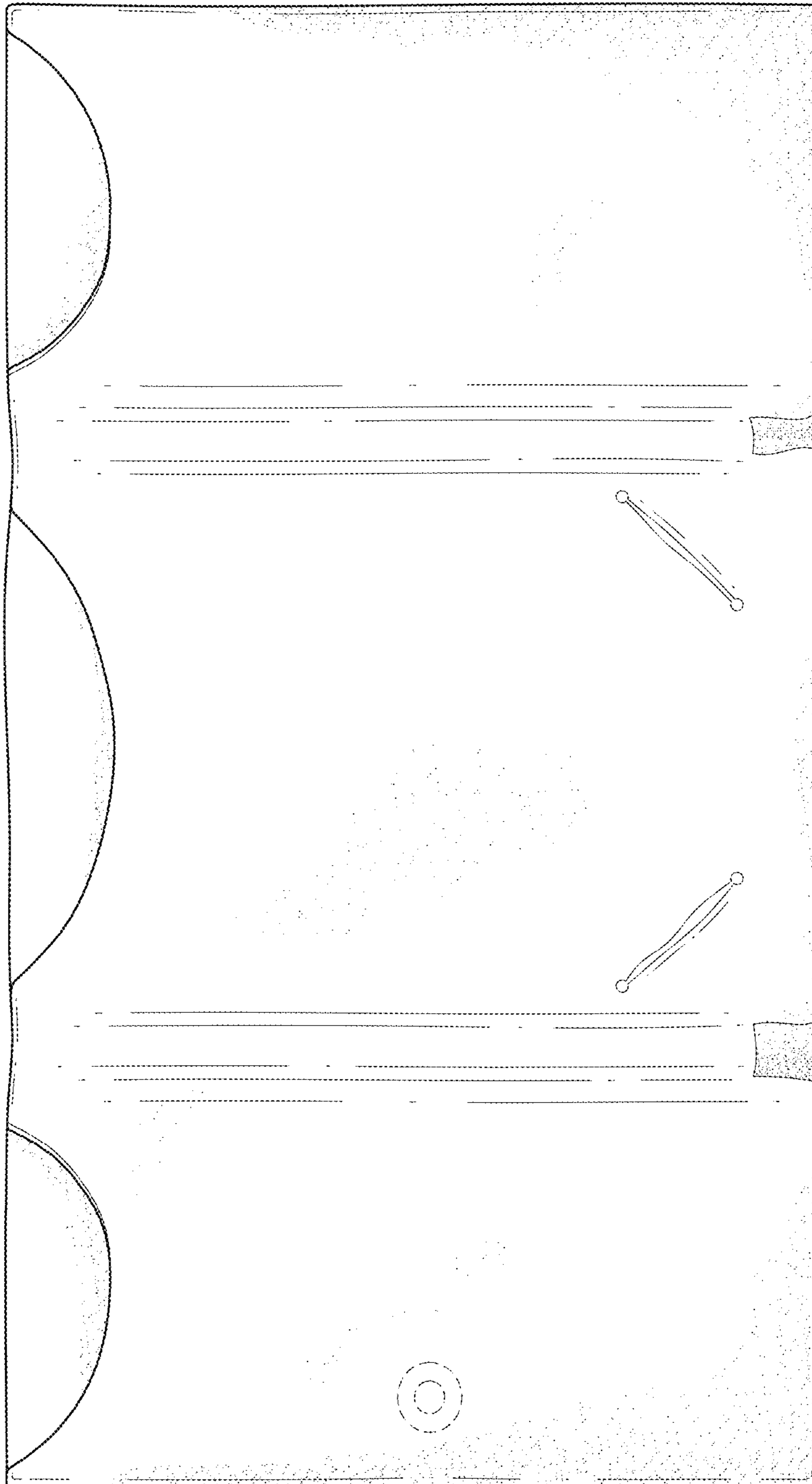

FIG. 3

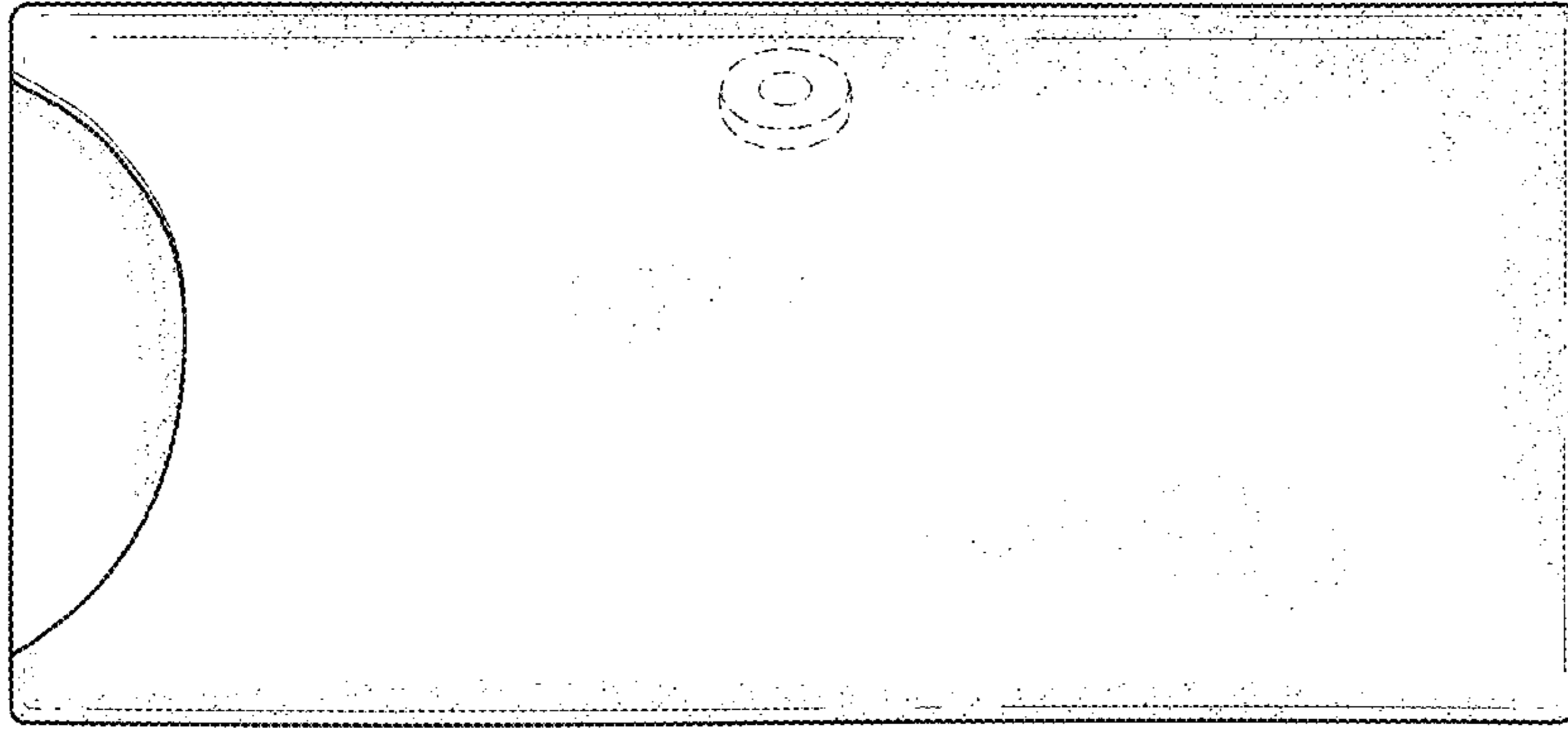

FIG. 5

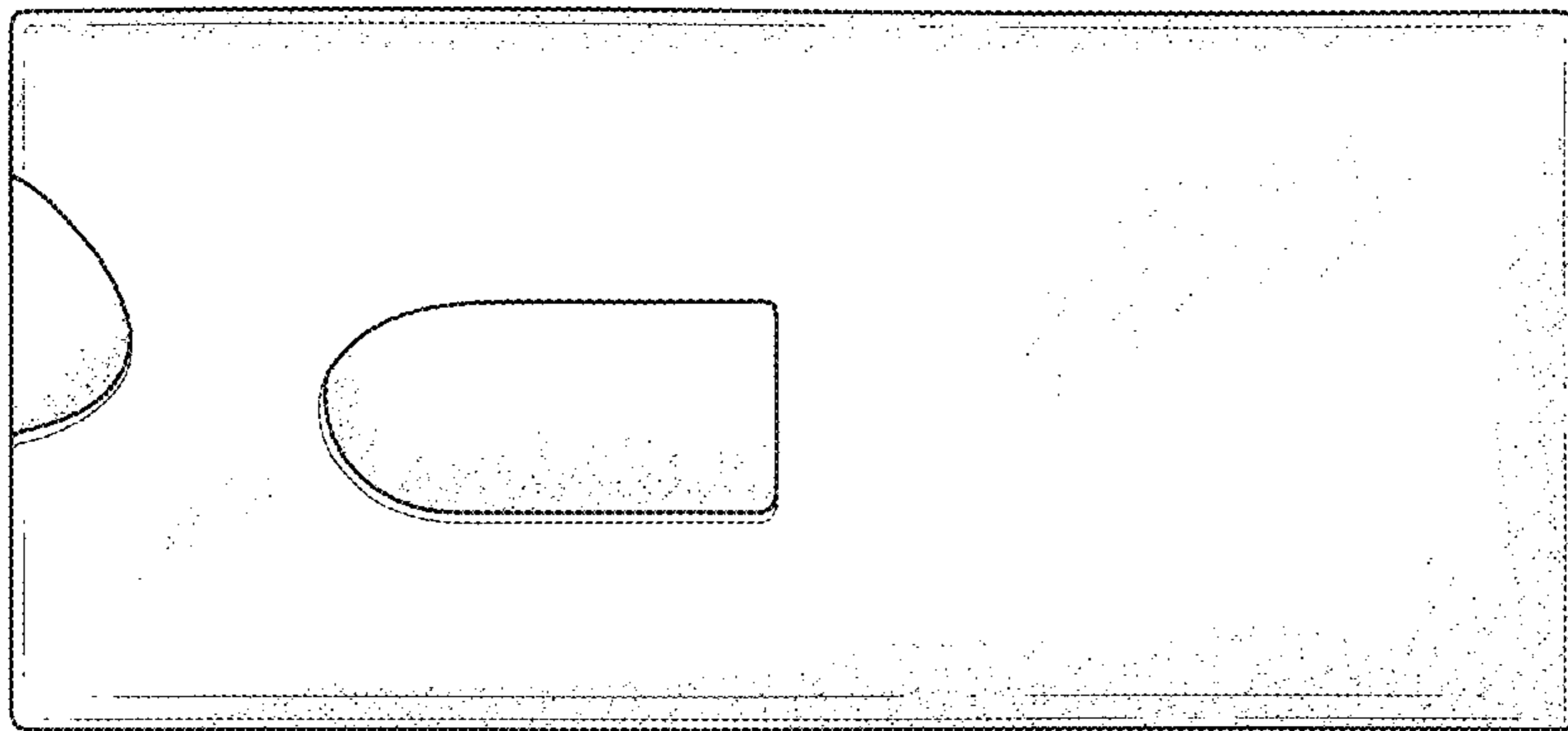

FIG. 4

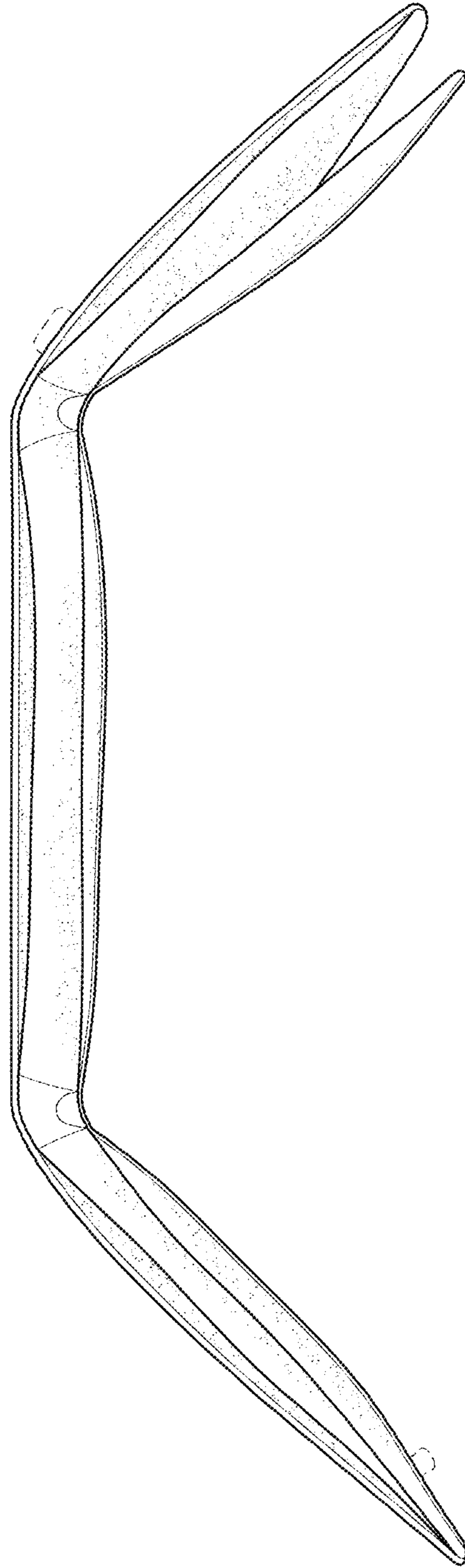

FIG. 6

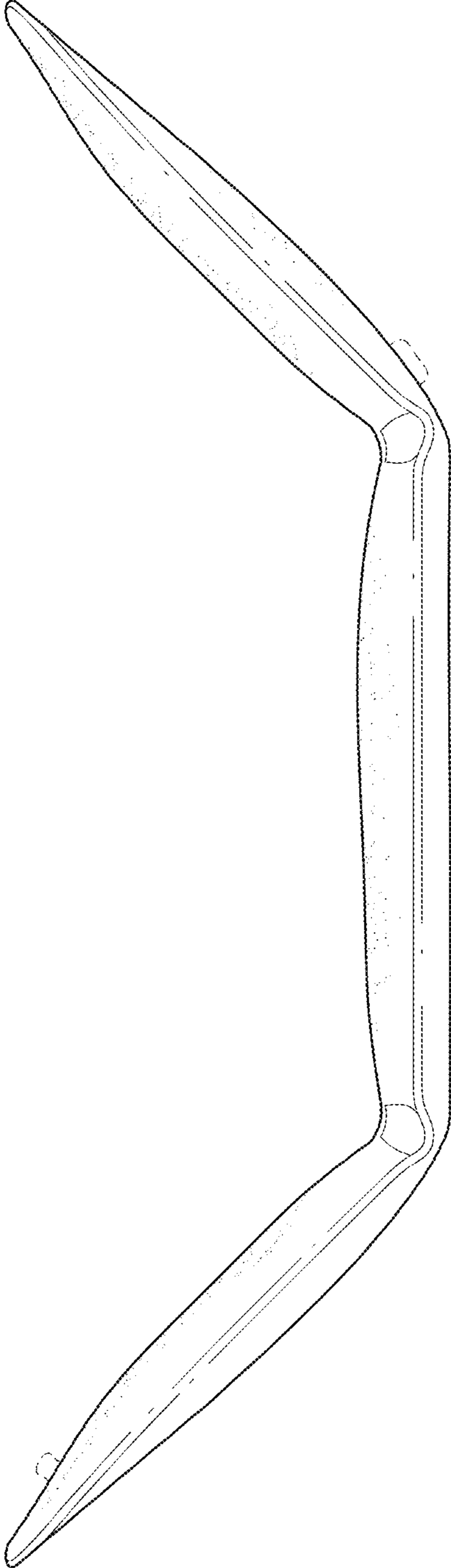

FIG. 7

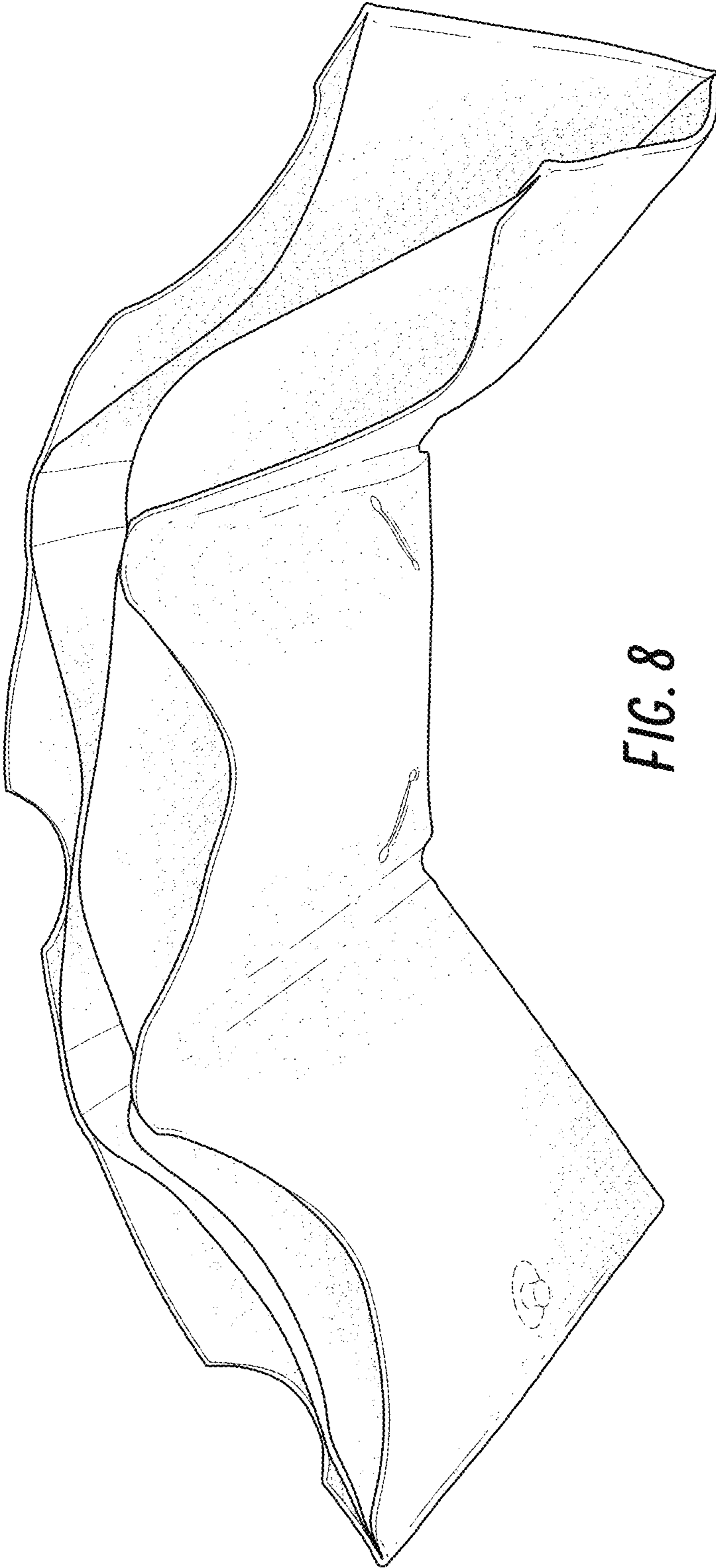

FIG. 8

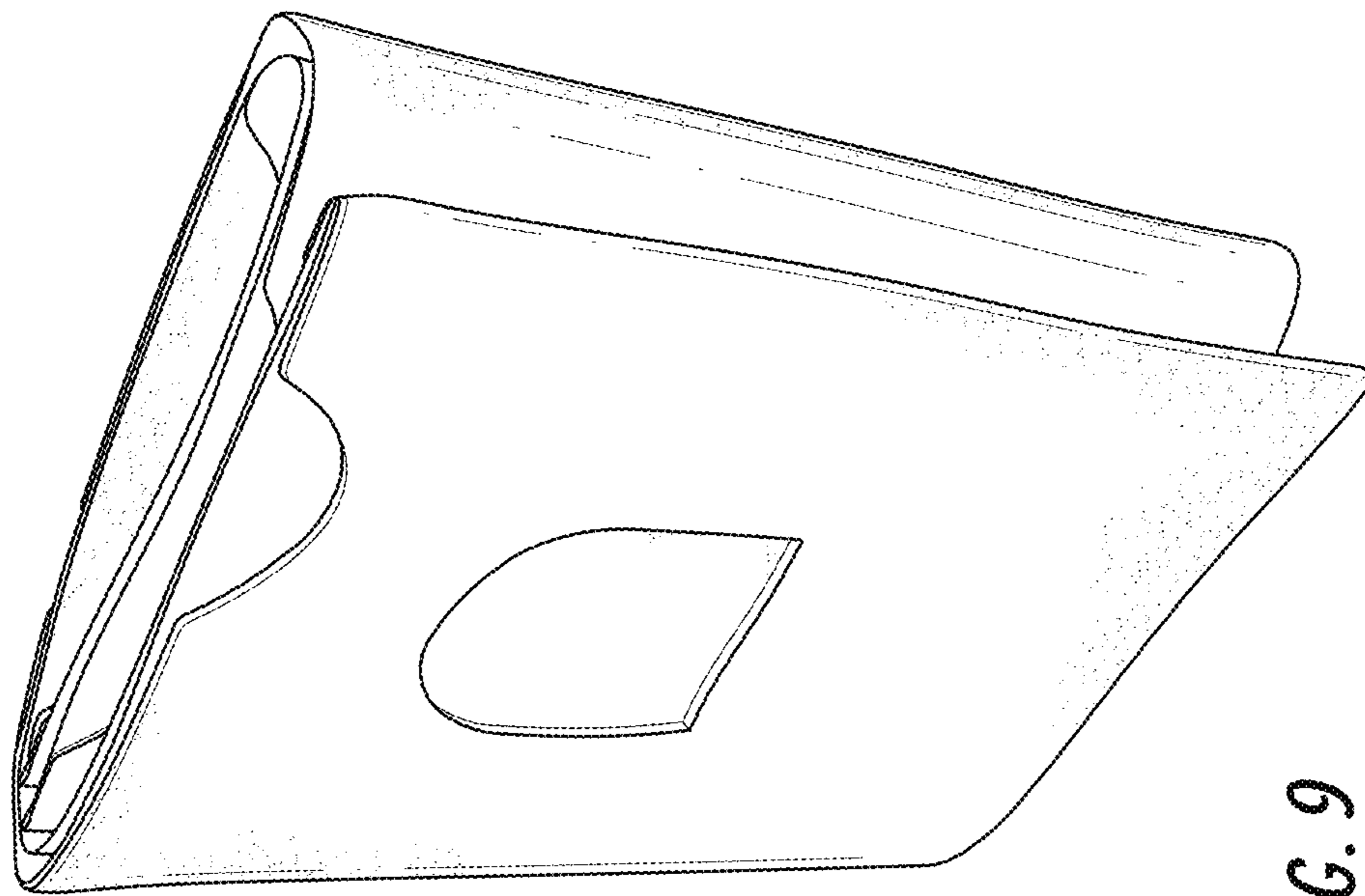

FIG. 9

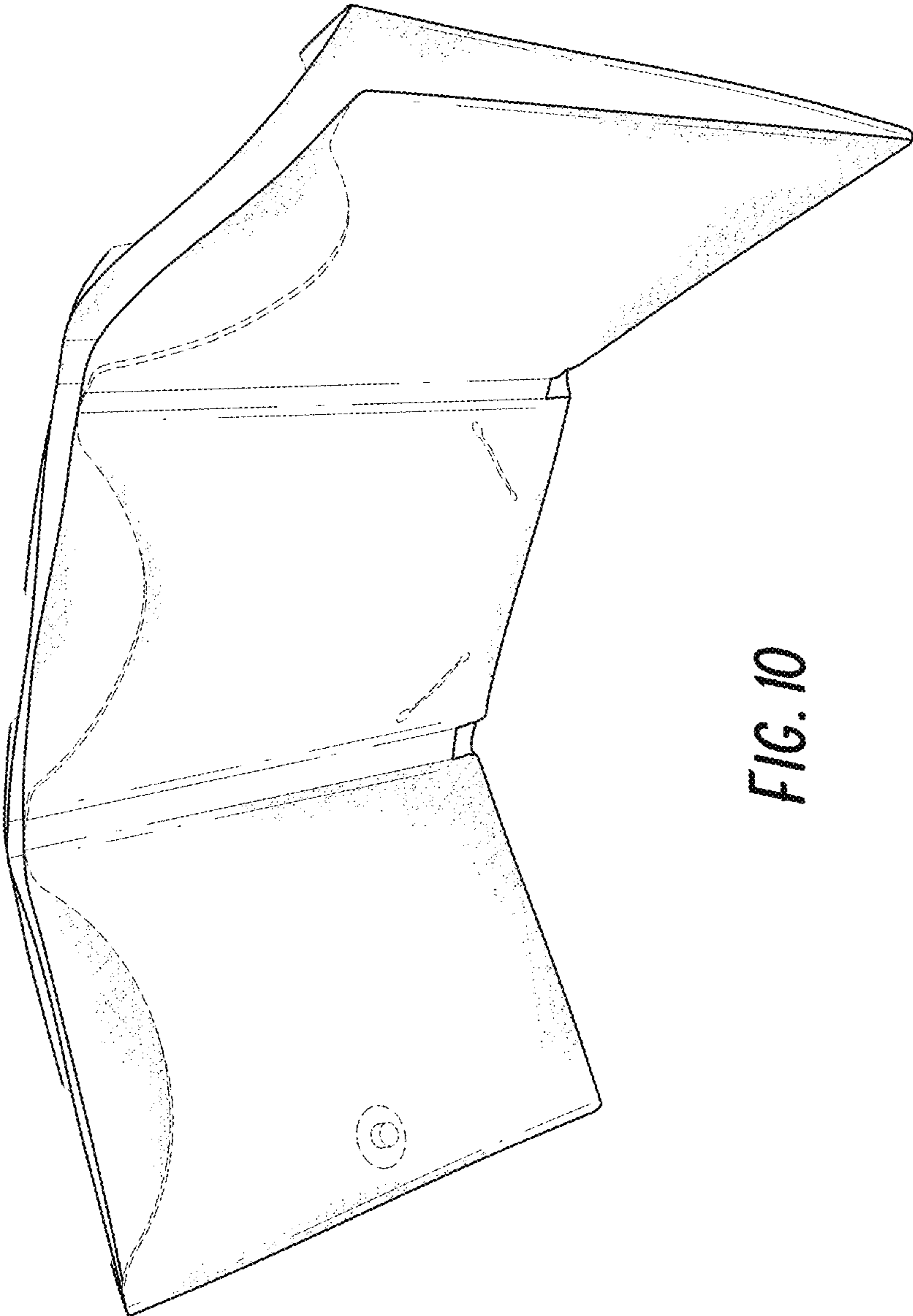

FIG. 10

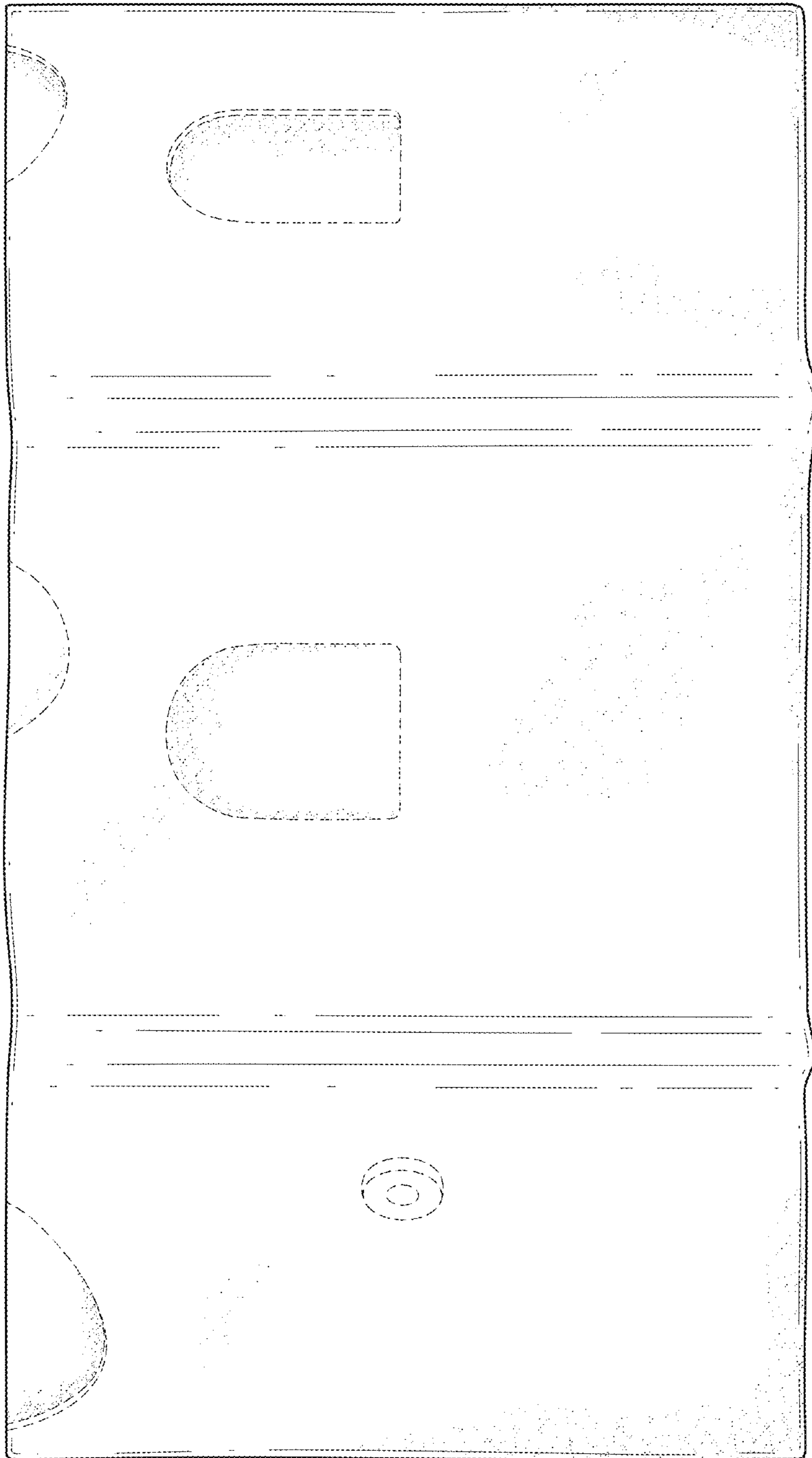

FIG. 11

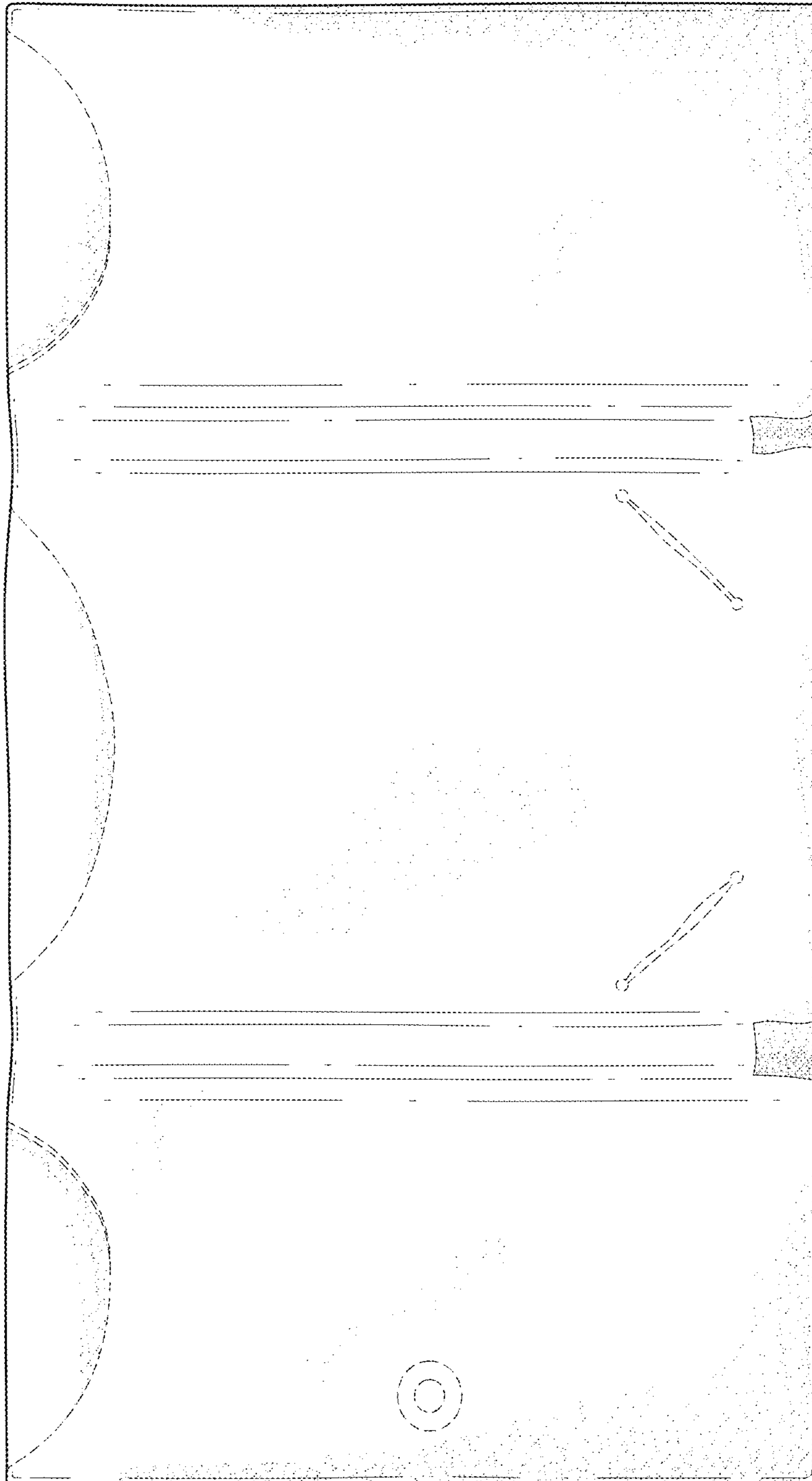

FIG. 12

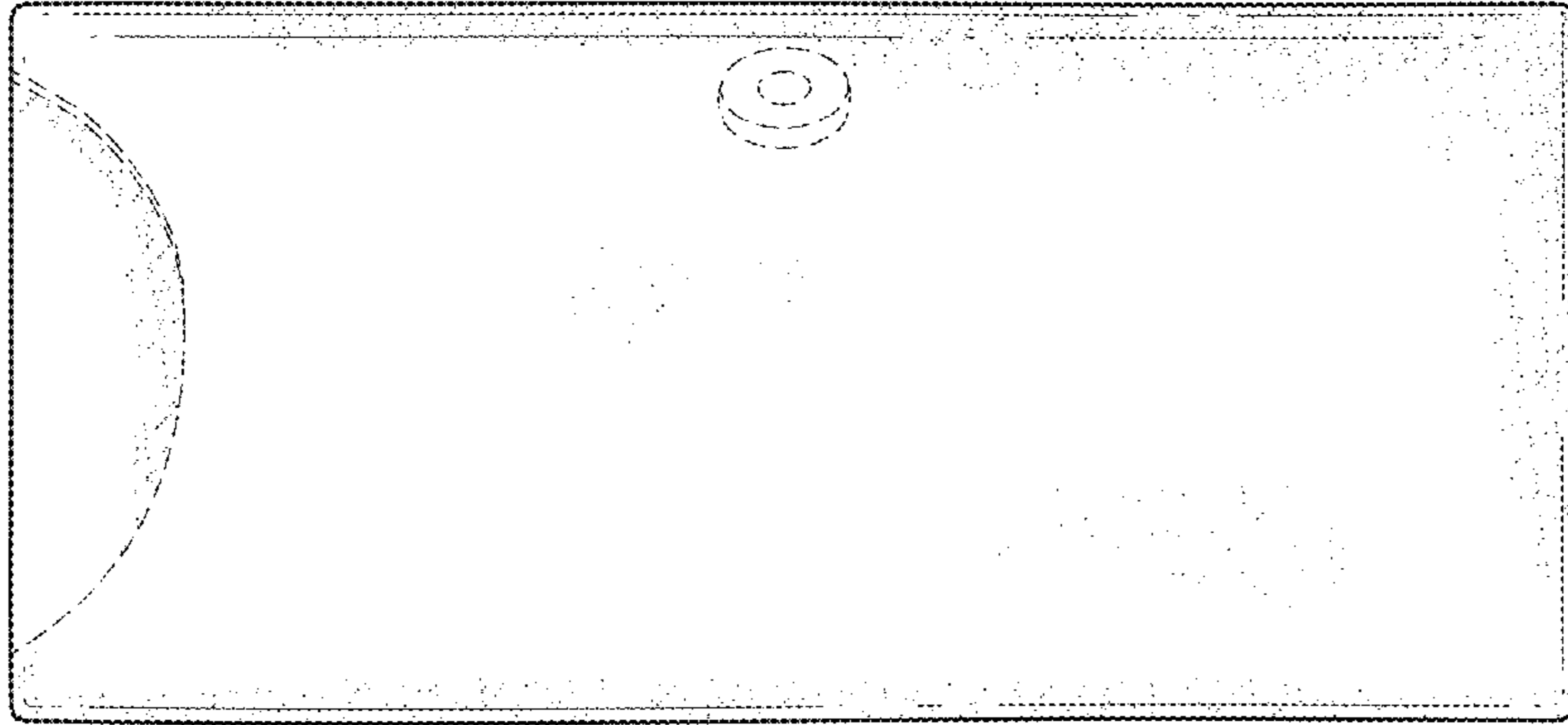

FIG. 14

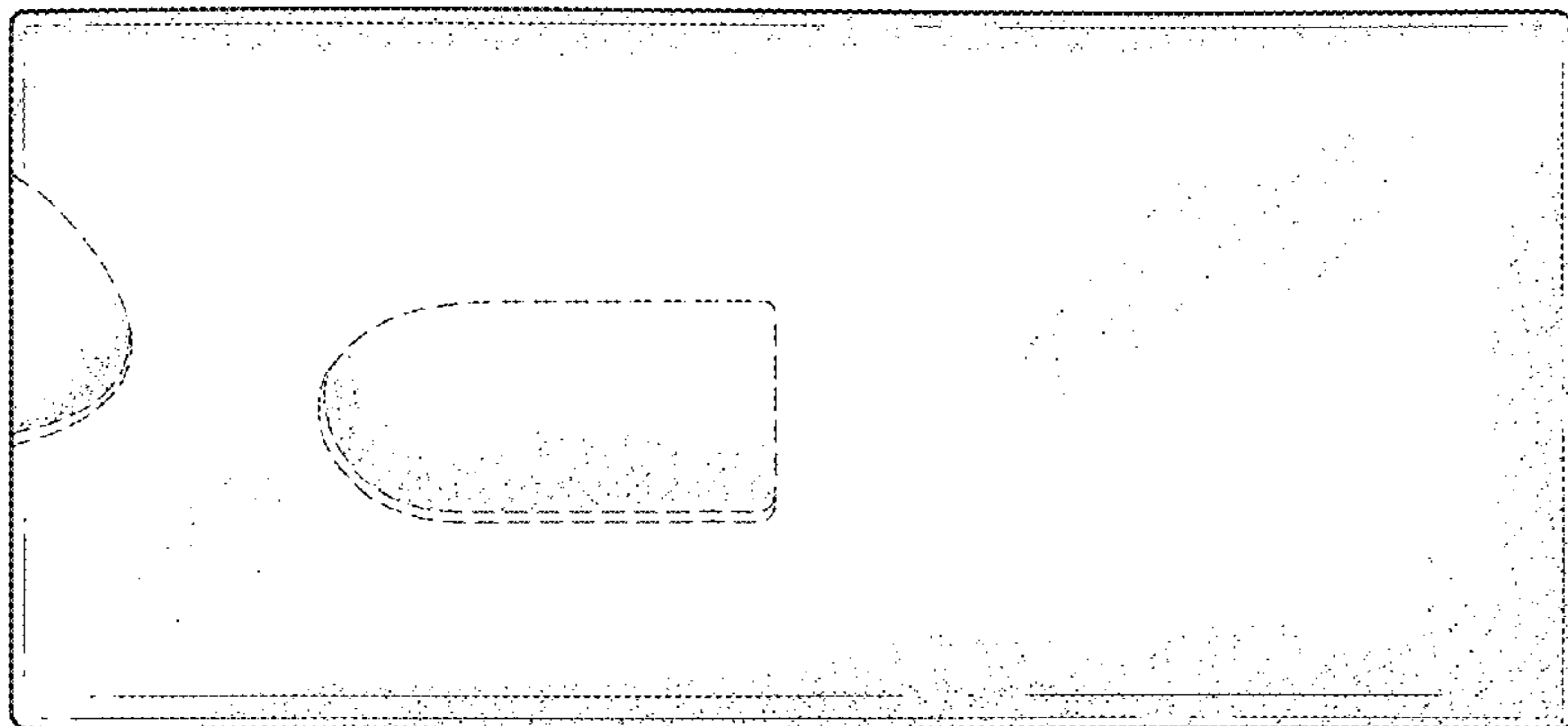

FIG. 13

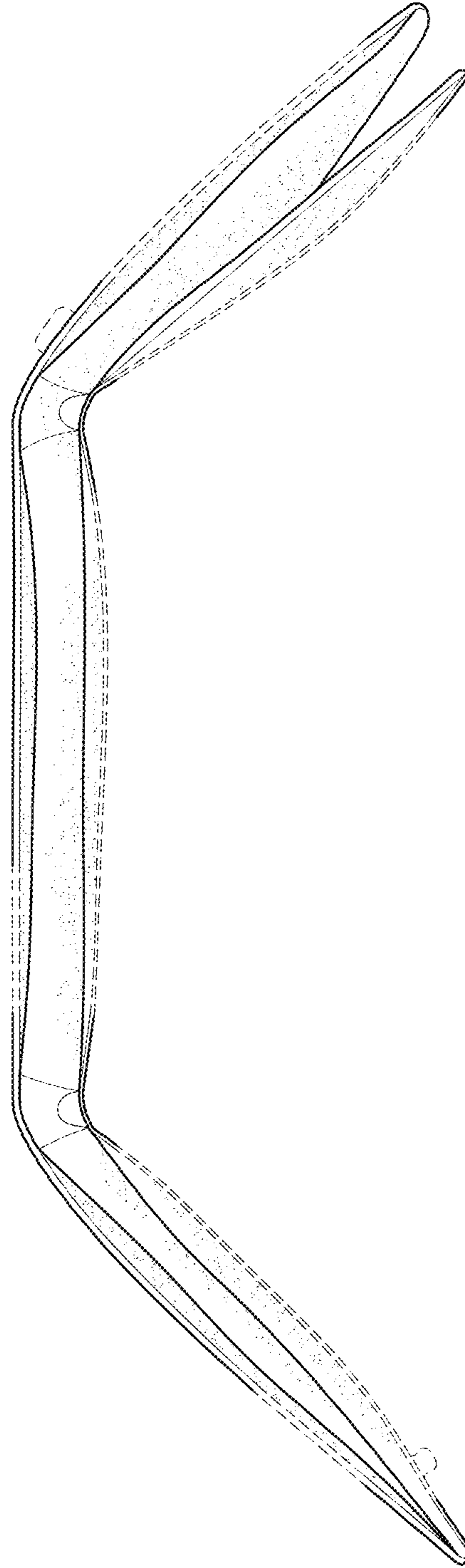

FIG. 15

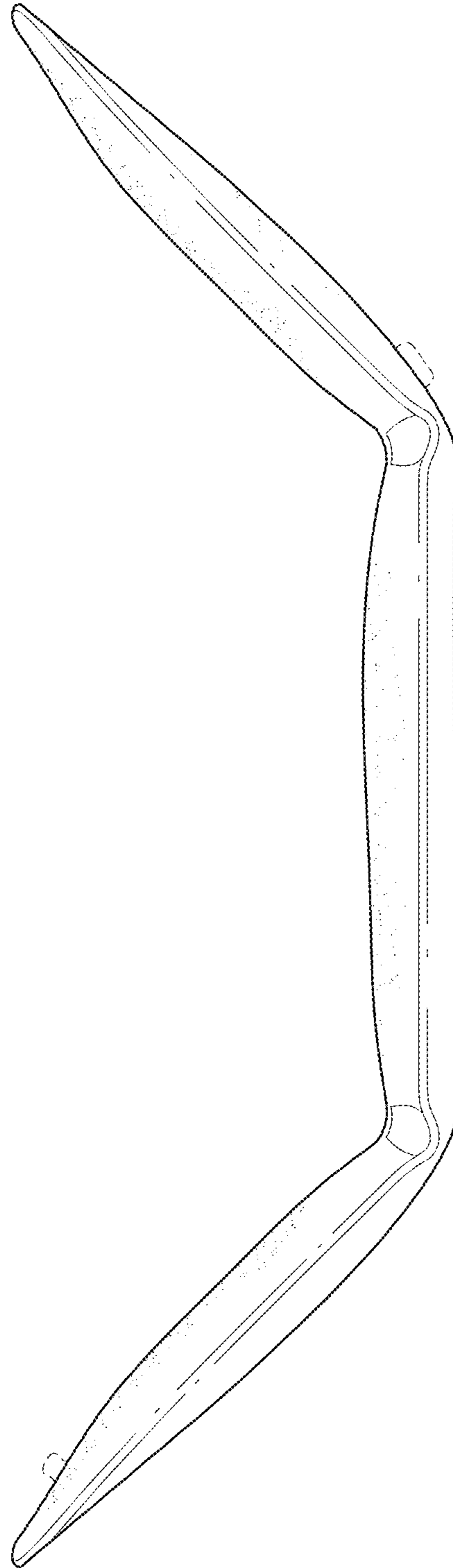

FIG. 16

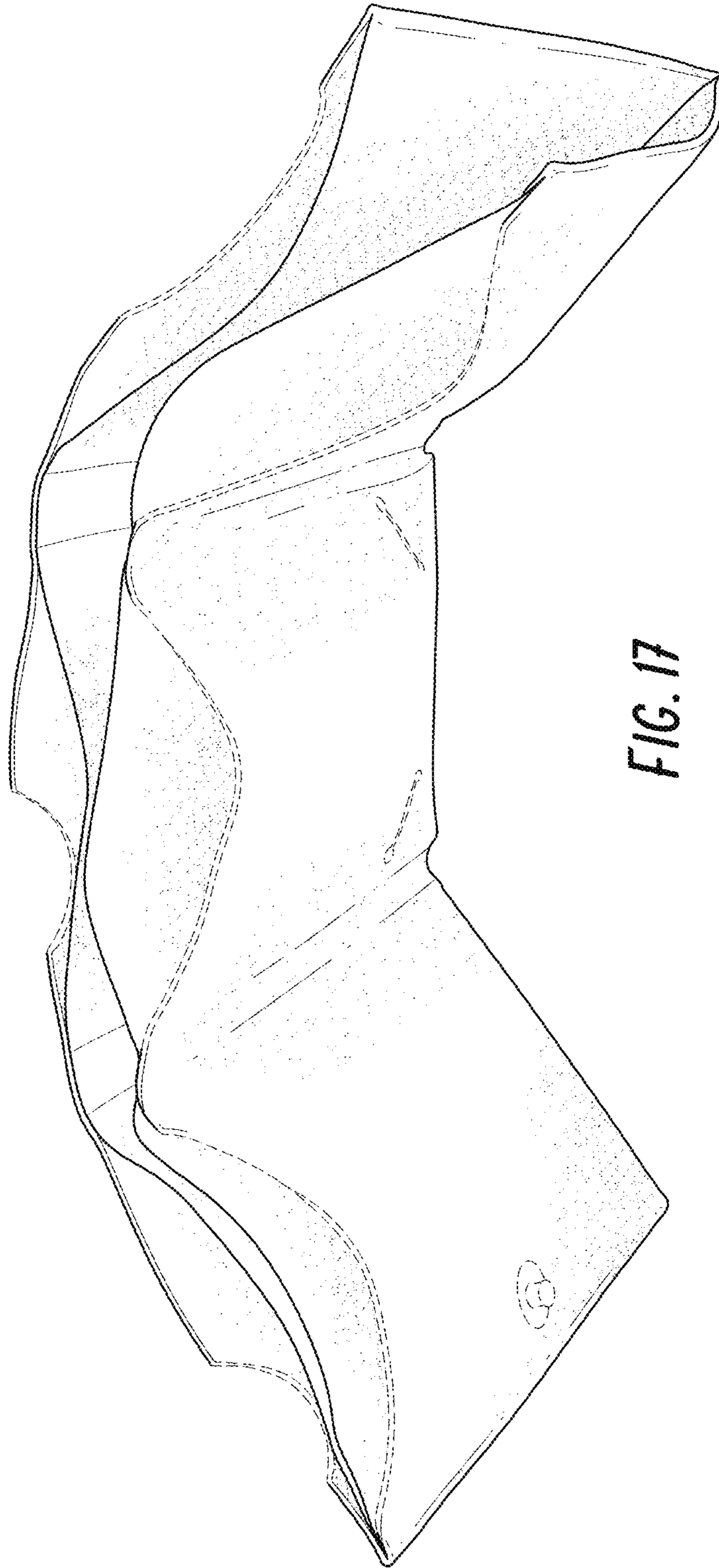

FIG. 17

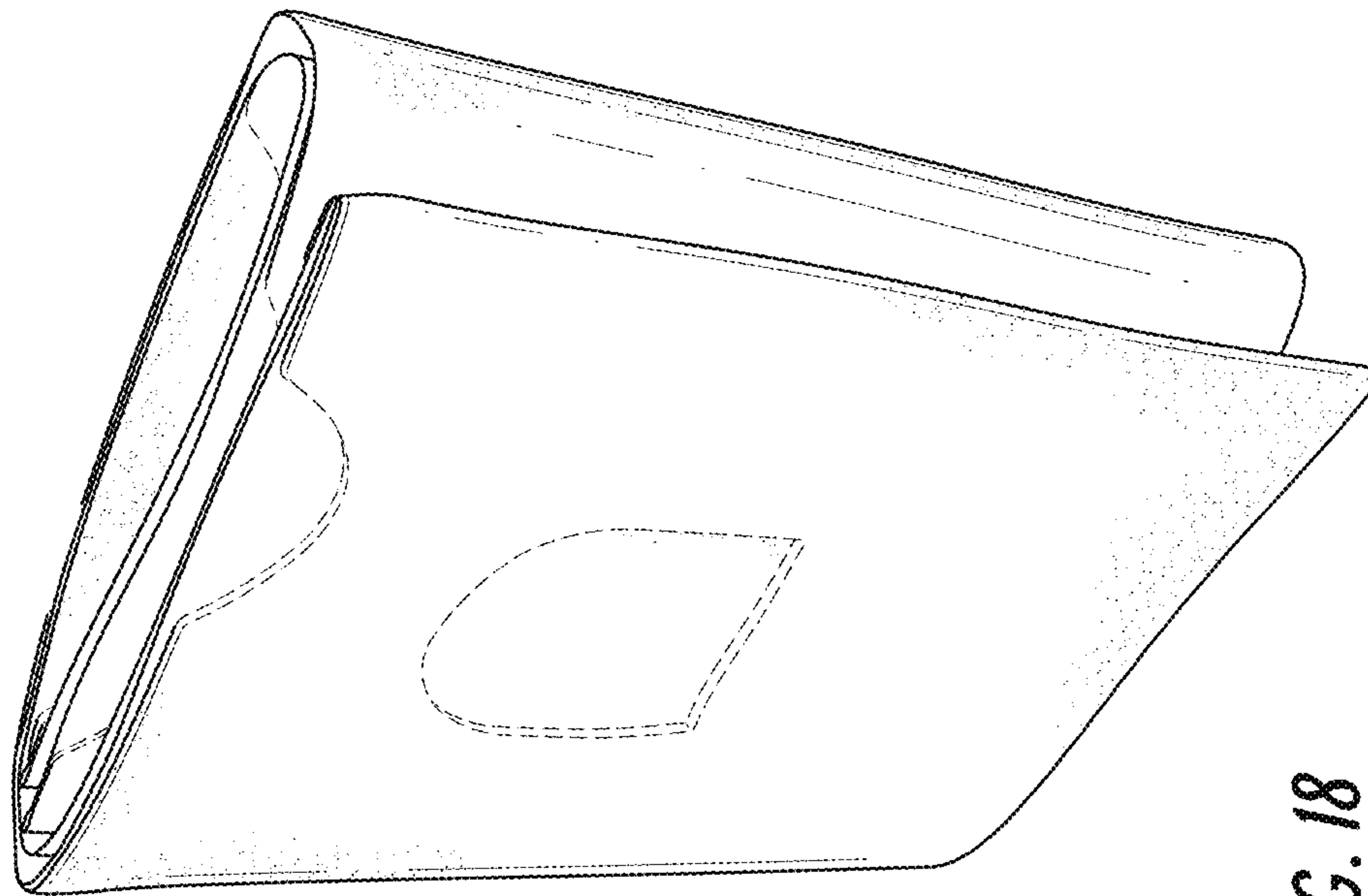

FIG. 18