



US00D822986S

(12) **United States Design Patent**
Viger et al.

(10) **Patent No.:** **US D822,986 S**
(45) **Date of Patent:** **** Jul. 17, 2018**

(54) **MESSENGER BAG**

D722,228 S * 2/2015 Zwetzig D3/232
D742,634 S * 11/2015 Zwetzig D3/232
D758,719 S * 6/2016 Harper D3/232

(71) Applicant: **Peak Design**, San Francisco, CA (US)

* cited by examiner

(72) Inventors: **Arthur Viger**, San Francisco, CA (US);
Peter Dering, San Francisco, CA (US);
Robb Jankura, San Francisco, CA
(US); **Joseph Cunningham**, San
Francisco, CA (US); **Peter Lockett**, San
Francisco, CA (US)

Primary Examiner — Holly H Baynham
(74) *Attorney, Agent, or Firm* — Grumbles Law PLLC;
Brittany Nanzig; Paul Feng

(73) Assignee: **Peak Design**, San Francisco, CA (US)

(57) **CLAIM**

The ornamental design for a messenger bag, as shown and described.

(**) Term: **15 Years**

DESCRIPTION

(21) Appl. No.: **29/569,596**

FIG. 1 is a perspective front view of a messenger bag showing our new design.

(22) Filed: **Jun. 29, 2016**

FIG. 2 is a perspective back view of the messenger bag.

(51) **LOC (11) Cl.** **03-01**

FIG. 3 is a front elevational view of the messenger bag.

(52) **U.S. Cl.**

FIG. 4 is a back elevational view of the messenger bag.

USPC **D3/246**

FIG. 5 is a top elevational view of the messenger bag.

(58) **Field of Classification Search**

USPC D3/232–233, 240–243, 245–246

FIG. 6 is a bottom elevational view of the messenger bag.

CPC A45C 1/024; A45C 3/06

FIG. 7 is a left side elevational view of the messenger bag.

See application file for complete search history.

FIG. 8 is a right side elevational view of the messenger bag.

(56) **References Cited**

FIG. 9 is a front elevational view of the messenger bag in an open position; and,

U.S. PATENT DOCUMENTS

FIG. 10 is a back elevational view of the messenger bag in an open position.

6,206,567 B1 3/2001 Cyr
D520,747 S * 5/2006 McClain D3/290
D651,794 S * 1/2012 Hargens D3/232

The lighter broken lines depict stitching and are part of the claimed design. The bold broken lines showing the zipper pull are for the purposes of illustrating environment and form no part of the claimed design.

1 Claim, 7 Drawing Sheets

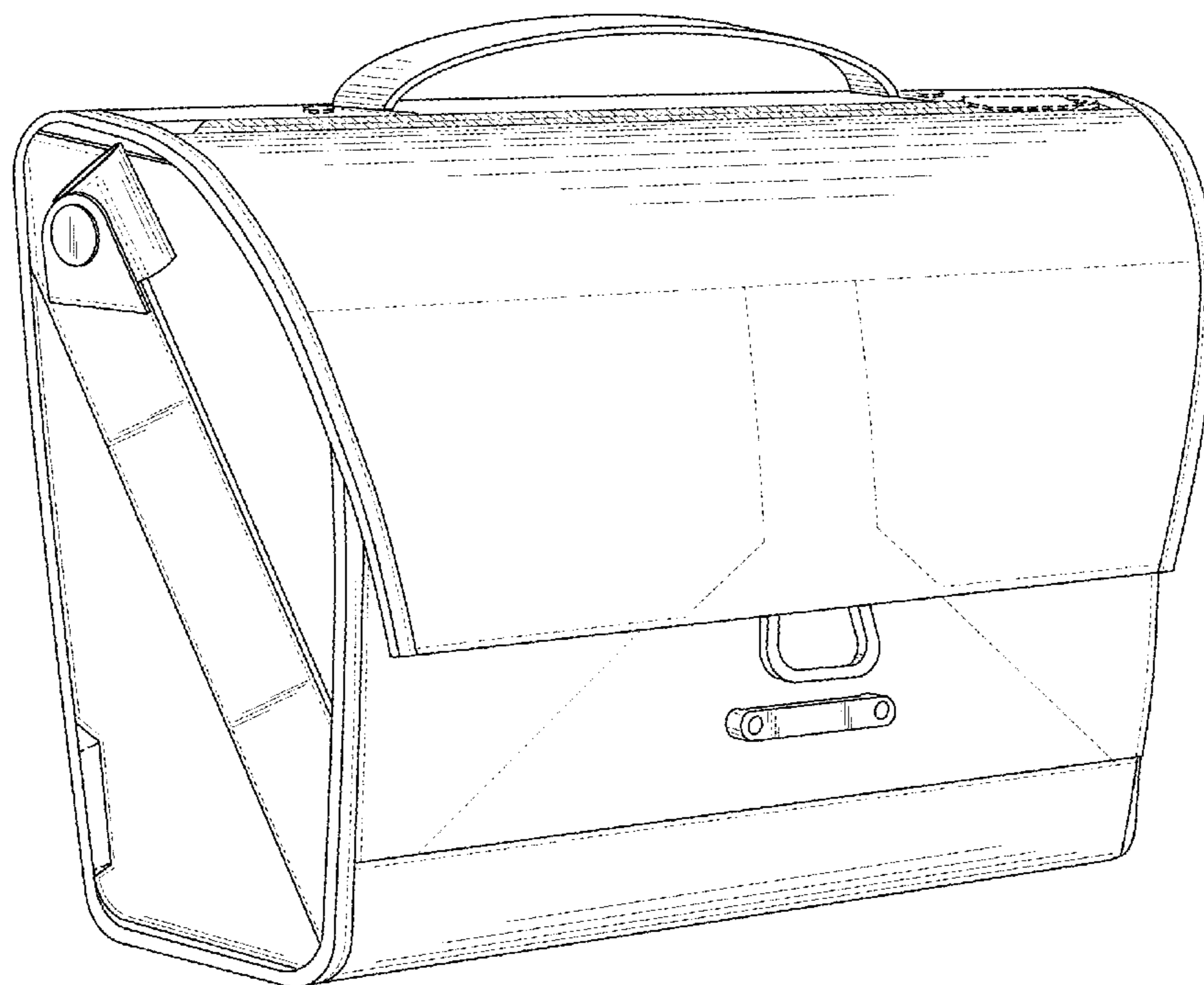



FIG. 1

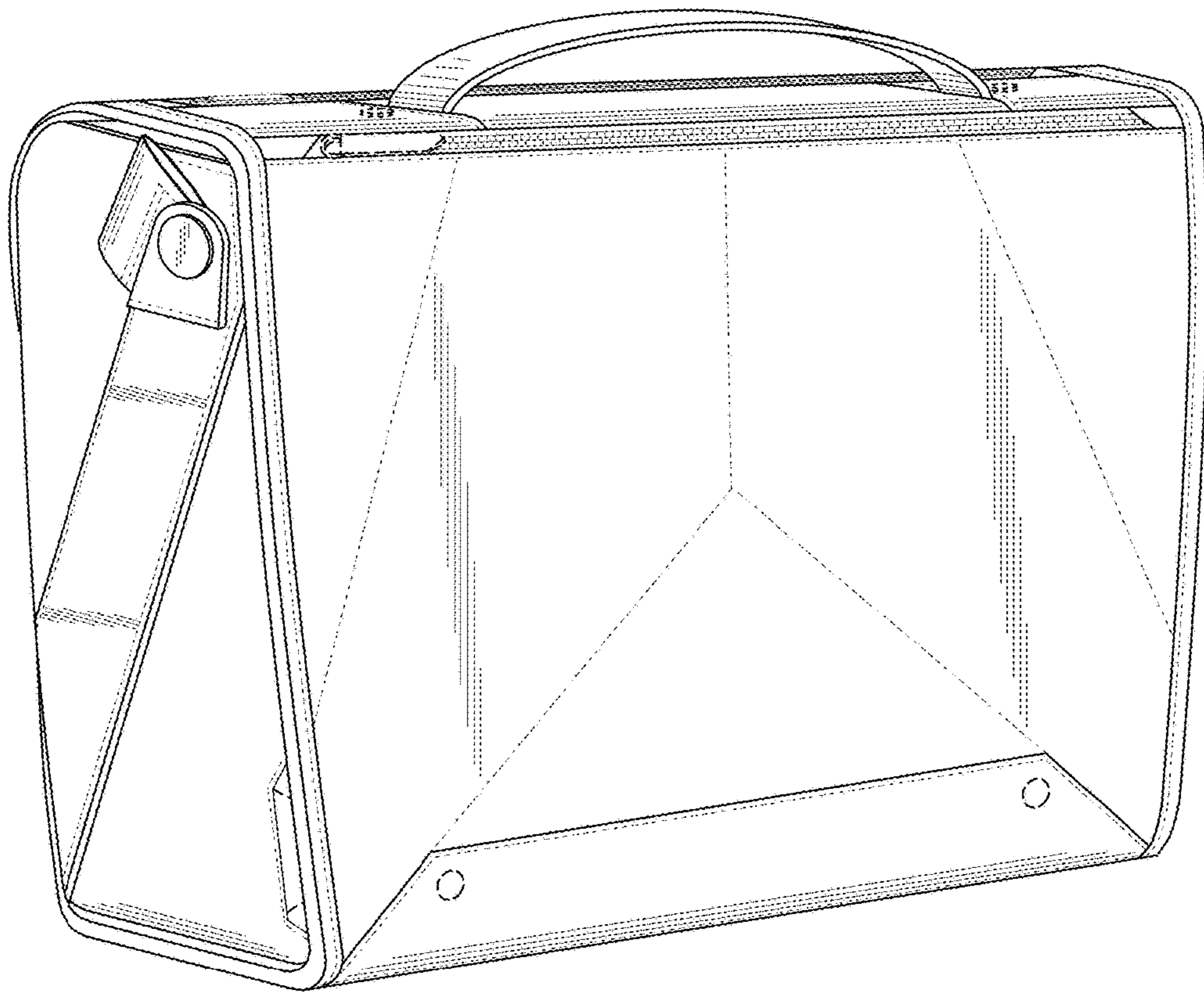

FIG. 2

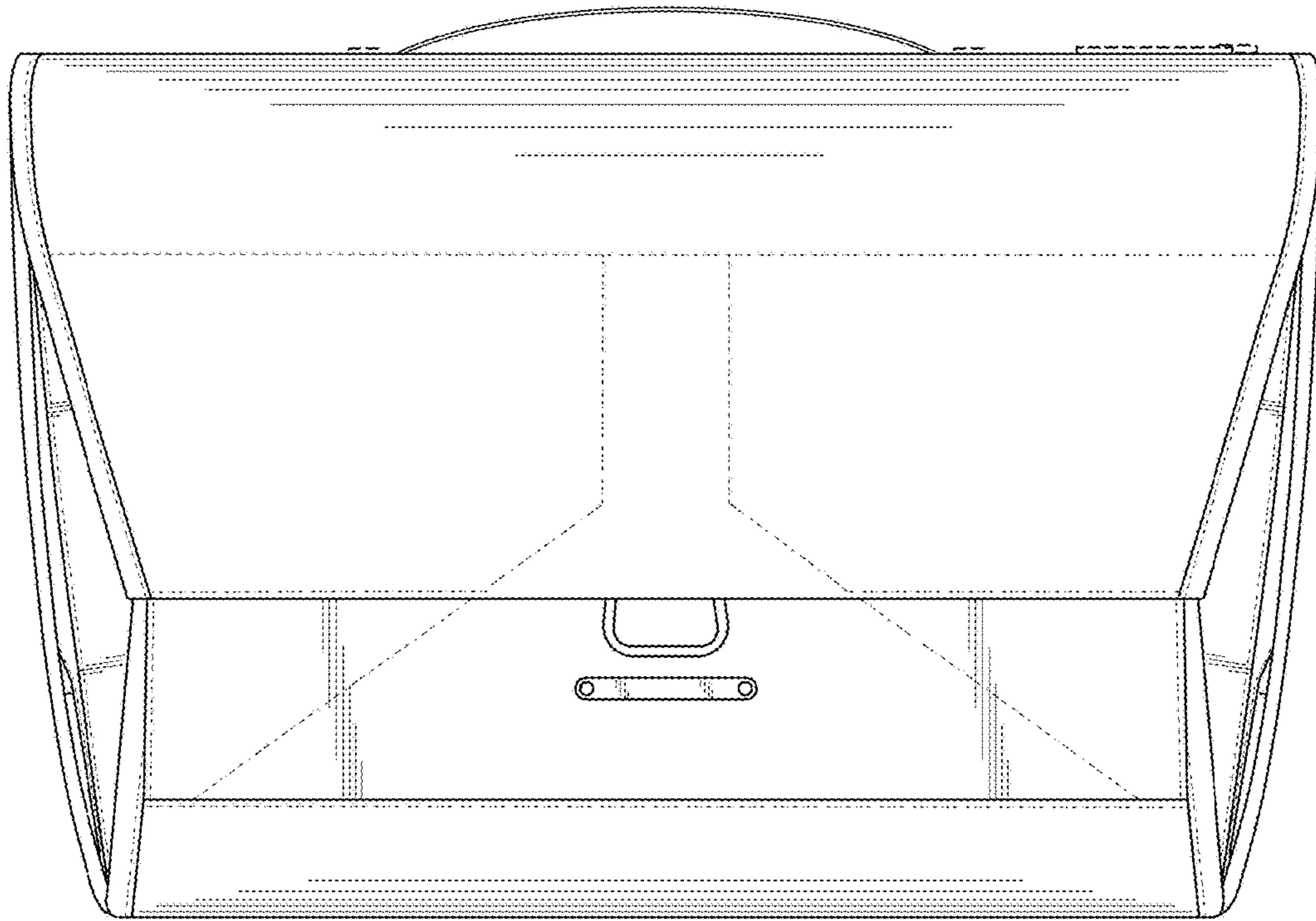

FIG. 3

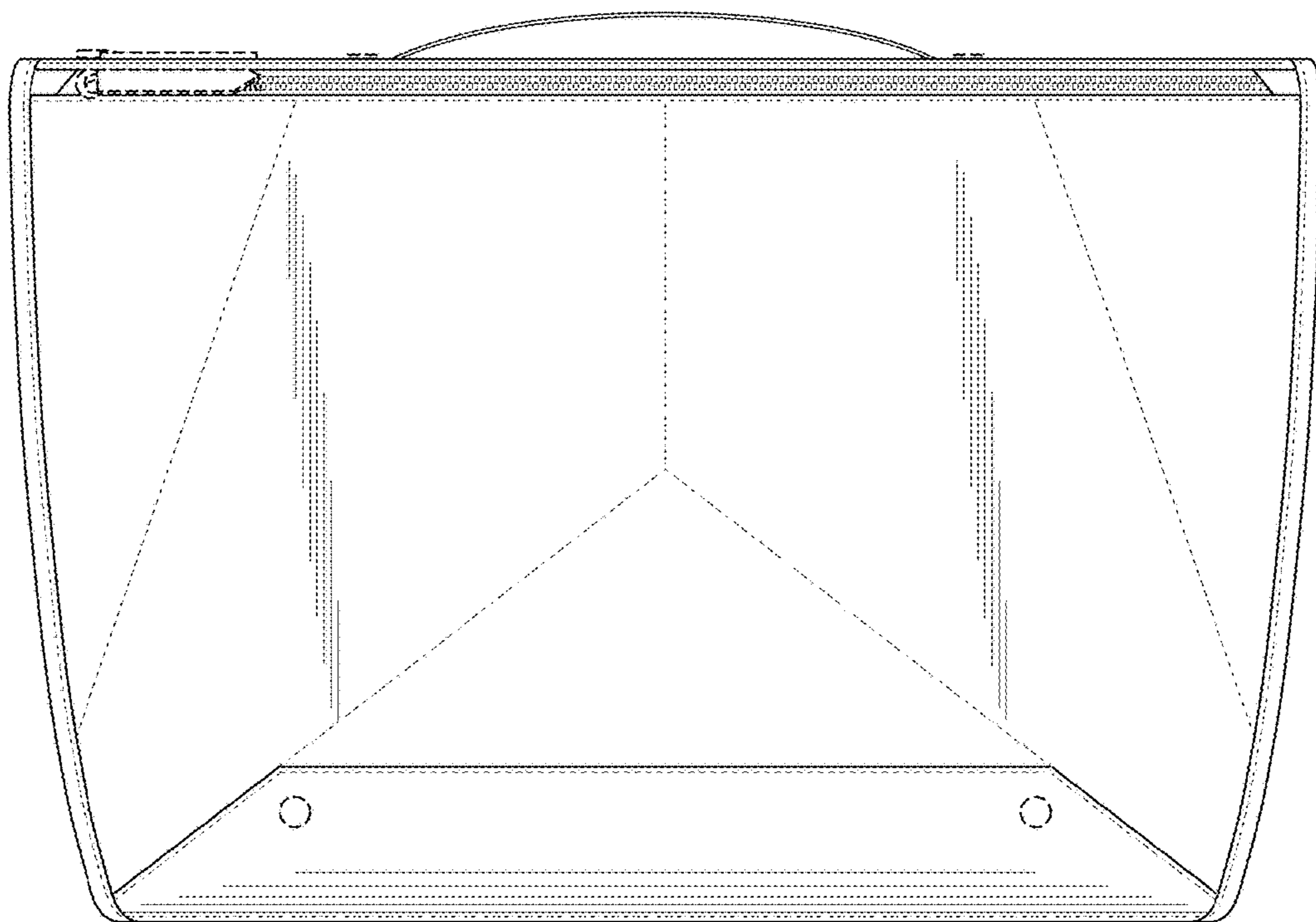

FIG. 4

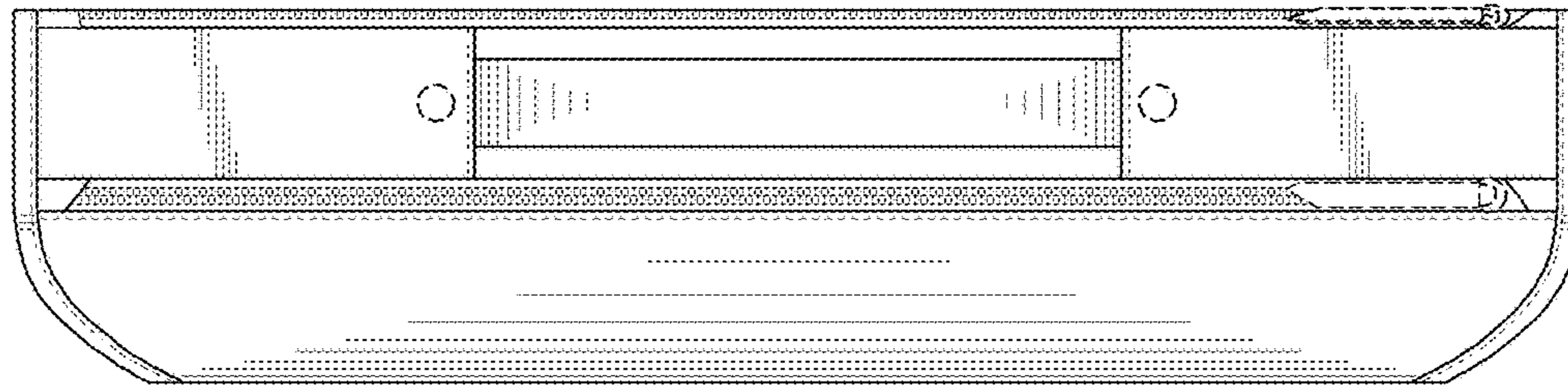

FIG. 5

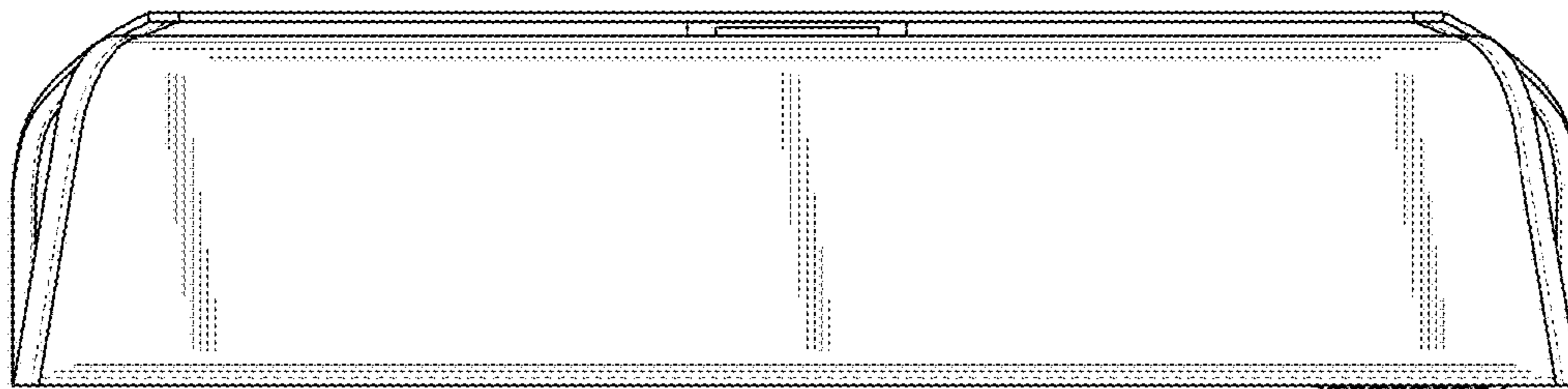

FIG. 6

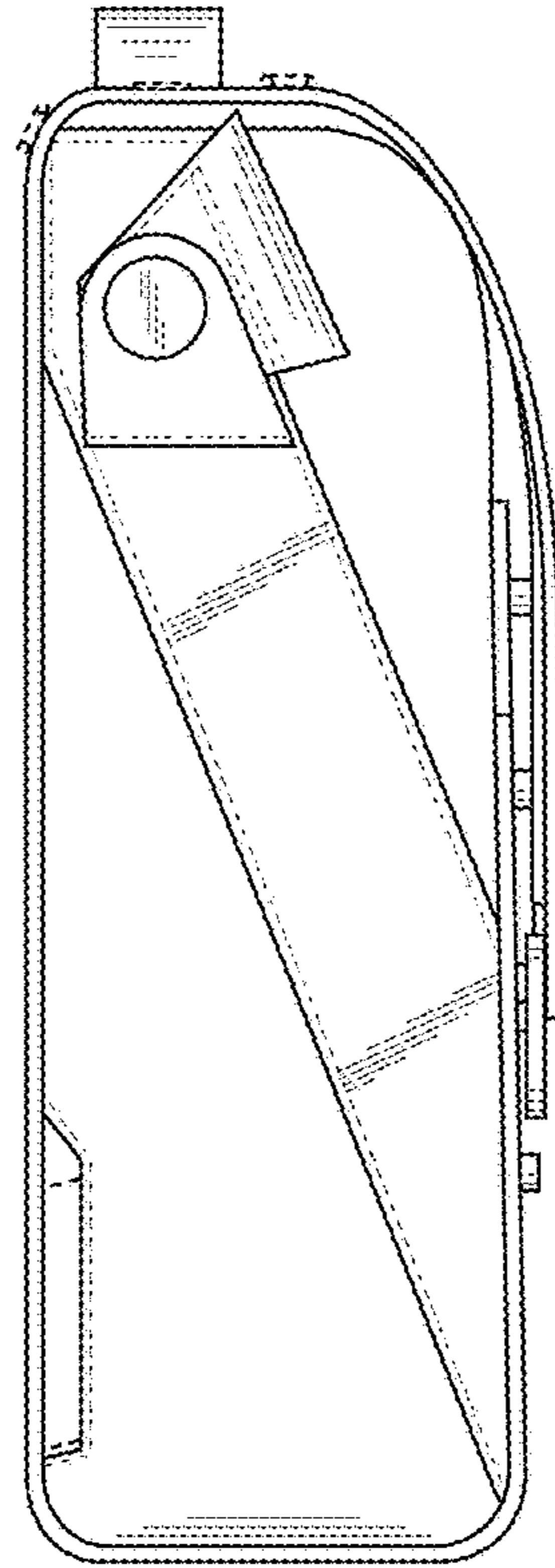

FIG. 7

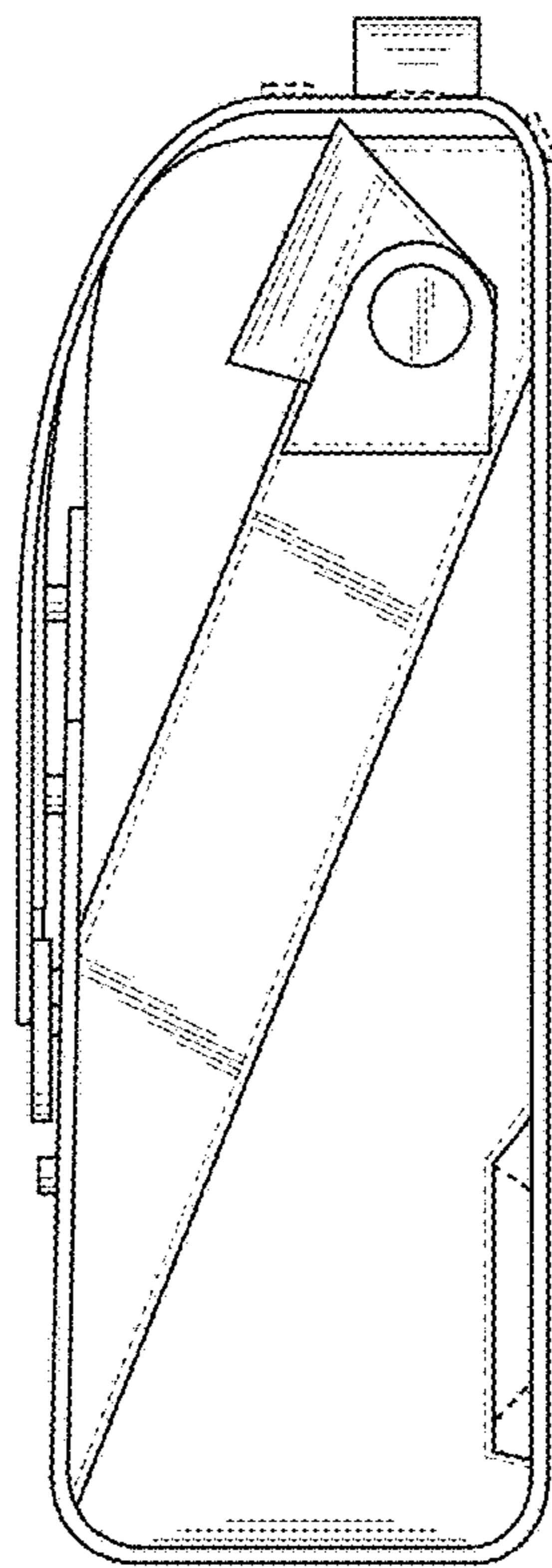

FIG. 8

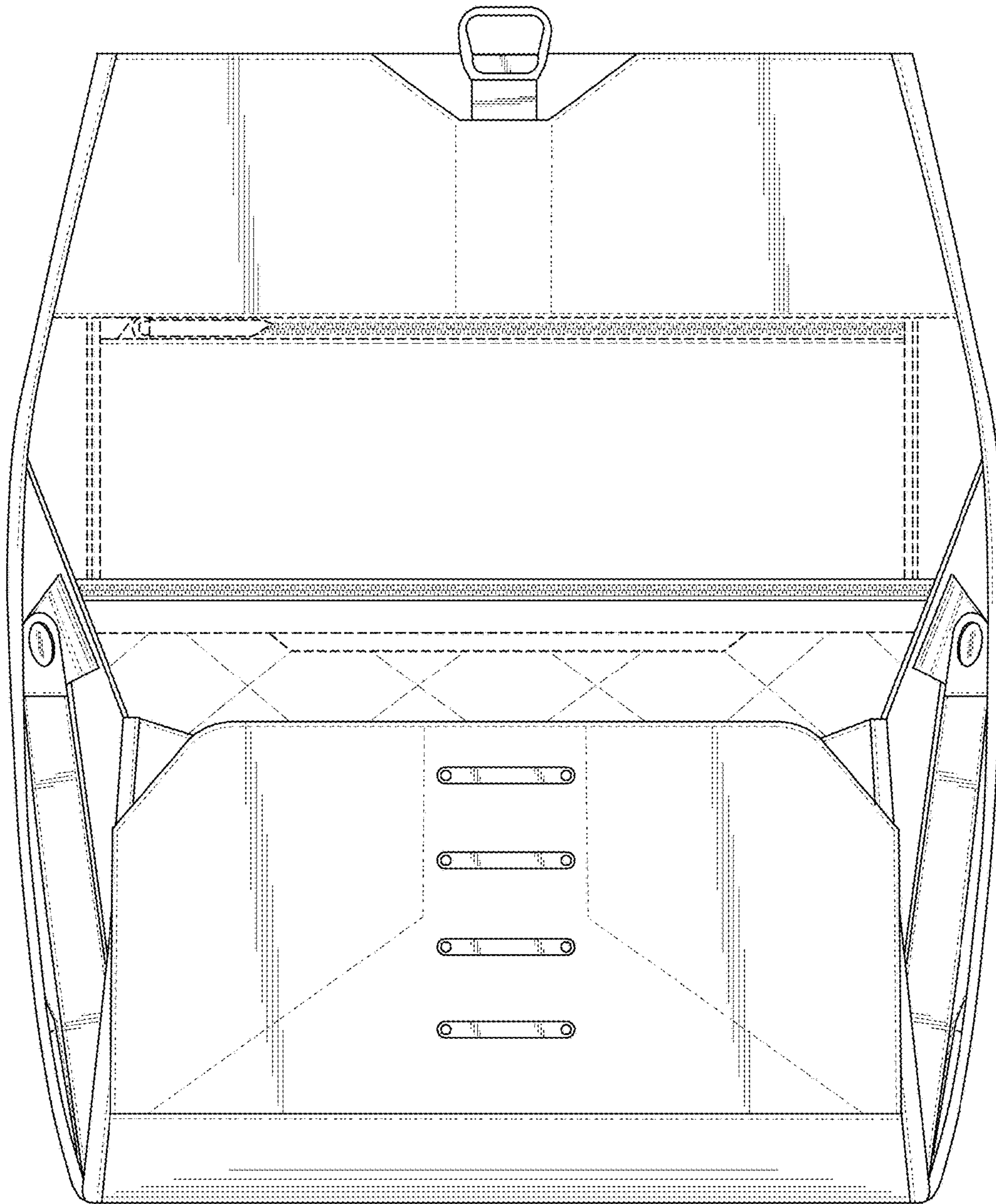

FIG. 9

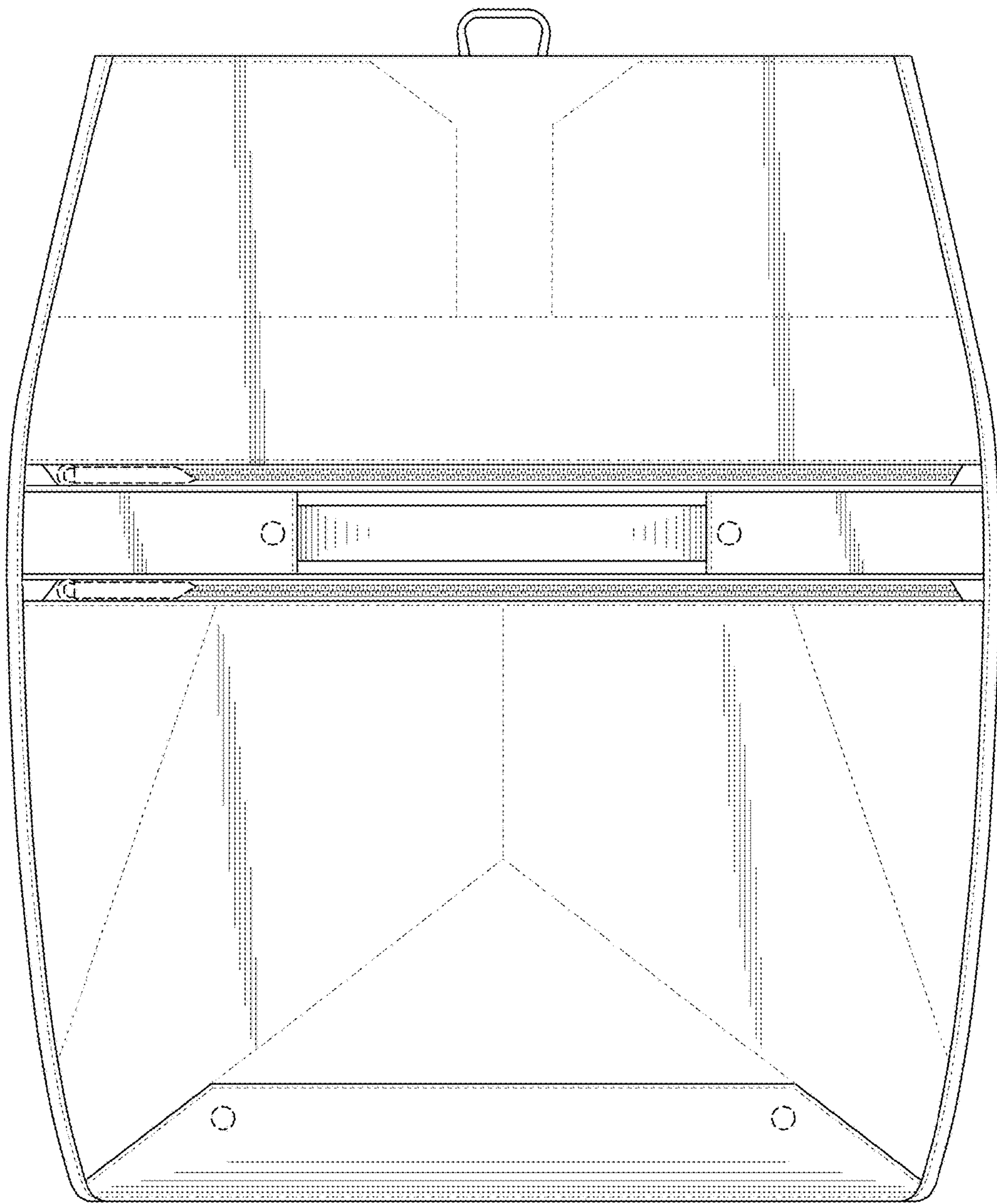

FIG. 10