



US00D822933S

(12) **United States Design Patent**  
**Hoon**

(10) **Patent No.:** **US D822,933 S**  
(45) **Date of Patent:** **\*\* Jul. 10, 2018**

(54) **GARBAGE CONTAINER**  
(71) Applicant: **NLT KOREA CO., LTD**, Seoul (KR)  
(72) Inventor: **Kim Seong Hoon**, Seoul (KR)  
(73) Assignee: **NLT KOREA CO., LTD.**, Seoul (KR)  
(\*\*) Term: **15 Years**  
(21) Appl. No.: **35/503,011**  
(22) Filed: **Nov. 15, 2016**

D652,189 S \* 1/2012 Morand ..... D34/7  
D665,141 S \* 8/2012 Cataldo ..... D34/7  
8,678,219 B1 \* 3/2014 Wang ..... B65F 1/163  
220/211  
D712,611 S \* 9/2014 Sun Ting Kung ..... D34/1  
D716,015 S \* 10/2014 van de Leest ..... D34/9  
D730,008 S \* 5/2015 Yang ..... D34/9  
D758,686 S \* 6/2016 Beumer ..... D34/8  
D765,937 S \* 9/2016 Chen ..... D34/7  
D798,016 S \* 9/2017 Yang ..... D34/9  
9,751,692 B2 \* 9/2017 Yang ..... B65F 1/1638  
9,790,025 B2 \* 10/2017 Yang ..... B65F 1/04  
9,856,080 B2 \* 1/2018 Yang ..... B65F 1/1638

\* cited by examiner

(80) **Hague Agreement Data**  
Int. Filing Date: **Nov. 15, 2016**  
Int. Reg. No.: **DM/094265**  
Int. Reg. Date: **Nov. 15, 2016**  
Int. Reg. Pub. Date: **May 19, 2017**

*Primary Examiner* — Michael A. Pratt  
(74) *Attorney, Agent, or Firm* — IPLA P.A.; James E. Bame

(51) **LOC (11) Cl.** ..... **09-09**  
(52) **U.S. Cl.**  
USPC ..... **D34/9**

(57) **CLAIM**

The ornamental design for a garbage container, as shown and described.

(58) **Field of Classification Search**  
USPC ..... D34/1, 5, 6, 7, 8, 10, 11  
CPC ..... E05D 3/02; E05D 11/00; E05D 13/12;  
E05D 1/00; E05D 2011/0072; E05D 5/10;  
B65F 1/16; Y10S 220/908  
See application file for complete search history.

**DESCRIPTION**

- 1. Garbage container
- 1.1 : Back
- 1.2 : Perspective
- 1.3 : Right
- 1.4 : Bottom
- 1.5 : Front
- 1.6 : Left
- 1.7 : Top

(56) **References Cited**  
U.S. PATENT DOCUMENTS  
D578,722 S \* 10/2008 Yang ..... D34/9  
D611,216 S \* 3/2010 Yang ..... D34/7

**1 Claim, 7 Drawing Sheets**

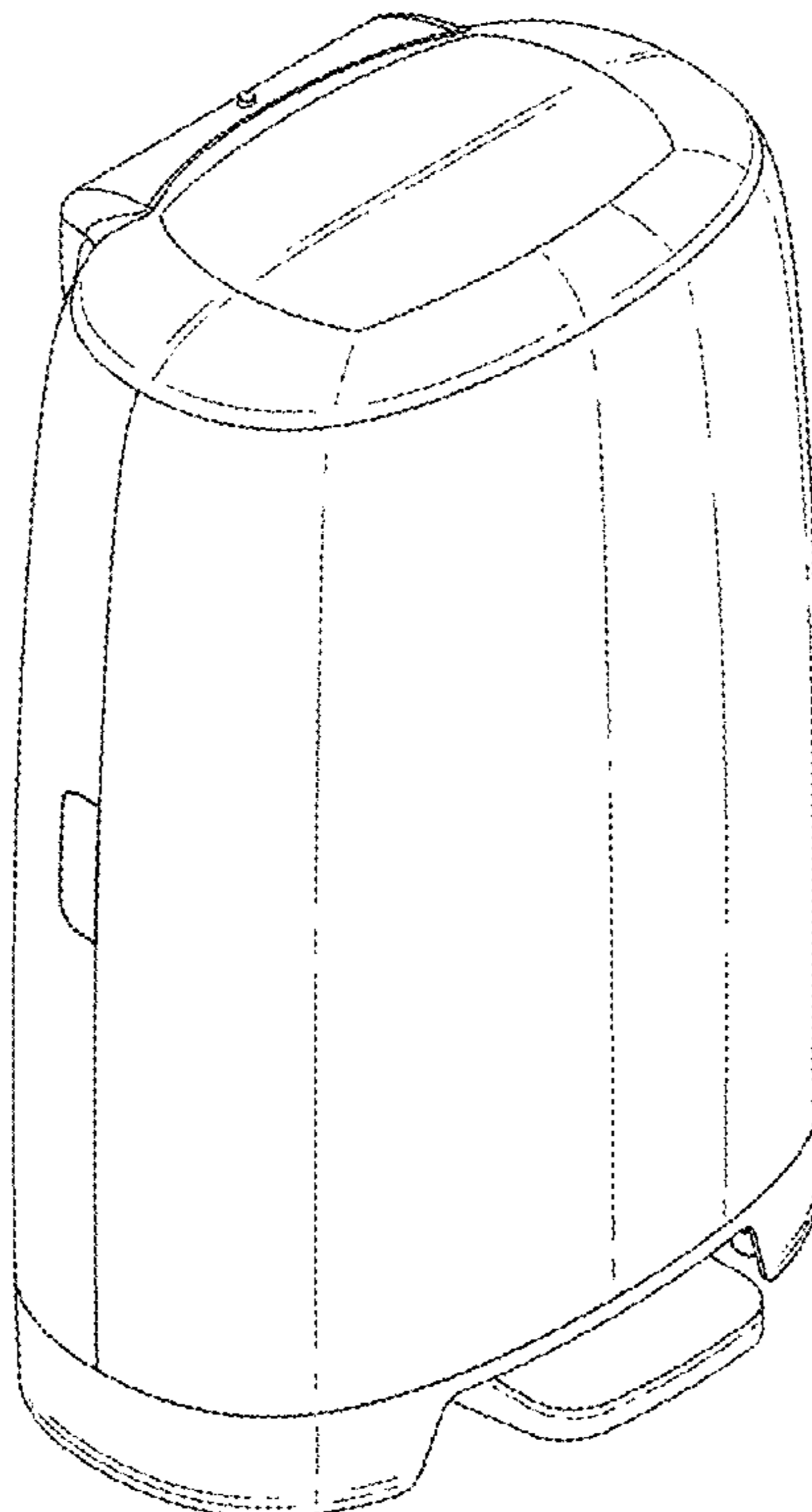

1.1

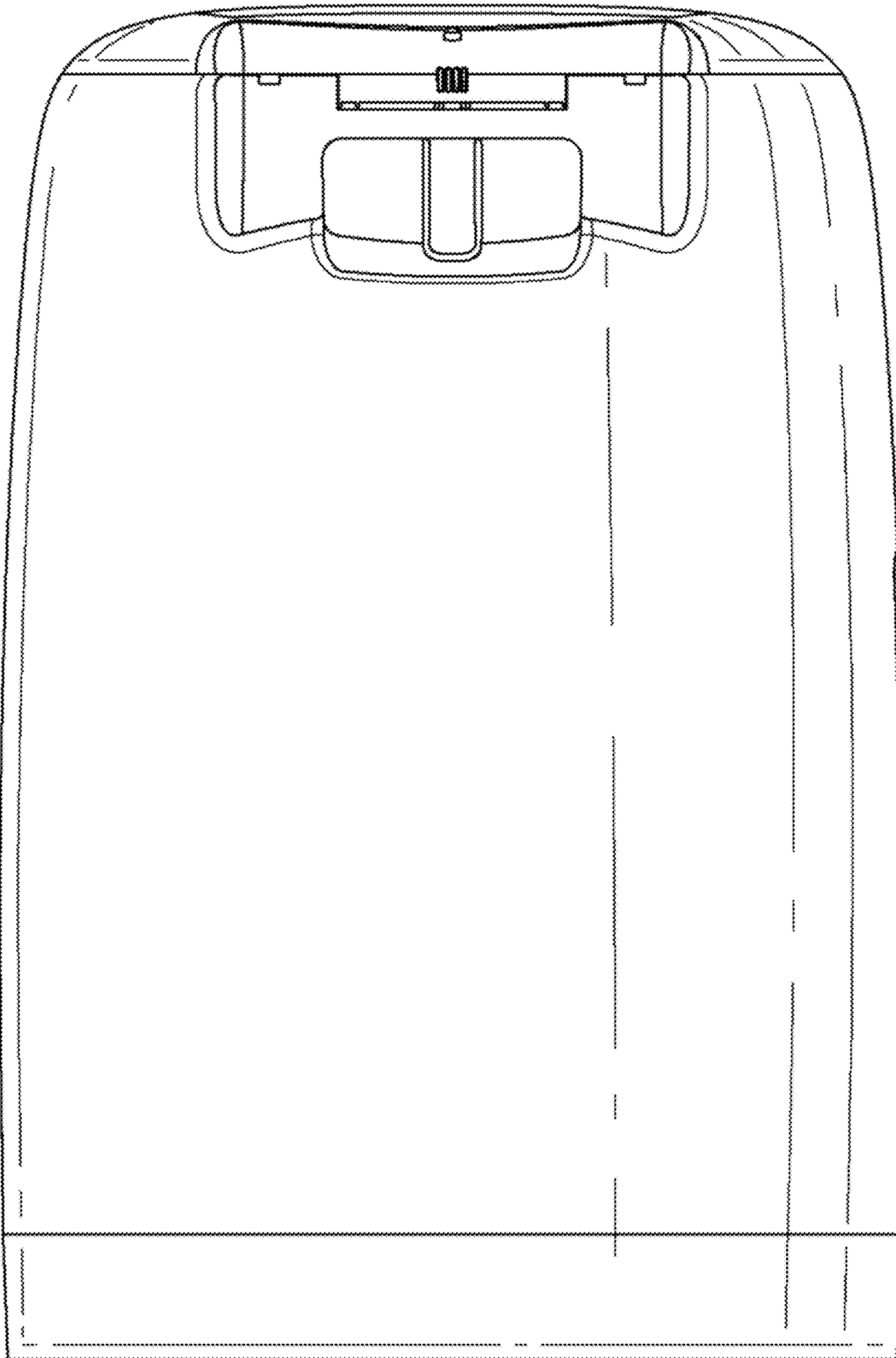

1.2

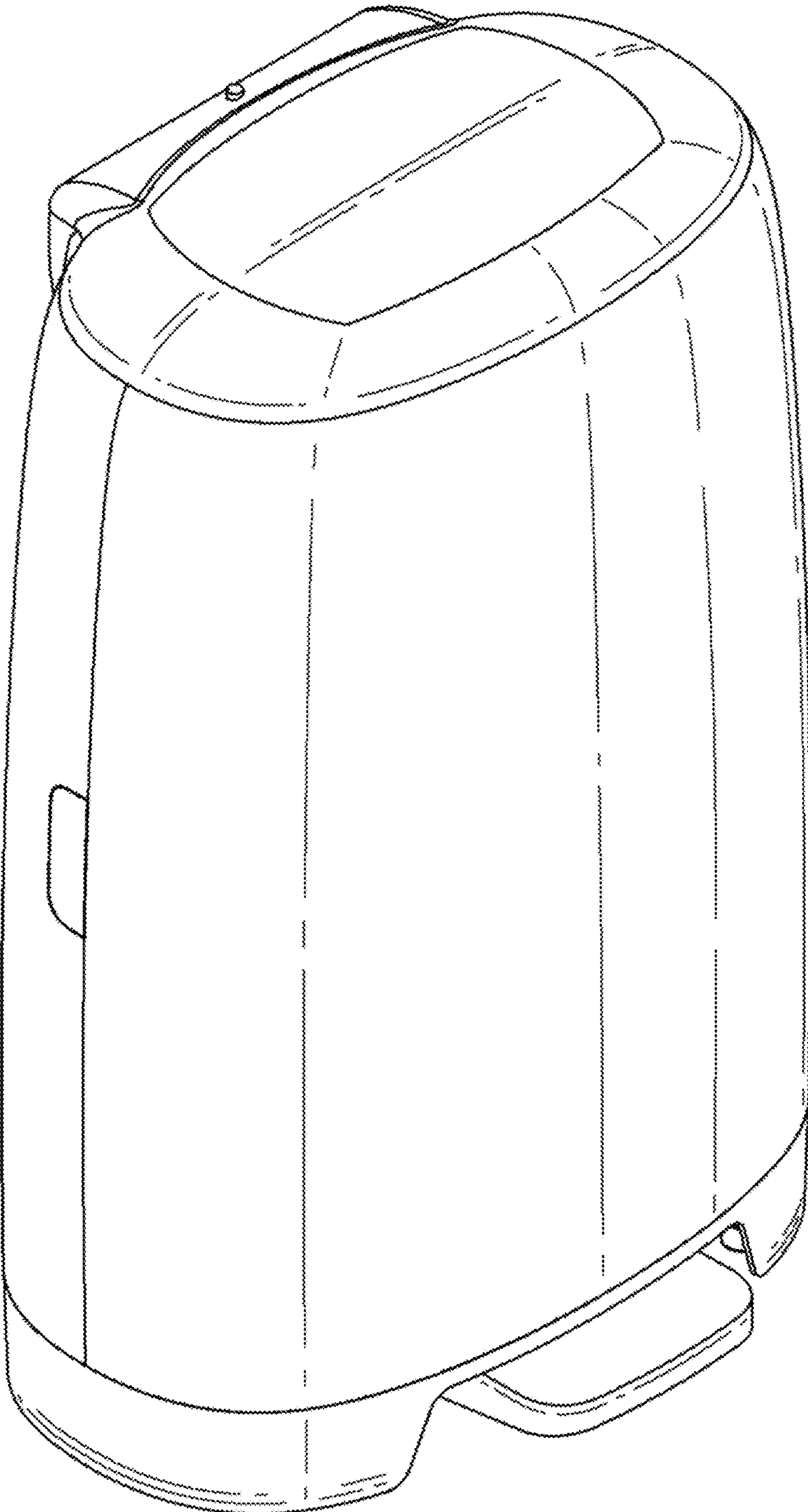

1.3

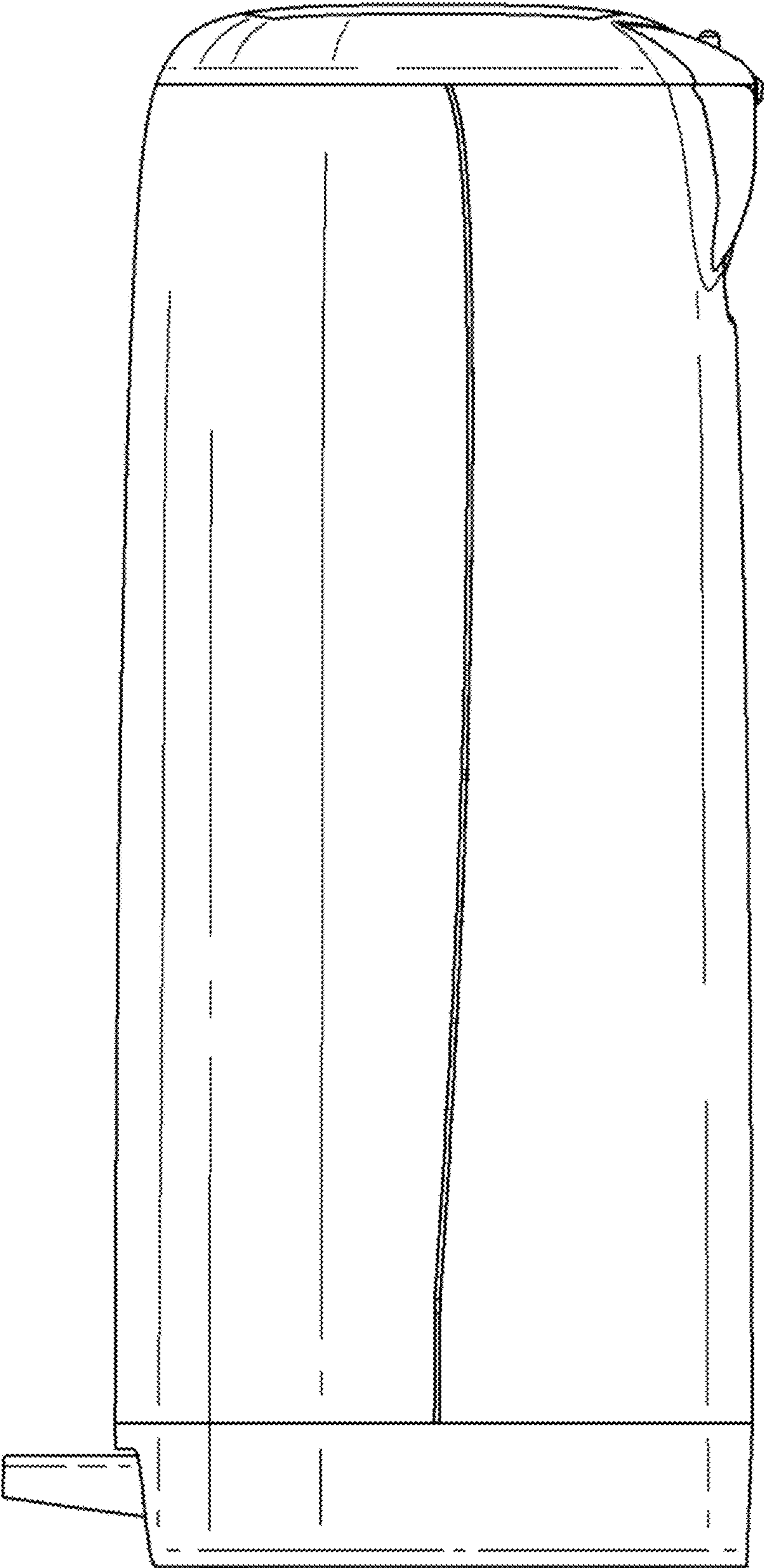

1.4

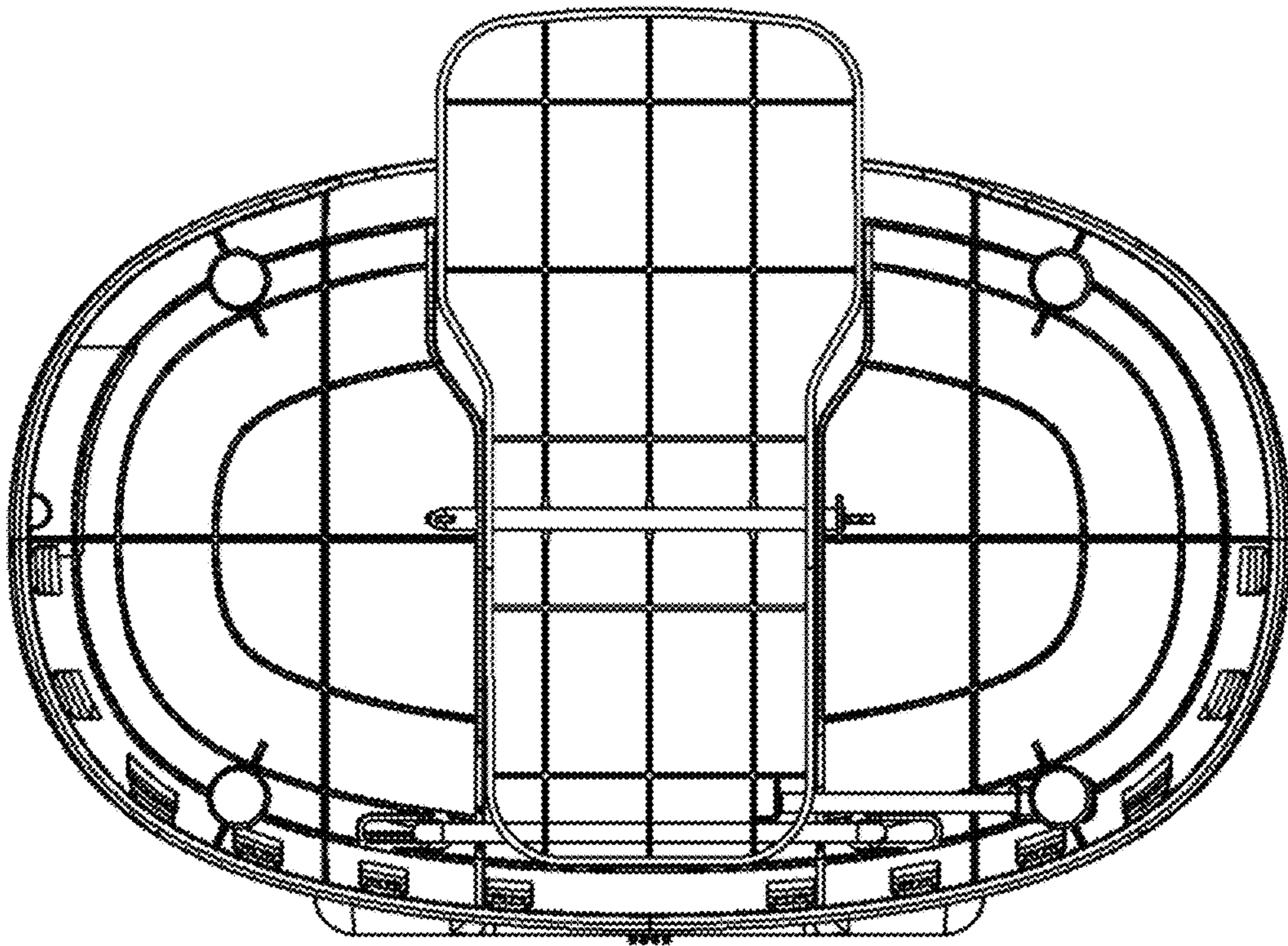

1.5

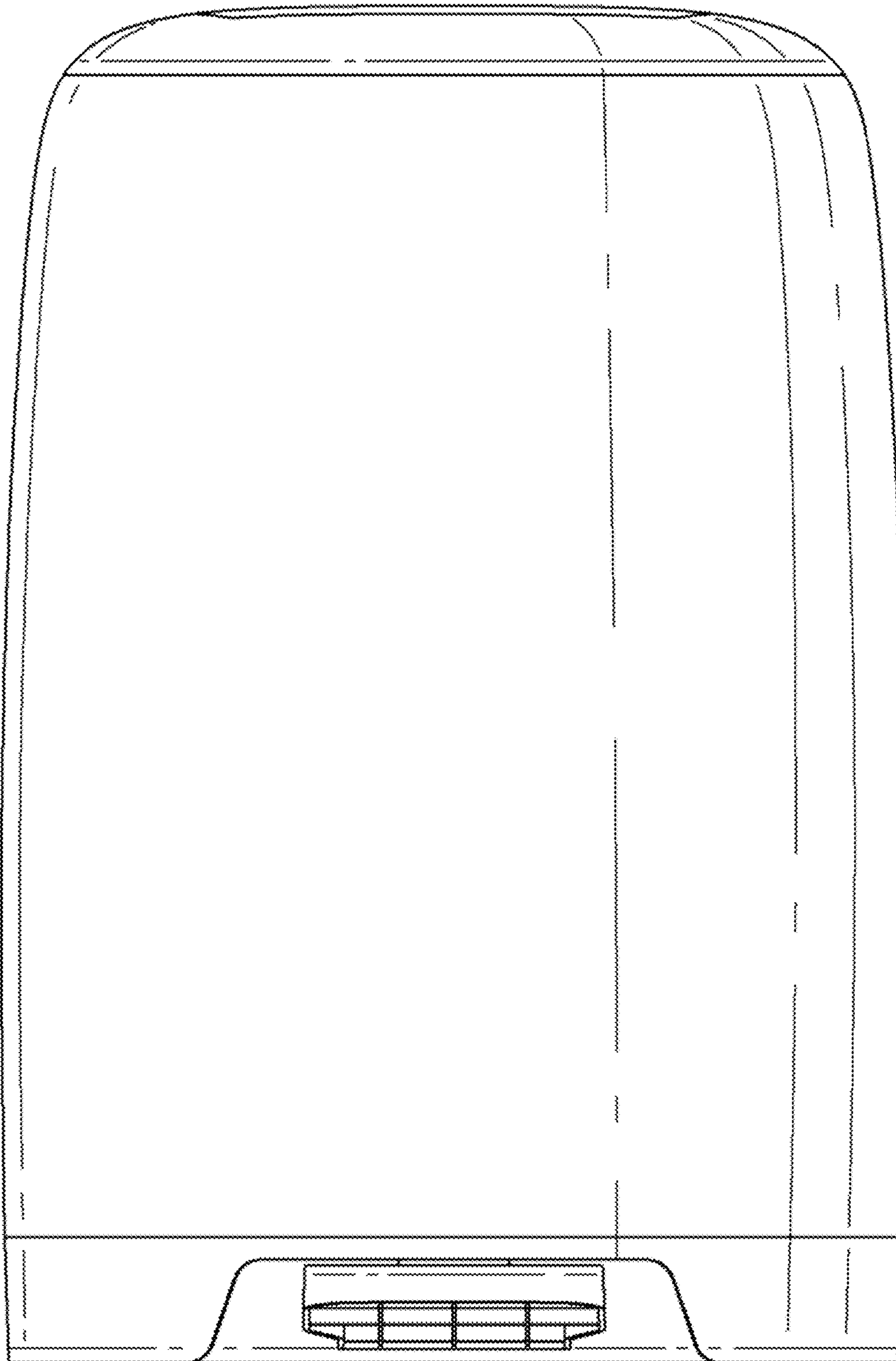

1.6

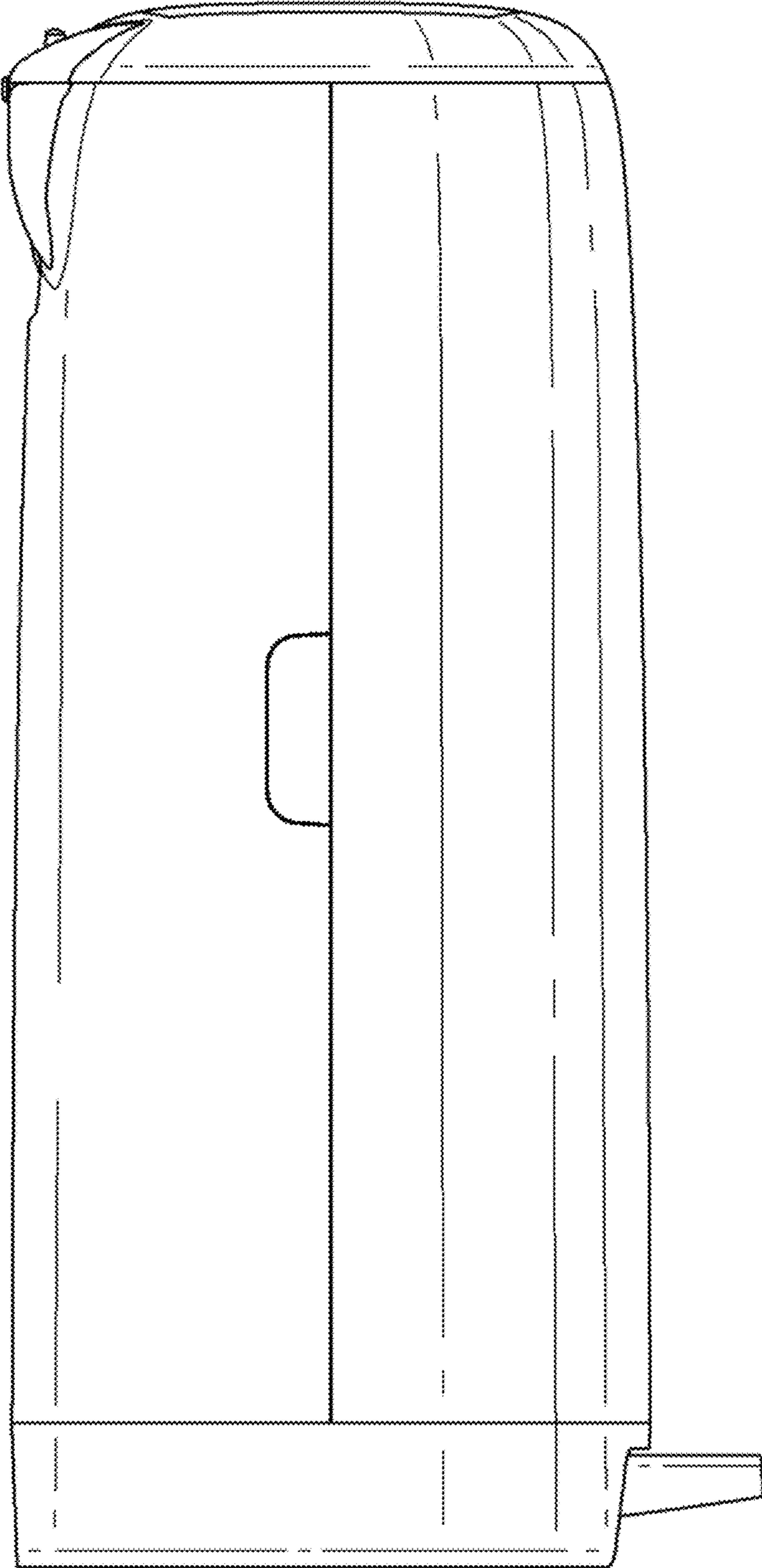

1.7

