



US00D822902S

(12) **United States Design Patent**
Shin

(10) **Patent No.:** **US D822,902 S**
(45) **Date of Patent:** **** Jul. 10, 2018**

(54) **RAZOR HANDLE**
(71) Applicant: **Dorco Co., Ltd.**, Seoul (KR)
(72) Inventor: **Seungmi Shin**, Seoul (KR)
(73) Assignee: **Dorco Co., Ltd.**, Seoul (KR)
(**) Term: **15 Years**
(21) Appl. No.: **29/595,590**

D619,763 S * 7/2010 Coresh D28/48
D628,345 S * 11/2010 Webb D28/48
D651,345 S * 12/2011 Micinilio D28/48
D675,048 S * 1/2013 Coresh D6/524
D694,471 S * 11/2013 Floyd D28/48
D698,999 S * 2/2014 Otsuka D28/47
D731,120 S * 6/2015 Otsuka D28/48
D773,734 S * 12/2016 Li D28/48
9,616,584 B2 * 4/2017 Coresh B26B 21/521
2015/0266192 A1 * 9/2015 Coresh B26B 21/521
30/526

(22) Filed: **Feb. 28, 2017**
(30) **Foreign Application Priority Data**

Aug. 29, 2016 (KR) 30-2016-0042080

(51) **LOC (11) Cl.** **28-03**
(52) **U.S. Cl.**
USPC **D28/48**
(58) **Field of Classification Search**
USPC D28/46-48
CPC B26B 21/08-21/32; B26B 21/02-21/06;
B26B 21/34-21/38; B26B 21/446; B26B
21/4068-21/4075; B26B 21/405-21/4062;
B26B 21/52-21/528
See application file for complete search history.

(56) **References Cited**
U.S. PATENT DOCUMENTS

D285,341 S * 8/1986 Audette D24/147
6,792,682 B2 * 9/2004 Follo B26B 21/222
30/50

* cited by examiner

Primary Examiner — Jennifer Rivard
(74) *Attorney, Agent, or Firm* — Perkins Coie LLP

(57) **CLAIM**

The ornamental design for a razor handle, as shown and described.

DESCRIPTION

FIG. 1 is a perspective view of a razor handle design;
FIG. 2 is a first side view of the razor handle design;
FIG. 3 is a second side view of the razor handle design;
FIG. 4 is a front view of the razor handle design;
FIG. 5 is a rear view of the razor handle design;
FIG. 6 is a top plan view of the razor handle design; and,
FIG. 7 is a bottom plan view of the razor handle design.
The ornamental design of a razor handle is shown in FIGS. 1 through 7.

1 Claim, 4 Drawing Sheets

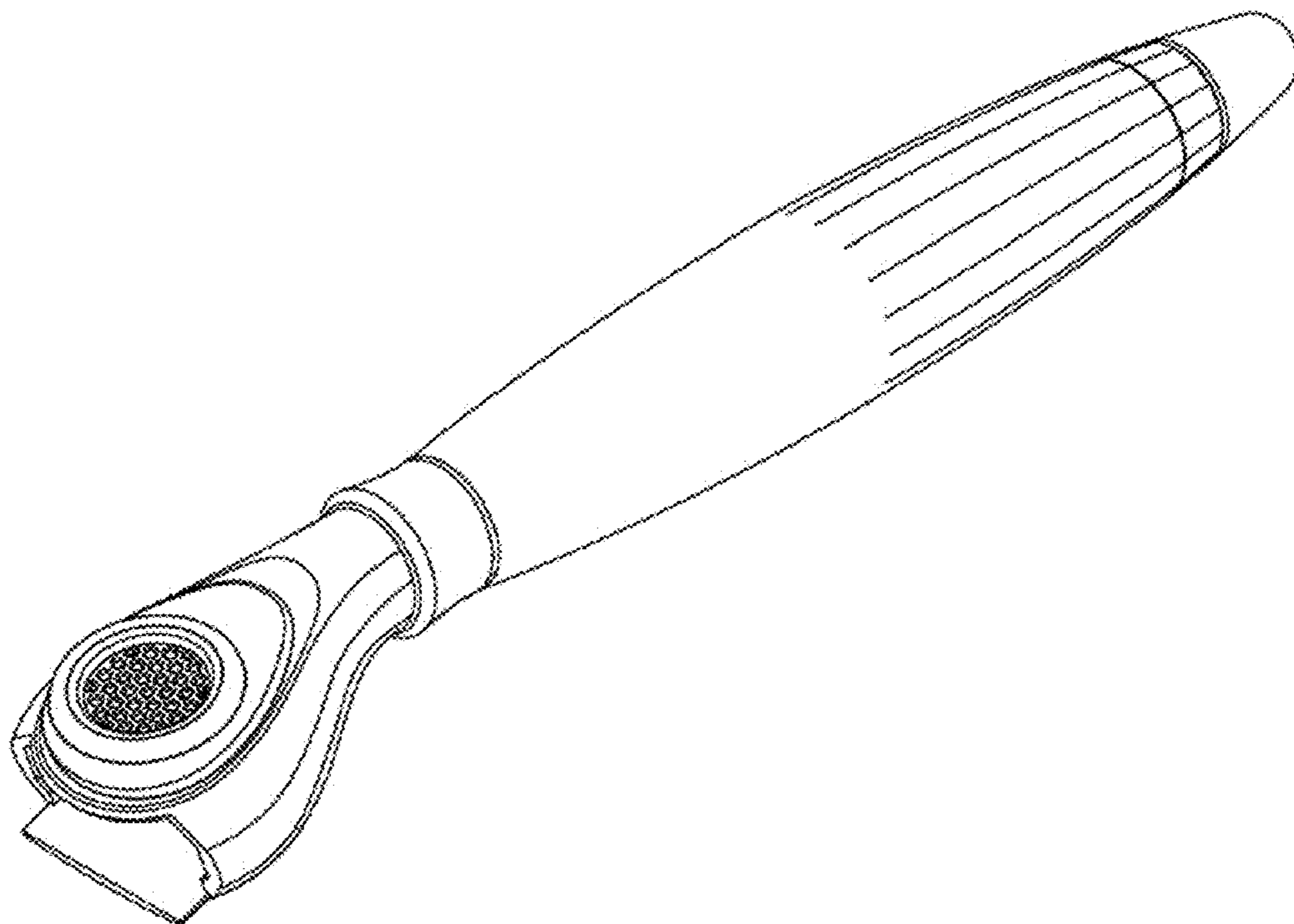

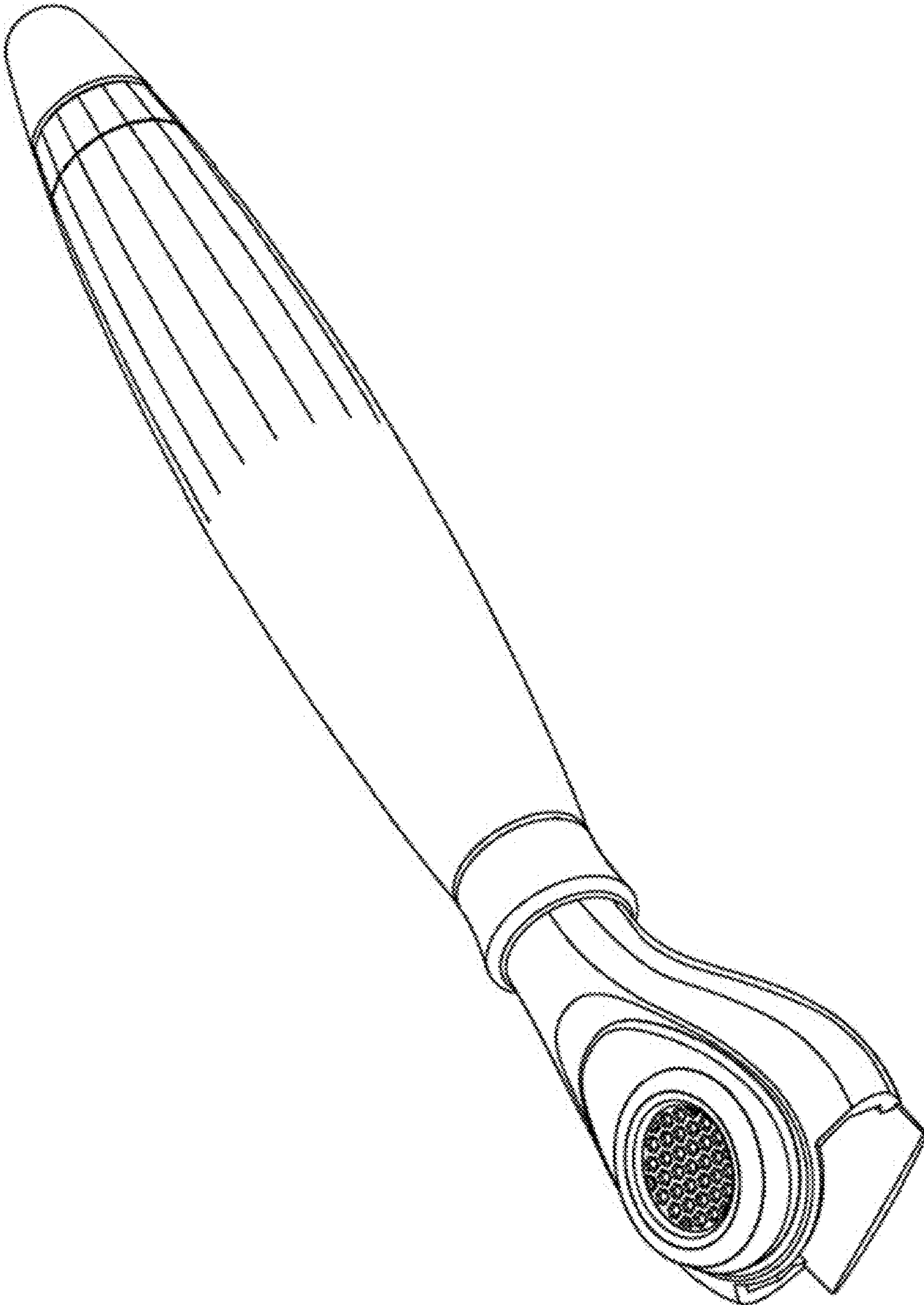

FIG. 1

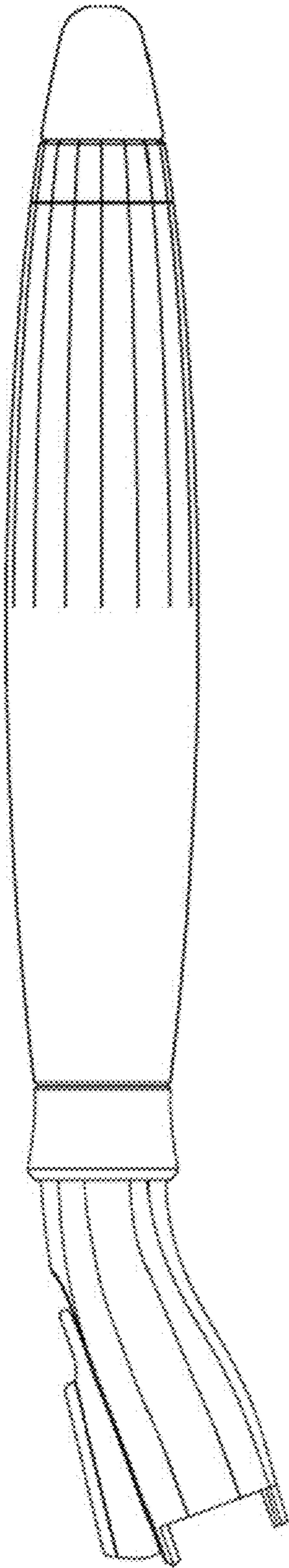

FIG. 2

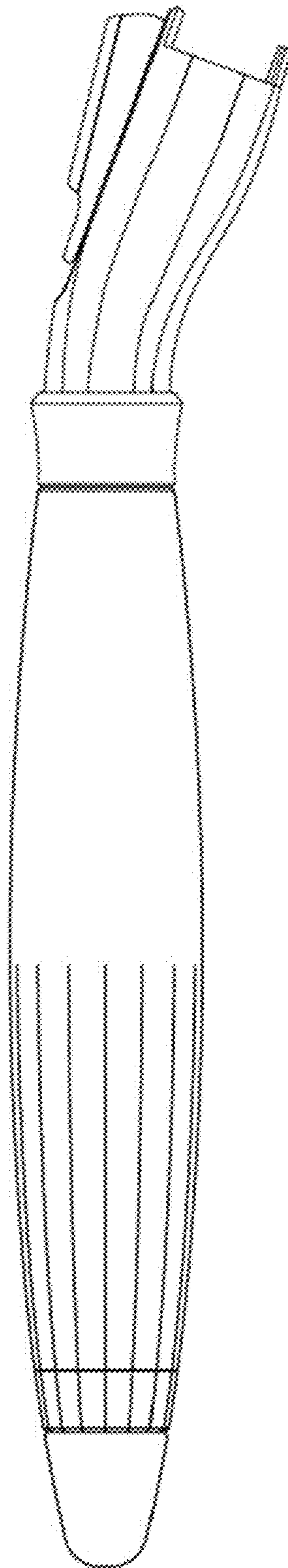

FIG. 3

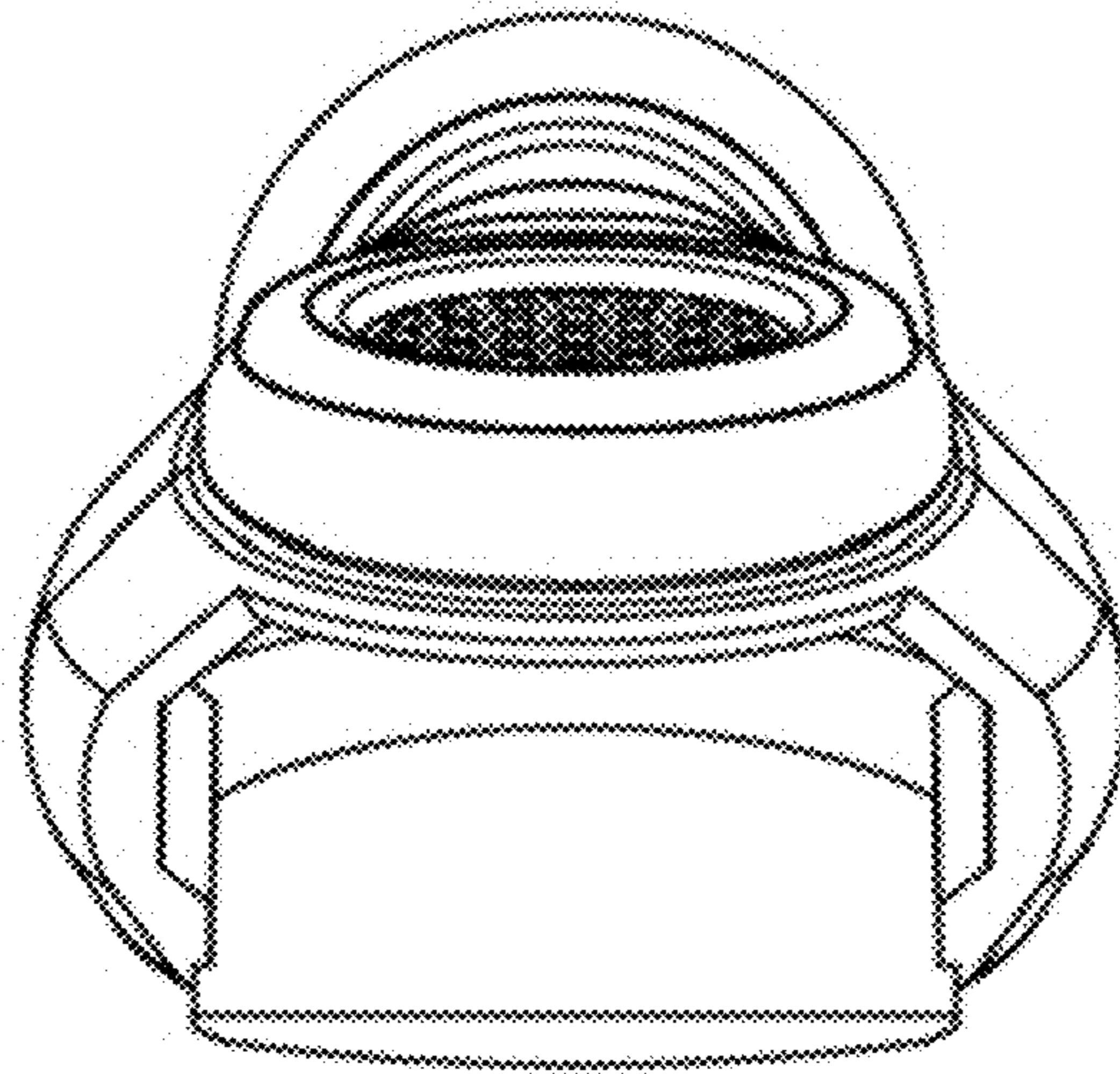

FIG. 4

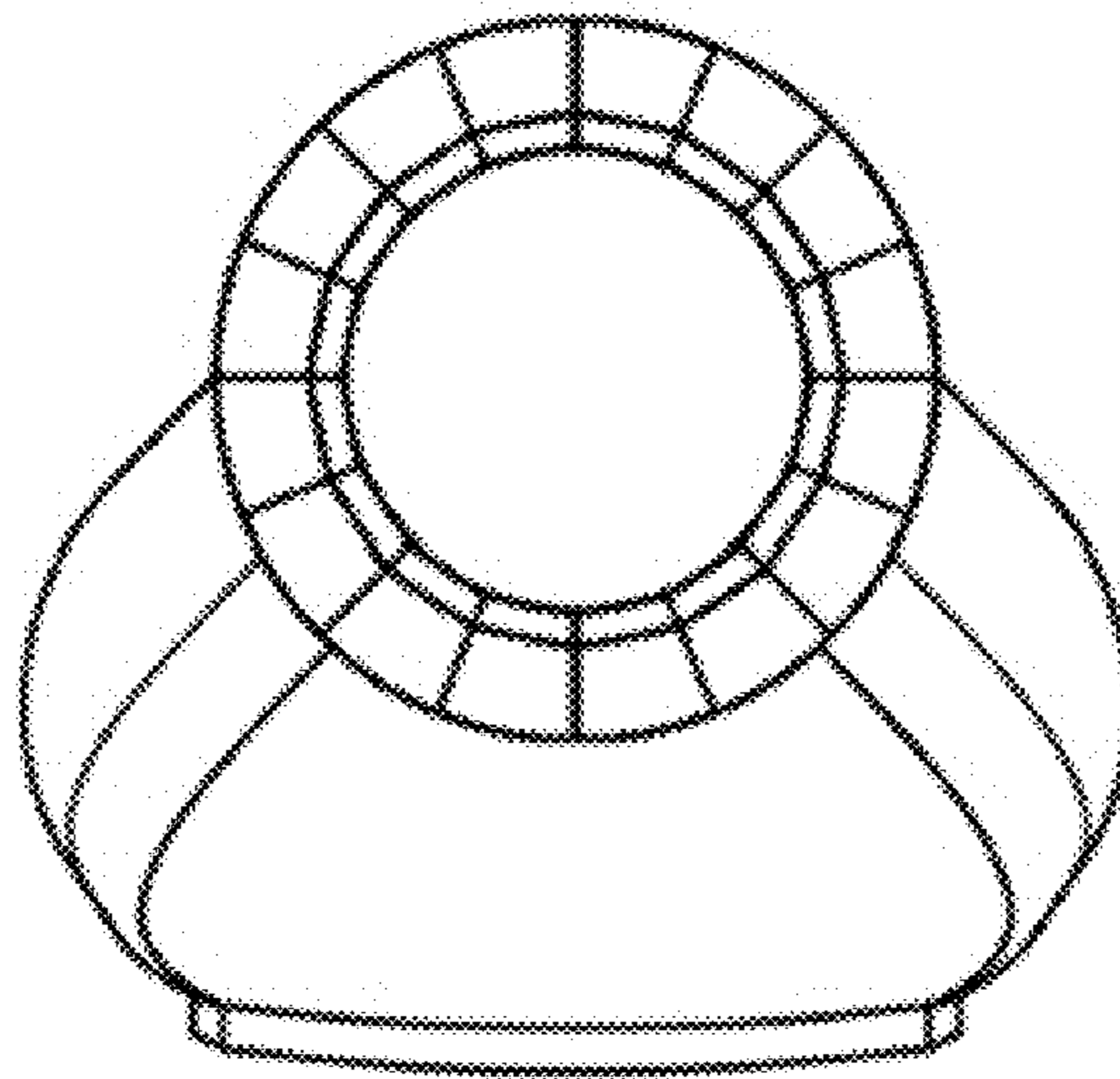

FIG. 5

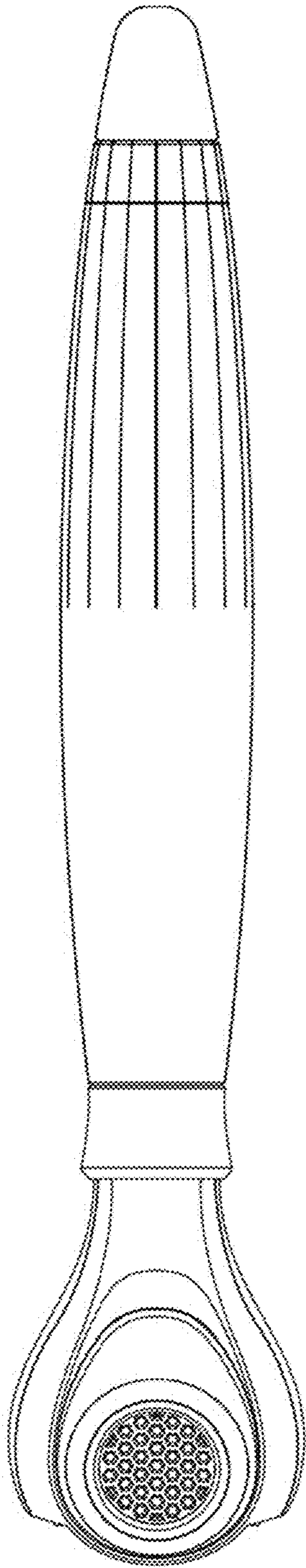

FIG. 6

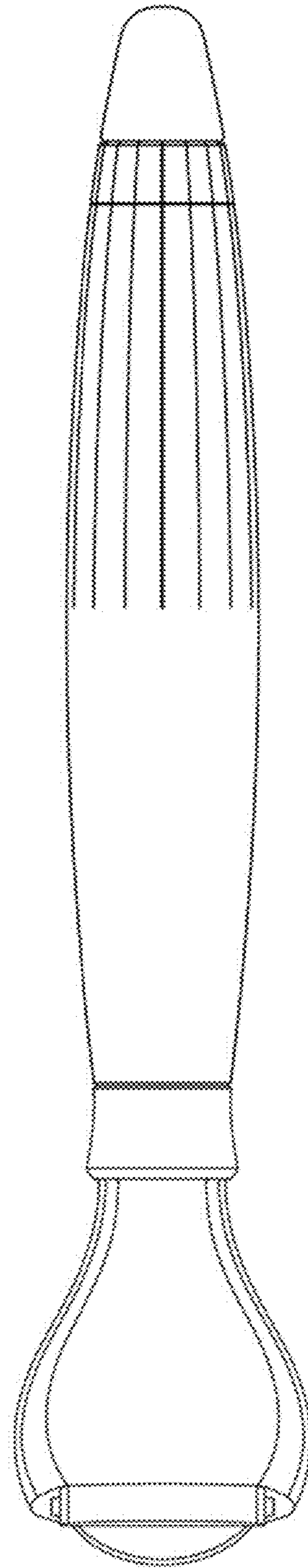

FIG. 7