



US00D822845S

(12) **United States Design Patent**
Shimobayashi et al.

(10) **Patent No.:** **US D822,845 S**
(45) **Date of Patent:** **** Jul. 10, 2018**

(54) **MEDICAL CLEANING AND DISINFECTION APPARATUS**

D760,915 S * 7/2016 Kagawa D24/217
D784,549 S * 4/2017 Brooks D24/216
9,788,711 B2 * 10/2017 Ogawa A61B 1/123
2008/0115814 A1 * 5/2008 Hasegawa A61B 1/123
134/56 R

(71) Applicant: **OLYMPUS CORPORATION**, Tokyo (JP)

(Continued)

(72) Inventors: **Koji Shimobayashi**, Tokyo (JP);
Chikayoshi Meguro, Tokyo (JP);
Hiromasa Akahori, Tokyo (JP)

OTHER PUBLICATIONS

(73) Assignee: **OLYMPUS CORPORATION**, Tokyo (JP)

2014 Endoscope Product Spotlights, posted at hponline.com, Nov. 2014 issue, [online], [site visited Nov. 14, 2017]. Available from Internet: URL: <https://www.hponline.com/inside/2014-11/1411-EndoSpots.html>.*

(**) Term: **15 Years**

(Continued)

(21) Appl. No.: **29/579,008**

Primary Examiner — Anhdao Doan

(22) Filed: **Sep. 27, 2016**

Assistant Examiner — Mary Malley

(30) **Foreign Application Priority Data**

(74) *Attorney, Agent, or Firm* — Scully, Scott, Murphy & Presser, P.C.

Mar. 28, 2016 (JP) 2016-006697

(51) **LOC (11) Cl.** **24-01**

(57) **CLAIM**

(52) **U.S. Cl.**
USPC **D24/217**

The ornamental design for a medical cleaning and disinfection apparatus, as shown and described.

(58) **Field of Classification Search**
USPC D24/216–218, 227–232; D32/1, 25
CPC A61L 2/26; A61L 2/24; A61L 2/17; A61L 2/18; A61L 2/025; A61L 2202/122; A61L 2202/10; A61L 2202/11; A61L 2202/14; A61L 2202/23; A61L 2202/24; A61L 2202/182; A61B 1/123; A61B 2090/701
See application file for complete search history.

DESCRIPTION

(56) **References Cited**

U.S. PATENT DOCUMENTS

D328,352 S * 7/1992 Futatsuka D18/53
D546,473 S * 7/2007 Xu D24/217
D702,353 S * 4/2014 Fujimoto D24/164
D709,202 S * 7/2014 Lamoureux D24/185
D711,605 S * 8/2014 Jo D32/25

FIG. 1 is a perspective view of a medical cleaning and disinfection apparatus, showing our new design;
FIG. 2 is a front view thereof;
FIG. 3 is a rear view thereof;
FIG. 4 is a top view thereof;
FIG. 5 is a bottom view thereof;
FIG. 6 is a left side view thereof;
FIG. 7 is a right side view thereof; and,
FIG. 8 is an enlarged sectional view, taken along line 8-8 in FIG. 2 of the portion thereof indicated by line a-a in FIG. 7. The broken lines show portions of the medical cleaning and disinfection apparatus that form no part of the claimed design.

1 Claim, 7 Drawing Sheets

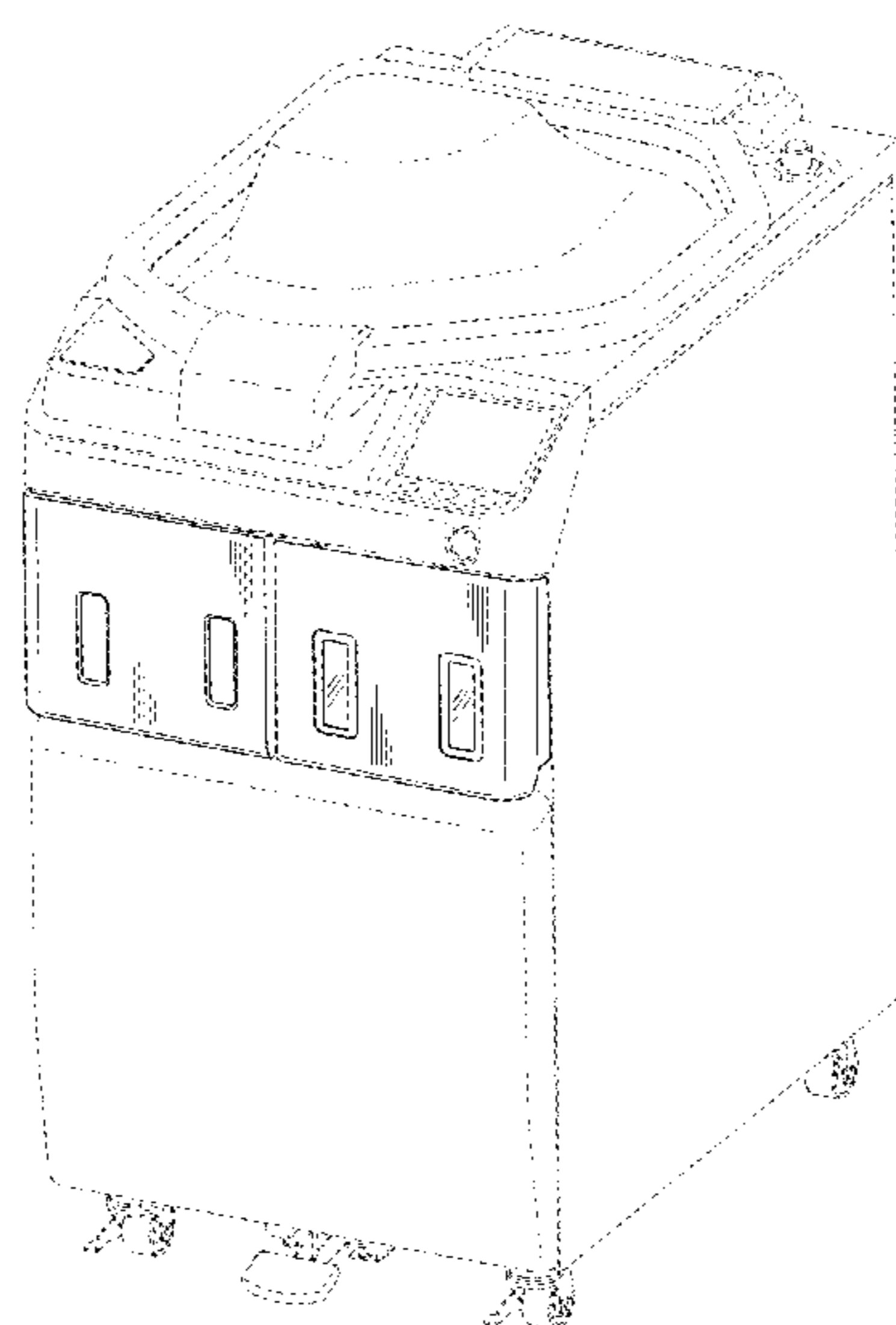

(56)

References Cited

U.S. PATENT DOCUMENTS

2014/0256025 A1* 9/2014 Esquenet C11D 3/38645
435/264
2014/0326282 A1* 11/2014 Kawachi A61B 19/34
134/99.1
2016/0302654 A1* 10/2016 Ogawa B08B 3/102

OTHER PUBLICATIONS

Olympus Endoscope Reprocessing With OER-Pro, posted at
youtube.com, posted on Feb. 12, 2016, [online], [site visited Nov.
15, 2017]. Available from Internet: URL:[https://www.youtube.com/
watch?v=WZqzlnekS2M](https://www.youtube.com/watch?v=WZqzlnekS2M).*

* cited by examiner

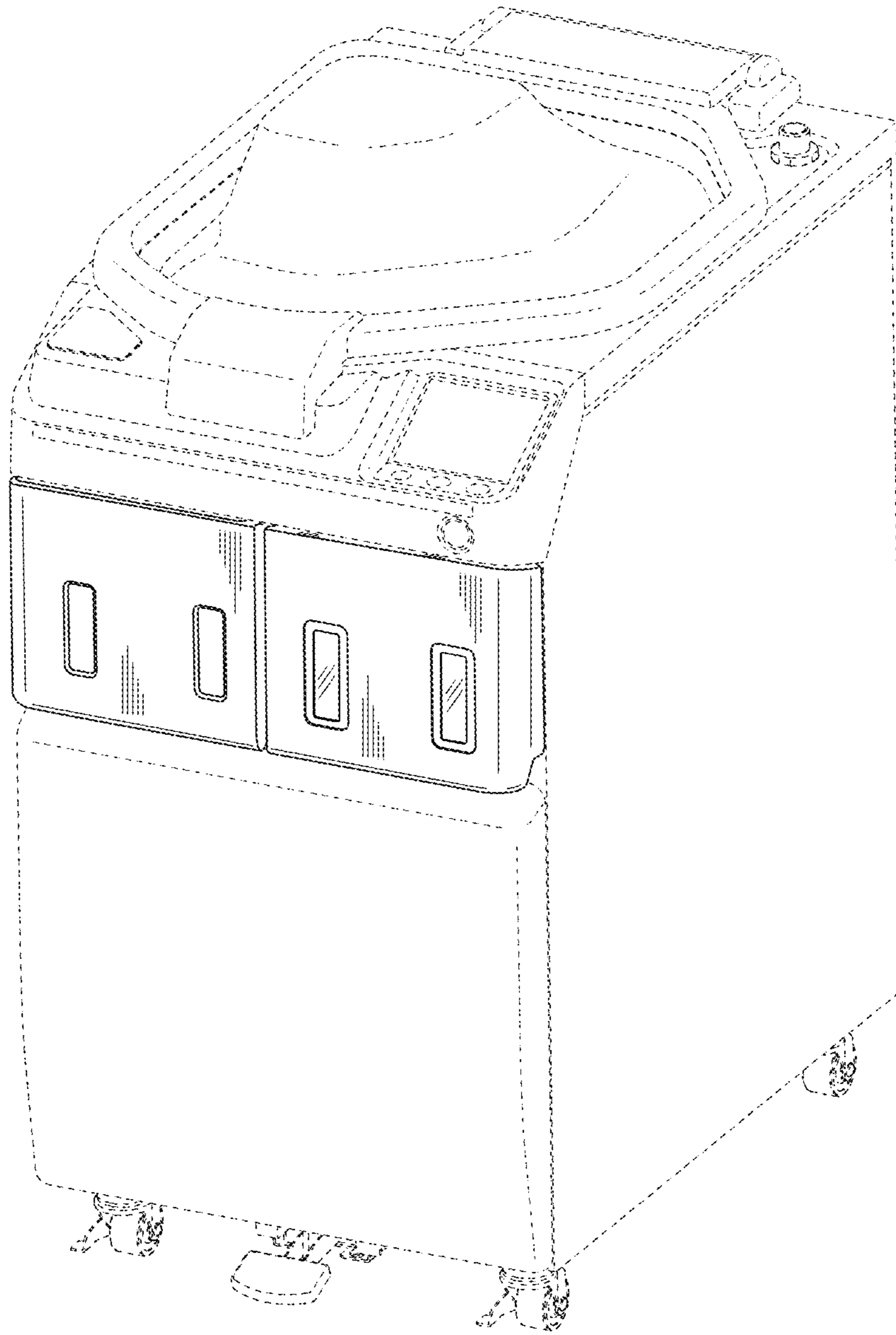

Fig. 1

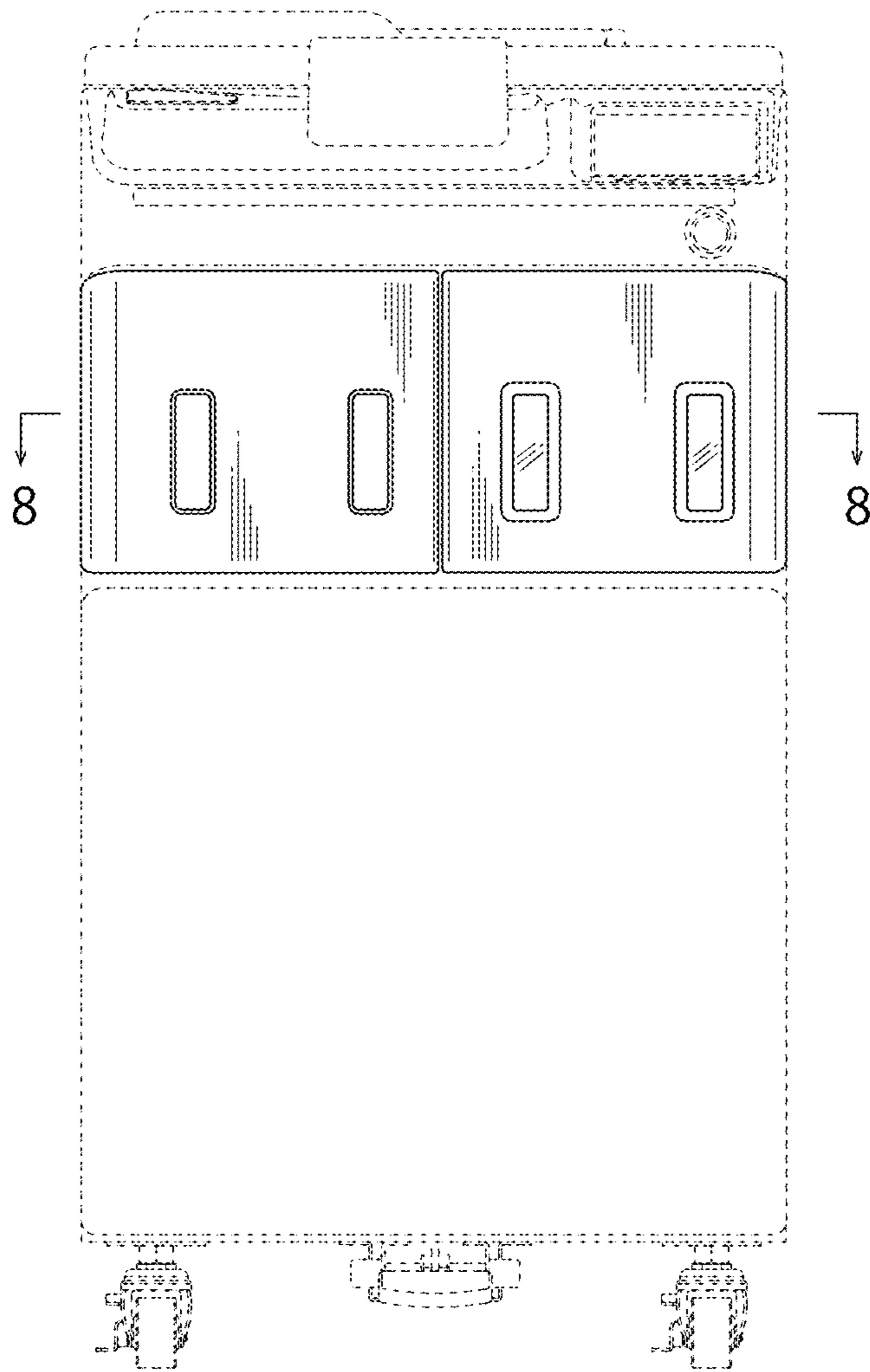

Fig. 2

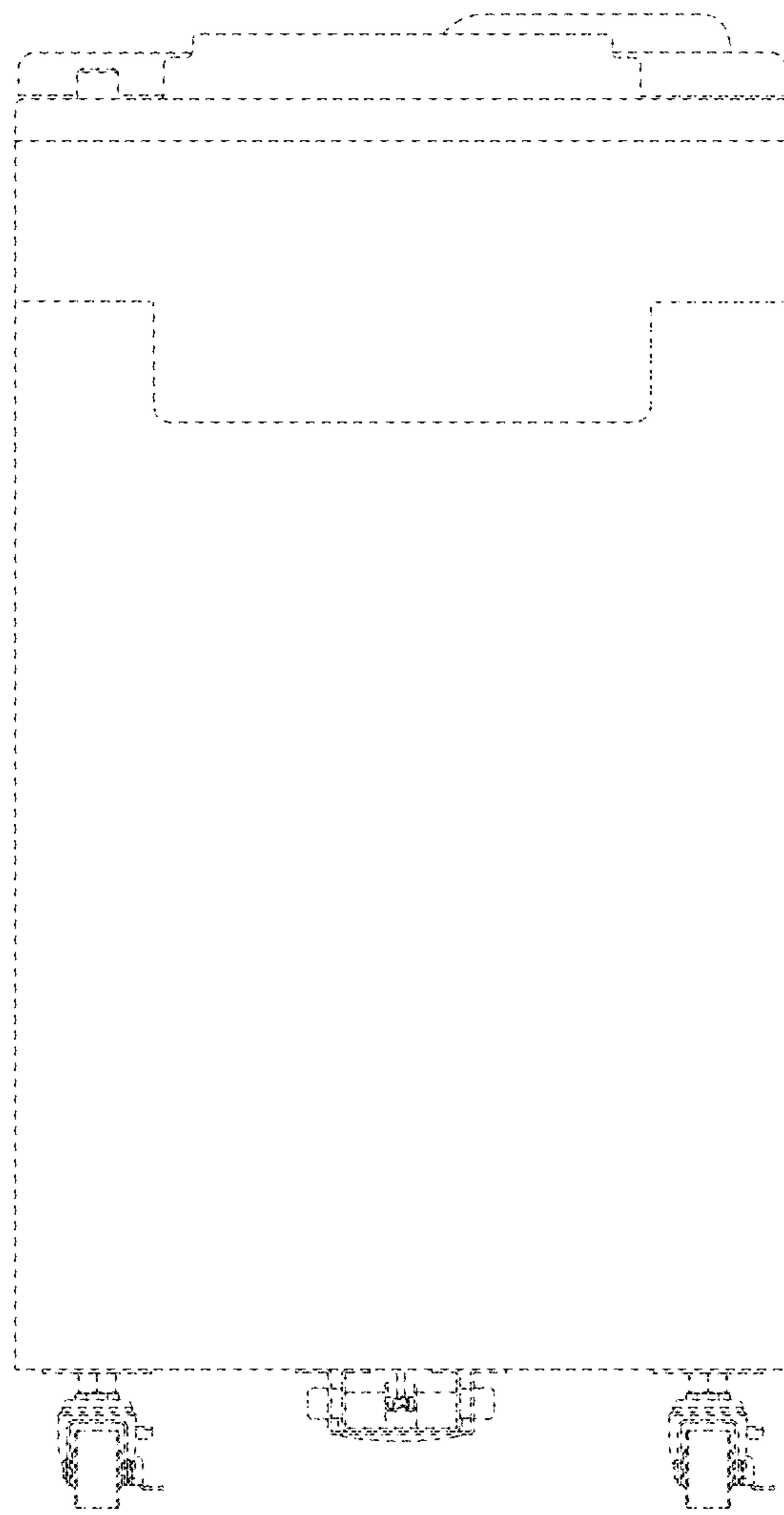

Fig.3

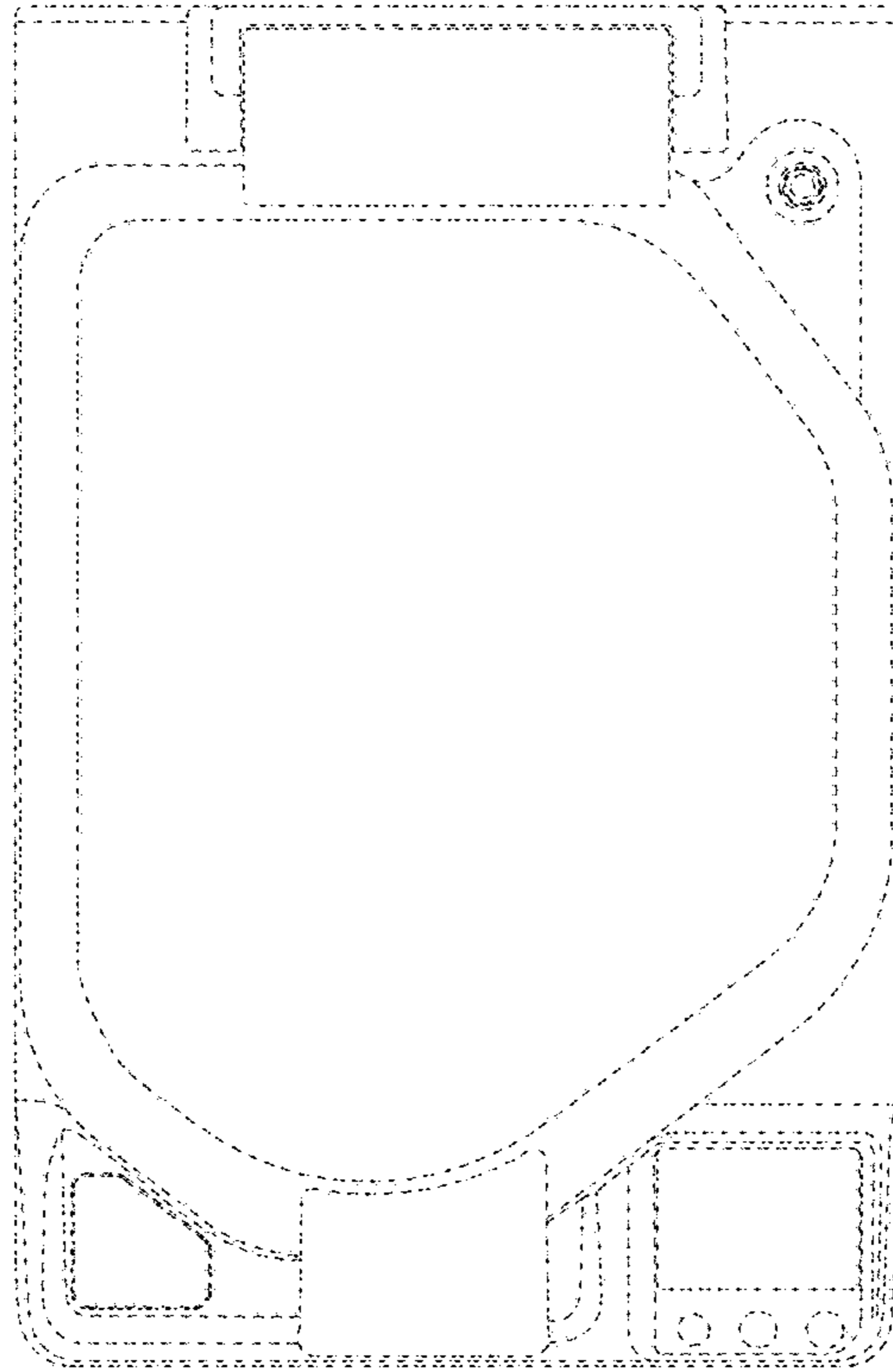

Fig. 4

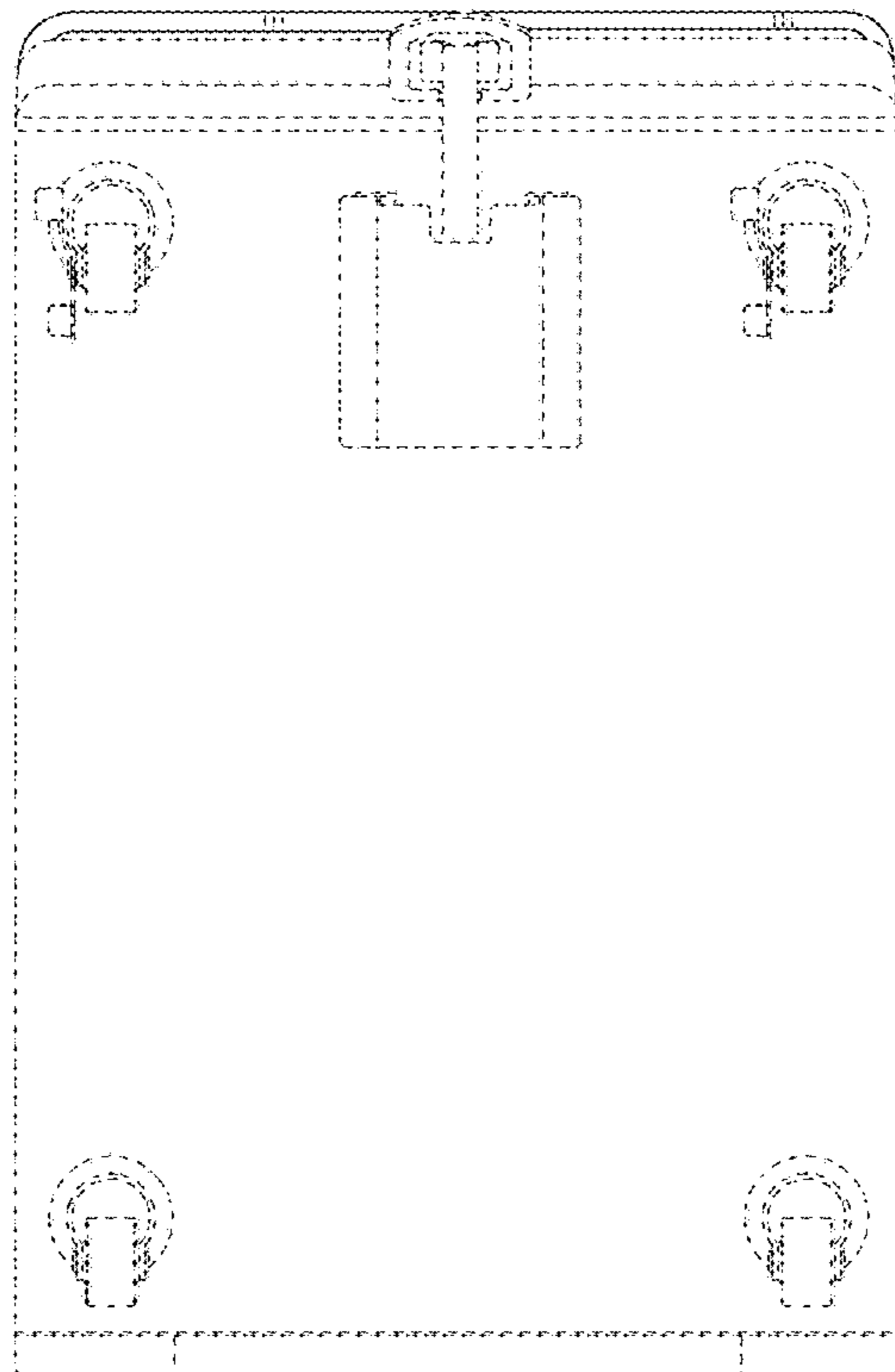

Fig. 5

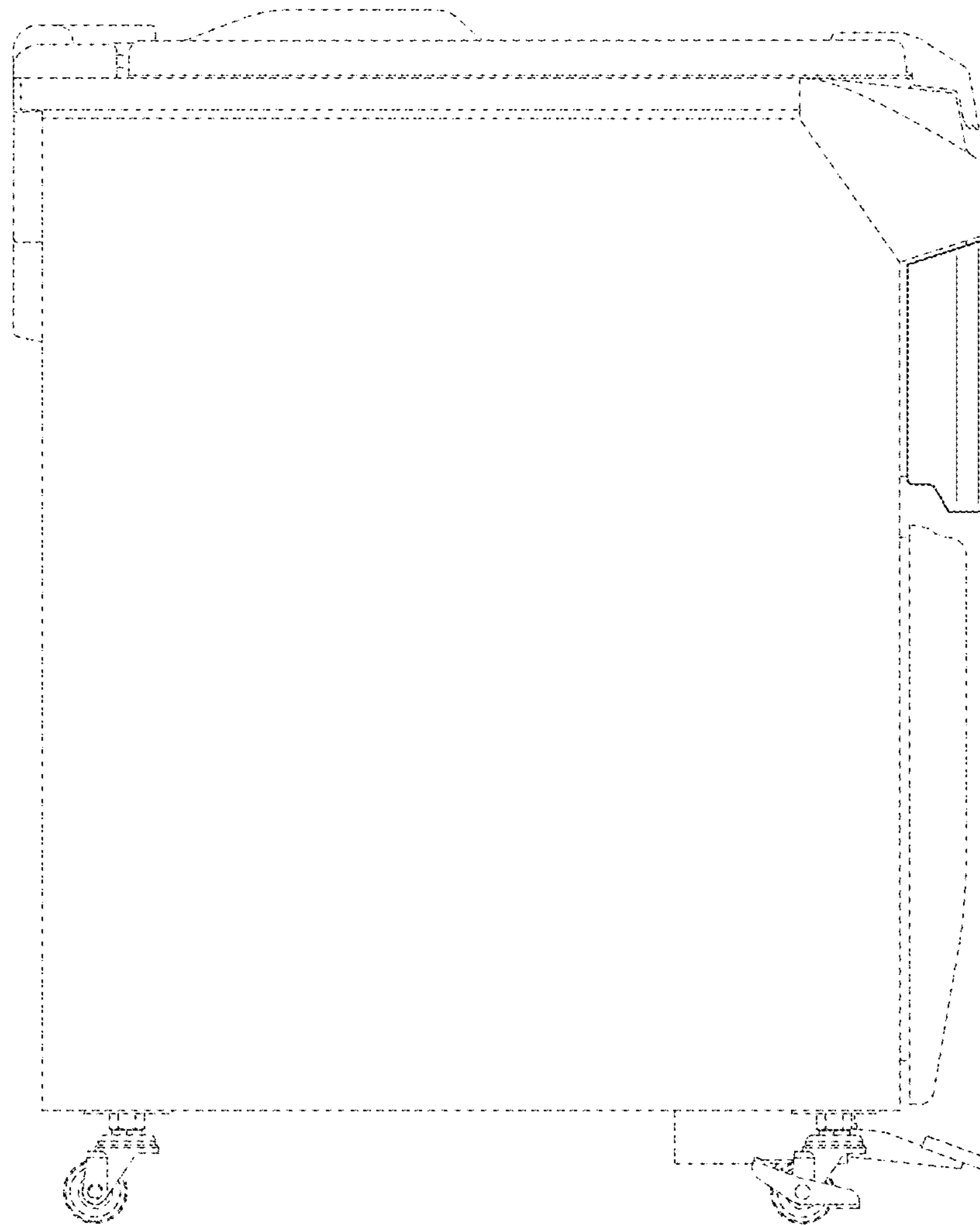

Fig.6

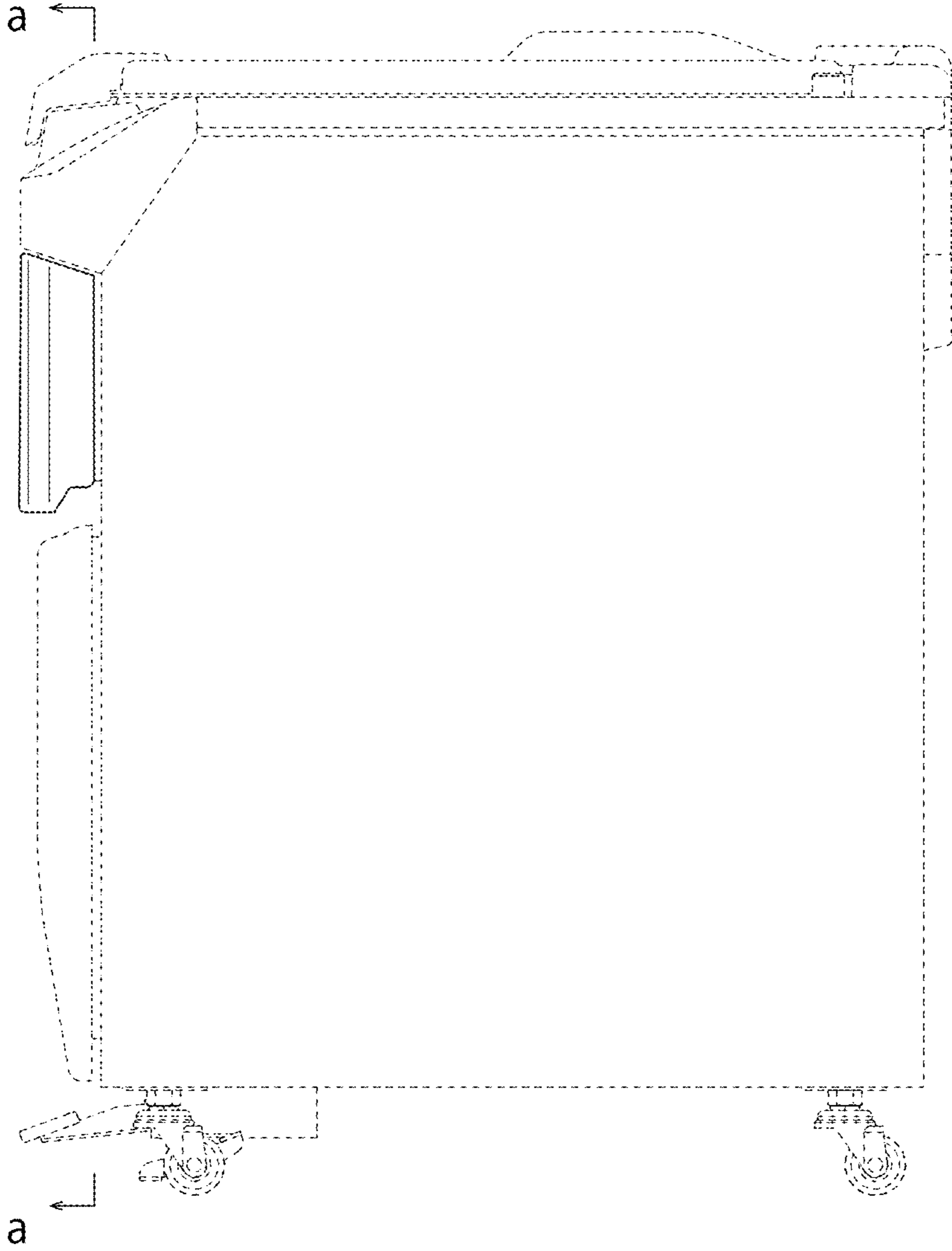

Fig. 7

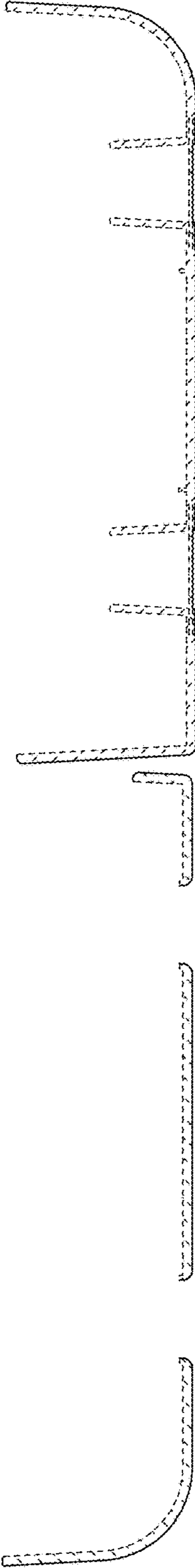

Fig. 8