



US00D822645S

(12) **United States Design Patent** (10) **Patent No.:** **US D822,645 S**
Loermann (45) **Date of Patent:** **** *Jul. 10, 2018**

(54) **HEADPHONE**
(71) Applicant: **BRAGI GmbH**, München (DE)
(72) Inventor: **Arne D Loermann**, München (DE)
(73) Assignee: **BRAGI GmbH**, München (DE)

4,617,429 A 10/1986 Bellafore
4,654,883 A 3/1987 Iwata
4,682,180 A 7/1987 Gans
4,791,673 A 12/1988 Schreiber
4,852,177 A 7/1989 Ambrose
4,865,044 A 9/1989 Wallace et al.
4,984,277 A 1/1991 Bisgaard et al.

(Continued)

(*) Notice: This patent is subject to a terminal disclaimer.

FOREIGN PATENT DOCUMENTS

(**) Term: **15 Years**

EP 1017252 A3 5/2006
GB 2074817 4/1981

(Continued)

(21) Appl. No.: **29/576,545**

(22) Filed: **Sep. 3, 2016**

(51) **LOC (11) Cl.** **14-01**

(52) **U.S. Cl.**
USPC **D14/223**

(58) **Field of Classification Search**
USPC D24/173-175; D14/205, 223-226, 249
CPC H04R 2225/025; H04R 25/00; H04R
1/1016; H04R 1/105; H04R 1/1083;
H04R 25/02; H04R 25/60; H04R 25/67;
H04R 25/602; H04R 25/604; H04R
25/608

See application file for complete search history.

Announcing the \$3,333,333 Stretch Goal (Feb. 24, 2014).

(Continued)

Primary Examiner — Garth Rademaker
Assistant Examiner — Samantha Q. Lawrence
(74) *Attorney, Agent, or Firm* — Goodhue, Coleman & Owens, P.C.

OTHER PUBLICATIONS

(57) **CLAIM**
The ornamental design for a headphone, as shown and described.

(56) **References Cited**

DESCRIPTION

U.S. PATENT DOCUMENTS

2,325,590 A 8/1943 Carlisle et al.
2,430,229 A 11/1947 Kelsey
3,047,089 A 7/1962 Zwislocki
D208,784 S 10/1967 Sanzone
3,586,794 A 6/1971 Michaelis
3,934,100 A 1/1976 Harada
3,983,336 A 9/1976 Malek et al.
4,069,400 A 1/1978 Johanson et al.
4,150,262 A 4/1979 Ono
4,334,315 A 6/1982 Ono et al.
D266,271 S 9/1982 Johanson et al.
4,375,016 A 2/1983 Harada
4,588,867 A 5/1986 Konomi

FIG. 1 is a perspective view of a headphone in accordance with the present invention;
FIG. 2 is a top view thereof;
FIG. 3 is a bottom view thereof;
FIG. 4 is a left side view thereof;
FIG. 5 is a right side view thereof;
FIG. 6 is a rear view thereof; and,
FIG. 7 is a front view thereof.
The broken lines in the Figures show portions of the headphone and environment which form no part of the claimed design.

1 Claim, 2 Drawing Sheets

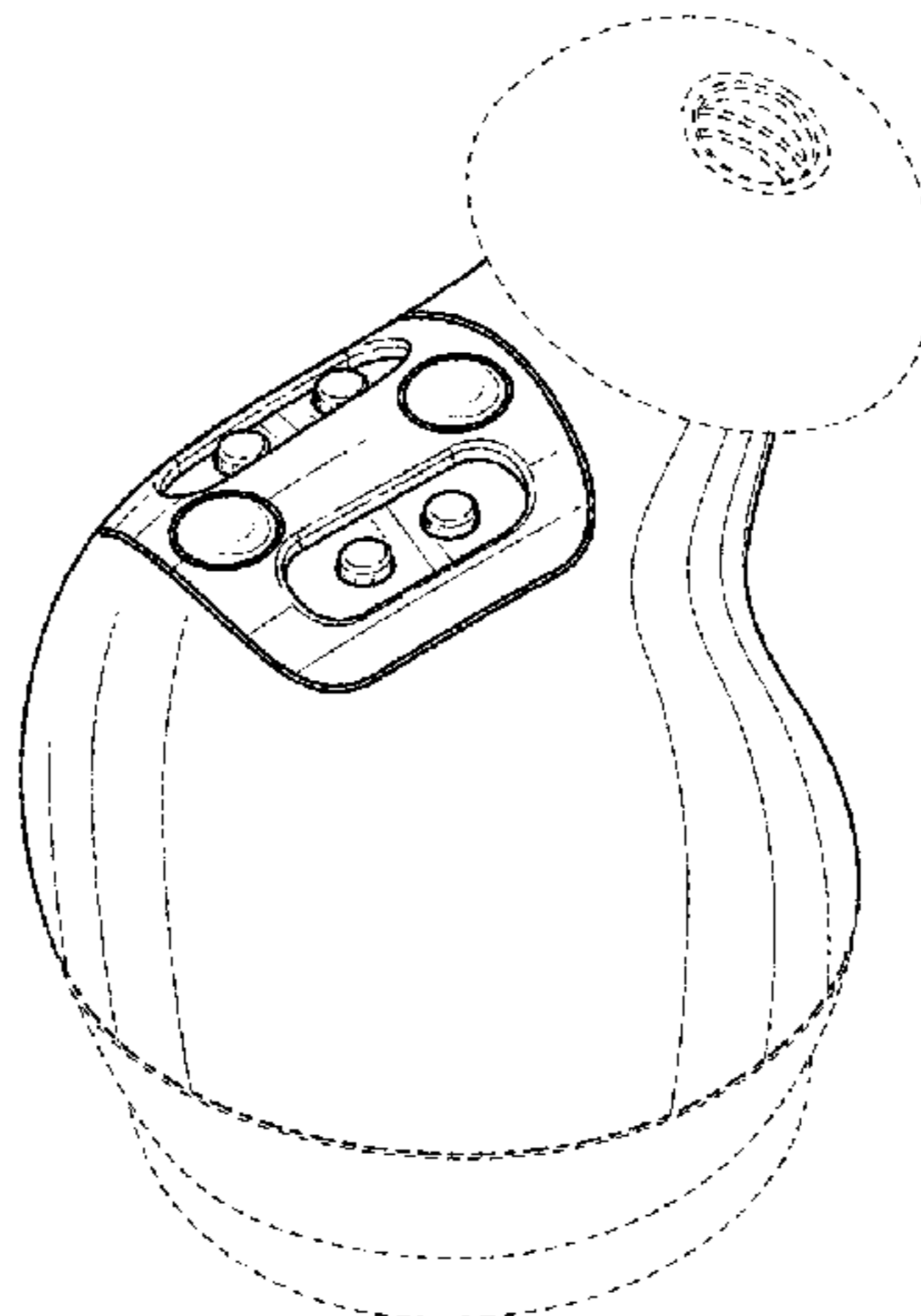

(56)

References Cited

U.S. PATENT DOCUMENTS

5,008,943 A 4/1991 Arndt et al.
 5,185,802 A 2/1993 Stanton
 5,191,602 A 3/1993 Regen et al.
 5,201,007 A 4/1993 Ward et al.
 5,201,008 A 4/1993 Arndt et al.
 D340,286 S 10/1993 Seo
 5,280,524 A 1/1994 Norris
 5,295,193 A 3/1994 Ono
 5,298,692 A 3/1994 Ikeda et al.
 5,343,532 A 8/1994 Shugart
 5,347,584 A 9/1994 Narisawa
 5,363,444 A 11/1994 Norris
 D367,113 S 2/1996 Weeks
 5,497,339 A 3/1996 Bernard
 5,606,621 A 2/1997 Reiter et al.
 5,613,222 A 3/1997 Guenther
 5,654,530 A 8/1997 Sauer et al.
 5,692,059 A 11/1997 Kruger
 5,721,783 A 2/1998 Anderson
 5,748,743 A 5/1998 Weeks
 5,749,072 A 5/1998 Mazurkiewicz et al.
 5,771,438 A 6/1998 Palermo et al.
 D397,796 S 9/1998 Yabe et al.
 5,802,167 A 9/1998 Hong
 D410,008 S 5/1999 Almqvist
 5,929,774 A 7/1999 Charlton
 5,933,506 A 8/1999 Aoki et al.
 5,949,896 A 9/1999 Nageno et al.
 5,987,146 A 11/1999 Pluinage et al.
 6,021,207 A 2/2000 Puthuff et al.
 6,054,989 A 4/2000 Robertson et al.
 6,081,724 A 6/2000 Wilson
 6,094,492 A 7/2000 Boesen
 6,111,569 A 8/2000 Brusky et al.
 6,112,103 A 8/2000 Puthuff
 6,157,727 A 12/2000 Rueda
 6,167,039 A 12/2000 Karlsson et al.
 6,181,801 B1 1/2001 Puthuff et al.
 6,208,372 B1 3/2001 Barraclough
 6,275,789 B1 8/2001 Moser et al.
 6,339,754 B1 1/2002 Flanagan et al.
 D455,835 S 4/2002 Anderson et al.
 6,408,081 B1 6/2002 Boesen
 D464,039 S 10/2002 Boesen
 6,470,893 B1 10/2002 Boesen
 D468,299 S 1/2003 Boesen
 D468,300 S 1/2003 Boesen
 6,542,721 B2 4/2003 Boesen
 6,560,468 B1 5/2003 Boesen
 6,654,721 B2 11/2003 Handelman
 6,664,713 B2 12/2003 Boesen
 6,690,807 B1 2/2004 Meyer
 6,694,180 B1 2/2004 Boesen
 6,718,043 B1 4/2004 Boesen
 6,738,485 B1 5/2004 Boesen
 6,748,095 B1 6/2004 Goss
 6,754,358 B1 6/2004 Boesen et al.
 6,784,873 B1 8/2004 Boesen et al.
 6,823,195 B1 11/2004 Boesen
 6,852,084 B1 2/2005 Boesen
 6,879,698 B2 4/2005 Boesen
 6,892,082 B2 5/2005 Boesen
 6,920,229 B2 7/2005 Boesen
 6,952,483 B2 10/2005 Boesen et al.
 6,987,986 B2 1/2006 Boesen
 7,010,137 B1 3/2006 Leedom et al.
 7,113,611 B2 9/2006 Leedom et al.
 D532,520 S 11/2006 Kampmeier et al.
 7,136,282 B1 11/2006 Rebeske
 7,203,331 B2 4/2007 Boesen
 7,209,569 B2 4/2007 Boesen
 7,215,790 B2 5/2007 Boesen et al.
 D549,222 S 8/2007 Huang
 D554,756 S 11/2007 Sjursen et al.
 7,403,629 B1 7/2008 Aceti et al.

D579,006 S 10/2008 Kim et al.
 7,463,902 B2 12/2008 Boesen
 7,508,411 B2 3/2009 Boesen
 D601,134 S 9/2009 Elabidi et al.
 D611,606 S * 3/2010 Vaterlaus D24/174
 D636,492 S * 4/2011 Aquilina D24/174
 7,965,855 B1 6/2011 Ham
 7,983,628 B2 7/2011 Boesen
 D647,491 S 10/2011 Chen et al.
 8,140,357 B1 3/2012 Boesen
 D666,581 S 9/2012 Perez
 8,406,448 B2 3/2013 Lin
 D687,021 S 7/2013 Yuen
 D687,952 S * 8/2013 Dubs D24/174
 D698,761 S * 2/2014 Bao D14/223
 8,774,434 B2 7/2014 Zhao et al.
 8,831,266 B1 9/2014 Huang
 D720,075 S * 12/2014 Soeta D24/174
 D725,626 S * 3/2015 Kalhok D14/205
 D728,107 S * 4/2015 Torres Martin D24/174
 D733,103 S 6/2015 Jeong et al.
 D734,472 S * 7/2015 Meinertz D24/174
 D735,339 S * 7/2015 Meinertz D24/174
 D744,456 S * 12/2015 Pedersen D14/223
 D770,426 S * 11/2016 LaBerge D14/205
 D773,439 S * 12/2016 Walker D14/205
 D775,158 S 12/2016 Dong et al.
 D777,149 S * 1/2017 Bonahoom D14/223
 D777,710 S * 1/2017 Palmberg D14/223
 D788,079 S 5/2017 Son et al.
 2001/0005197 A1 6/2001 Mishra et al.
 2001/0027121 A1 10/2001 Boesen
 2001/0043707 A1 11/2001 Leedom
 2001/0056350 A1 12/2001 Calderone et al.
 2002/0002413 A1 1/2002 Tokue
 2002/0007510 A1 1/2002 Mann
 2002/0010590 A1 1/2002 Lee
 2002/0030637 A1 3/2002 Mann
 2002/0046035 A1 4/2002 Kitahara et al.
 2002/0057810 A1 5/2002 Boesen
 2002/0076073 A1 6/2002 Taenzer et al.
 2002/0118852 A1 8/2002 Boesen
 2003/0065504 A1 4/2003 Kraemer et al.
 2003/0100331 A1 5/2003 Dress et al.
 2003/0104806 A1 6/2003 Ruef et al.
 2003/0115068 A1 6/2003 Boesen
 2003/0125096 A1 7/2003 Boesen
 2003/0218064 A1 11/2003 Conner et al.
 2004/0070564 A1 4/2004 Dawson et al.
 2004/0160511 A1 8/2004 Boesen
 2005/0043056 A1 2/2005 Boesen
 2005/0125320 A1 6/2005 Boesen
 2005/0148883 A1 7/2005 Boesen
 2005/0165663 A1 7/2005 Razumov
 2005/0196009 A1 9/2005 Boesen
 2005/0251455 A1 11/2005 Boesen
 2005/0266876 A1 12/2005 Boesen
 2006/0029246 A1 2/2006 Boesen
 2006/0074671 A1 4/2006 Farmaner et al.
 2006/0074808 A1 4/2006 Boesen
 2008/0254780 A1 10/2008 Kuhl et al.
 2009/0245559 A1 10/2009 Boltyenkov et al.
 2017/0111726 A1 4/2017 Martin et al.
 2017/0155992 A1 6/2017 Perianu et al.

FOREIGN PATENT DOCUMENTS

JP 06292195 10/1998
 WO 2014043179 A2 3/2014
 WO 2015110577 A1 7/2015
 WO 2015110587 A1 7/2015

OTHER PUBLICATIONS

BRAGI is on Facebook (2014).
 Bragi Update—Arrival of Prototype Chassis Parts—More People—
 Awesomeness (May 13, 2014).

(56)

References Cited

OTHER PUBLICATIONS

Bragi Update—Chinese New Year, Design Verification, Charging Case, More People, Timeline(Mar. 6, 2015).
 Bragi Update—First Sleeves From Prototype Tool—Software Development Kit (Jun. 5, 2014).
 Bragi Update—Let’s Get Ready to Rumble, A Lot to Be Done Over Christmas (Dec. 22, 2014).
 Bragi Update—Memories From April—Update on Progress (Sep. 16, 2014).
 Bragi Update—Memories from May—Update on Progress—Sweet (Oct. 13, 2014).
 Bragi Update—Memories From One Month Before Kickstarter—Update on Progress (Jul. 10, 2014).
 Bragi Update—Memories From the First Month of Kickstarter—Update on Progress (Aug. 1, 2014).
 Bragi Update—Memories From the Second Month of Kickstarter—Update on Progress (Aug. 22, 2014).
 Bragi Update—New People @BRAGI—Prototypes (Jun. 26, 2014).
 Bragi Update—Office Tour, Tour to China, Tour to CES (Dec. 11, 2014).
 Bragi Update—Status on Wireless, Bits and Pieces, Testing—Oh Yeah, Timeline(Apr. 24, 2015).
 Bragi Update—The App Preview, The Charger, The SDK, BRAGI Funding and Chinese New Year (Feb. 11, 2015).
 Bragi Update—What We Did Over Christmas, Las Vegas & CES (Jan. 19, 2014).
 Bragi Update—Years of Development, Moments of Utter Joy and Finishing What We Started(Jun. 5, 2015).

Bragi Update—Alpha 5 and Back to China, Backer Day, on Track(May 16, 2015).
 Bragi Update—Beta2 Production and Factory Line(Aug. 20, 2015).
 Bragi Update—Certifications, Production, Ramping Up.
 Bragi Update—Developer Units Shipping and Status(Oct. 5, 2015).
 Bragi Update—Developer Units Started Shipping and Status (Oct. 19, 2015).
 Bragi Update—Developer Units, Investment, Story and Status(Nov. 2, 2015).
 Bragi Update—Getting Close(Aug. 6, 2014).
 Bragi Update—On Track, Design Verification, How It Works and What’s Next(Jul. 15, 2015).
 Bragi Update—On Track, on Track and Gems Overview.
 Bragi Update—Status on Wireless, Supply, Timeline and Open House@BRAGI(Apr. 1, 2015).
 Bragi Update—Unpacking Video, Reviews on Audio Perform and Boy Are We Getting Close(Sep. 10, 2015).
 Last Push Before the Kickstarter Campaign Ends on Monday 4pm CET (Mar. 28, 2014).
 Staab, Wayne J., et al., “A One-Size Disposable Hearing Aid is Introduced”, The Hearing Journal 53(4):36-41) Apr. 2000.
 Stretchgoal—It’s Your Dash (Feb. 14, 2014).
 Stretchgoal—The Carrying Case for the Dash (Feb. 12, 2014).
 Stretchgoal—Windows Phone Support (Feb. 17, 2014).
 The Dash + The Charging Case & The Bragi News (Feb. 21, 2014).
 The Dash—A Word From Our Software, Mechanical and Acoustics Team + An Update (Mar. 11, 2014).
 Update From Bragi—\$3,000,000—Yipee (Mar. 22, 2014).

* cited by examiner

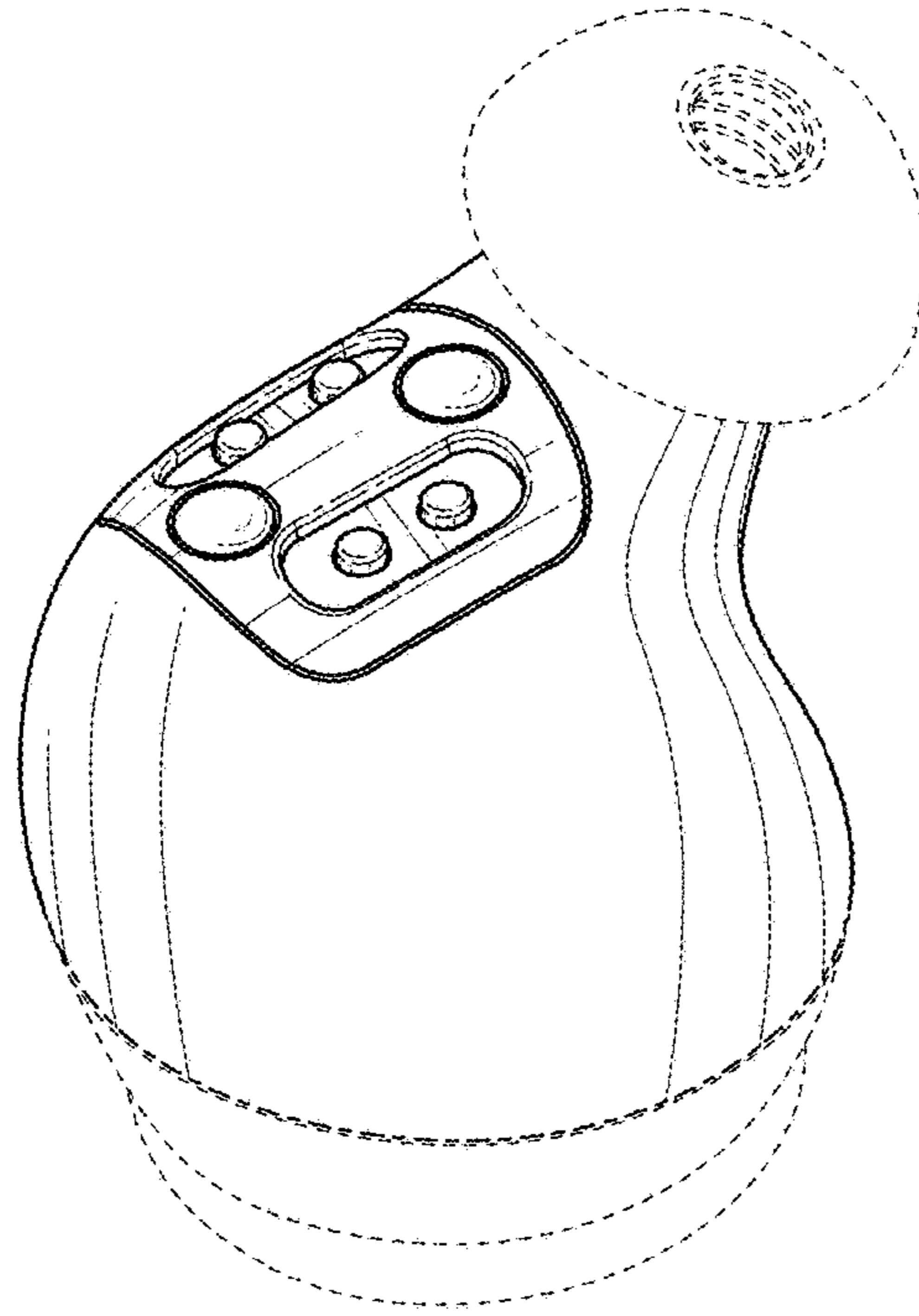

FIG. 1

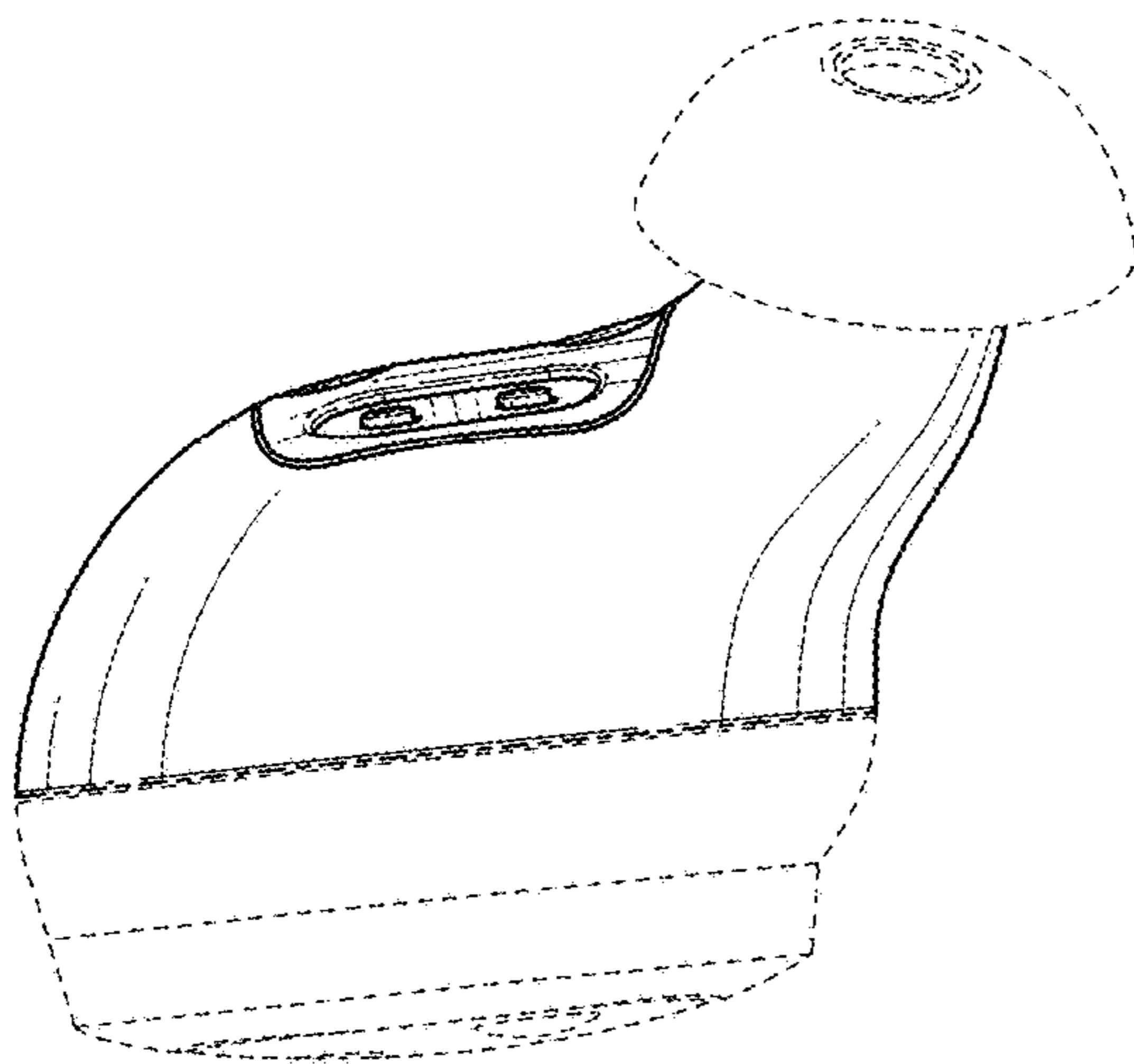

FIG. 2

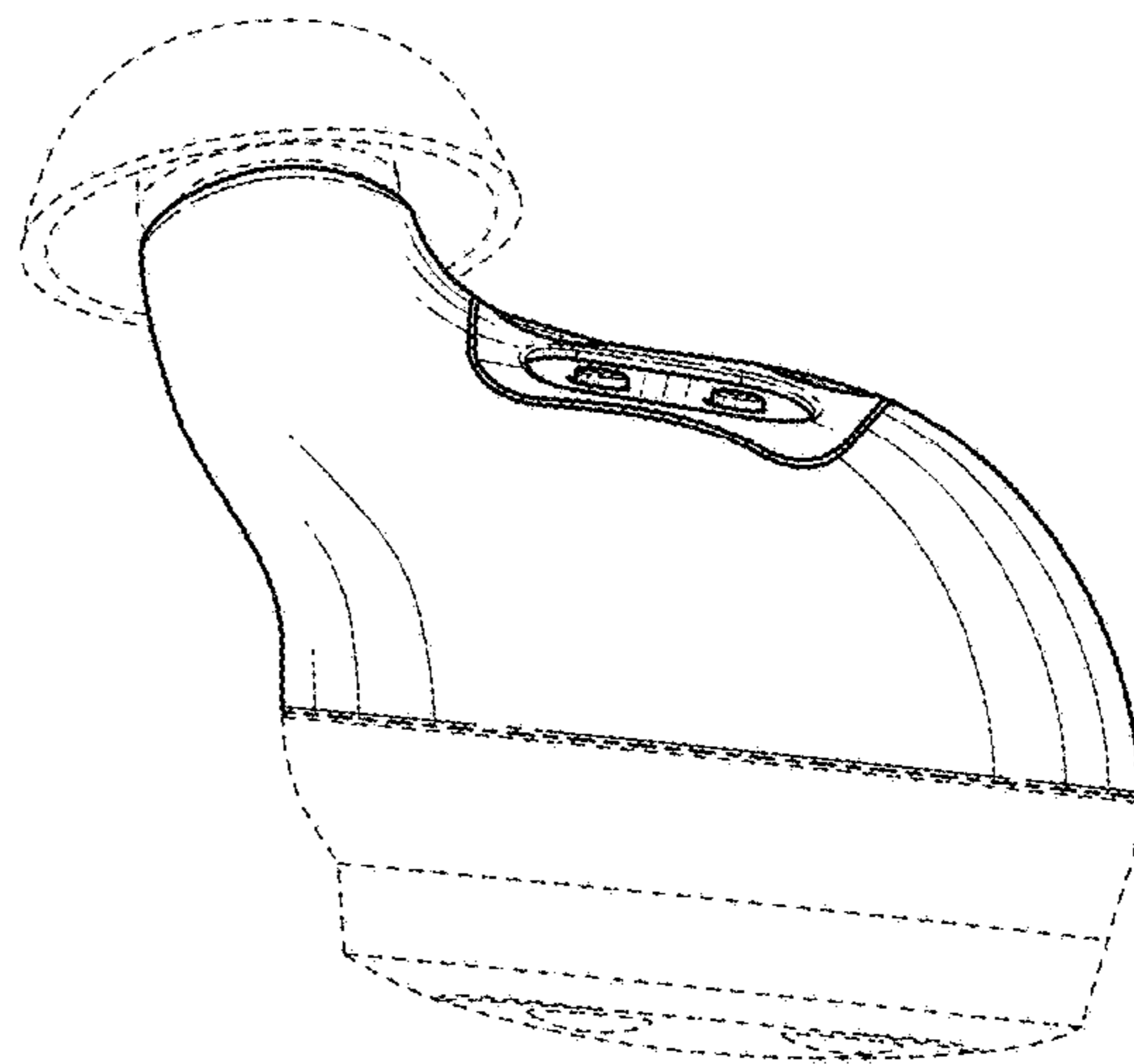

FIG. 3

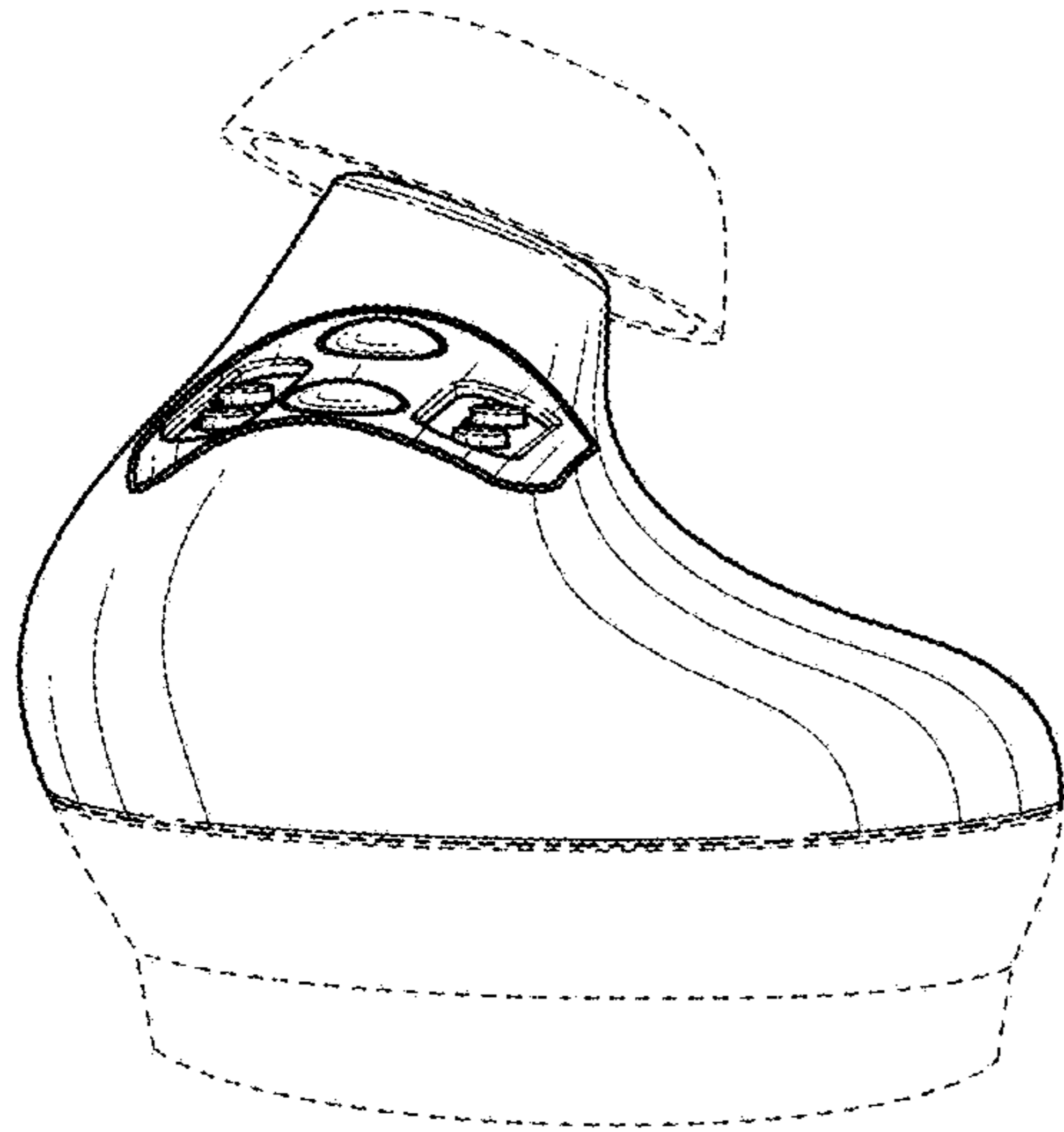

FIG. 4

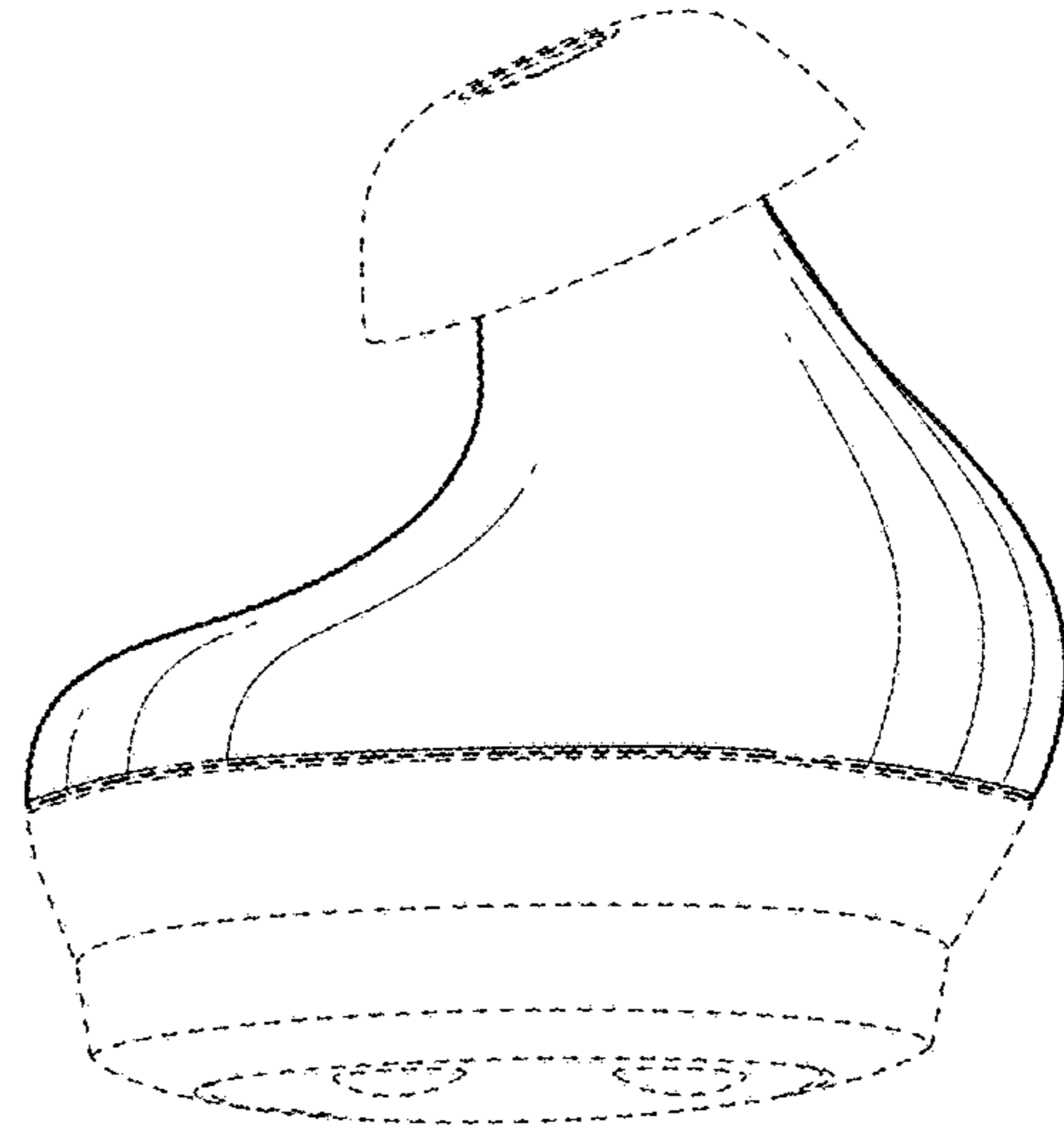

FIG. 5

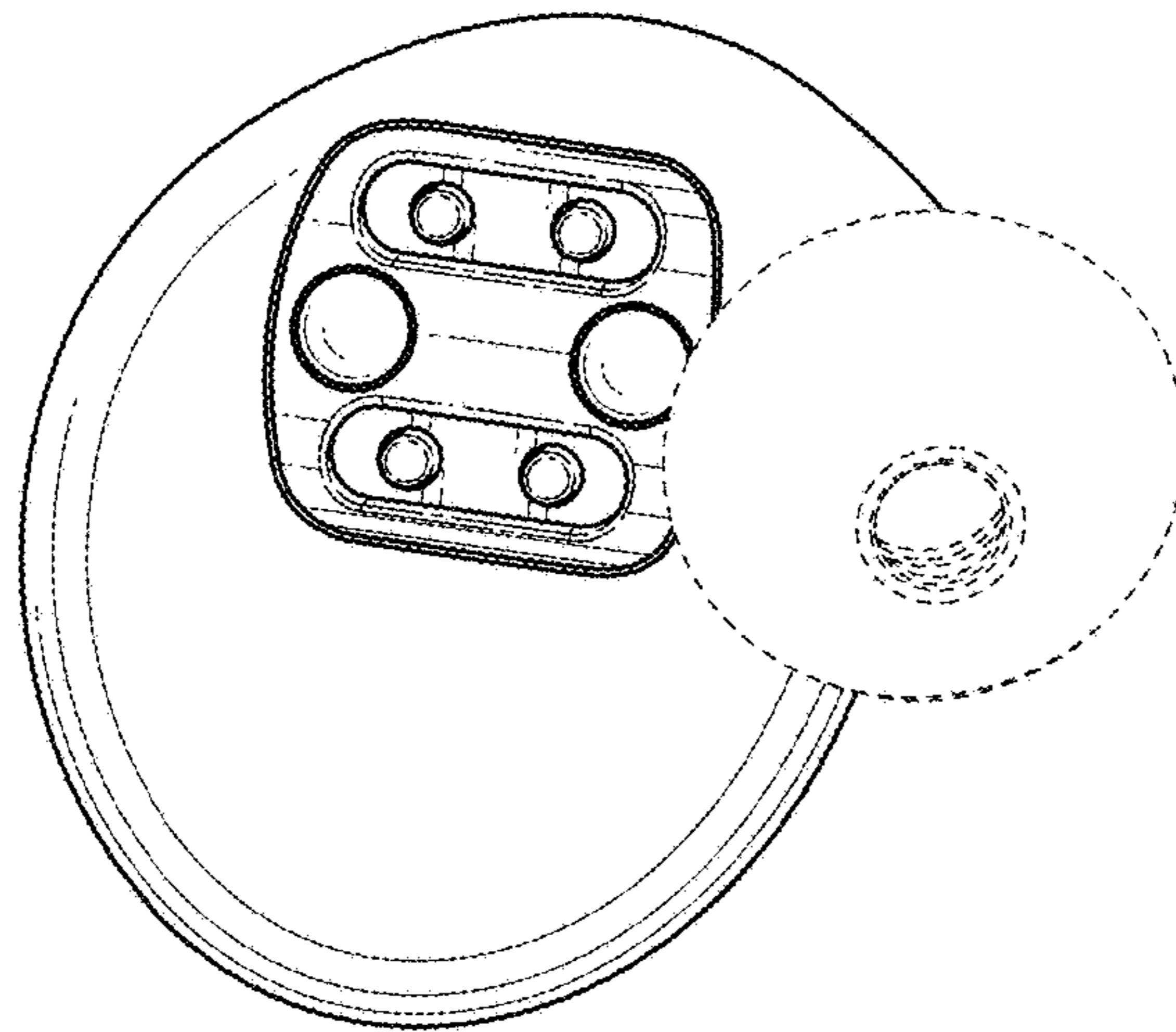

FIG. 6

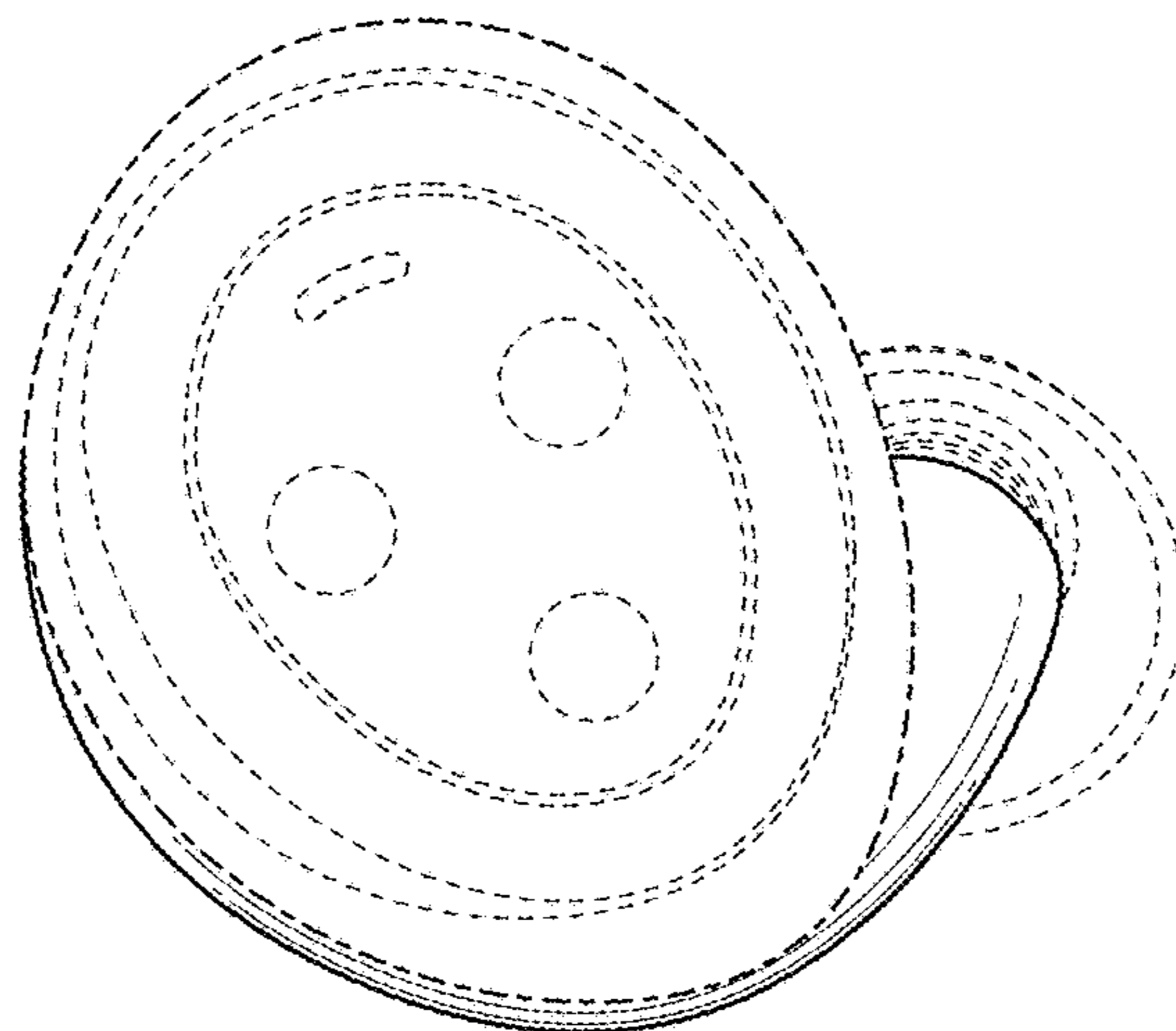

FIG. 7