



US00D822502S

(12) **United States Design Patent**
Krunas

(10) **Patent No.:** **US D822,502 S**
(45) **Date of Patent:** **** Jul. 10, 2018**

(54) **PERFUME BOTTLE**

(71) Applicant: **PRESTIGE ET COLLECTIONS INTERNATIONAL**, Paris (FR)

(72) Inventor: **Catherine Krunas**, Paris (FR)

(**) Term: **15 Years**

(21) Appl. No.: **35/502,738**

(22) Filed: **Mar. 16, 2017**

(80) **Hague Agreement Data**
 Int. Filing Date: **Mar. 16, 2017**
 Int. Reg. No.: **DM/095367**
 Int. Reg. Date: **Mar. 16, 2017**
 Int. Reg. Pub. Date: **Mar. 31, 2017**

(51) **LOC (11) Cl.** **09-01**

(52) **U.S. Cl.**
 USPC **D9/691**

(58) **Field of Classification Search**
 USPC D9/691, 521, 649, 546, 435, 550, 516,
 D9/542, 741, 559, 544, 541, 454, 601,
 D9/669, 522, 573, 563; D28/91.1;
 D7/679, 523; 215/12.1
 CPC A45D 34/02
 See application file for complete search history.

D442,475 S * 5/2001 Krunas D9/601
 D442,477 S * 5/2001 Krunas D9/669
 D481,634 S * 11/2003 Legros D9/516
 D496,286 S * 9/2004 Krunas D9/454
 D500,448 S * 1/2005 Krunas D9/544
 D513,188 S * 12/2005 Bertrand D9/541
 D517,416 S * 3/2006 Borgerson D9/542
 D520,879 S * 5/2006 Antretter D28/91.1
 D531,912 S * 11/2006 Antretter D9/546
 D545,146 S * 6/2007 Marshall D7/679
 D605,948 S * 12/2009 Sposato D9/546
 D608,651 S * 1/2010 Eisen D9/435
 D622,613 S * 8/2010 Baron D9/550
 D623,521 S * 9/2010 Marotti D9/516
 D696,132 S * 12/2013 Krunas D9/542
 D737,689 S * 9/2015 Monteparo D9/435
 D755,571 S * 5/2016 Cheng D7/523
 D764,298 S * 8/2016 Gordon D9/541
 D766,738 S * 9/2016 Buckner, III D9/741
 D784,152 S * 4/2017 Krunas D9/559
 D796,959 S * 9/2017 Krunas D9/521
 D798,162 S * 9/2017 Hatellari D9/649

* cited by examiner

Primary Examiner — Rhea Shields

(57) **CLAIM**

The ornamental design for a perfume bottle, as shown and described.

DESCRIPTION

- 1. Perfume bottle
- 1.1 : Top
- 1.2 : Bottom
- 1.3 : Right
- 1.4 : Left
- 1.5 : Front
- 1.6 : Back
- 1.7 : Perspective

1 Claim, 7 Drawing Sheets

(56) **References Cited**
 U.S. PATENT DOCUMENTS

1,887,298 A * 11/1932 Friedman A45D 34/02
 215/12.1

D400,107 S * 10/1998 Krunas D9/563
 D401,509 S * 11/1998 Krunas D9/573
 D438,097 S * 2/2001 Krunas D9/522
 D438,098 S * 2/2001 Krunas D9/691
 D438,802 S * 3/2001 Krunas D9/522

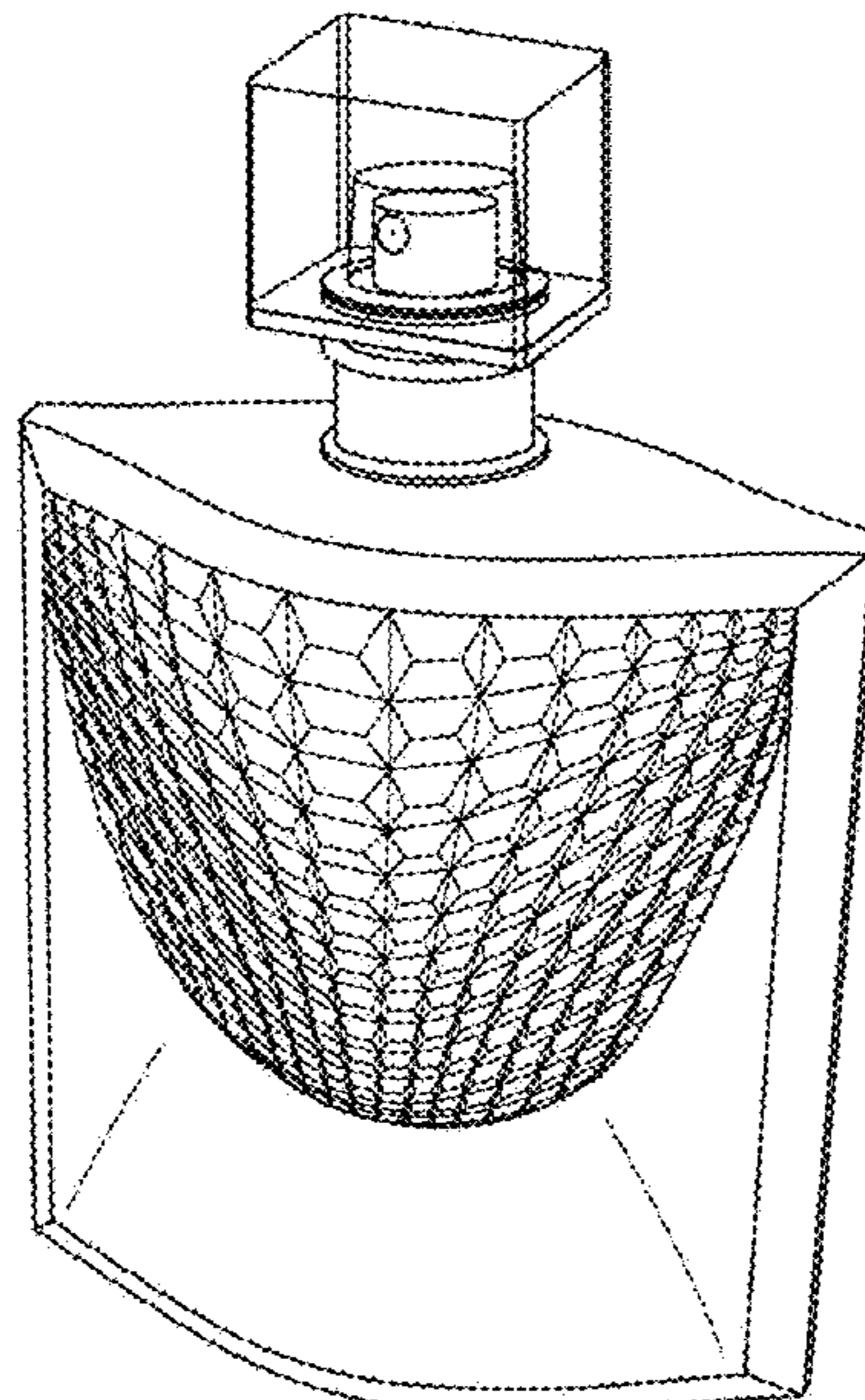

1.1

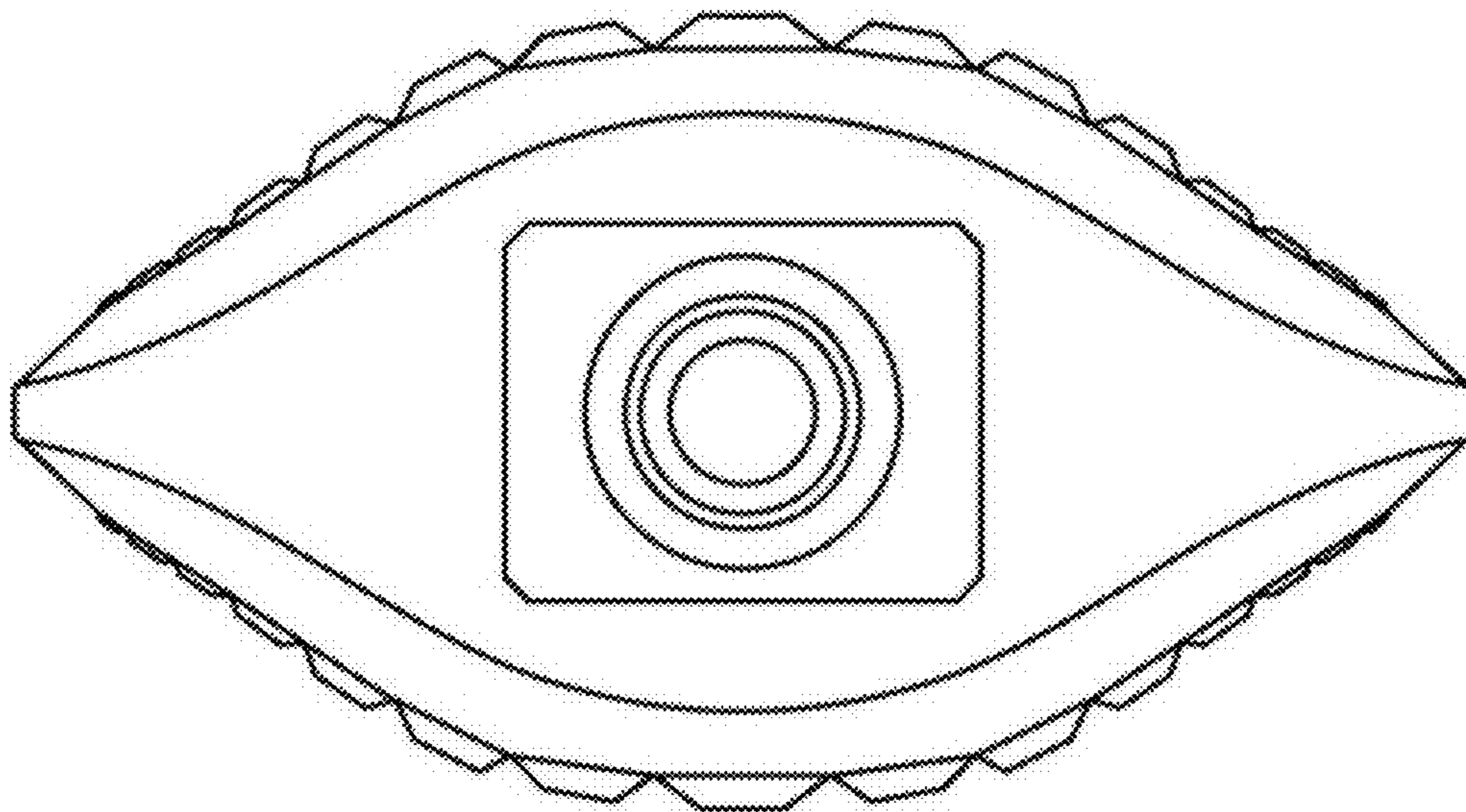

1.2

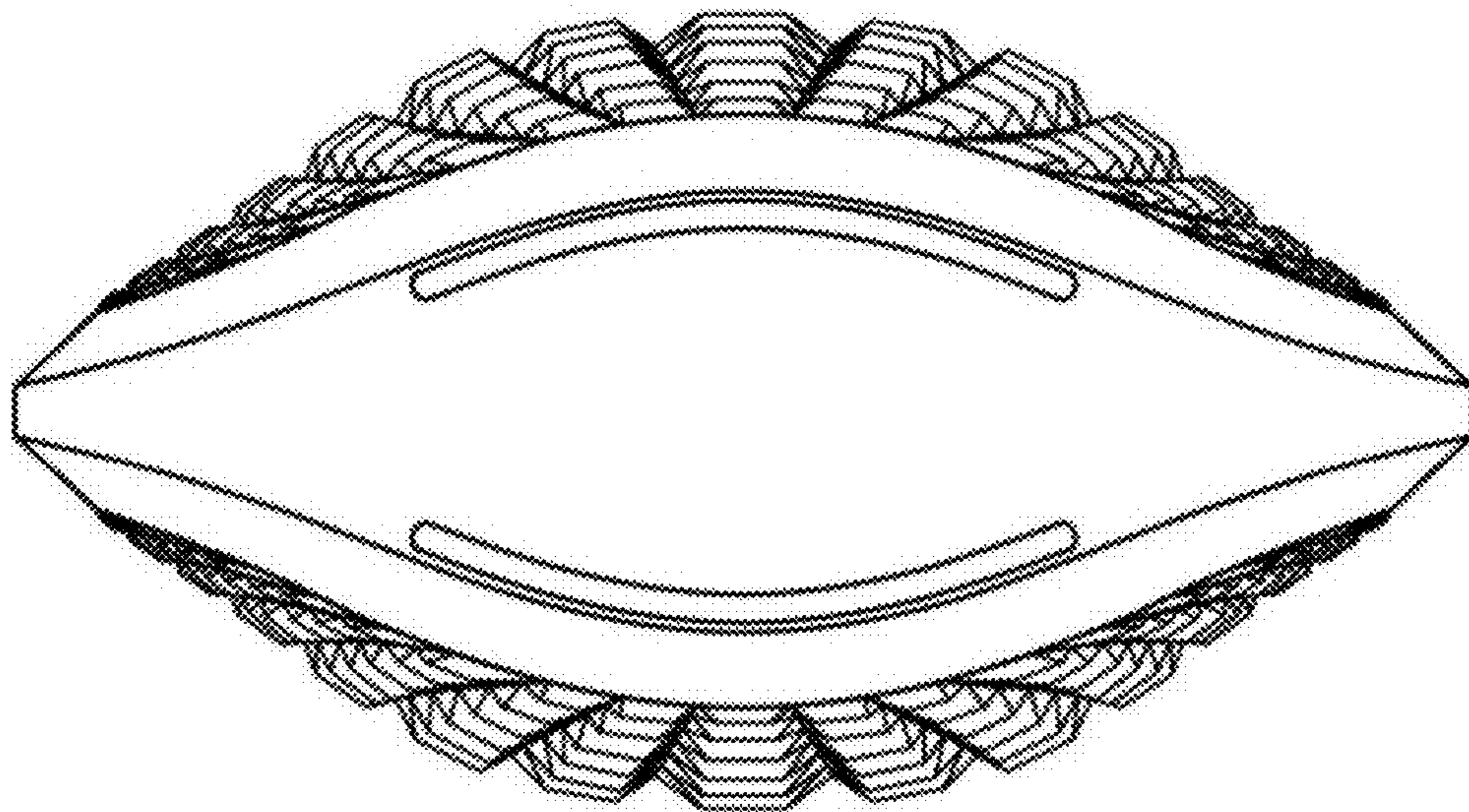

1.3

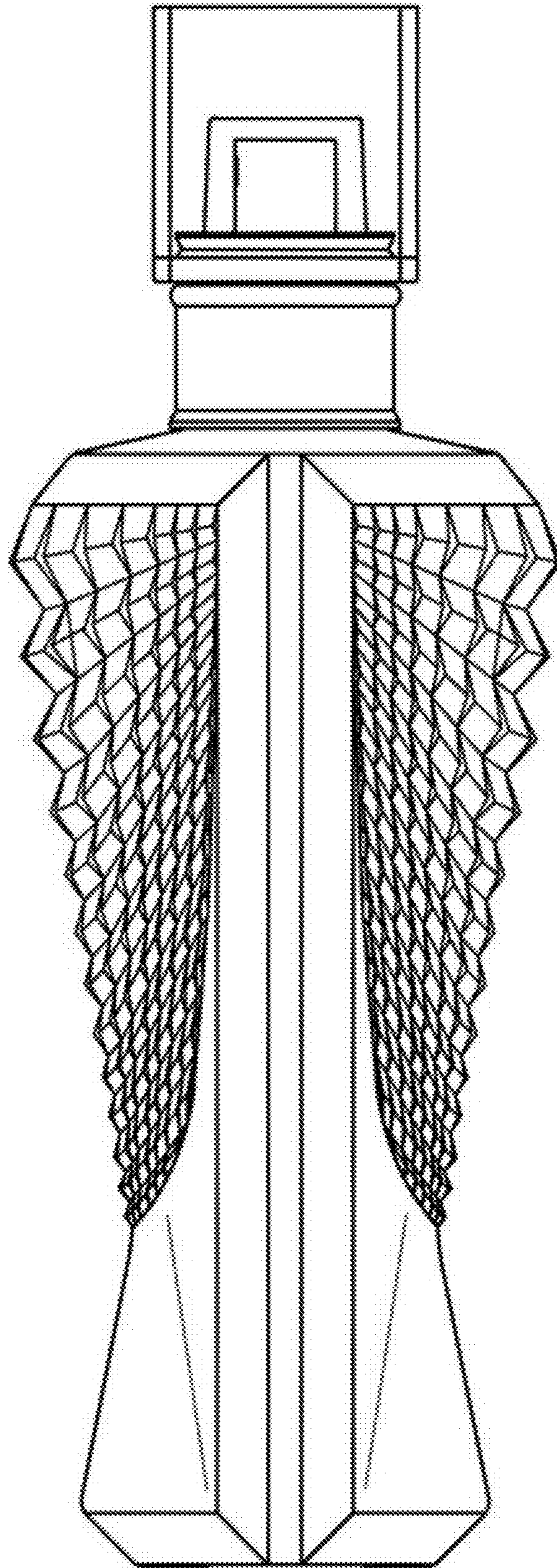

1.4

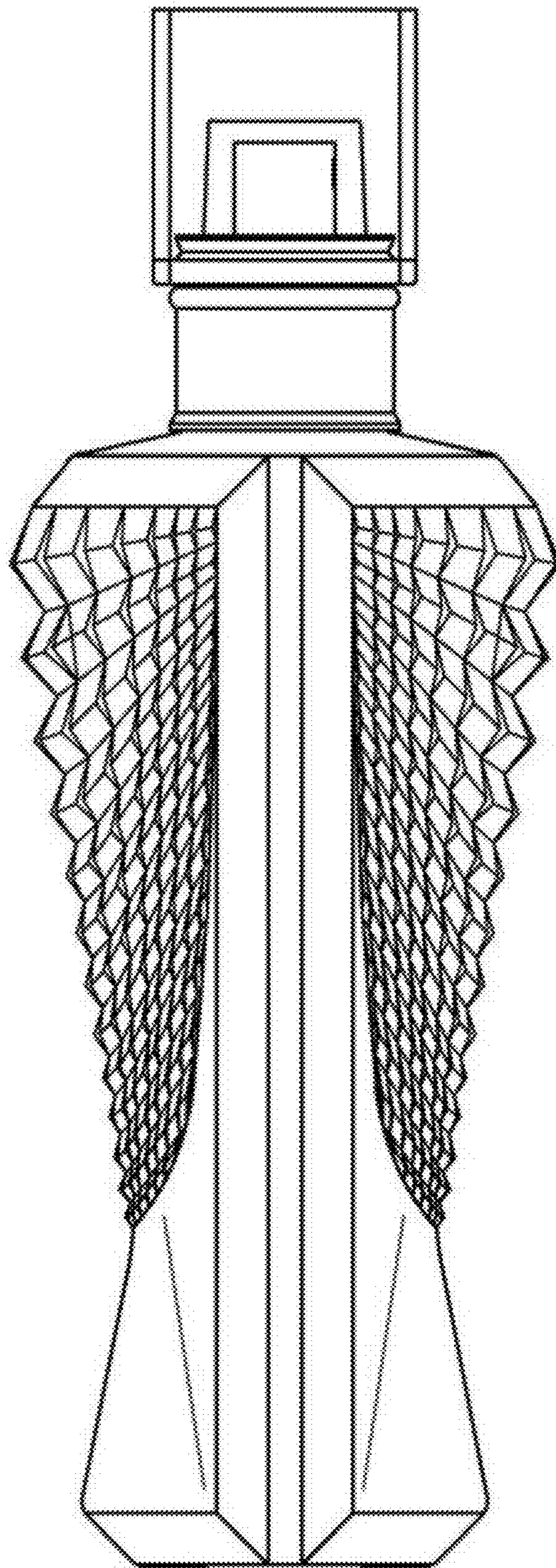

1.5

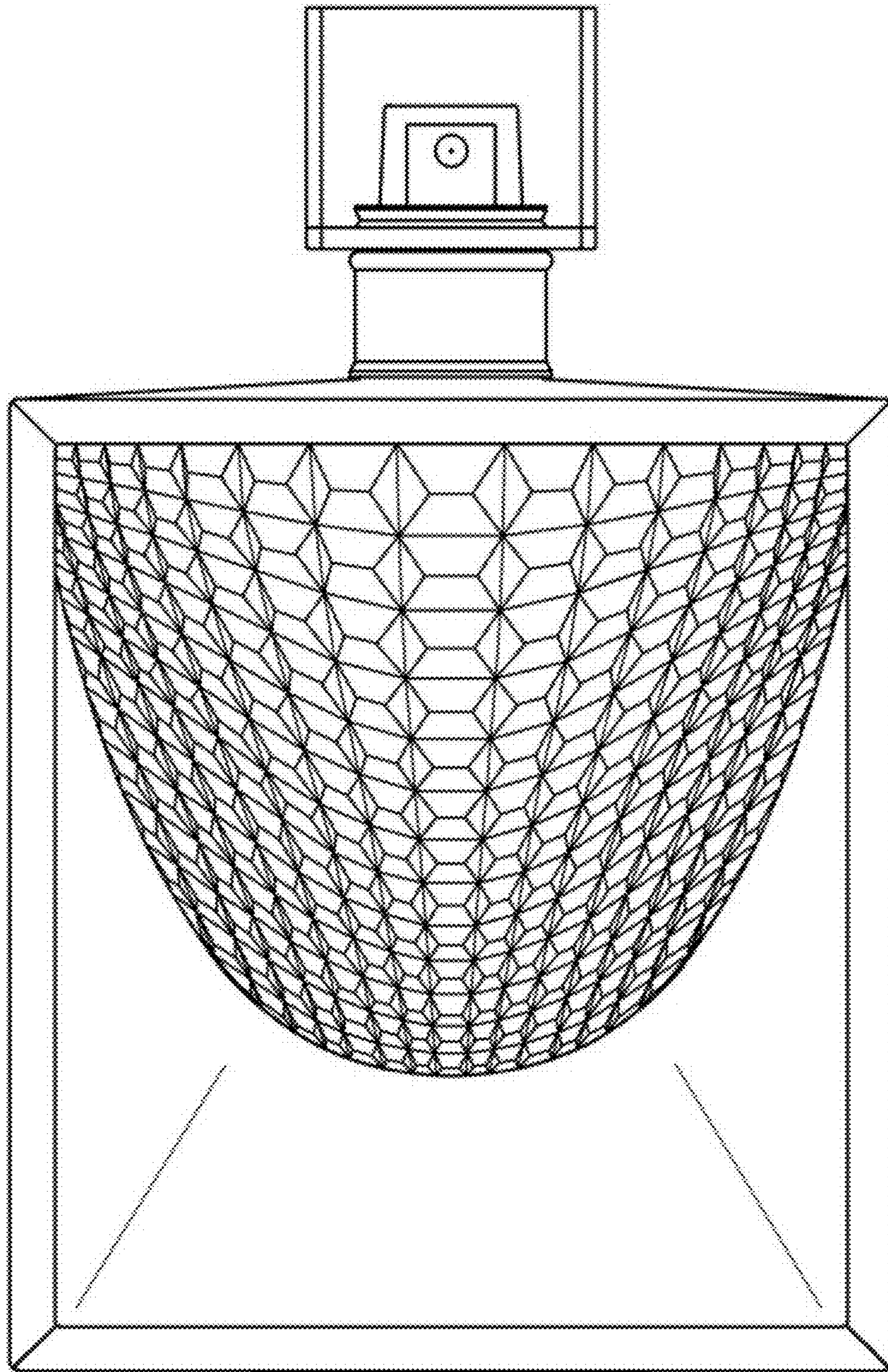

1.6

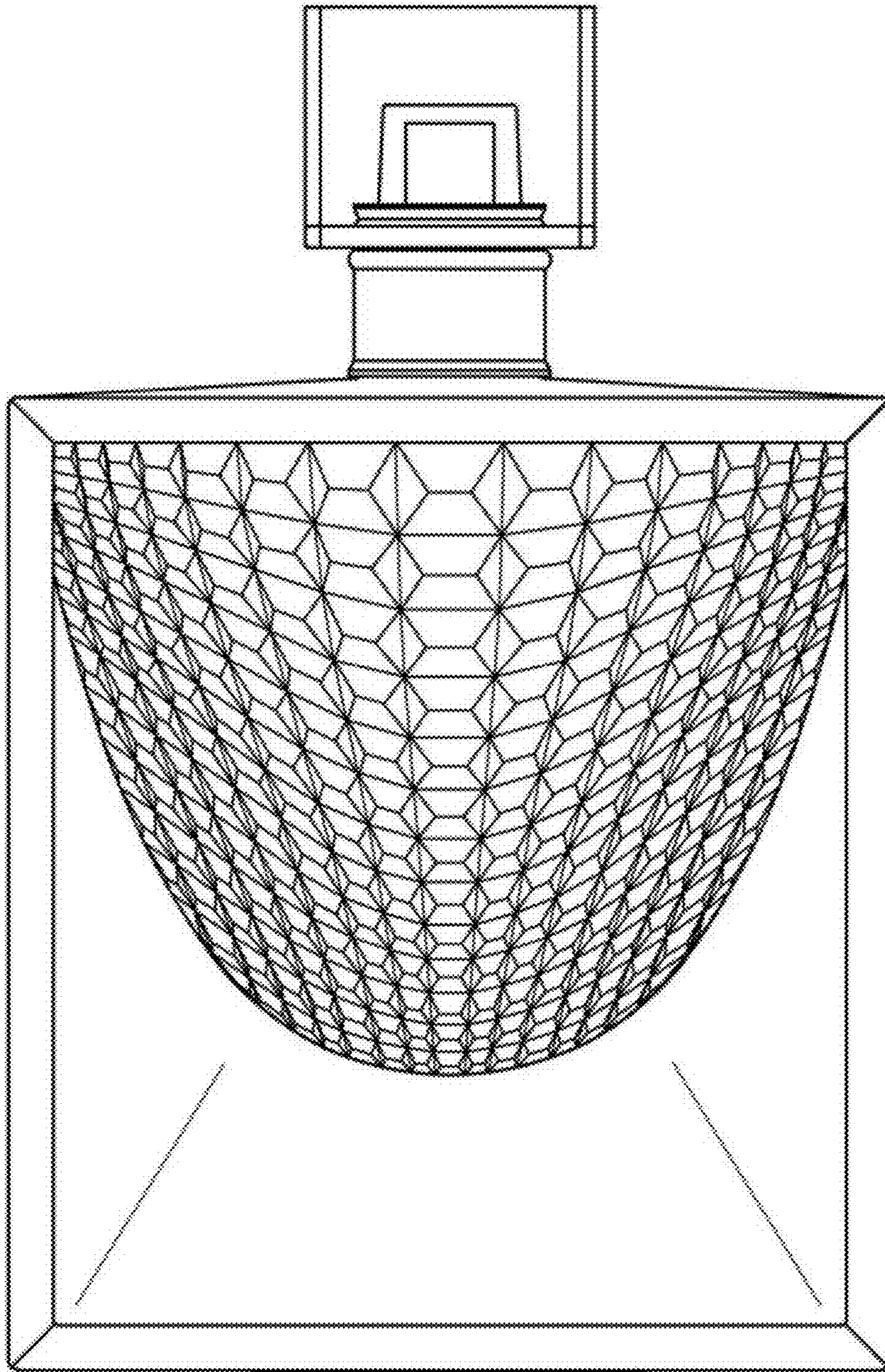

1.7

