



US00D822498S

(12) **United States Design Patent** (10) **Patent No.:** **US D822,498 S**
Sutcliffe (45) **Date of Patent:** **** Jul. 10, 2018**

(54) **CONTAINER**

(71) Applicant: **Rockit Global Limited**, Hawke's Bay (NZ)

(72) Inventor: **David John Sutcliffe**, Auckland (NZ)

(73) Assignee: **Rockit Global Limited**, Hawke's Bay (NZ)

(**) Term: **15 Years**

(21) Appl. No.: **29/606,156**

(22) Filed: **Jun. 1, 2017**

(51) **LOC (11) Cl.** **09-01**

(52) **U.S. Cl.**
USPC **D9/645**; D9/780; D9/451; D9/454; D9/549

(58) **Field of Classification Search**
USPC D3/270, 271.1-271.4; D7/509-511, D7/514-520, 523, 529, 598, 599, 604, (Continued)

(56) **References Cited**

U.S. PATENT DOCUMENTS

D203,629 S * 2/1966 Brock D9/780
D205,686 S * 9/1966 Marchant D9/779
(Continued)

Primary Examiner — Sandra L Morris

(74) *Attorney, Agent, or Firm* — Baker & McKenzie LLP

(57) **CLAIM**

The ornamental design for a container, as shown and described.

DESCRIPTION

FIG. 1 is a front perspective view of my new design in a closed position;

FIG. 2 is a front elevation view of my new design in a closed position;

FIG. 3 is a rear elevation view of my new design in a closed position;

FIG. 4 is a right elevation view of my new design in a closed position;

FIG. 5 is a left elevation view of my new design in a closed position;

FIG. 6 is a top plan view of my new design in a closed position;

FIG. 7 is a bottom plan view of my new design in a closed position;

FIG. 8 is a rear perspective view of my new design in a closed position;

FIG. 9 is a front perspective view of my new design with lid removed;

FIG. 10 is a front elevation view of my new design with lid removed;

FIG. 11 is a rear elevation view of my new design with lid removed;

FIG. 12 is a right elevation view of my new design with lid removed;

FIG. 13 is a left elevation view of my new design with lid removed;

FIG. 14 is a top plan view of my new design with lid removed;

FIG. 15 is a bottom plan view of my new design with lid removed;

FIG. 16 is a rear perspective view of my new design with lid removed;

FIG. 17 is an enlarged front perspective view of my new design lid shown separately;

FIG. 18 is an enlarged front elevation view of my new design lid shown separately;

FIG. 19 is an enlarged rear elevation view of my new design lid shown separately;

FIG. 20 is an enlarged right elevation view of my new design lid shown separately;

FIG. 21 is an enlarged left elevation view of my new design lid shown separately;

FIG. 22 is an enlarged top plan view of my new design lid shown separately; and,

FIG. 23 is an enlarged bottom plan view of my new design lid shown separately.

(Continued)

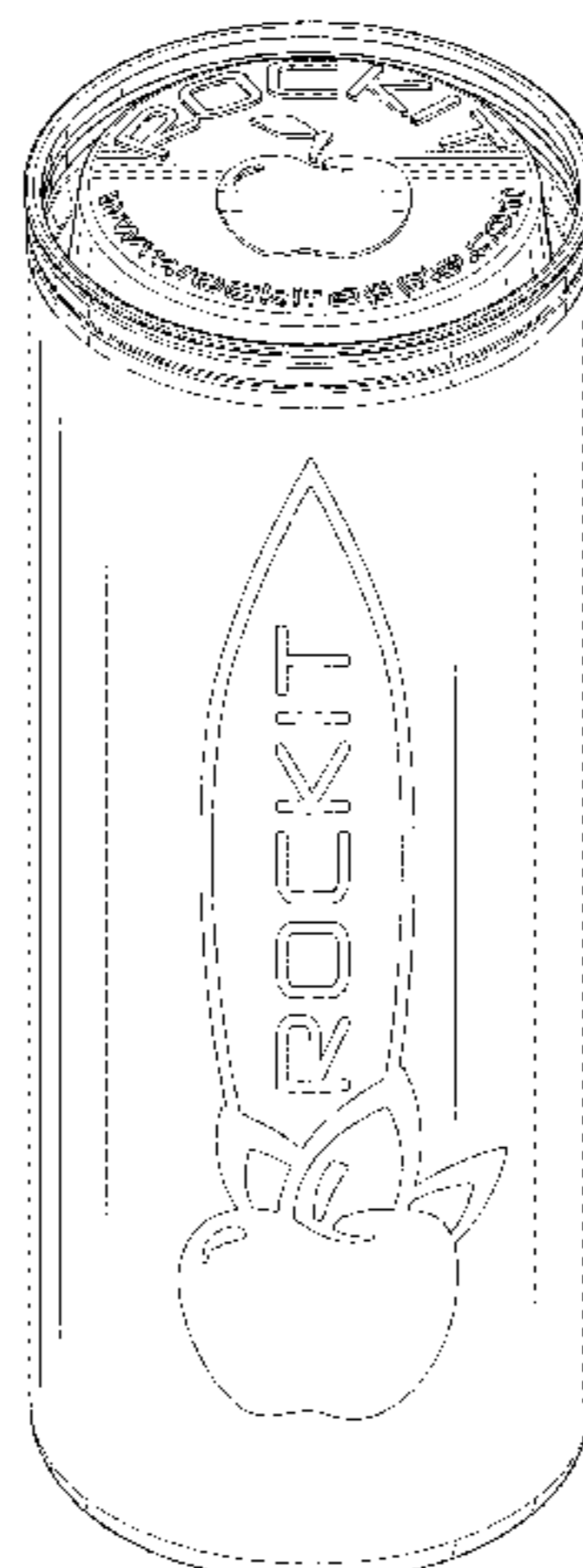

The broken line showing is for illustrative purposes only,
and forms no part of the claimed design.

1 Claim, 18 Drawing Sheets

(58) Field of Classification Search

USPC D7/613, 619.2, 623, 628; D9/600,
D9/643-647, 763, 772-775, 777-780,
D9/500-516, 537-545, 549-551, 441,
D9/451, 454; 206/457, 459.5, 527;
215/381-384, 400
CPC B65D 5/4258; B65D 81/60; B65D 81/365;
B65D 81/366; B65D 81/368; B65D
2203/00; B65D 2203/02

See application file for complete search history.

(56) References Cited

U.S. PATENT DOCUMENTS

D241,017 S *	8/1976	Baker	D9/779
D248,544 S *	7/1978	Saunders	D9/780
D259,768 S *	7/1981	Banasiak, Jr.	D9/505
D263,024 S *	2/1982	Atkinson	D9/780
D265,548 S *	7/1982	Brundige	D9/780
D385,778 S *	11/1997	Luh	D9/645
D388,697 S *	1/1998	Luh	D9/645
D399,734 S *	10/1998	Luh	D9/645
D510,034 S *	9/2005	Hong	D9/645
D618,115 S *	6/2010	Huls	D9/772
D671,837 S *	12/2012	Rosenberg	D9/504
D715,162 S *	10/2014	Farrow	D9/772
D722,273 S *	2/2015	Ivie	D9/500
D767,998 S *	10/2016	Peacock	D9/645
D767,999 S *	10/2016	Yourist	D9/516

* cited by examiner

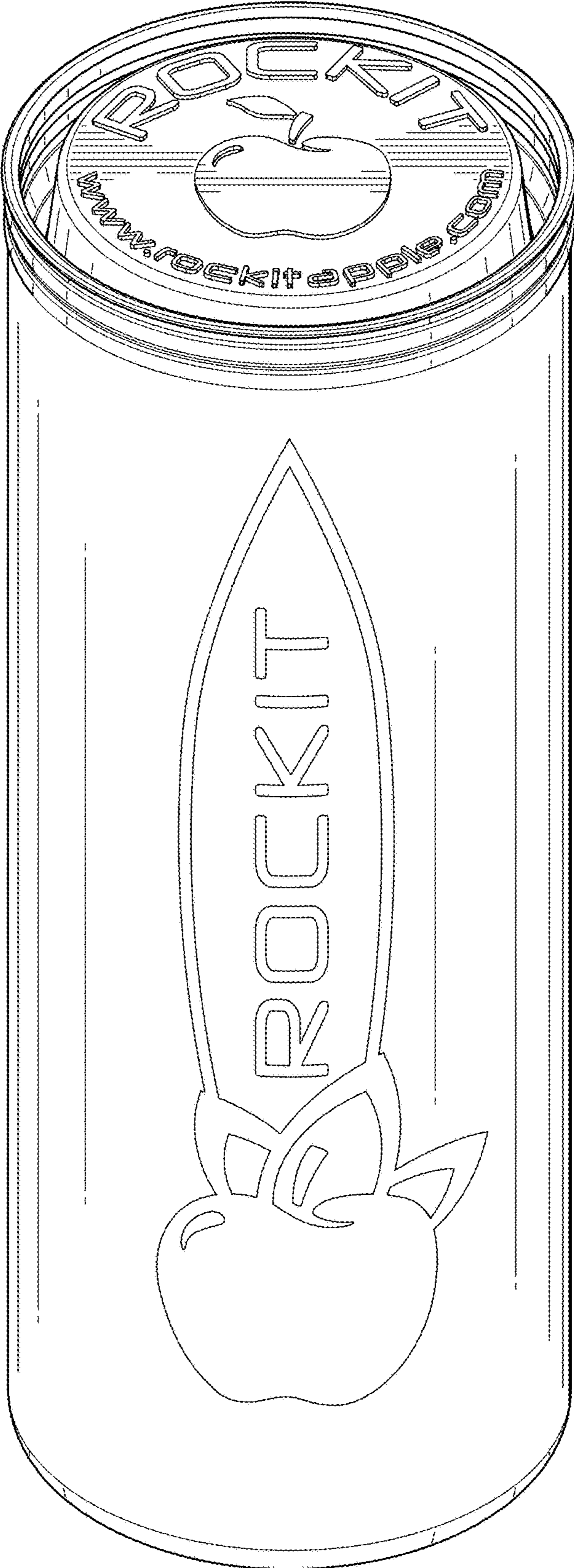

FIG. 1

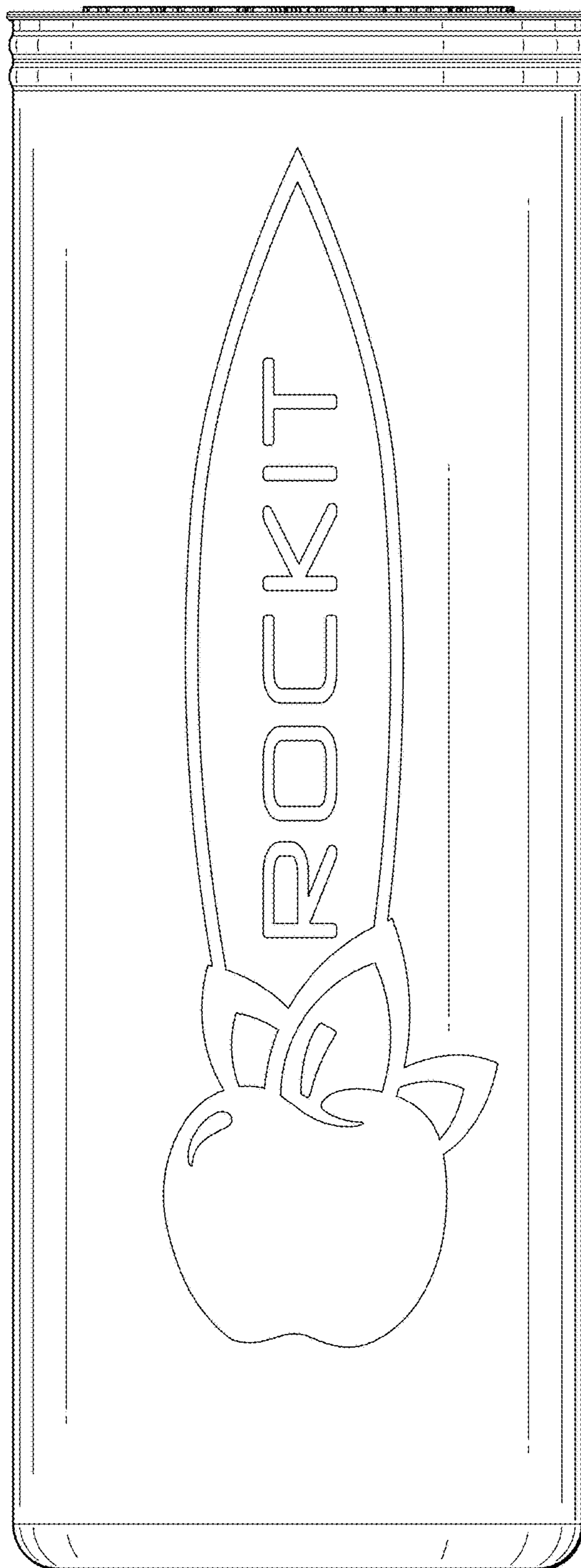

FIG. 2

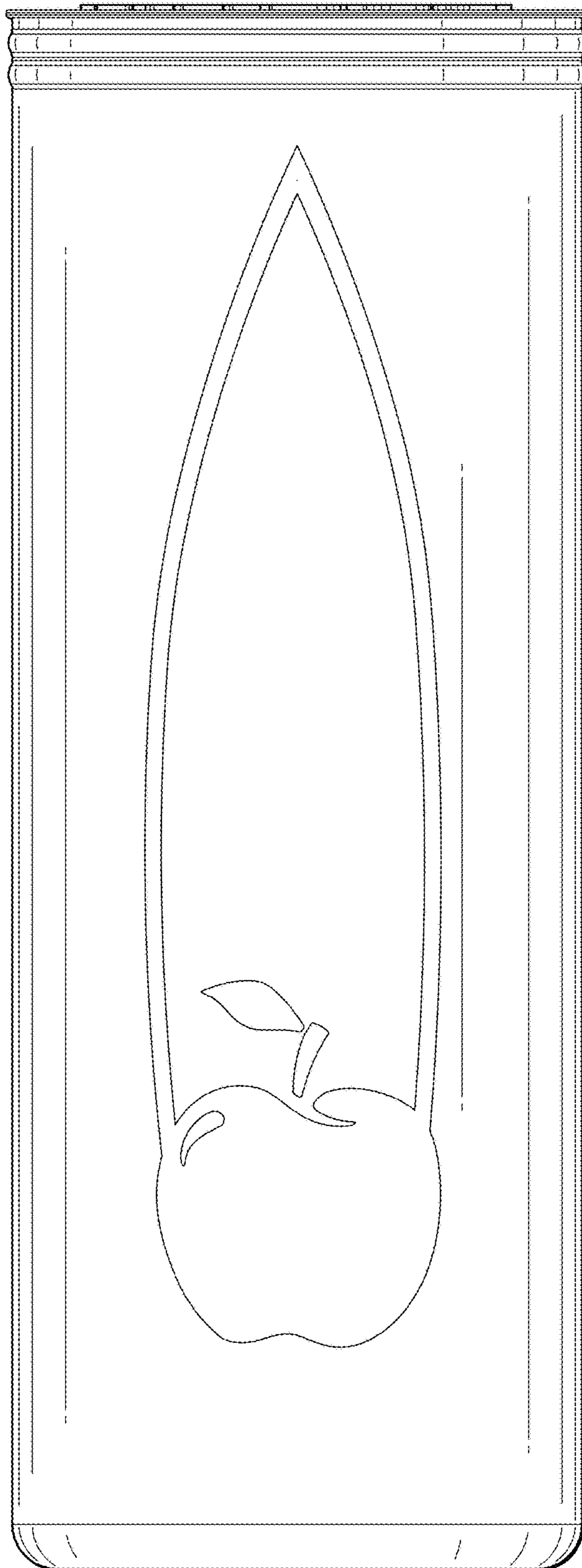

FIG. 3

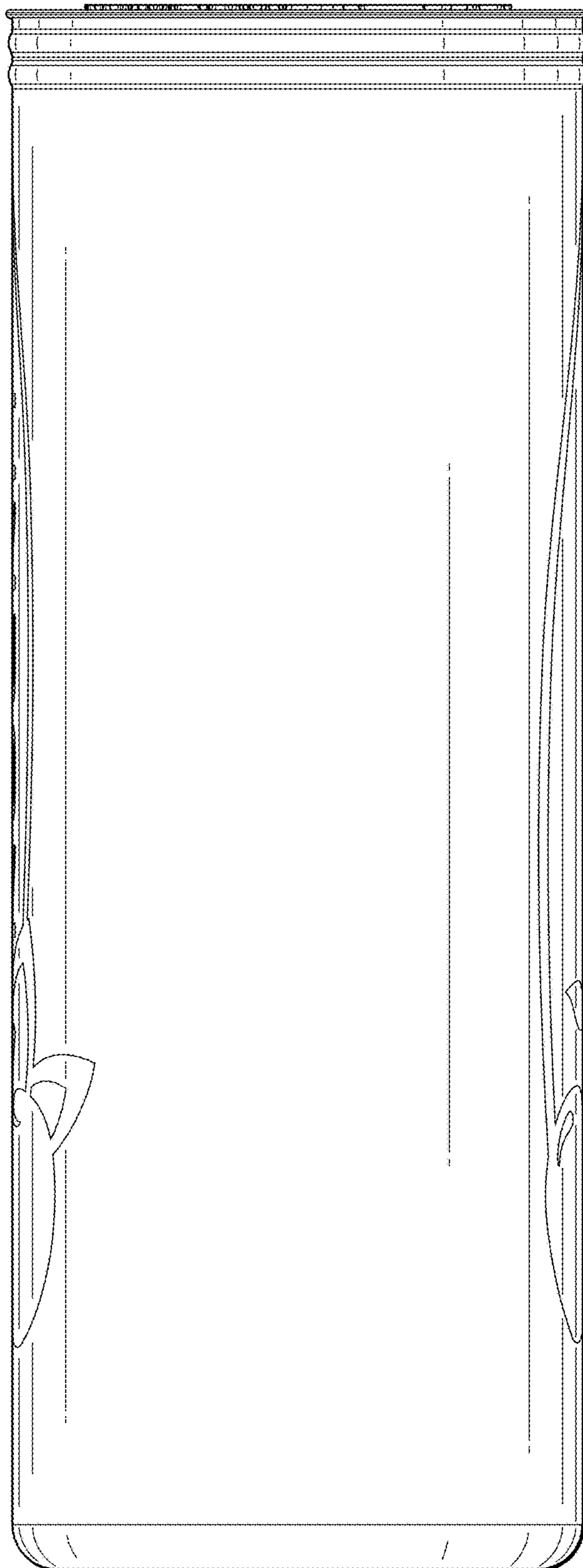

FIG. 4

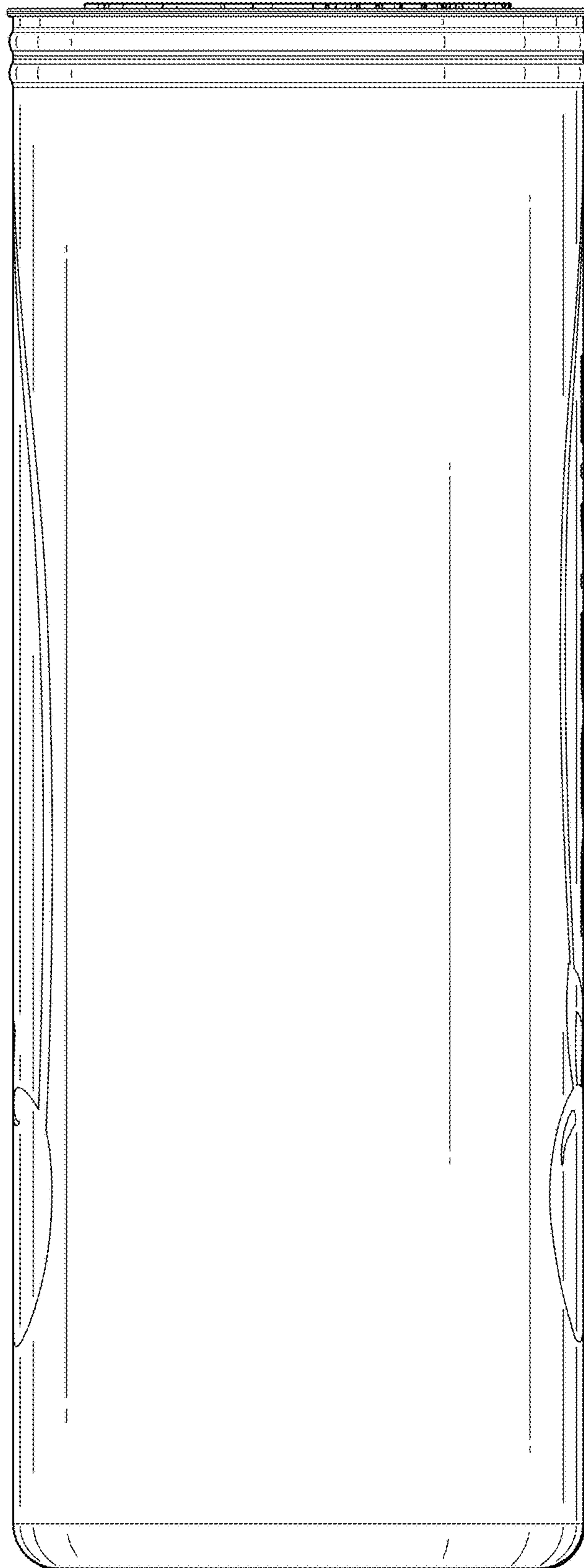

FIG. 5

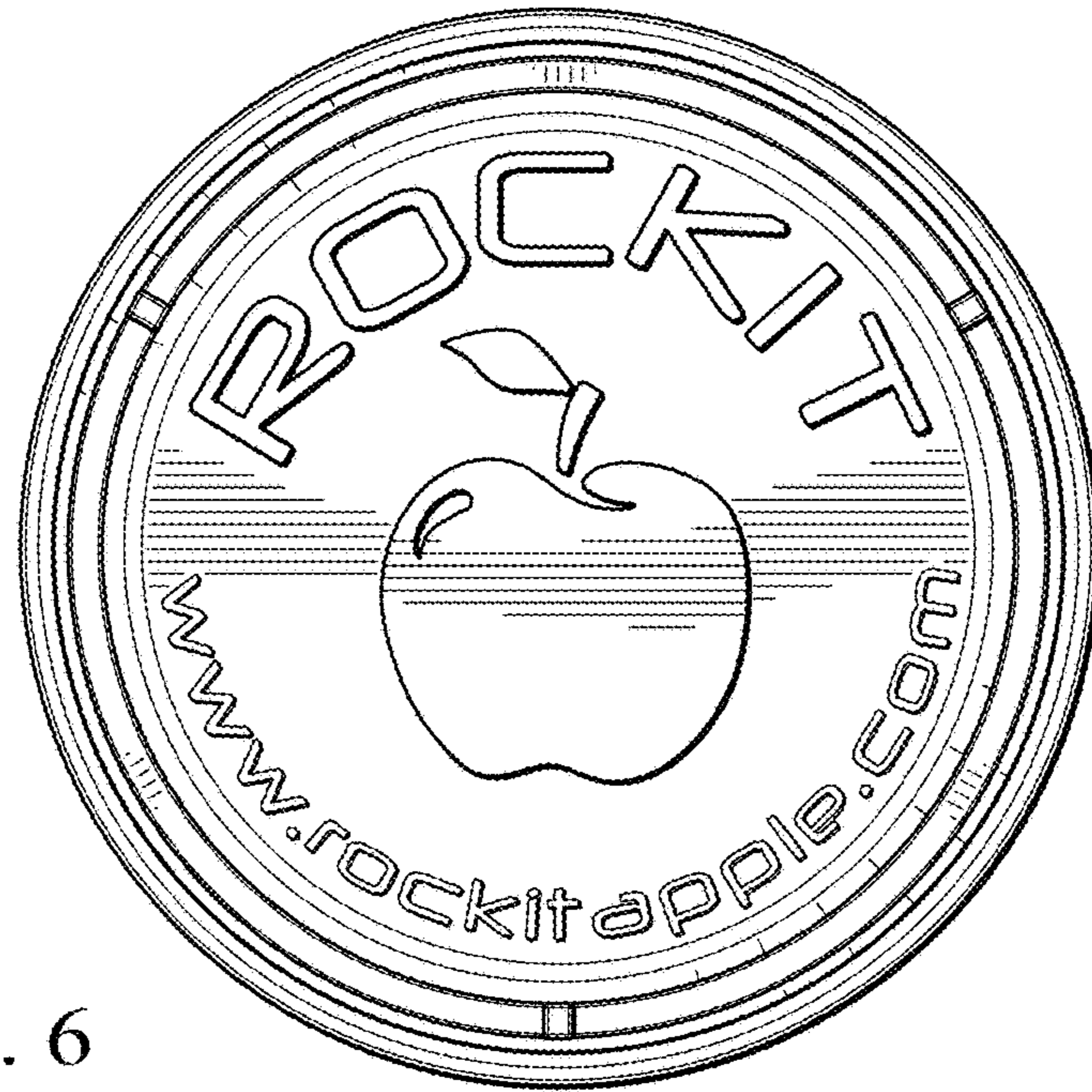

FIG. 6

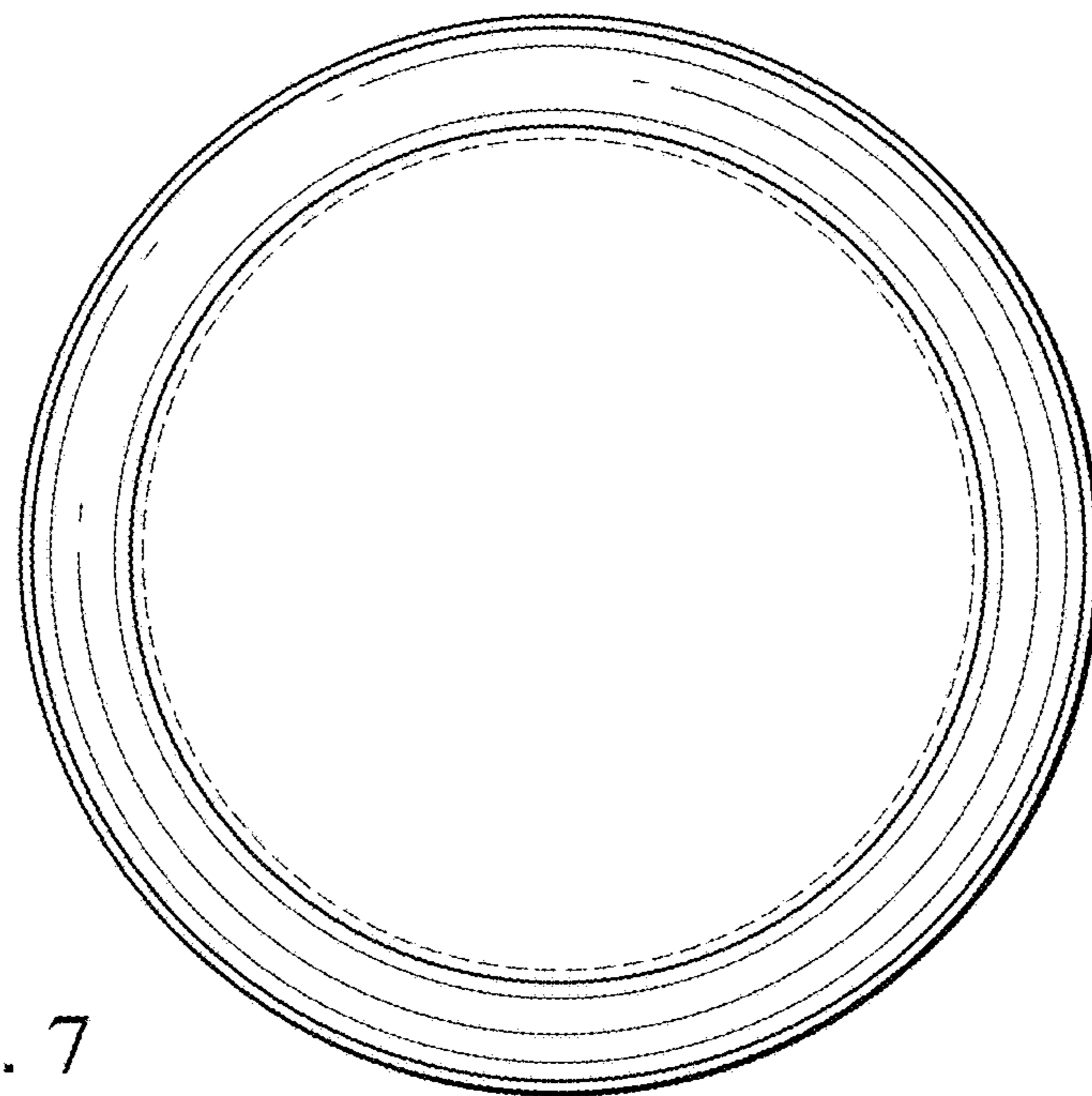

FIG. 7

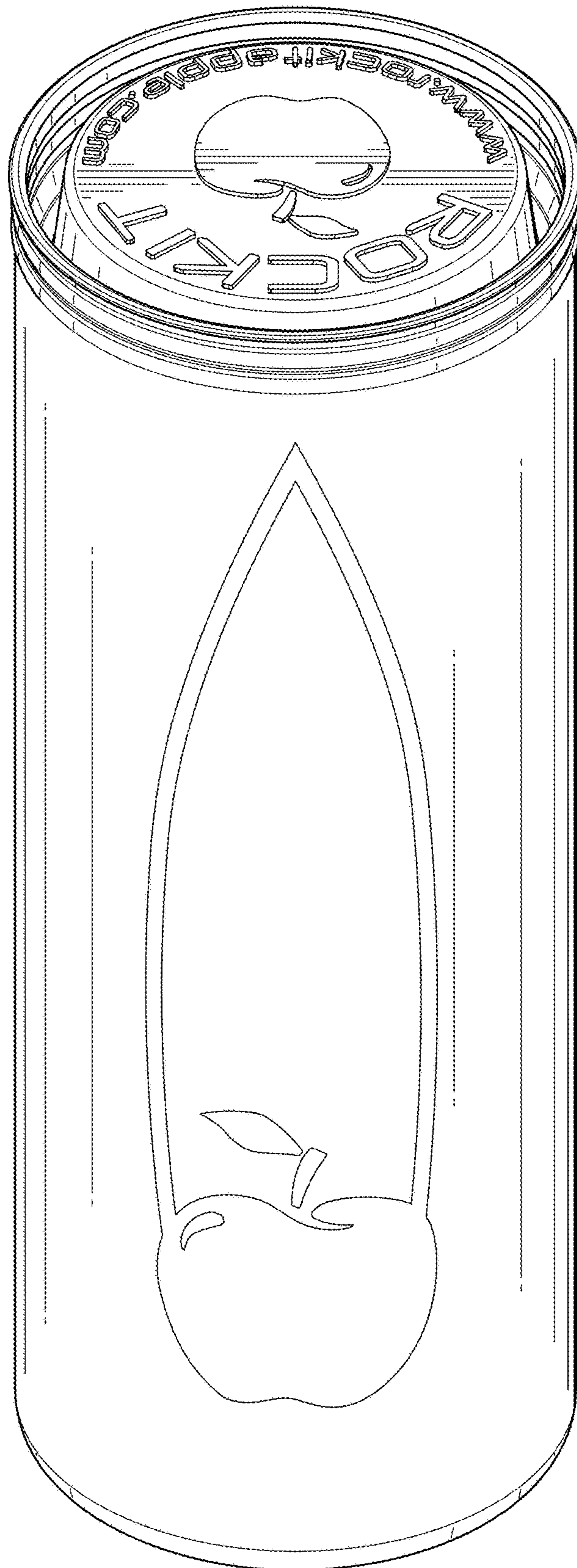

FIG. 8

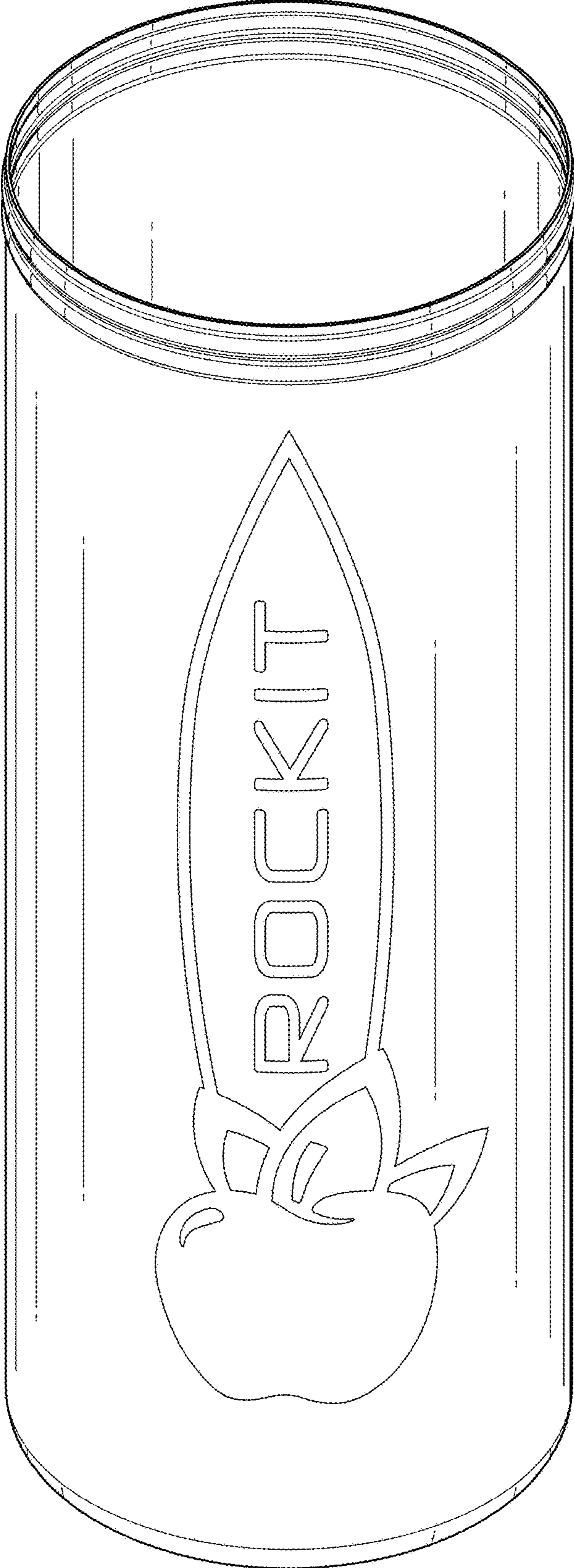

FIG. 9

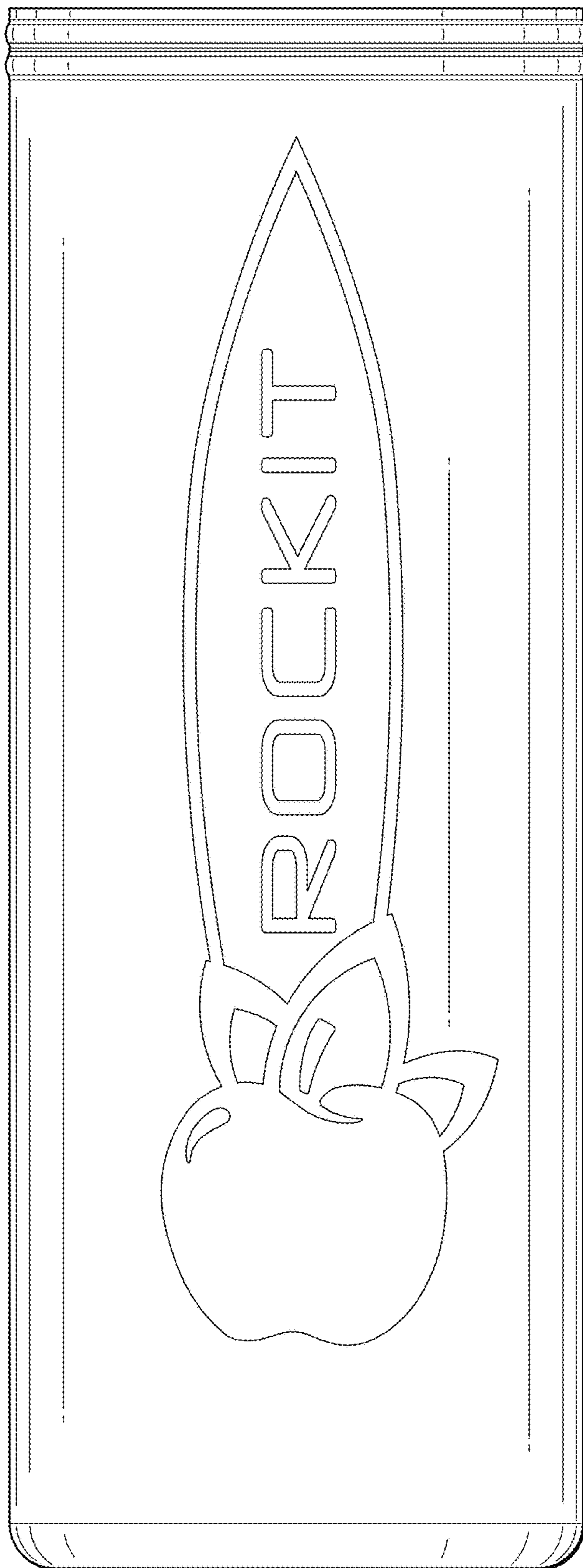

FIG. 10

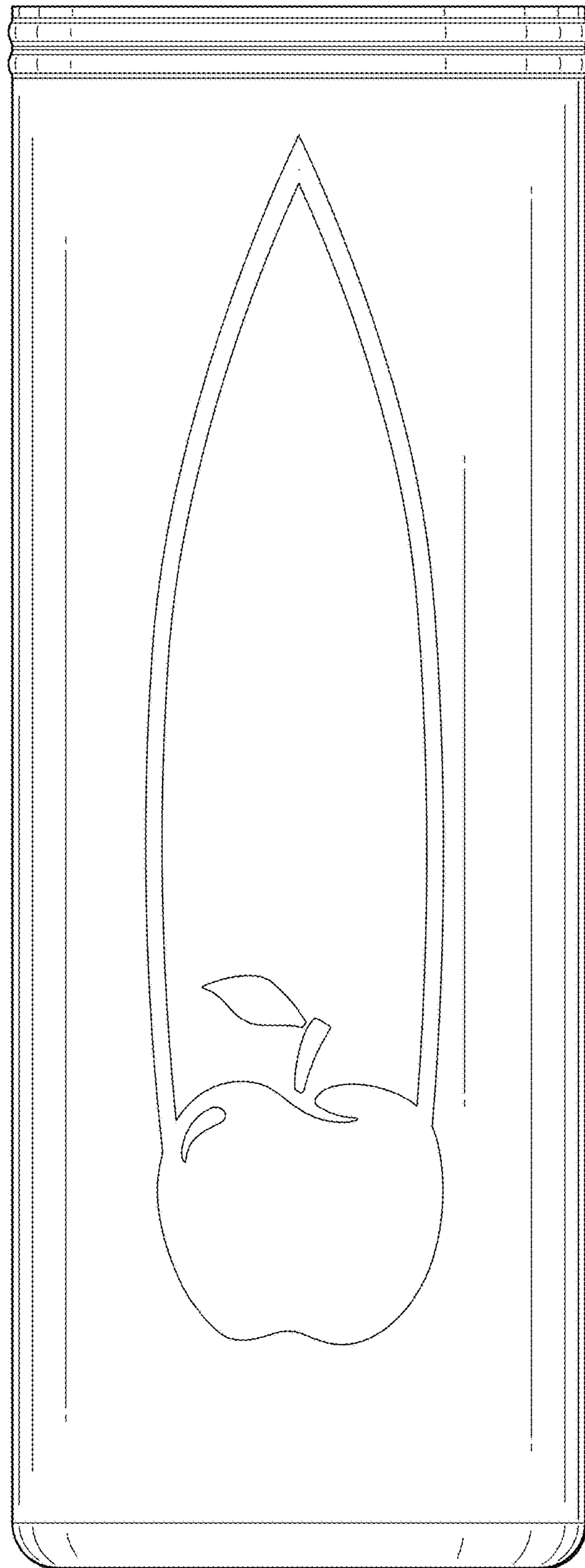

FIG. 11

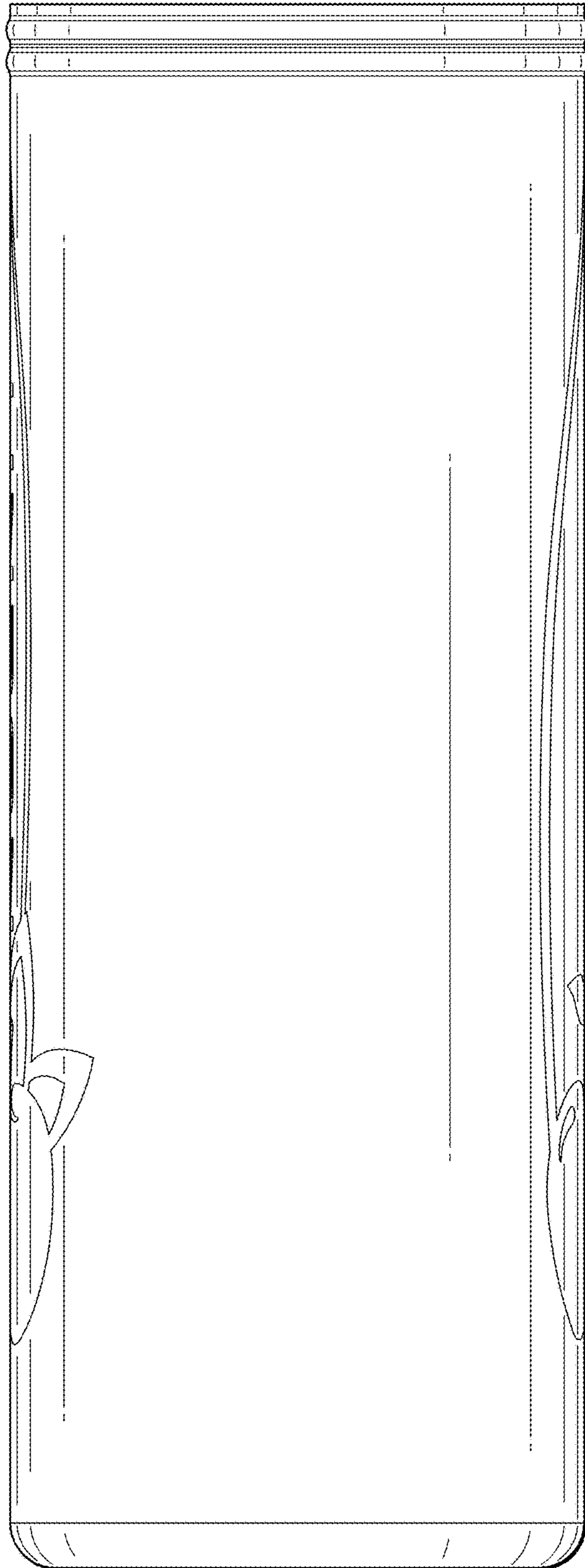

FIG. 12

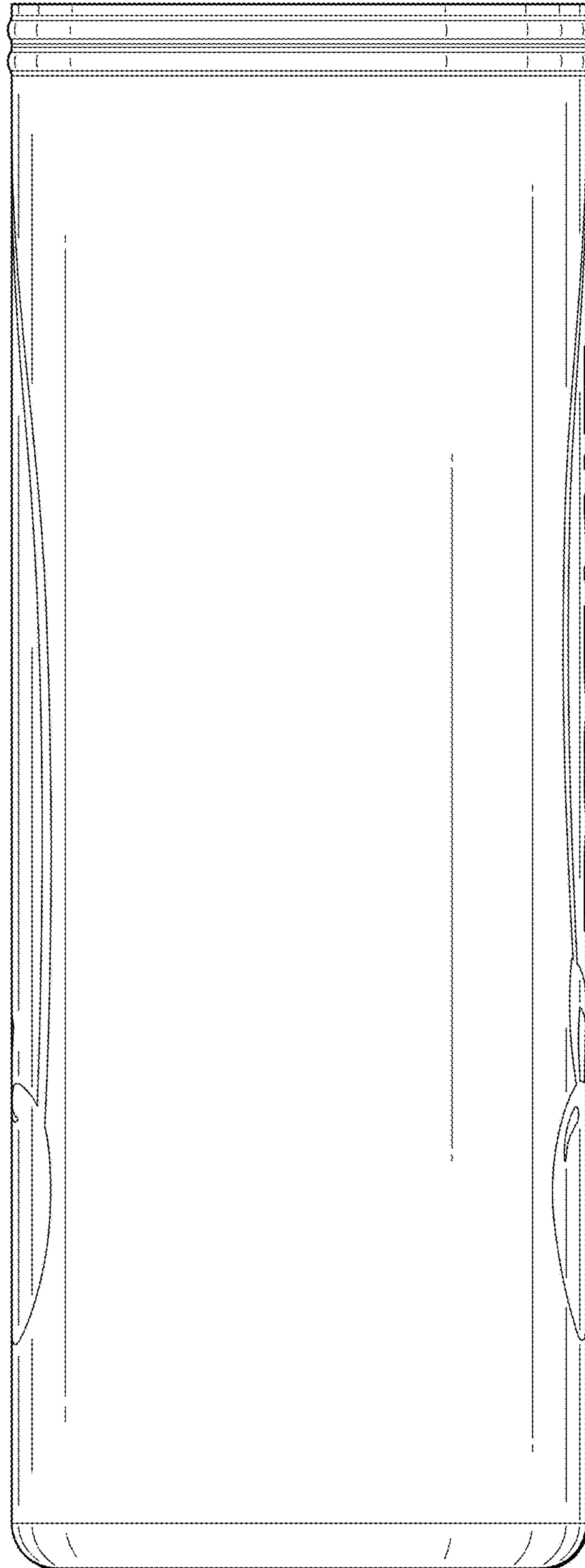

FIG. 13

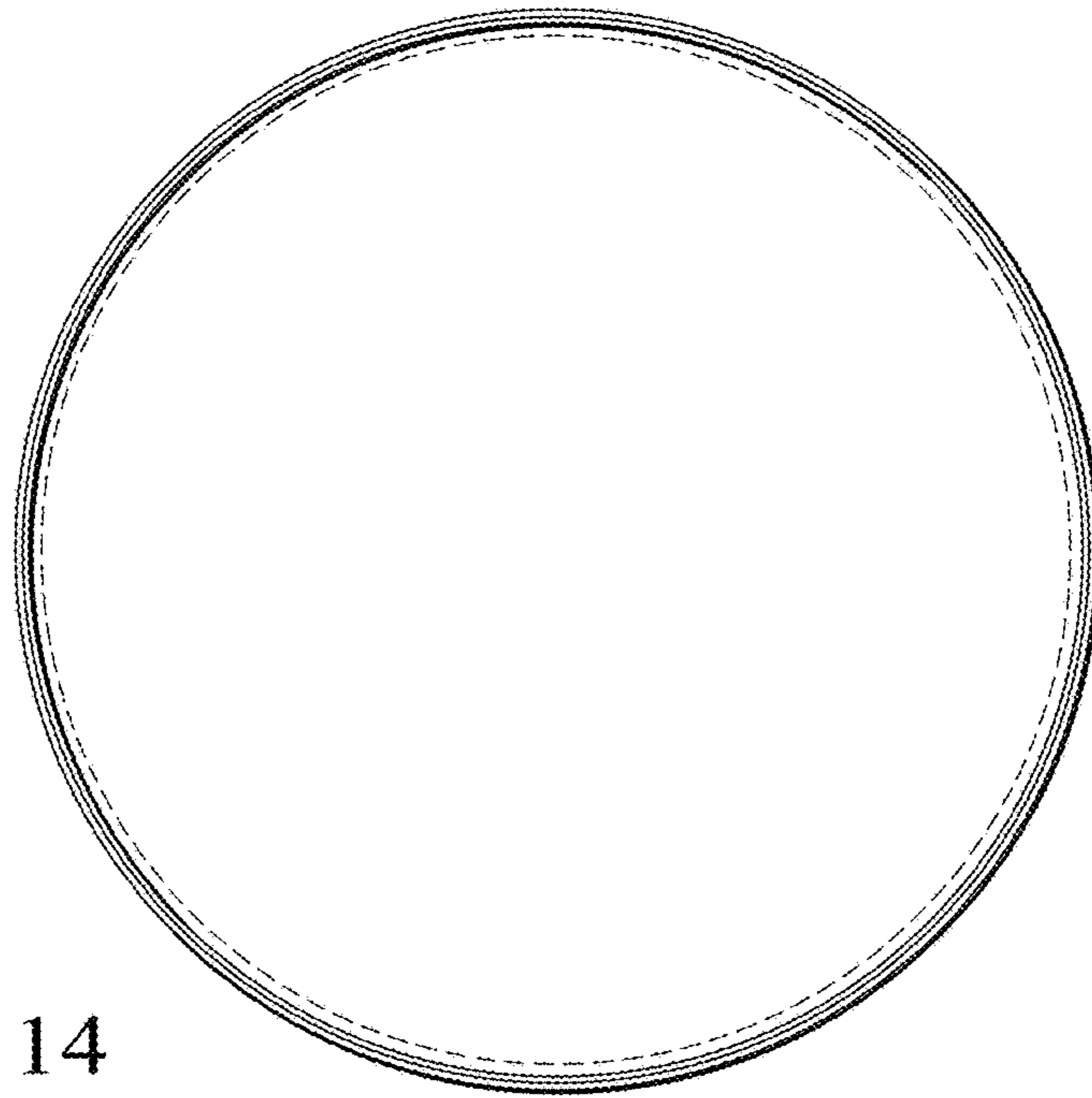

FIG. 14

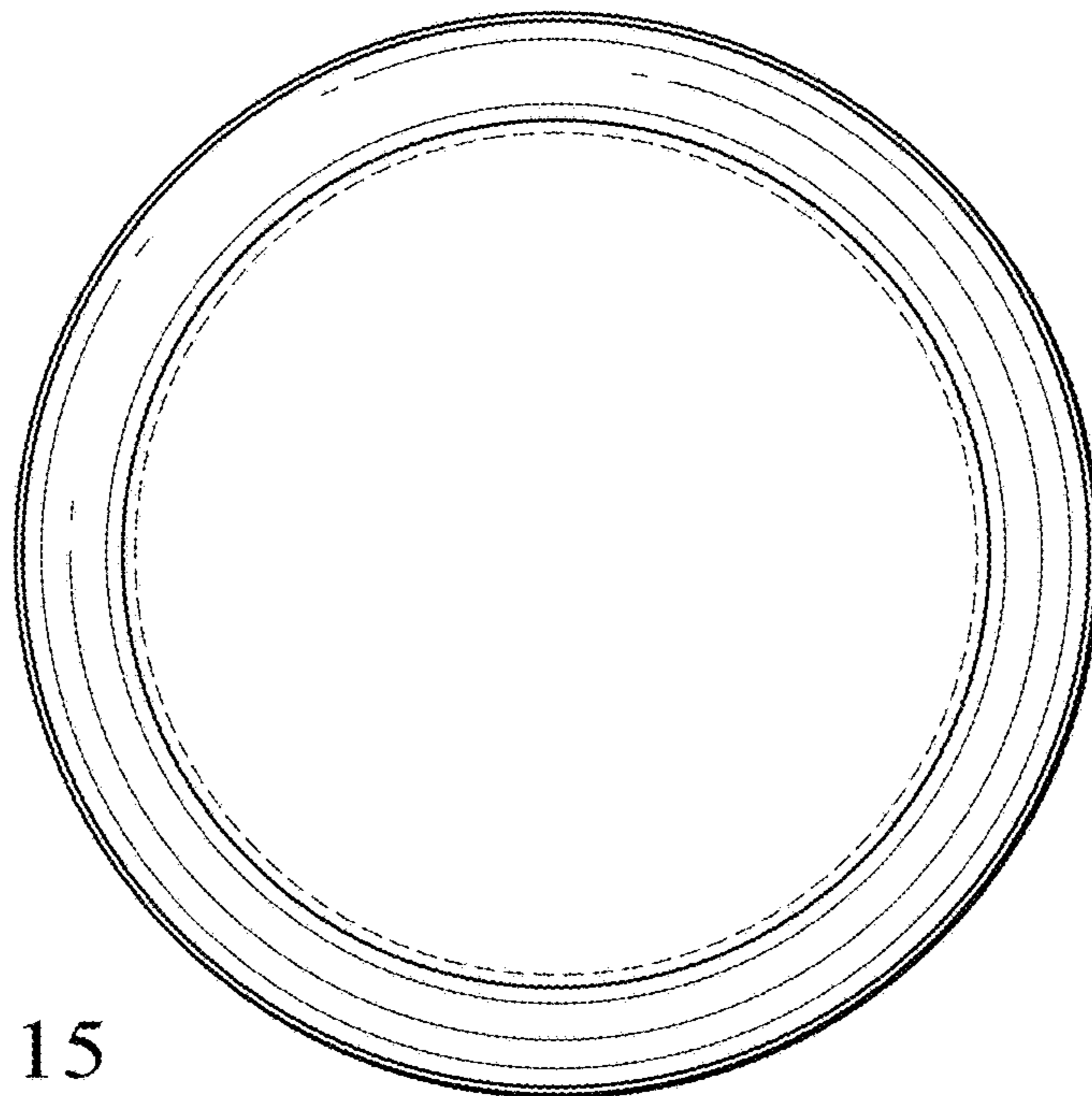

FIG. 15

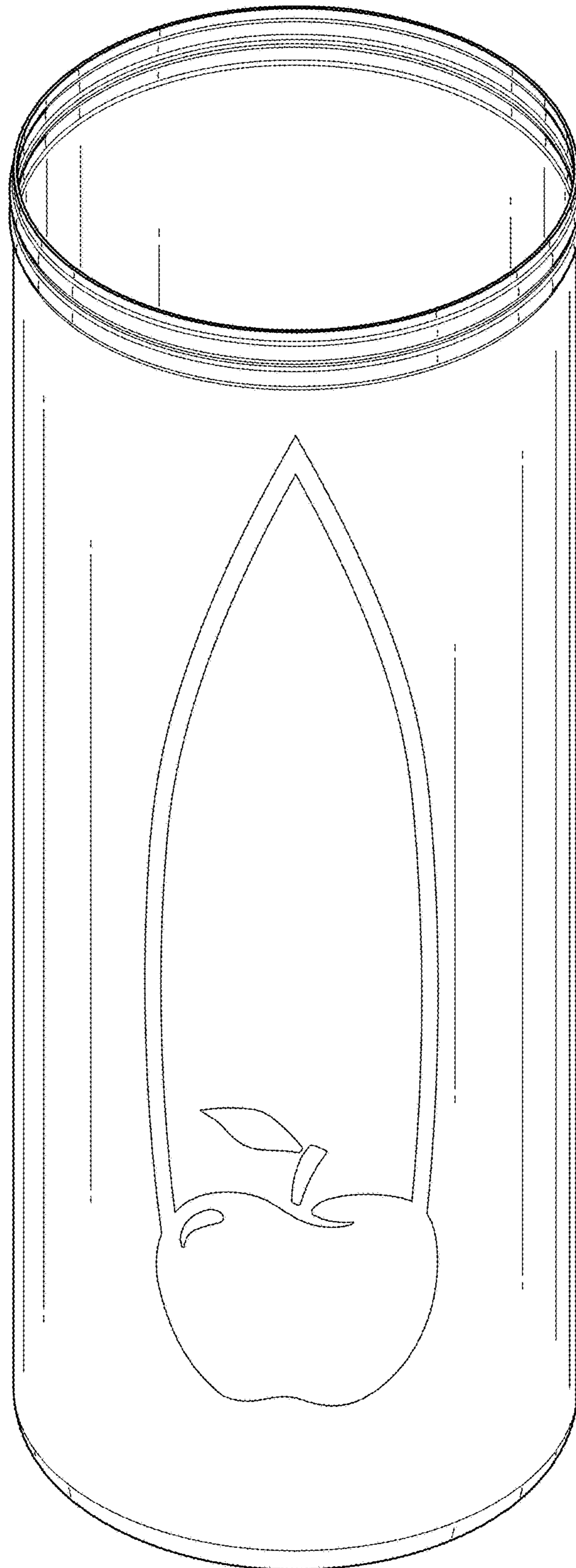

FIG. 16

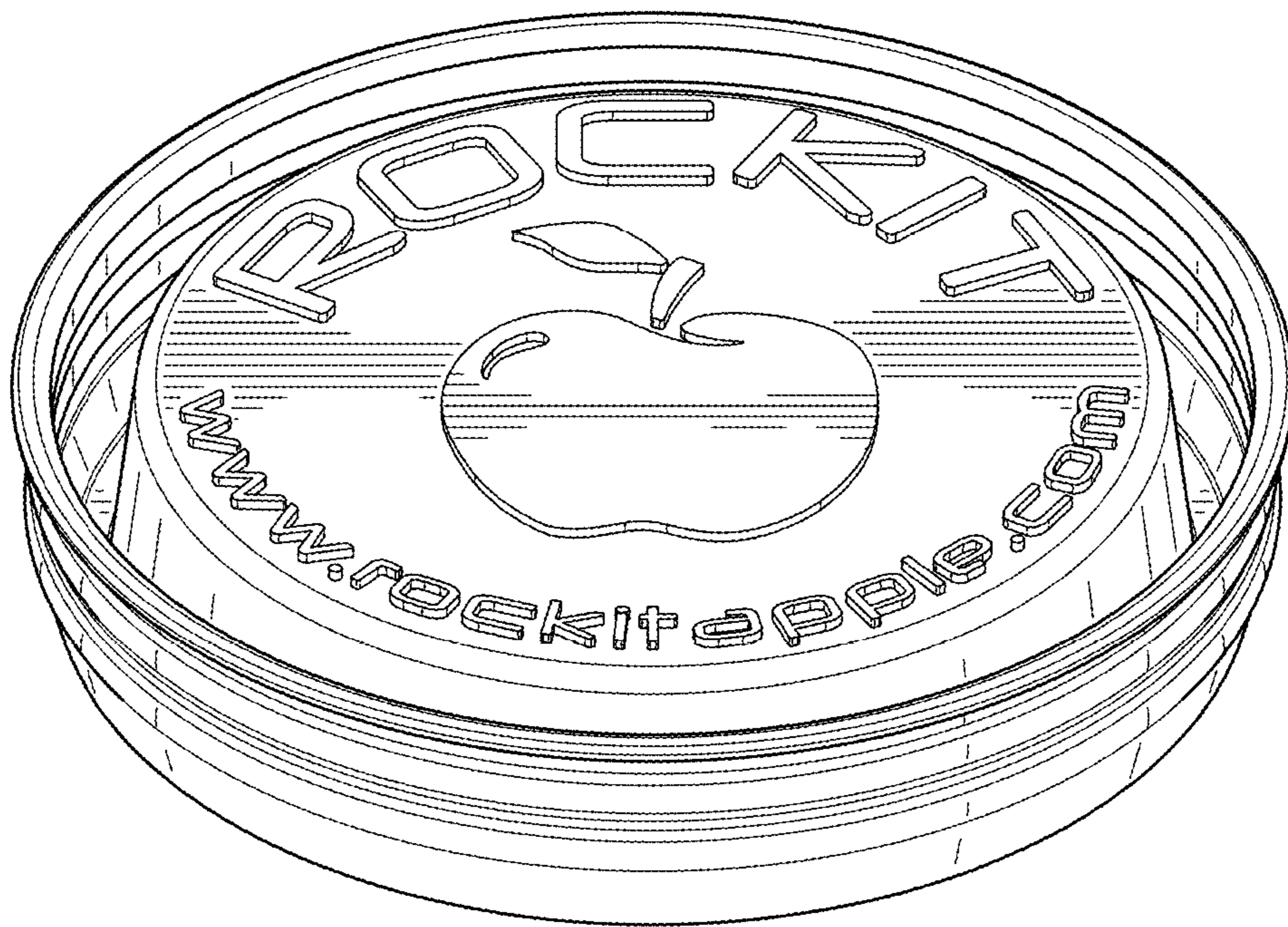

FIG. 17

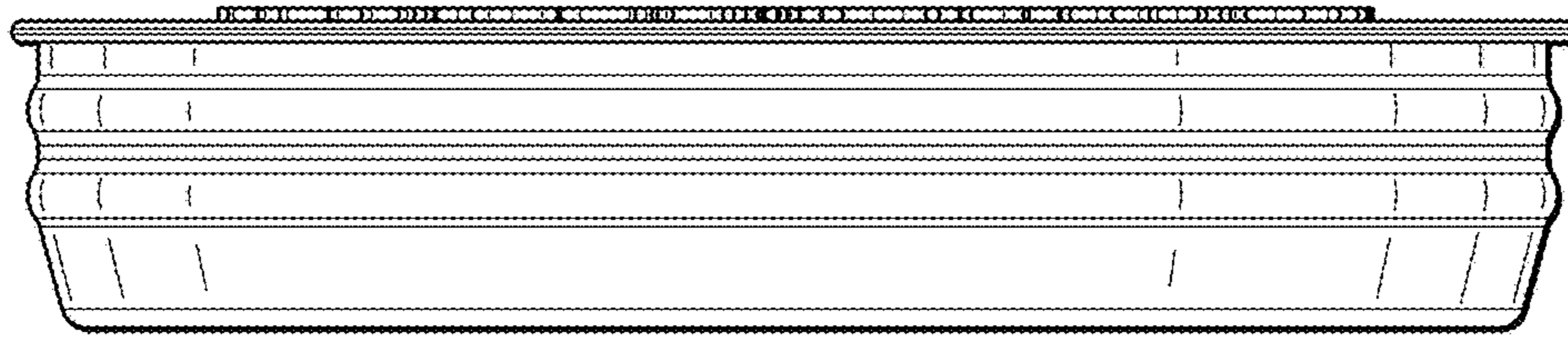

FIG. 18

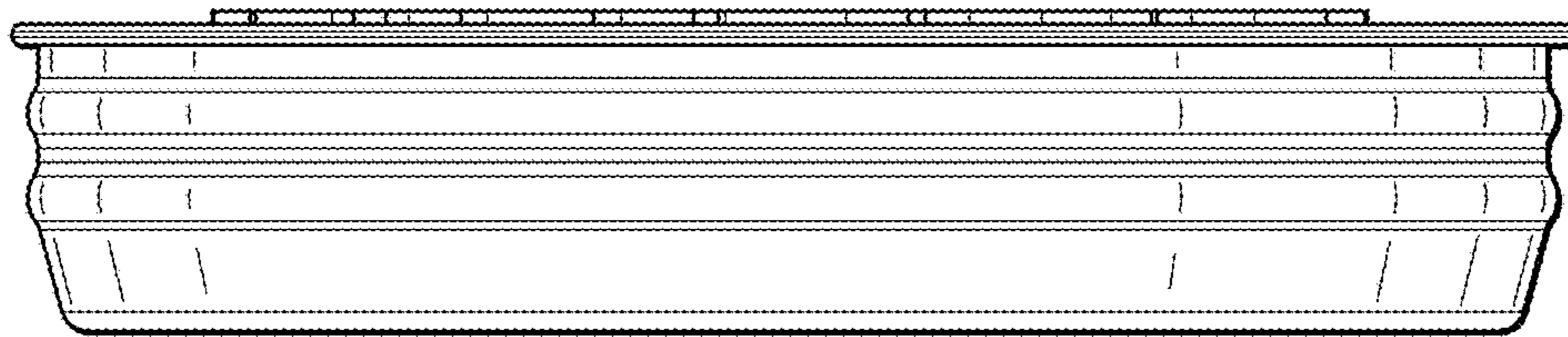

FIG. 19

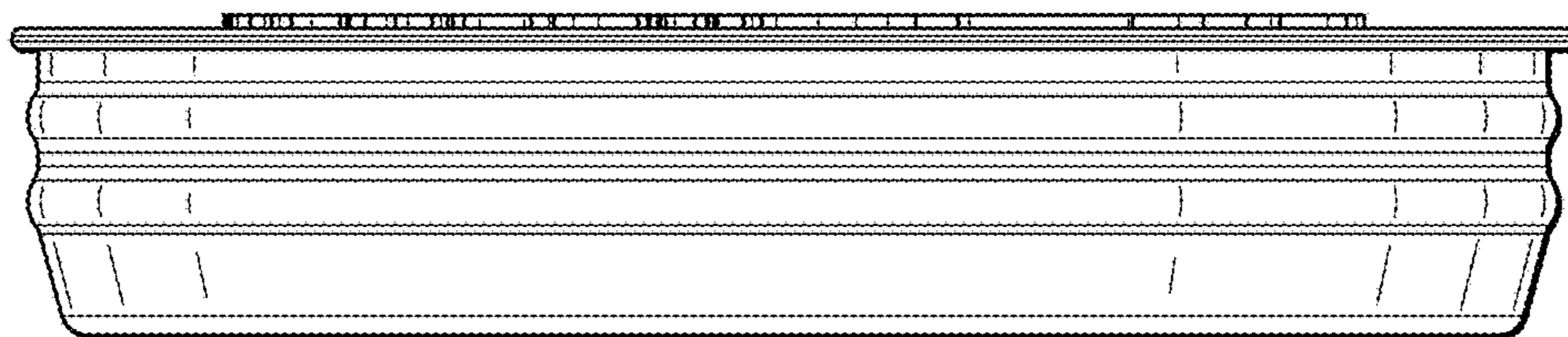

FIG. 20

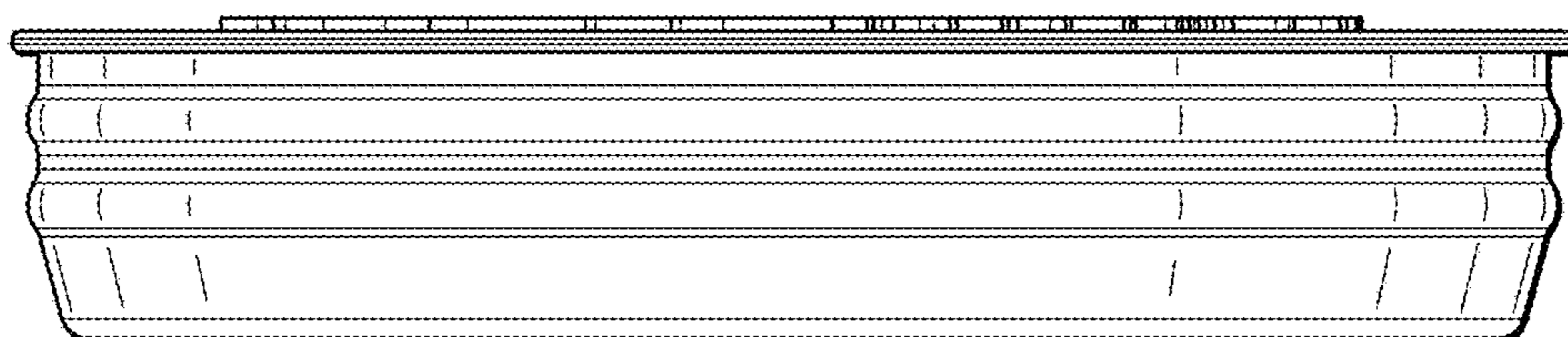

FIG. 21



FIG. 22

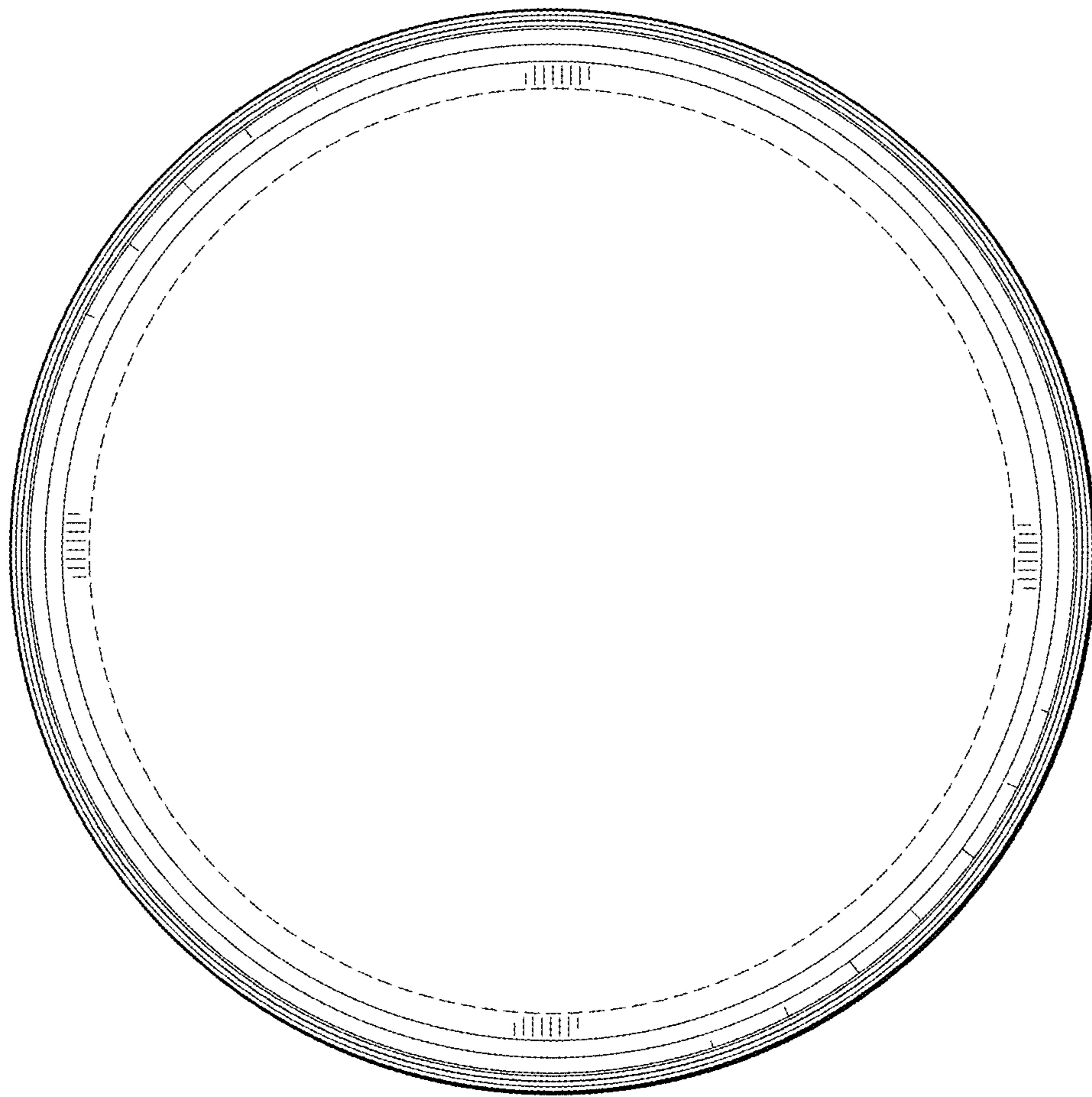

FIG. 23