



US00D822487S

(12) **United States Design Patent**
Luther

(10) **Patent No.:** **US D822,487 S**
(45) **Date of Patent:** **** Jul. 10, 2018**

- (54) **BOTTLE CAP HAT**
- (71) Applicant: **Stephen John Luther**, Terryville, CT (US)
- (72) Inventor: **Stephen John Luther**, Terryville, CT (US)
- (**) Term: **15 Years**
- (21) Appl. No.: **29/607,931**
- (22) Filed: **Jun. 16, 2017**
- (51) **LOC (11) Cl.** **09-07**
- (52) **U.S. Cl.**
USPC **D9/451**
- (58) **Field of Classification Search**
USPC D7/514-517, 519-520, 539, 604, 613, D7/619.2, 623, 628, 392.1; D9/600-601, D9/614-619, 632, 434, 436, 441, D9/444-454; 206/494, 457, 459.1, 459.2; 220/890; 215/206, 260, 387-400; D2/869-874, 885-888; D11/121, 128, D11/158-160; D21/631, 633, 639-640
CPC B65D 67/00; B65D 81/36; B65D 81/365; B65D 81/366; B65D 81/368; B65D 41/00; B65D 41/02; B65D 51/245; A63H 33/16
See application file for complete search history.

- D440,744 S * 4/2001 Shu D2/886
- D464,157 S * 10/2002 Kumar D26/11
- D612,762 S * 3/2010 Garrison D11/128
- D673,420 S * 1/2013 Imo D7/392.1
- D727,151 S * 4/2015 Leitch D2/889

* cited by examiner

Primary Examiner — Sandra L Morris
(74) *Attorney, Agent, or Firm* — Ingenium Patents LLC; Peter R. Kramer

(56) **References Cited**
U.S. PATENT DOCUMENTS

- D181,971 S * 1/1958 Goldstein D9/632
- D231,957 S * 7/1974 Veltri D2/869

(57) **CLAIM**

The ornamental design for an ornamental bottle cap hat, as shown and described.

DESCRIPTION

FIG. 1 is a front view of the bottle cap hat showing my new design, the broken line showing of the bottle is for illustrative purposes only, and forms no part of the claimed design
FIG. 2 Back view
FIG. 3 Right view
FIG. 4 Left view
FIG. 5 Bottom view
FIG. 6 is a top perspective view
FIG. 7 is a bottom perspective view; and,
FIG. 8 Top view.
An ornamental bottle cap hat as shown in the accompanying drawings. The environment shown in FIG. 1 is a bottle.

1 Claim, 8 Drawing Sheets

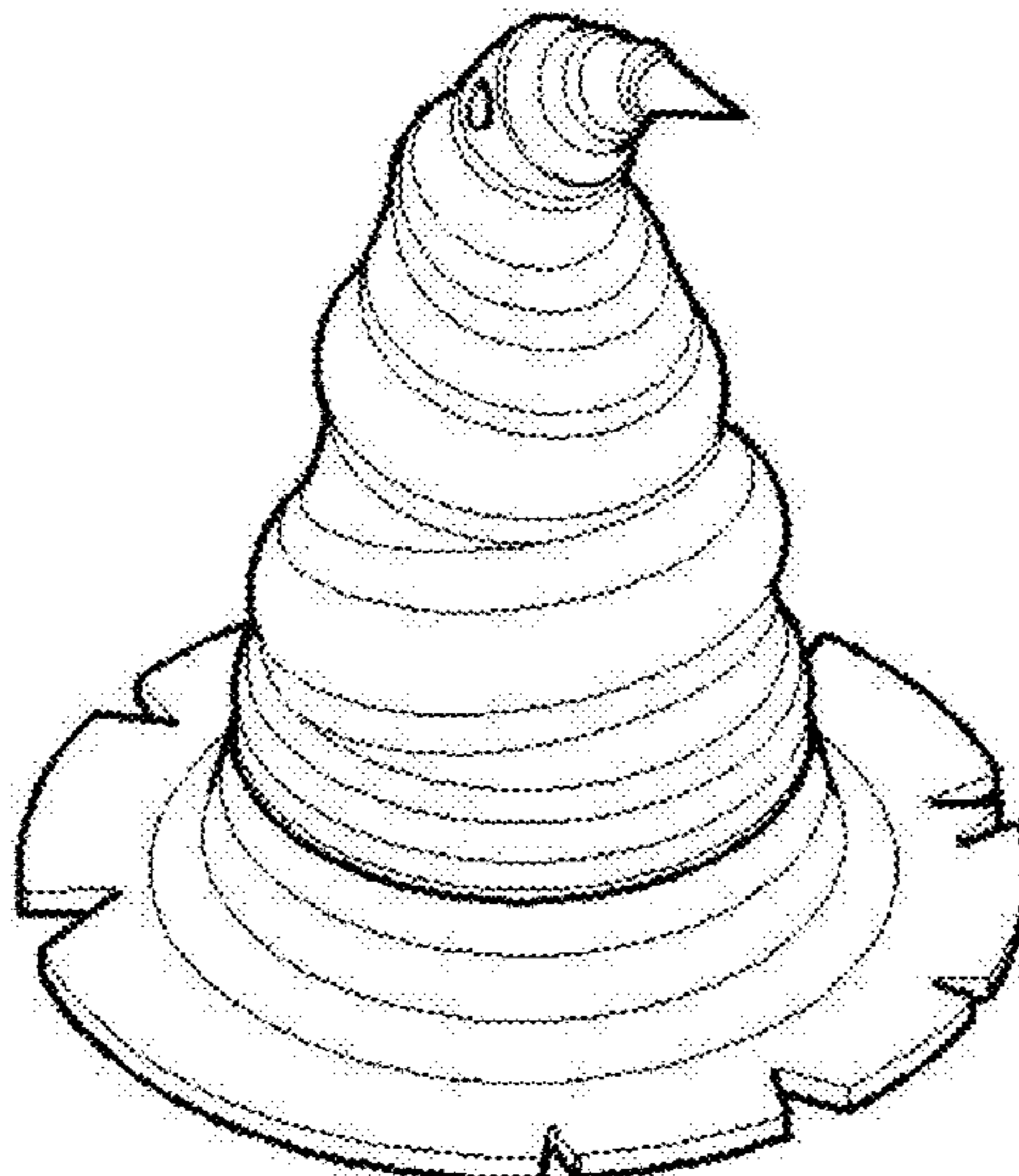

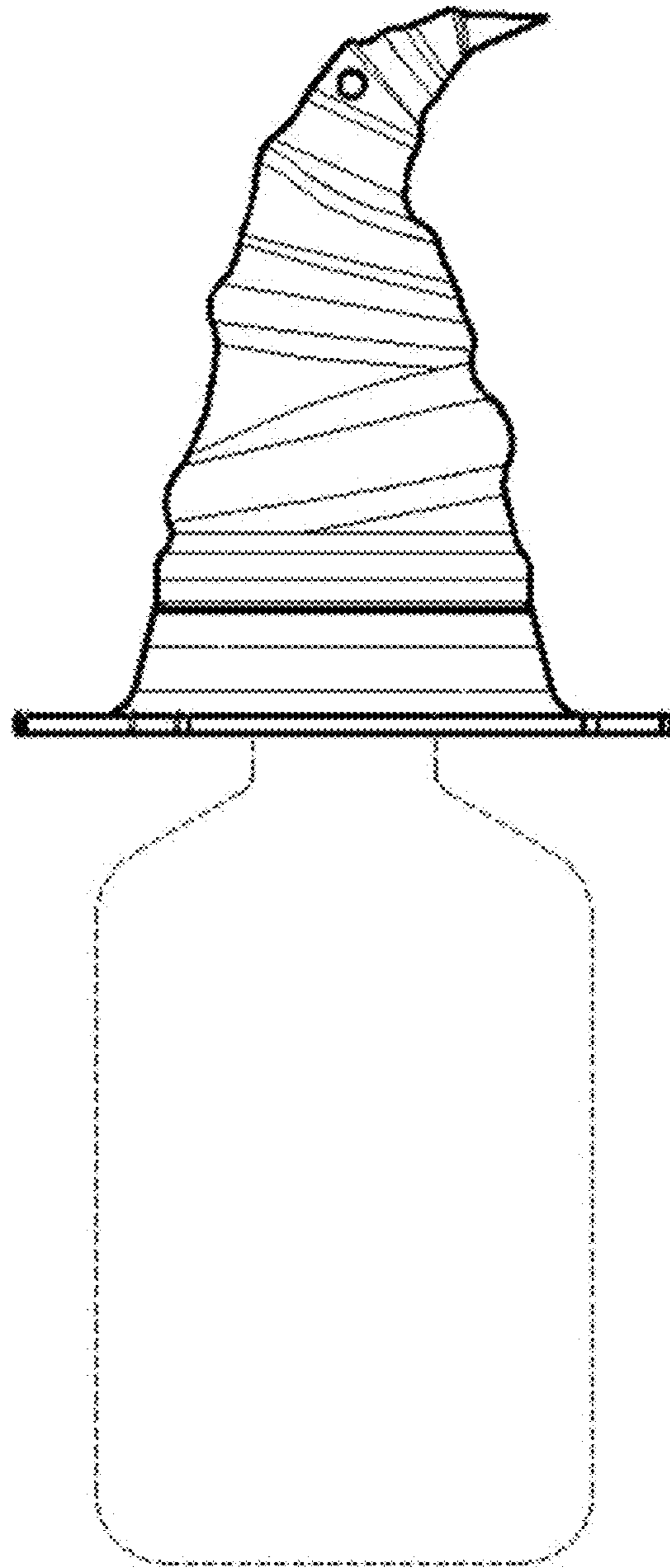

FIG. 1

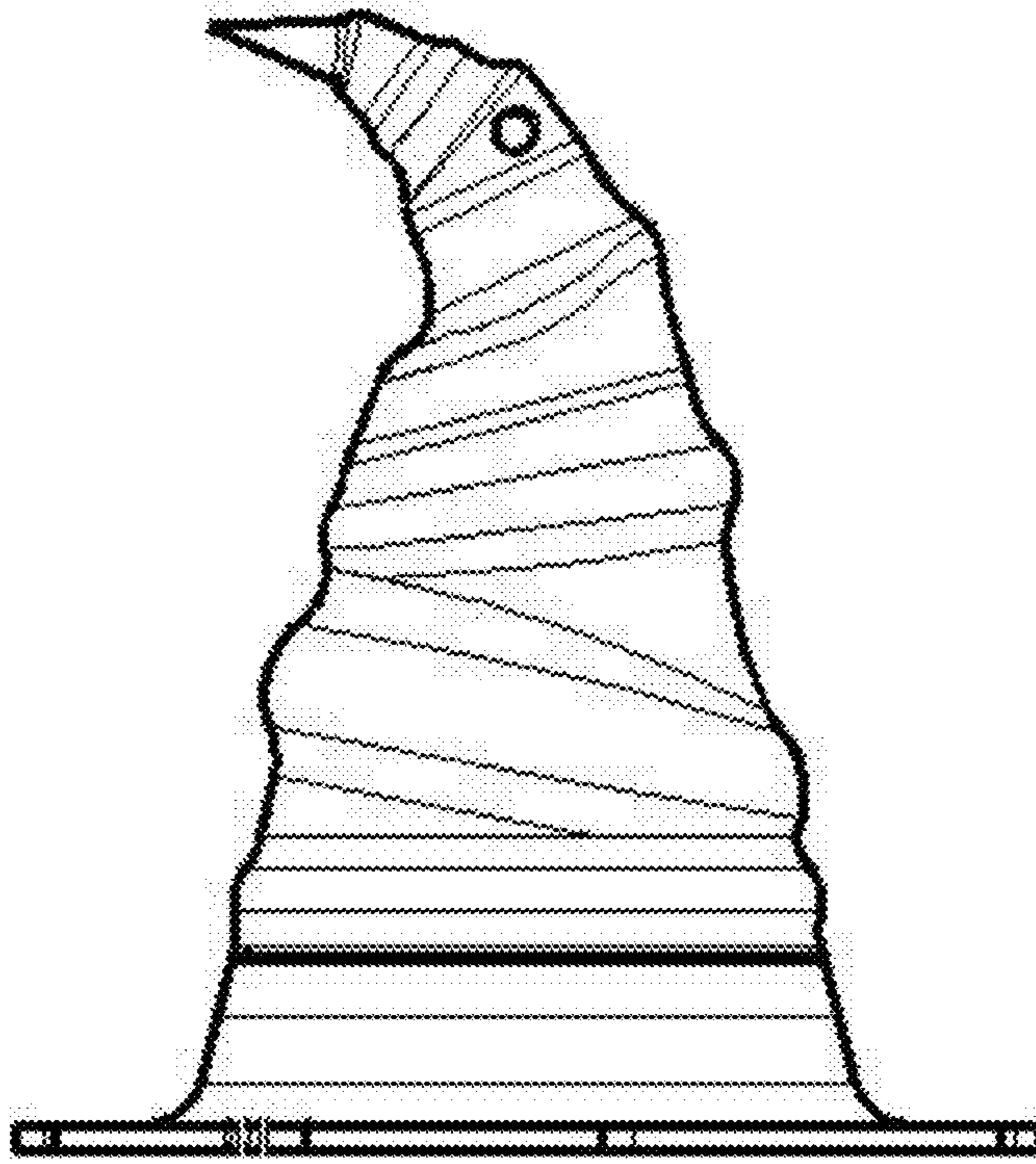

FIG. 2

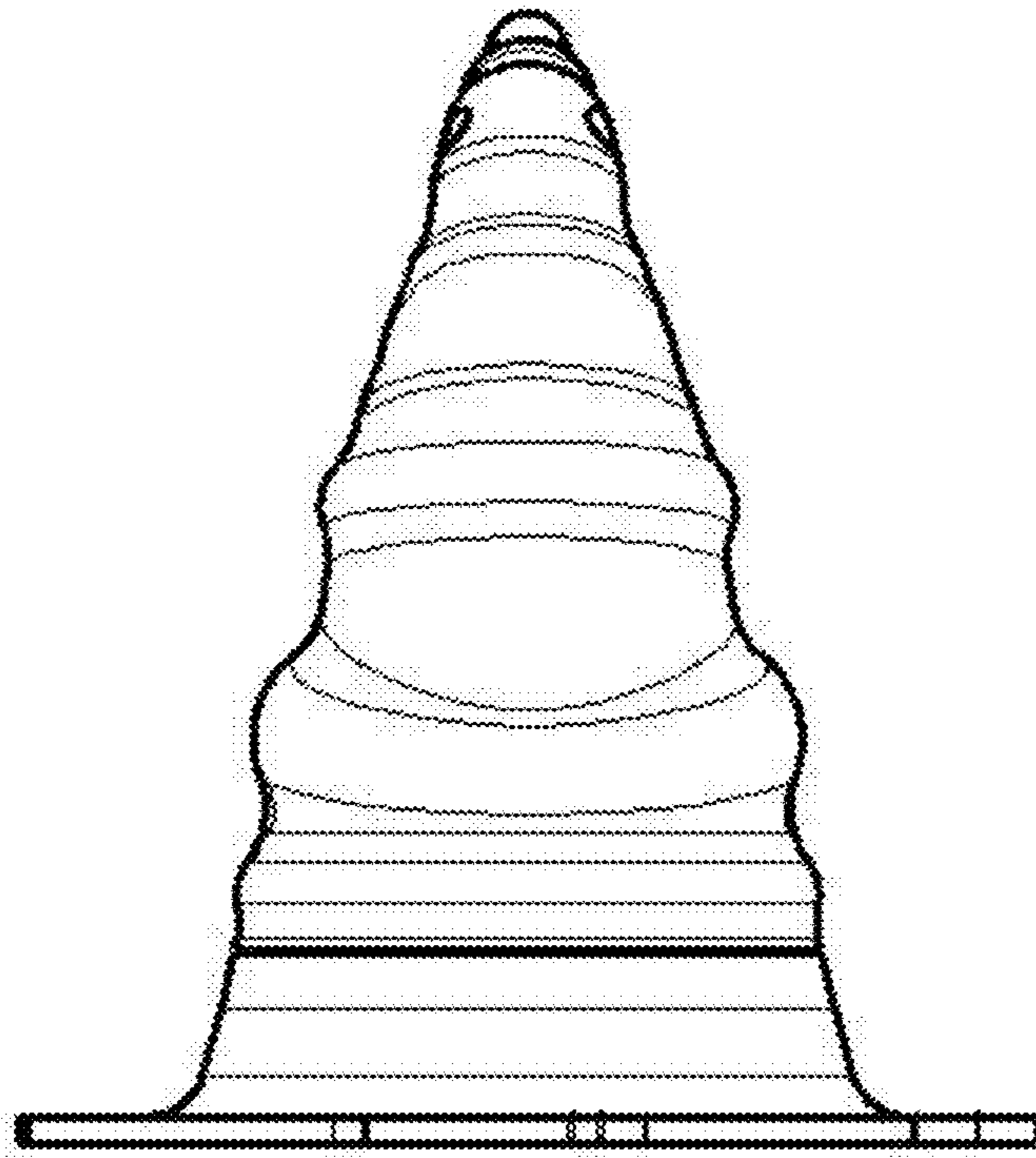

FIG. 3

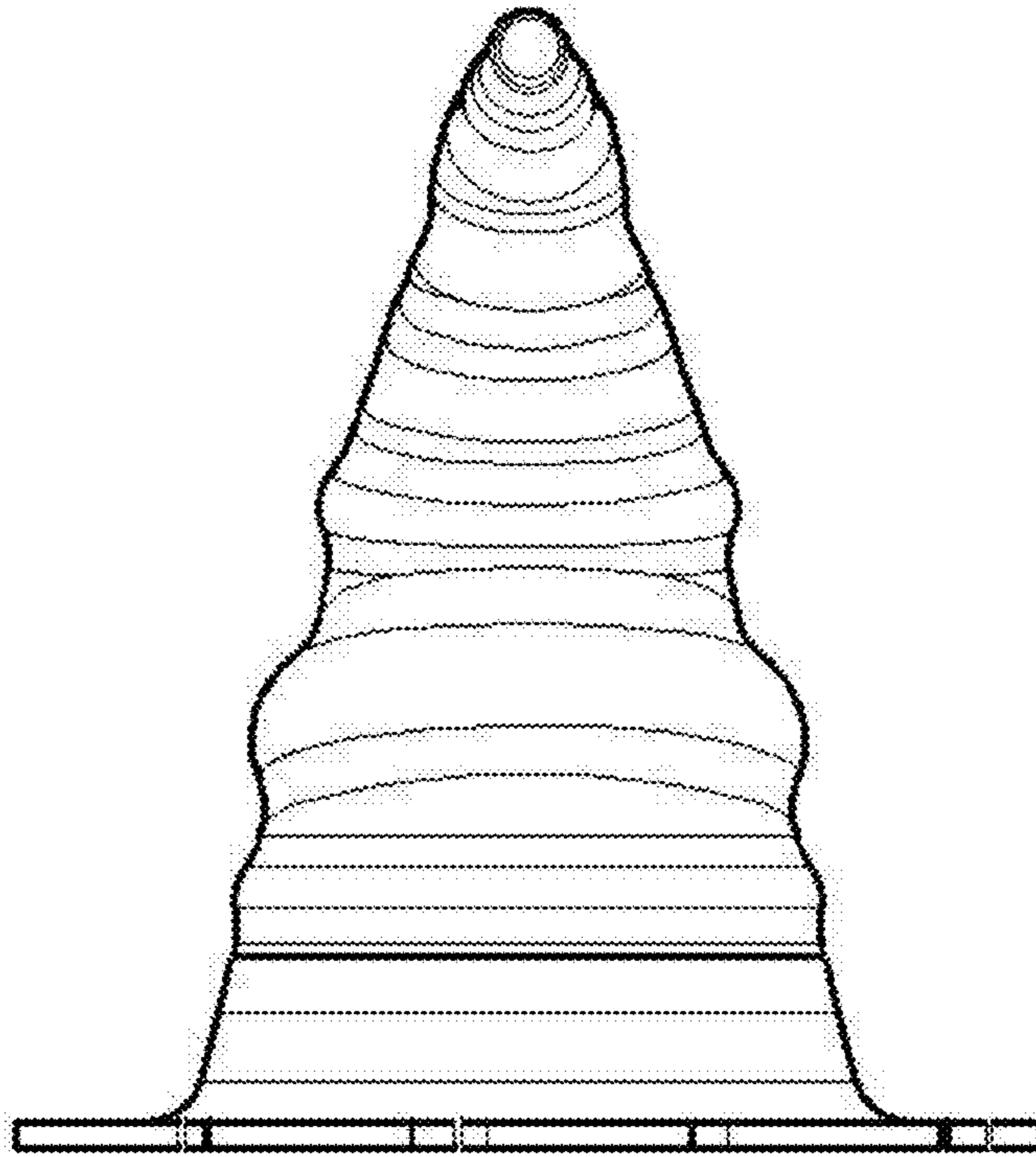

FIG. 4

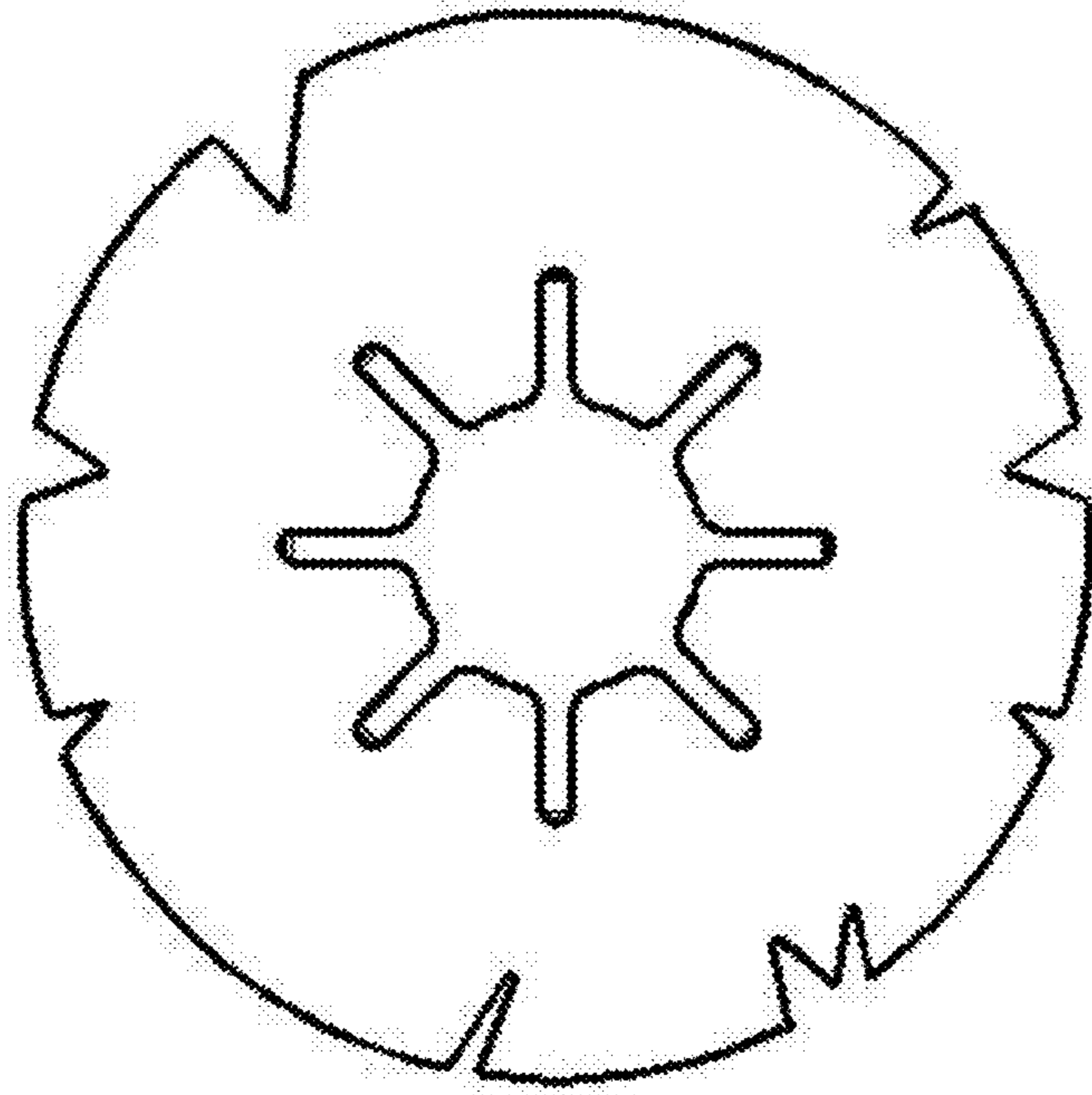

FIG. 5

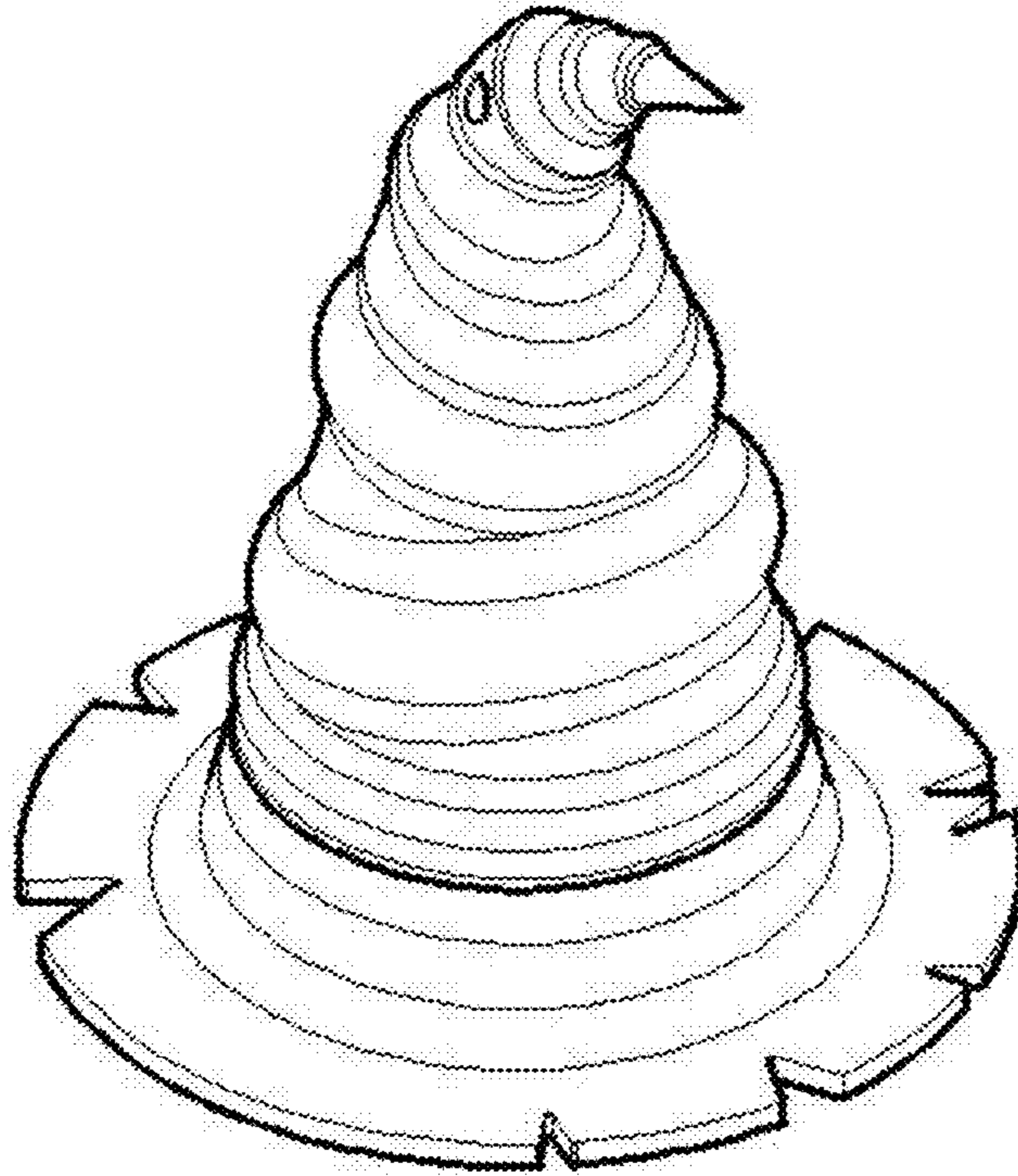

FIG. 6

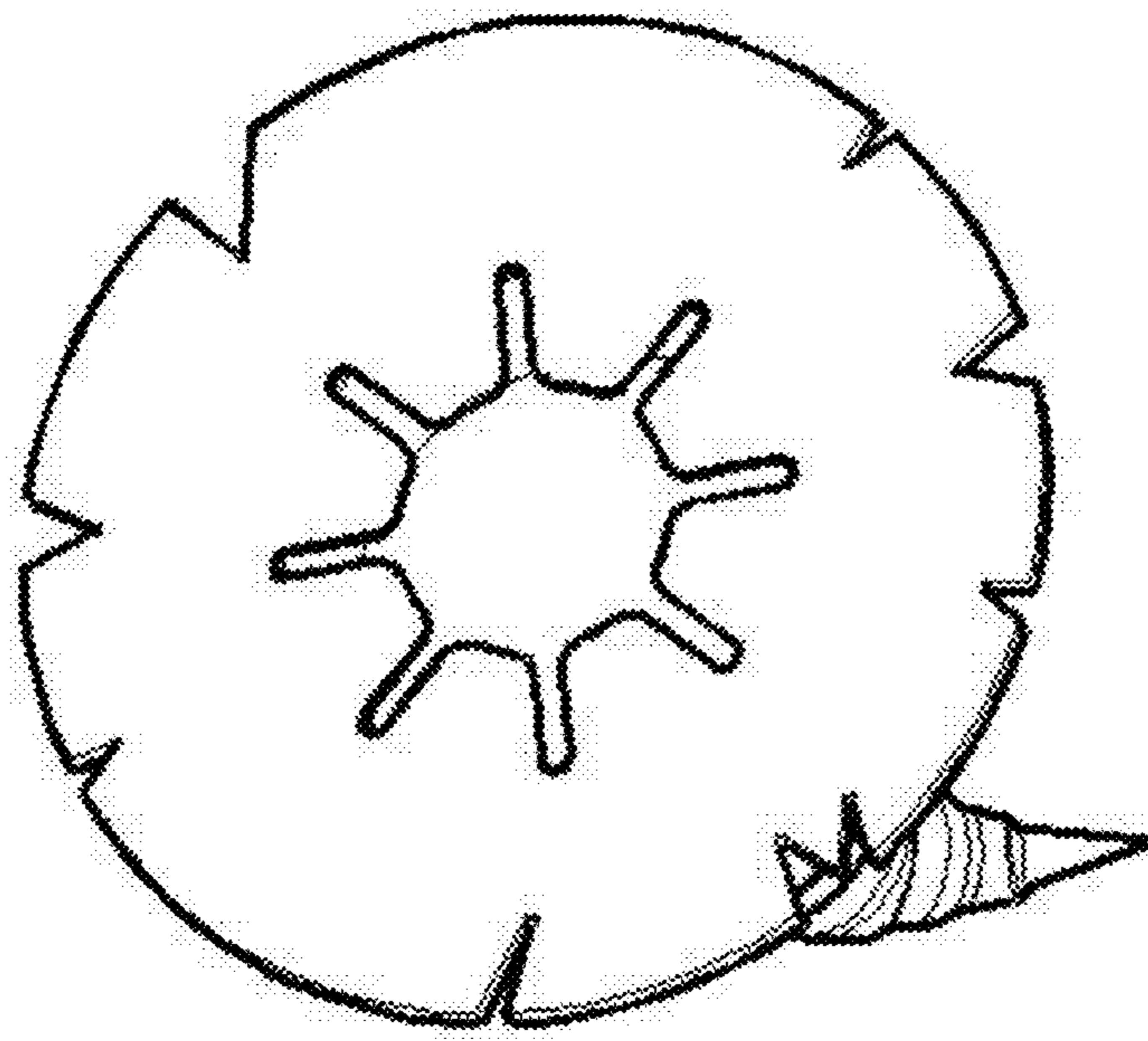

FIG. 7

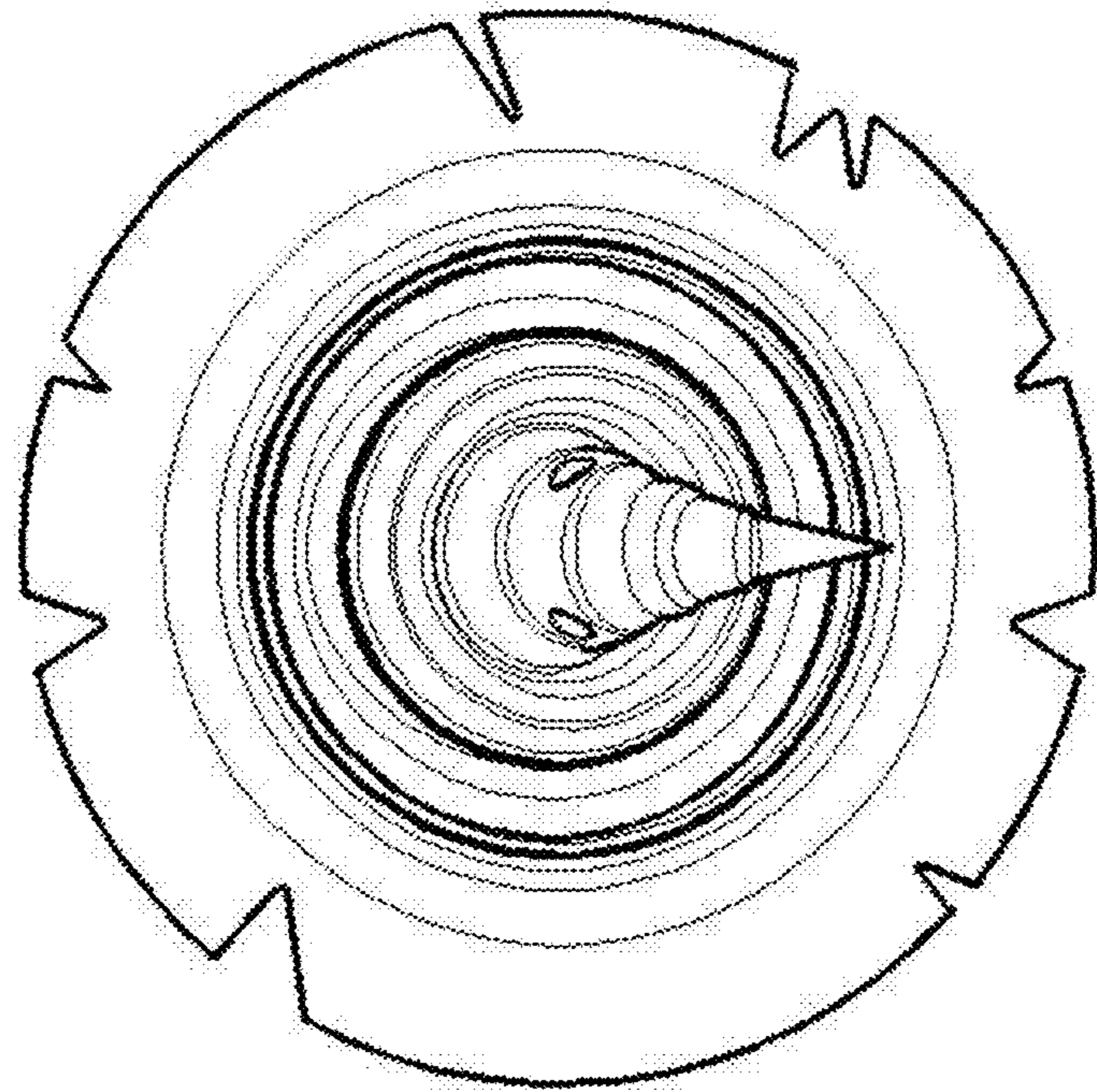

FIG. 8