



US00D822345S

(12) **United States Design Patent**
Swersky

(10) **Patent No.:** **US D822,345 S**
(45) **Date of Patent:** **** Jul. 10, 2018**

- (54) **ONE-LEGGED LEGGINGS**
- (71) Applicant: **Debra Swersky**, Dallas, TX (US)
- (72) Inventor: **Debra Swersky**, Dallas, TX (US)
- (**) Term: **15 Years**
- (21) Appl. No.: **29/604,944**
- (22) Filed: **May 22, 2017**
- (51) **LOC (11) Cl.** **02-02**
- (52) **U.S. Cl.**
USPC **D2/731; D2/742**
- (58) **Field of Classification Search**
USPC D2/731, 742, 747, 700, 718; 2/220, 242
CPC A41D 7/00; A41D 7/001; A41D 7/005;
A41D 7/006; A41D 1/00; A41D 1/06;
A41D 13/1254; A41D 13/1236
See application file for complete search history.

(56) **References Cited**

U.S. PATENT DOCUMENTS

- 3,111,680 A * 11/1963 Horowitz A41D 1/06
2/227
- D461,943 S * 8/2002 Lyden D2/742
- D466,676 S * 12/2002 Lyden D2/742
- 6,487,727 B1 * 12/2002 Harsant A41D 10/00
2/400
- D622,935 S * 9/2010 Jackson D2/742
- D683,522 S * 6/2013 Pasloski D2/731
- D758,695 S * 6/2016 Lago D2/742
- D783,939 S * 4/2017 Scott D2/742
- D786,534 S * 5/2017 Alligood D2/731
- 2015/0143855 A1 * 5/2015 Nygard A41D 1/06
66/177
- 2015/0201685 A1 * 7/2015 Brohmer A41D 13/065
2/23

- 2015/0237932 A1 * 8/2015 Carryl A41D 13/1254
2/69
- 2017/0311662 A1 * 11/2017 Pina A41D 13/1254
- 2017/0325526 A1 * 11/2017 Barnabe A41D 27/00

* cited by examiner

Primary Examiner — Robin Valery Webster
Assistant Examiner — James C. Thorn, Sr.
(74) *Attorney, Agent, or Firm* — Quickpatents, LLC;
Kevin Prince

(57) **CLAIM**

I claim the ornamental design for one-legged leggings, as shown and described.

DESCRIPTION

FIG. 1 is a perspective view of one-legged leggings, showing a first embodiment of my new design;
FIG. 2 is a front elevational view of FIG. 1;
FIG. 3 is a rear elevational view of FIG. 1;
FIG. 4 is a left-side elevational view of FIG. 1;
FIG. 5 is a right-side elevational view of FIG. 1;
FIG. 6 is a top plan view of FIG. 1;
FIG. 7 is a bottom plan view of FIG. 1;
FIG. 8 is a perspective view of a second embodiment thereof;
FIG. 9 is a front elevational view of FIG. 8;
FIG. 10 is a rear elevational view of FIG. 8;
FIG. 11 is a left-side elevational view of FIG. 8;
FIG. 12 is a right-side elevational view of FIG. 8;
FIG. 13 is a top plan view of FIG. 8; and,
FIG. 14 is a bottom plan view of FIG. 8.
The broken lines in the figures represent stitching, and are part of the claimed design.

1 Claim, 10 Drawing Sheets

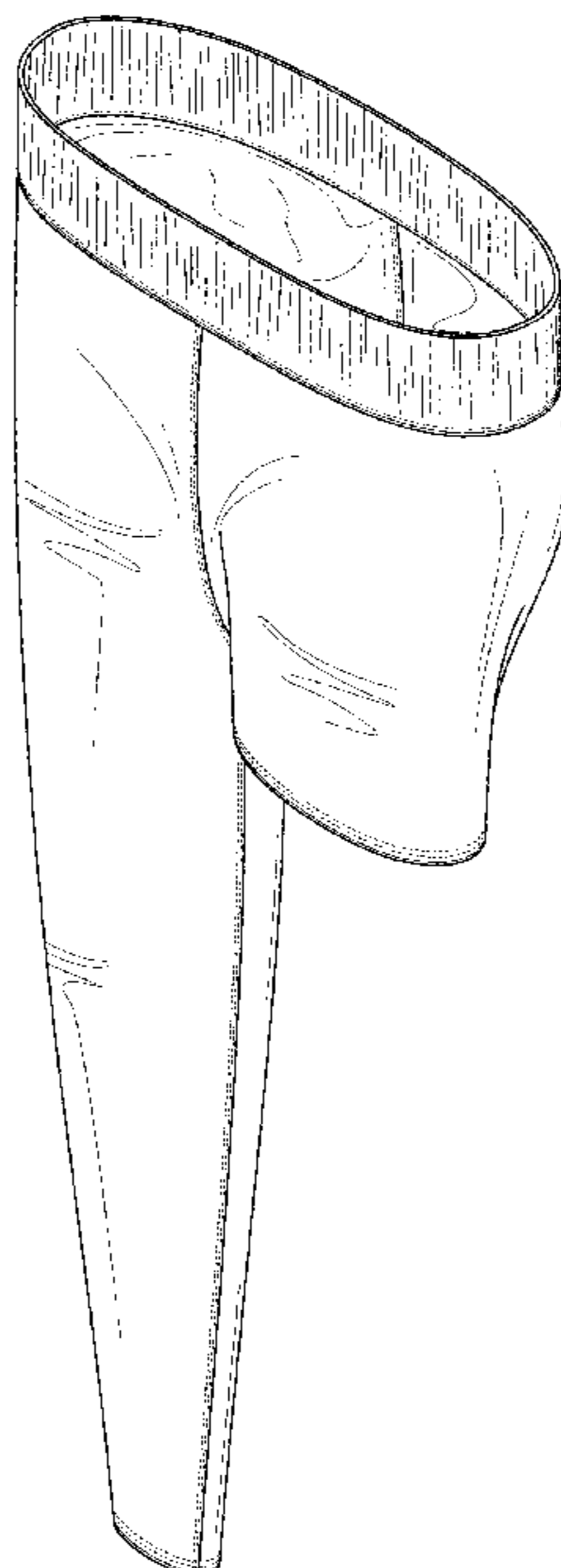

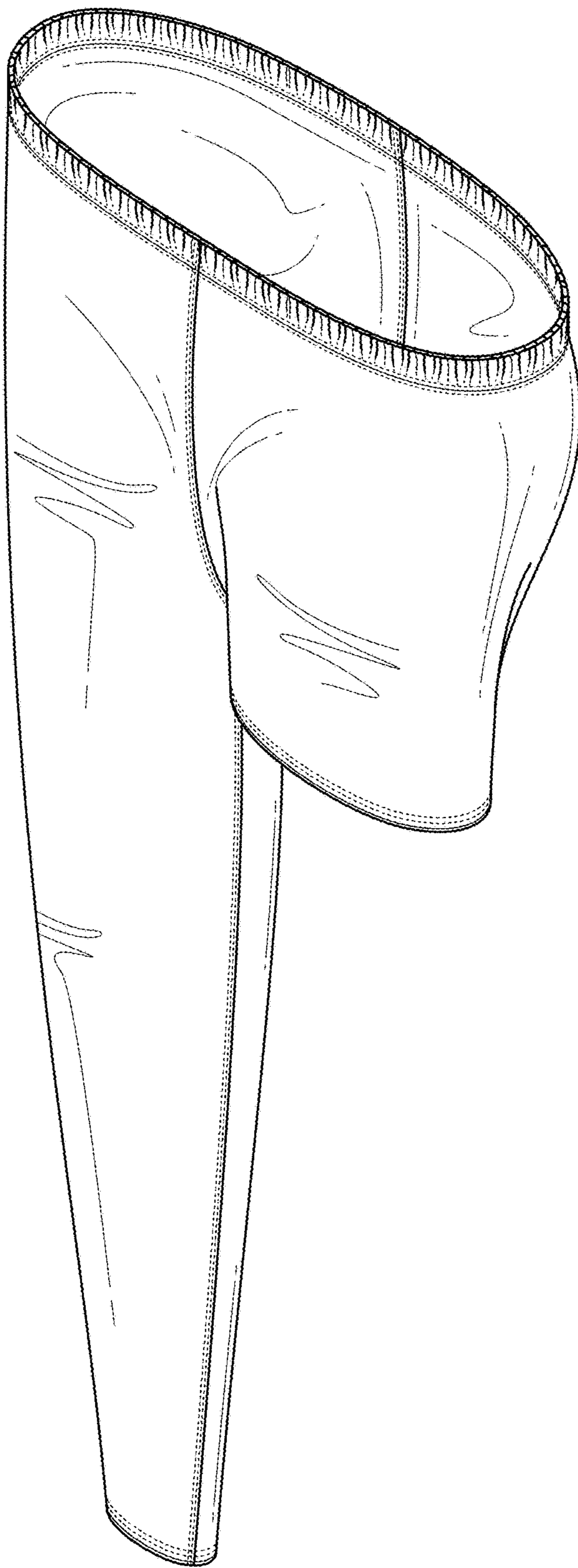

FIG. 1

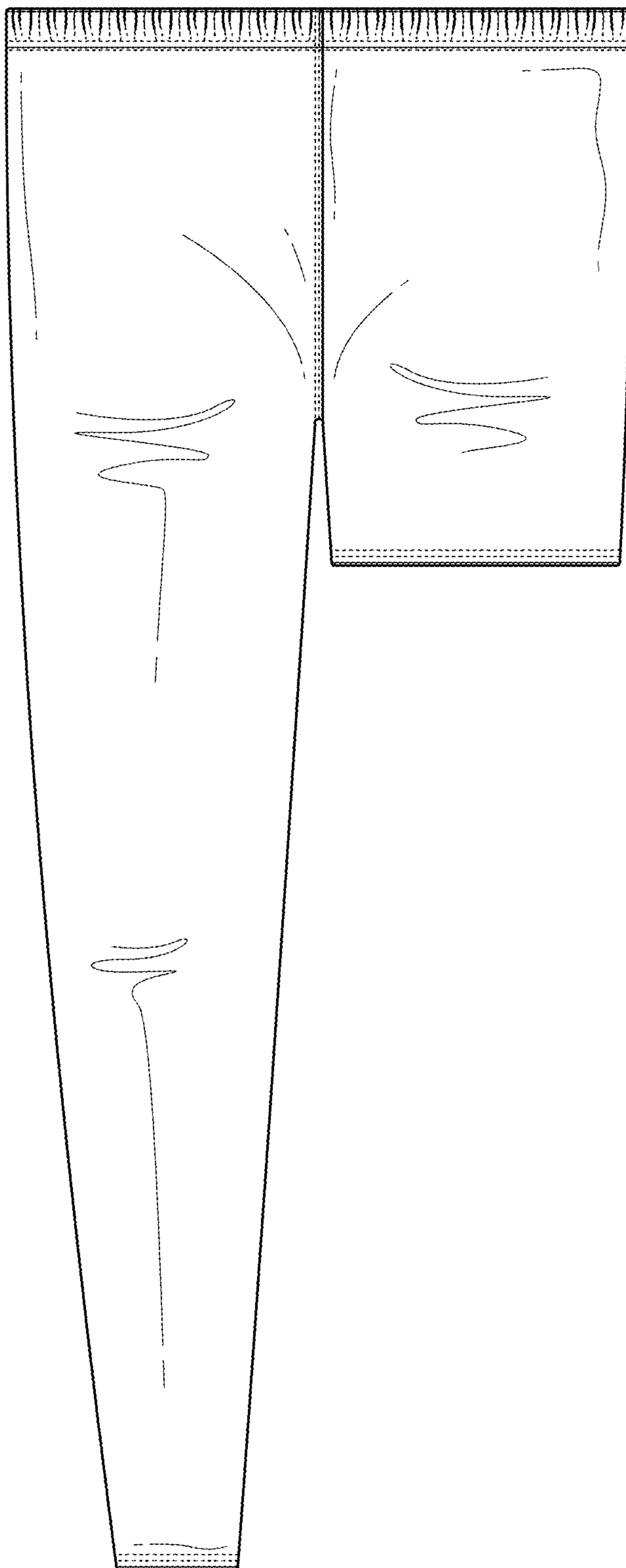

FIG. 2

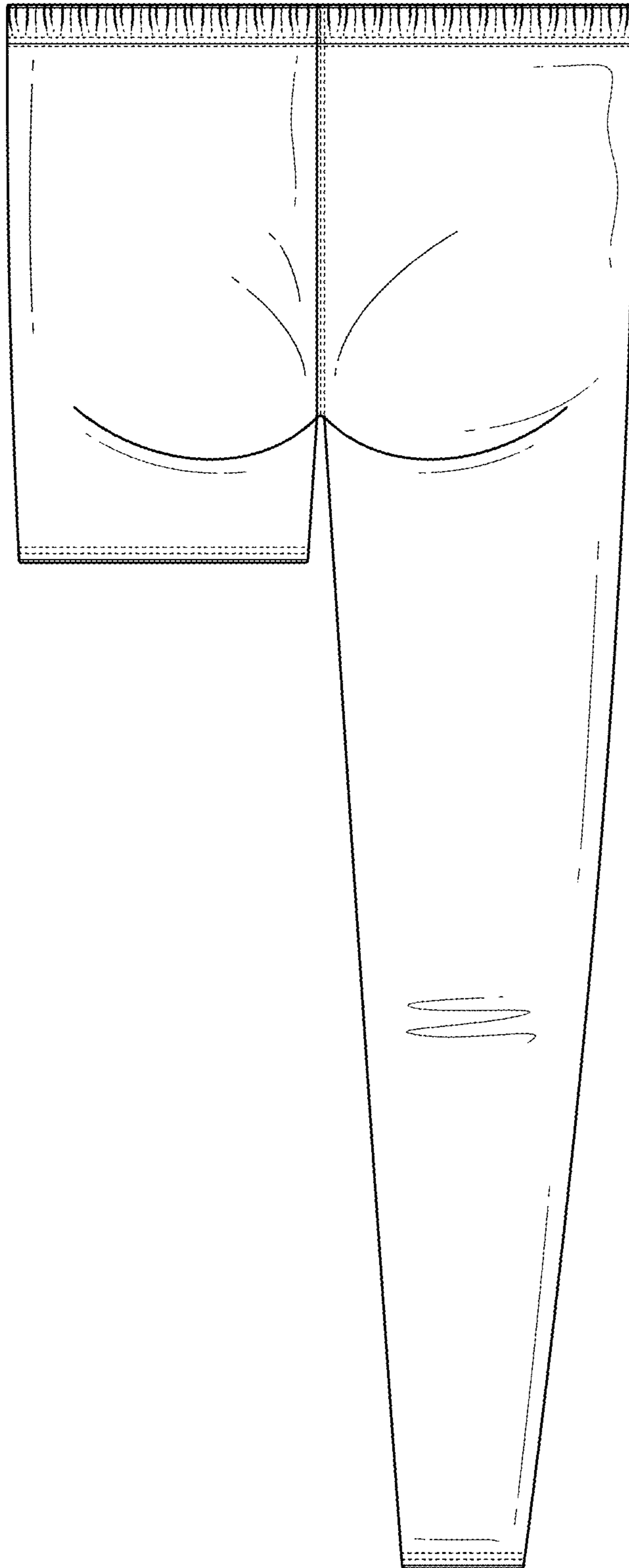

FIG. 3

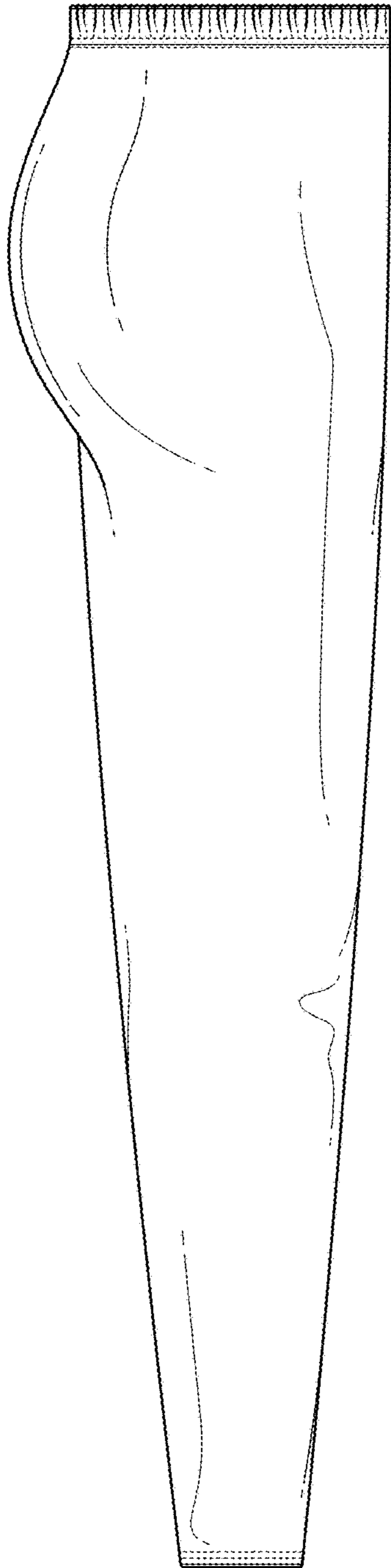

FIG. 4

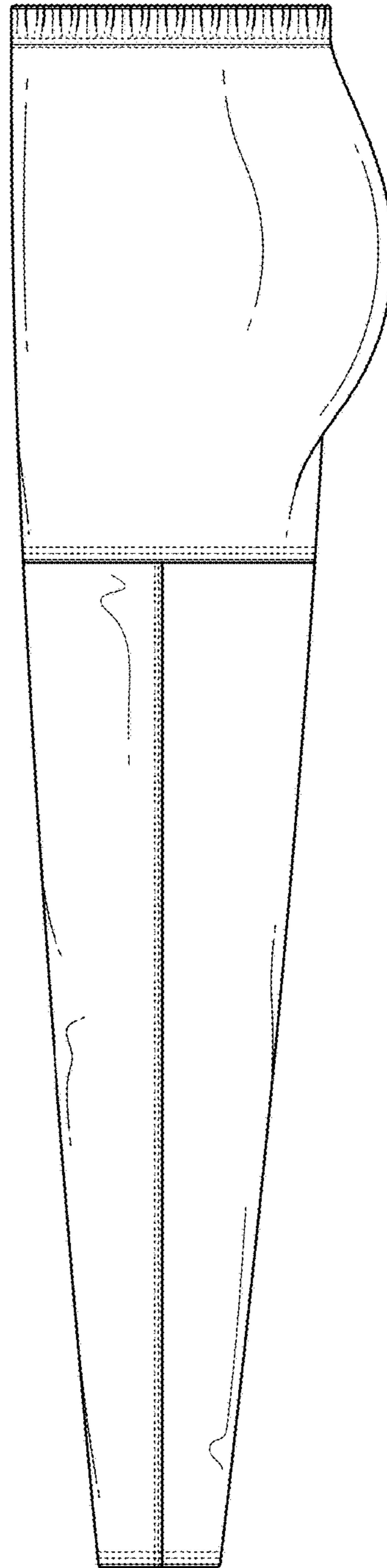

FIG. 5

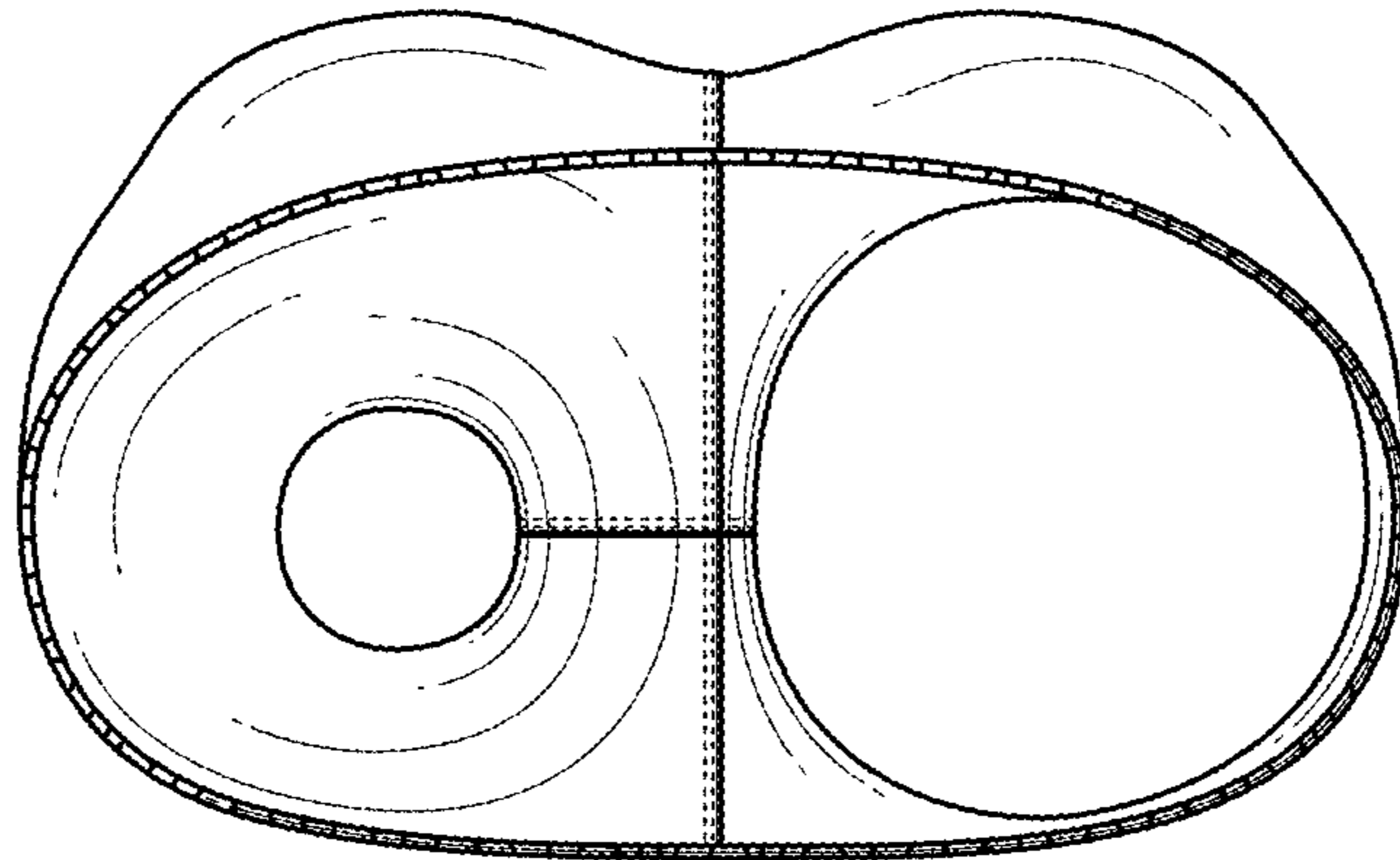

FIG. 6

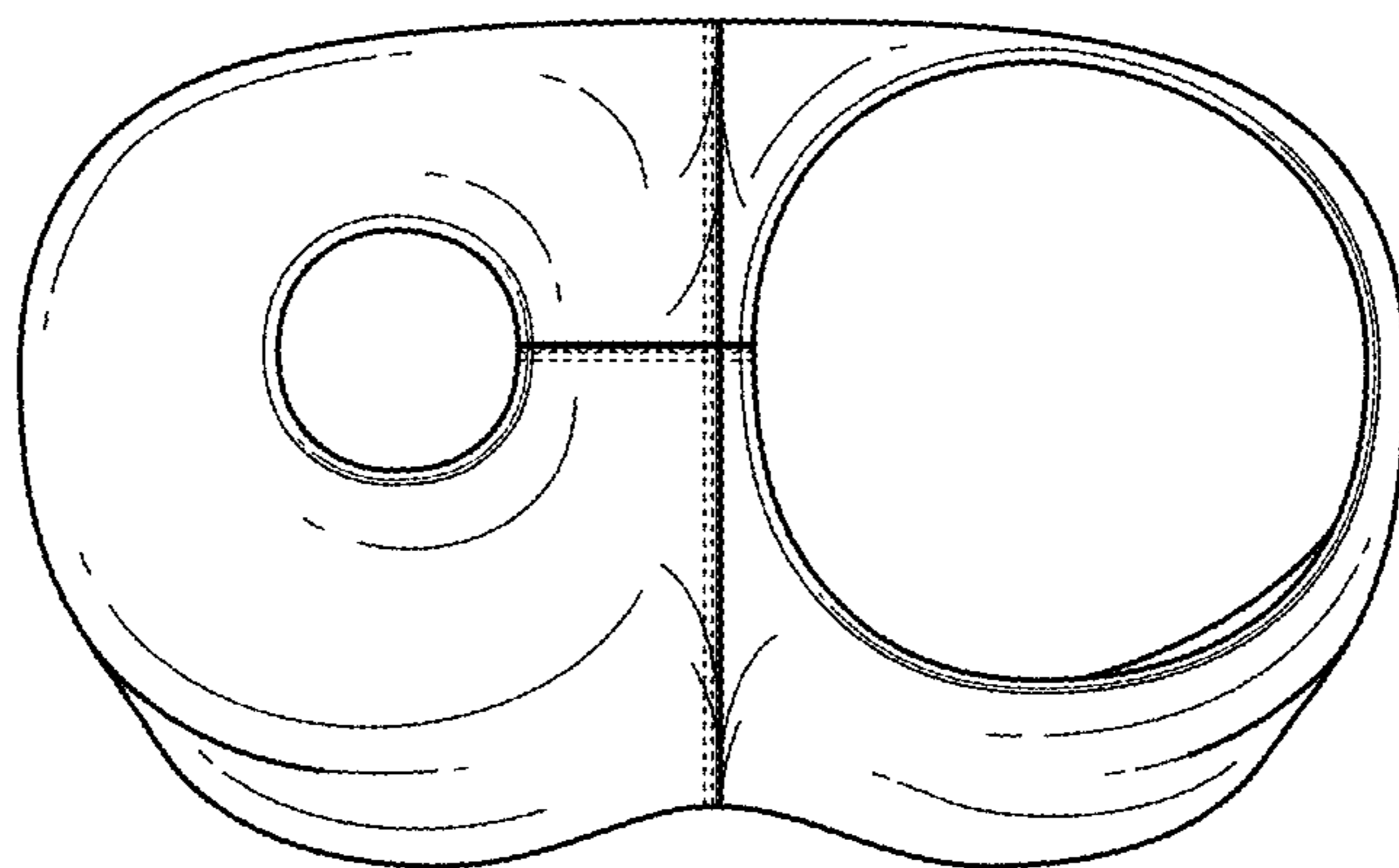

FIG. 7

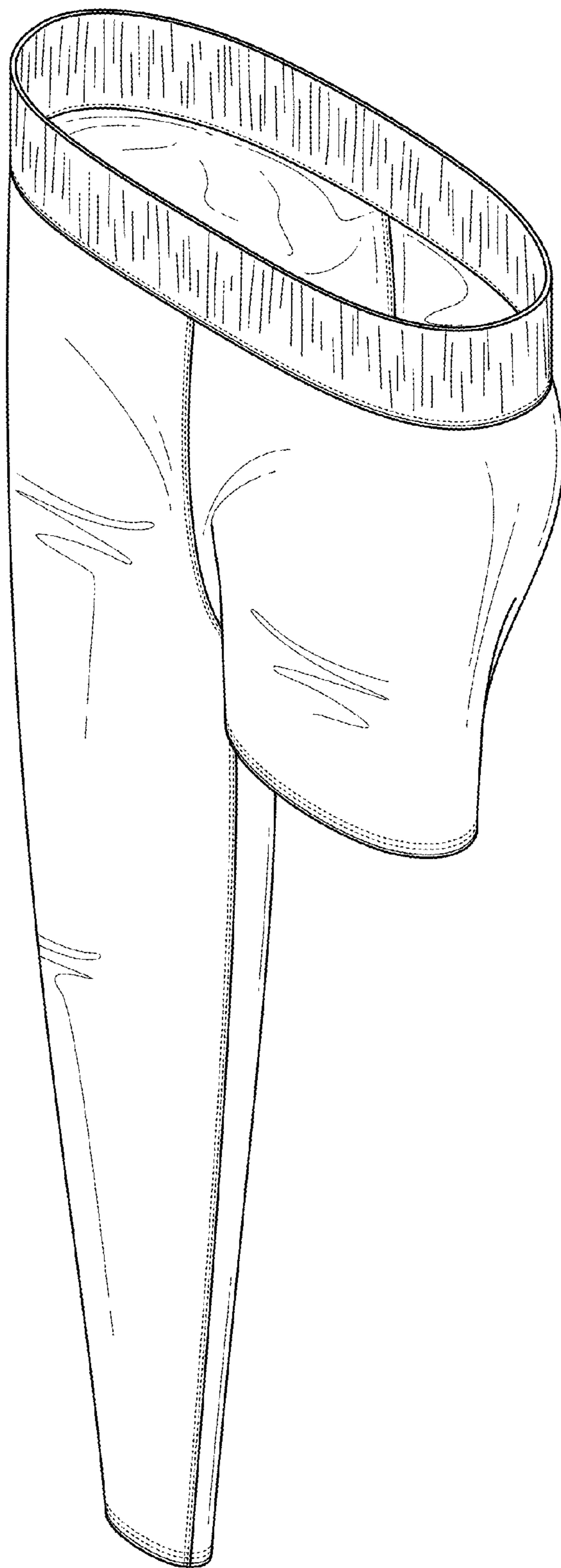

FIG. 8

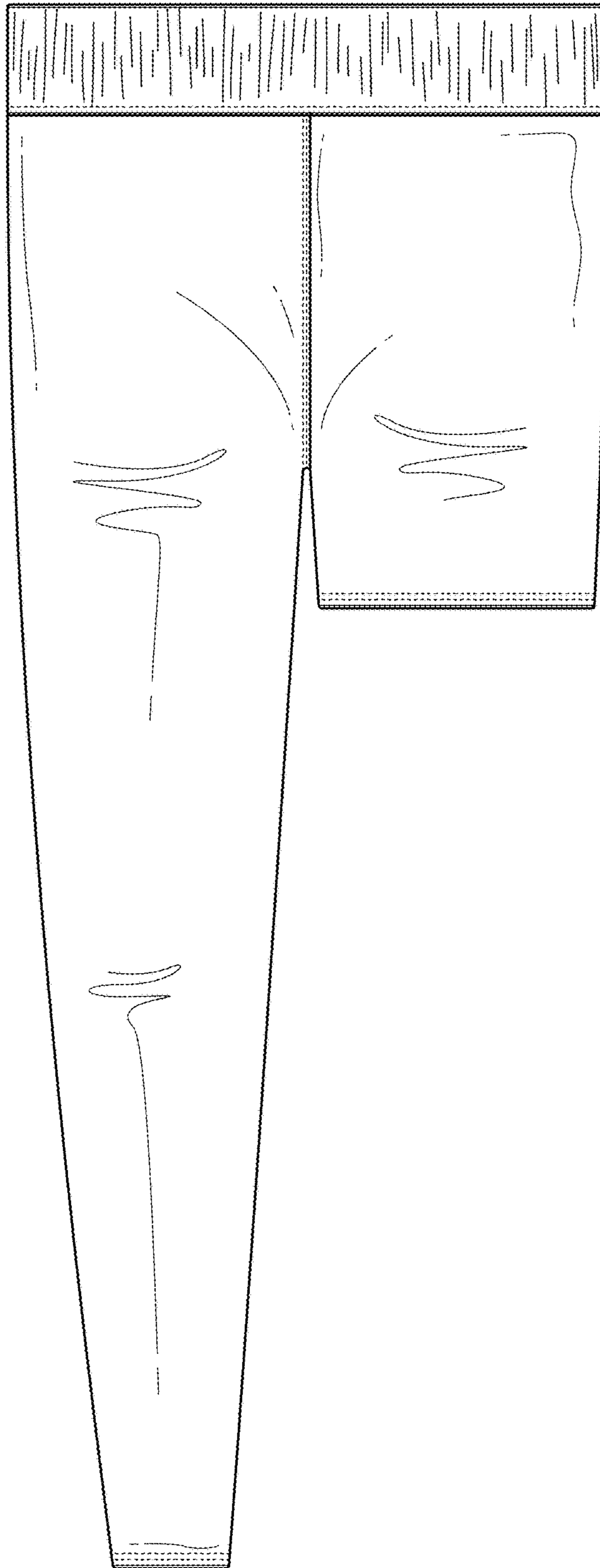

FIG. 9

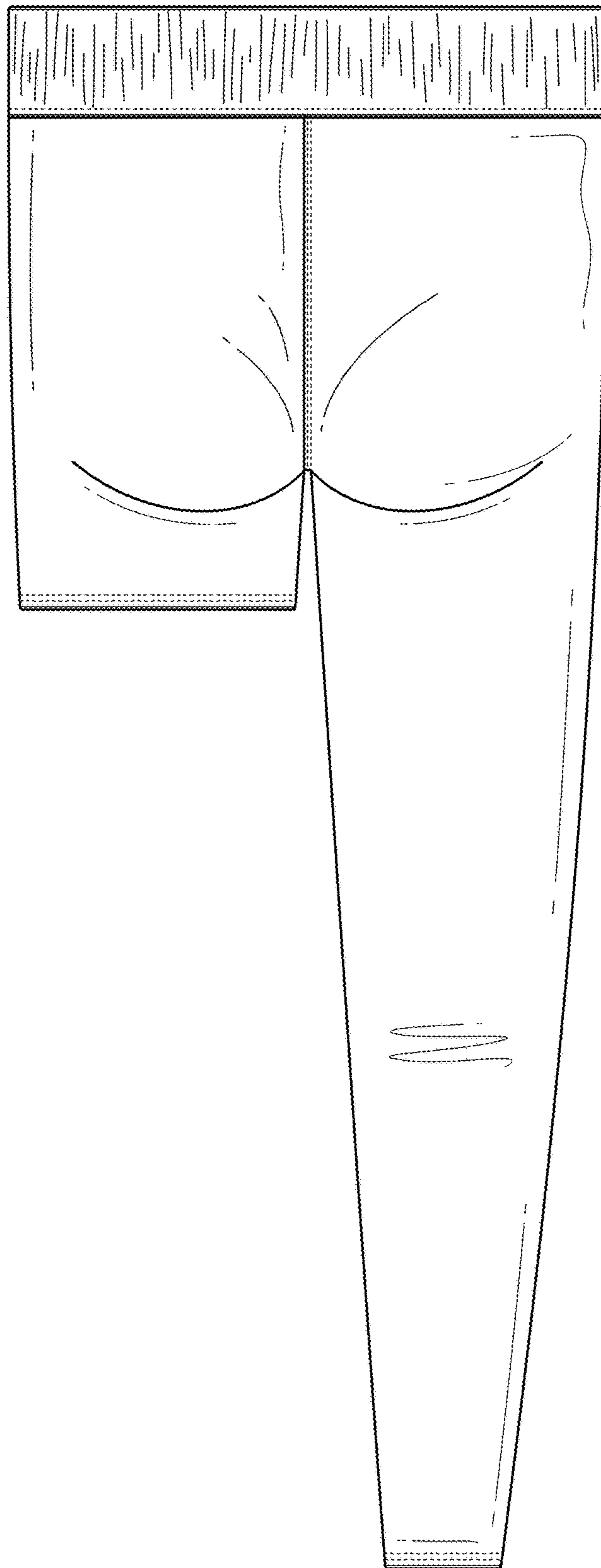

FIG. 10

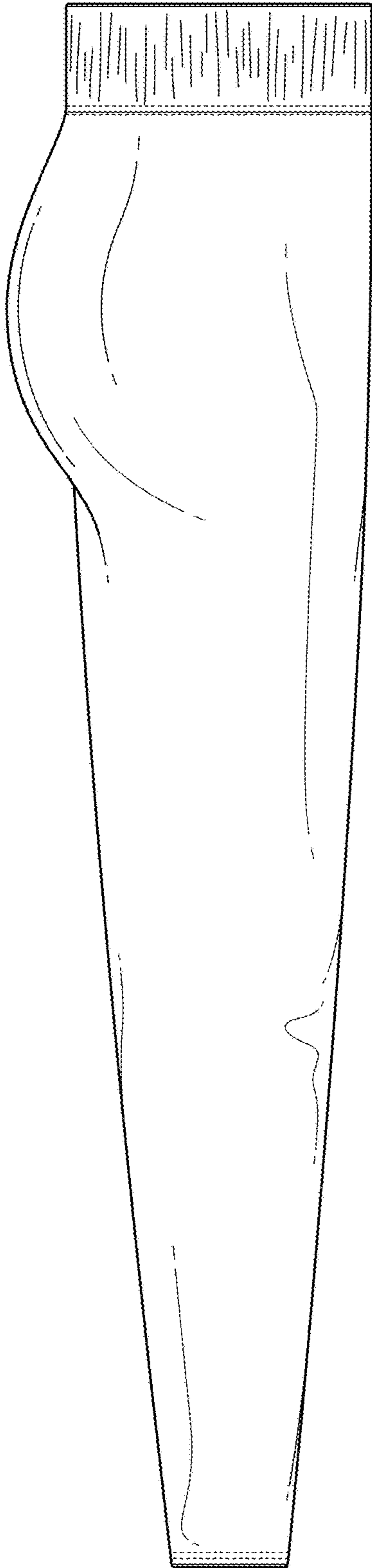

FIG. 11

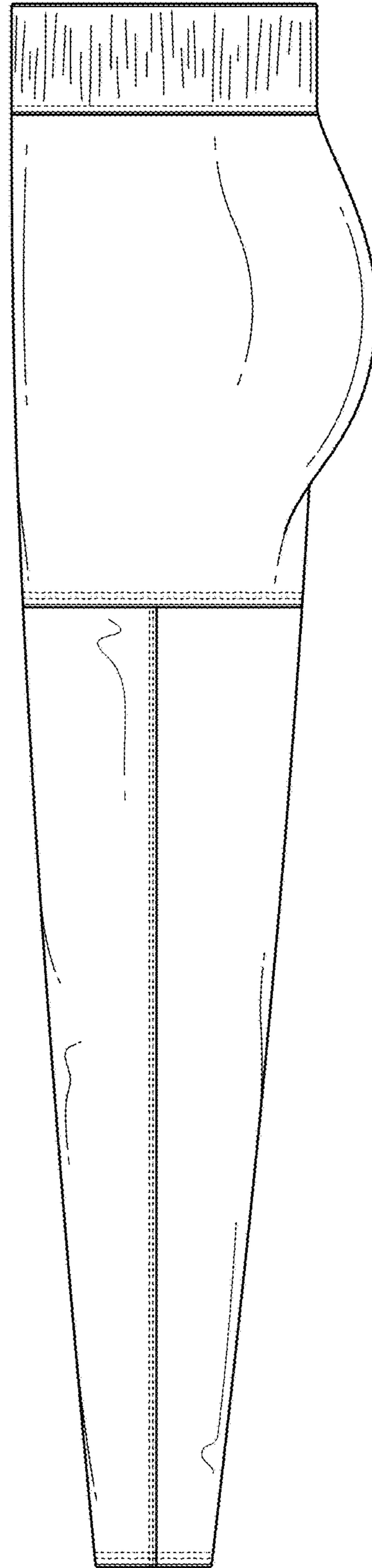

FIG. 12

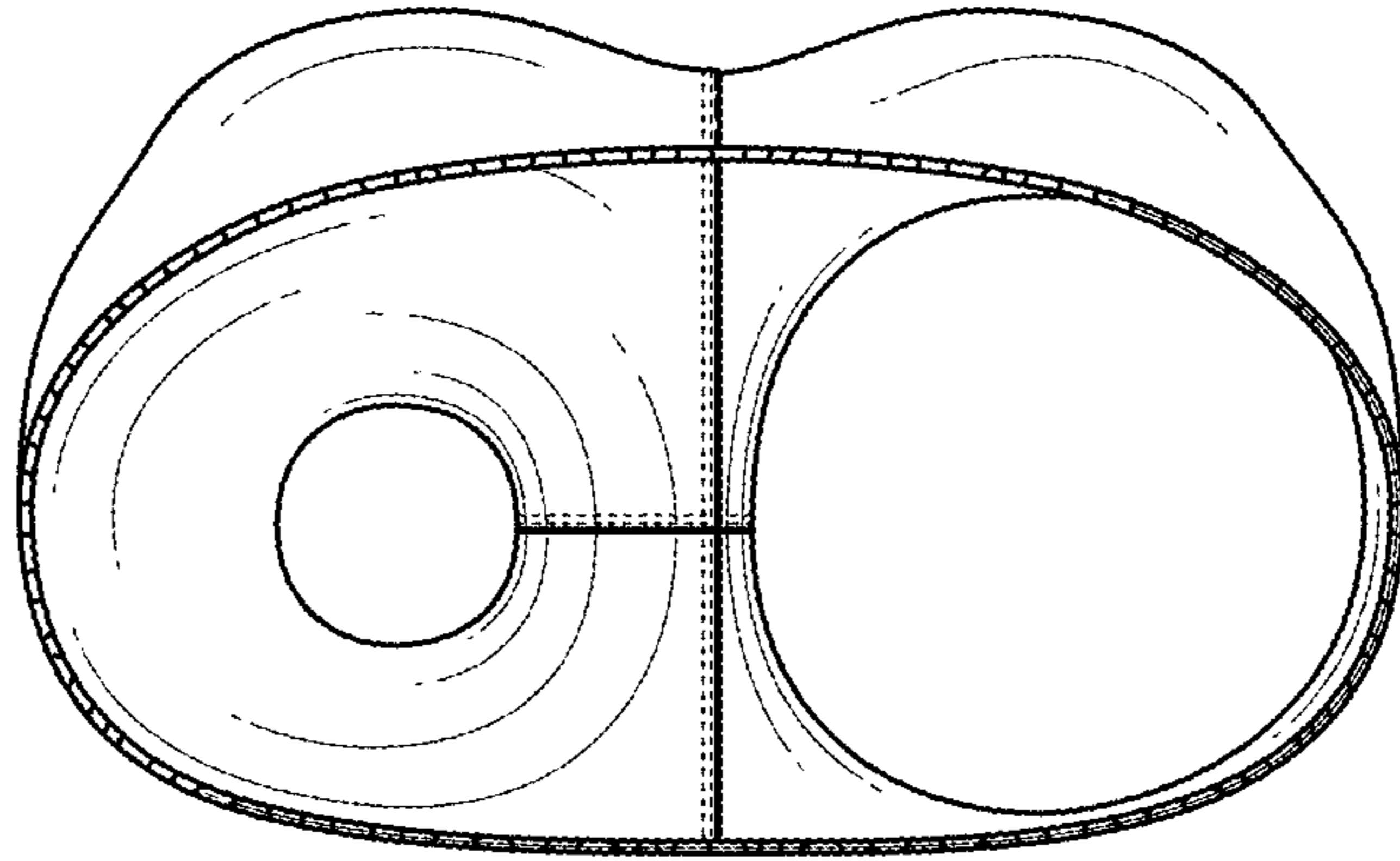

FIG. 13

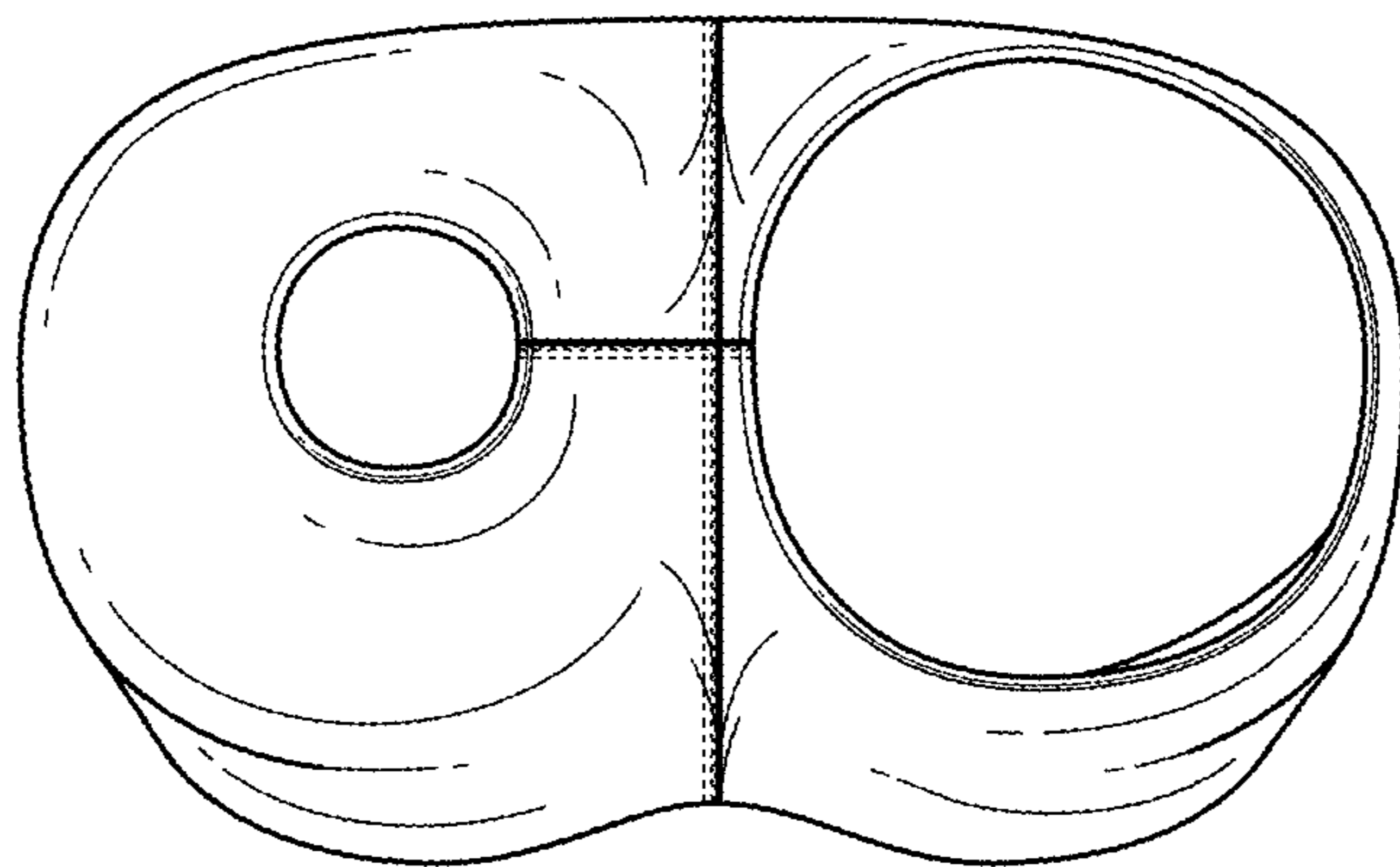

FIG. 14